

RAYBLADE™



SEGA®

It's your against the creatures of the evil Bydo Empire! Pilot the supersecret R-9 fighter spacecraft through waves of aliens and their deadly war machines.

Loading Instructions: Starting Up

- 1) Make sure that the power switch is OFF.
- 2) Insert the game cartridge in the Power Base (shown below) as described in your SEGA SYSTEM manual.
- 3) Turn the power switch ON. If nothing appears on the screen, turn the power switch OFF, remove the cartridge, and try again.
- 4) At the title screen, press Button 1 to start the game.

IMPORTANT: Always make sure that the Power Base is turned OFF when inserting or removing your Sega Cartridge.

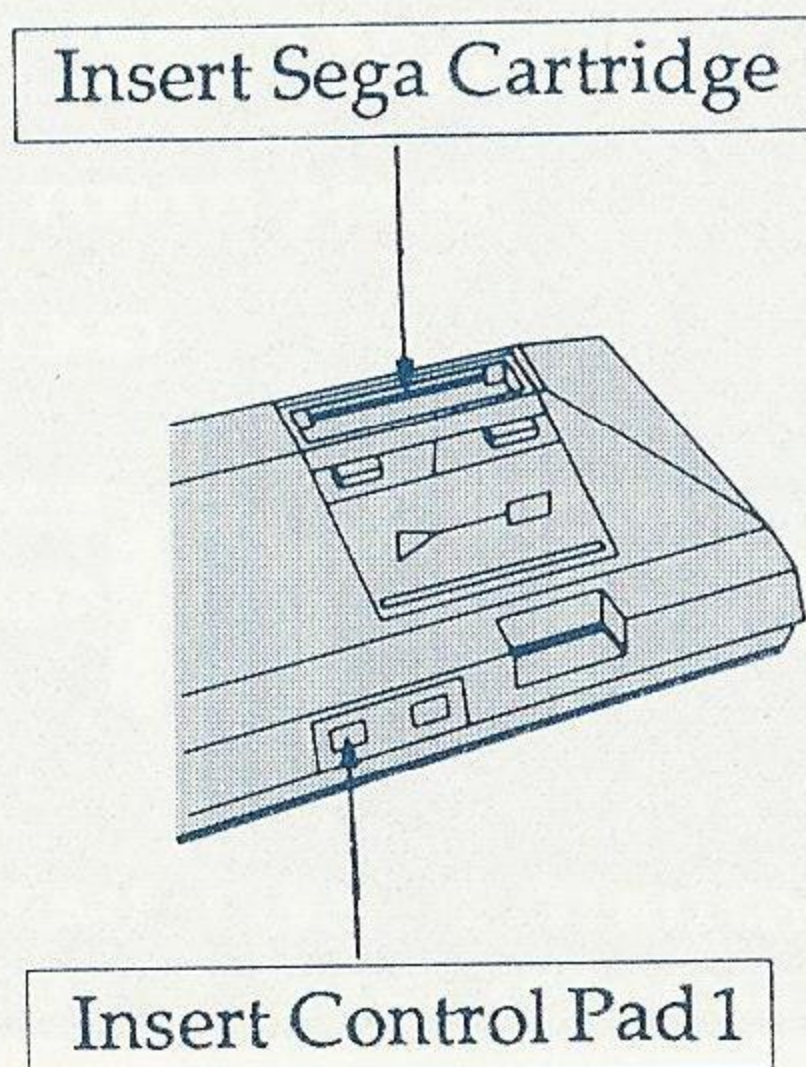

R-Type

They came from a dimensional plane clear across the galaxy, wreaking havoc and chaos from star system to star system. With an evil that smothers all resistance with fear and terror, the horrid creatures of the Bydo Empire are now knocking on Earth's front door.

The Earth Defense League has one ray of hope to stop the wave of terror: R-9, a supersecret spacecraft capable of striking the enemy in their own dimensional plane. When flown by a hot pilot like you, the R-9 can rip through bug-eyed monsters faster than a light saber through butter. But the horrendous creatures of the Bydo Empire are more than claws and pointy teeth; they've got some pretty impressive hardware, too, so stay frosty! Earth's future depends on you!

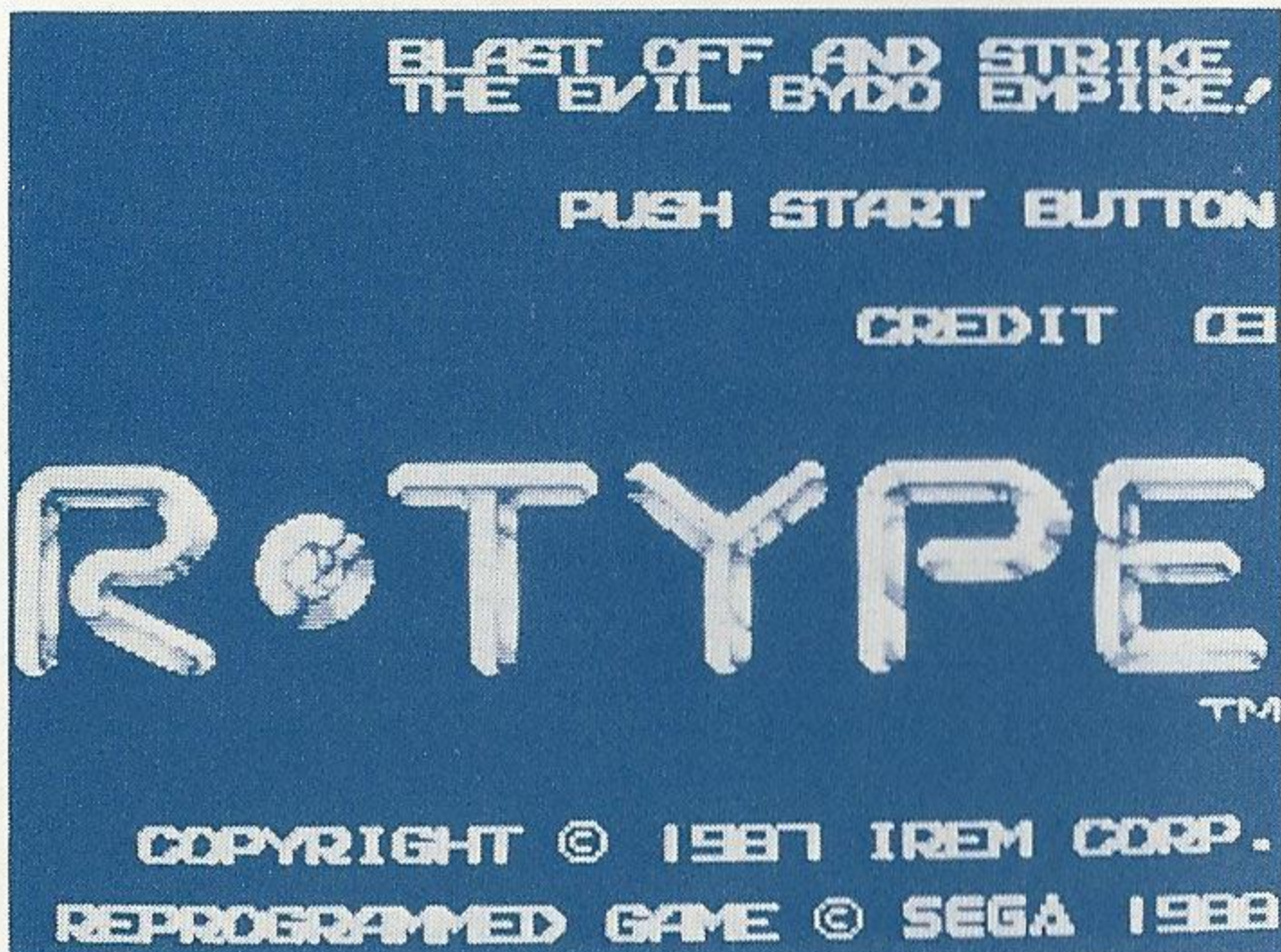

Taking Control

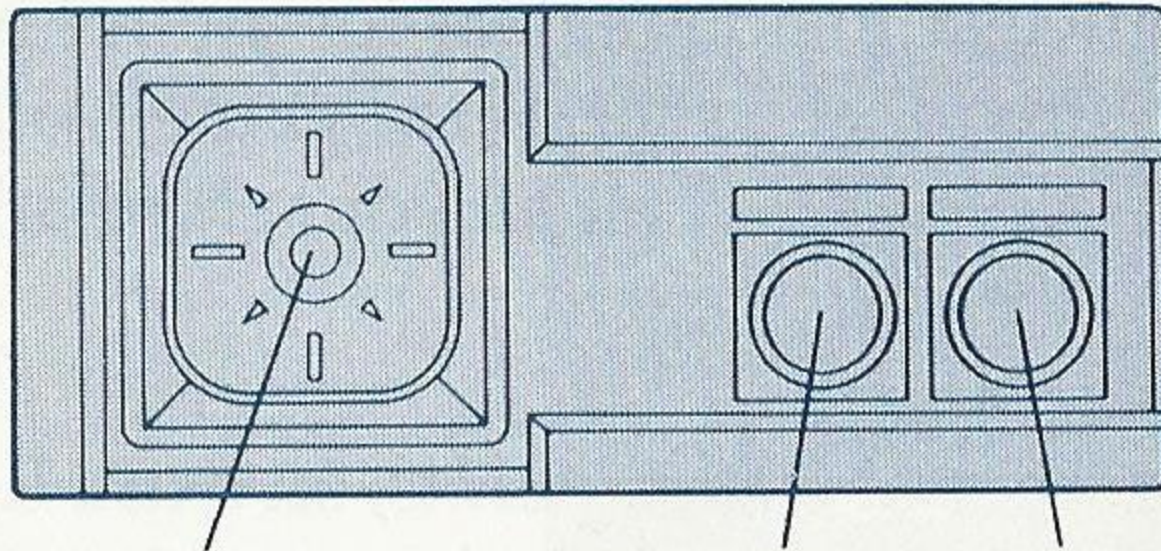

DIRECTIONAL
BUTTON
(D-Button)

BUTTON
①

BUTTON
②

D-Button: Moves your ship in eight directions.

Button 1: Fires your ship's energy weapons. Press repeatedly for rapid-fire pulse beam action, or hold the button before firing to activate R-9's laser blast. The longer you continue to hold the button, the more energy is accumulated and the more destructive power unleashed.

Button 2: To Merge and Separate Droid units, valuable additions to your ship that are acquired during the game.

Your Ship: The R-9

R-9 is Earth's most advanced and deadly spaceship. It is equipped with a nuclear fusion reactor for unlimited propulsion and weapons fire. At the start of the game, you have three R-9's at your disposal. When all your ships are lost, the game is over.

When you reach a score of 50,000 points, an extra R-9 will be awarded. Other ships are awarded after reaching scores of 150,000, 250,000, 400,000, and 600,000 points.

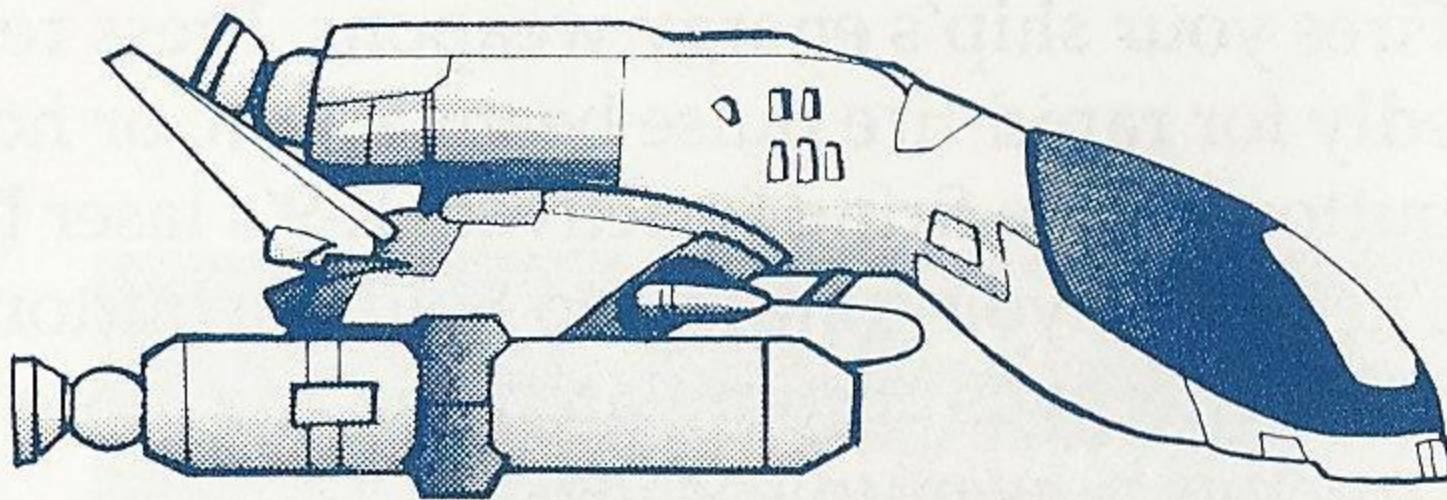

R-9

SPEED : 208 km/sec.

WEIGHT : 31.0 t

SPAN : 10.8 m

LENGTH : 16.2 m

HEIGHT : 5.1 m

Battle Stages

R-Type is played in eight different stages:

1: The Bydo Empire's
frontline base.

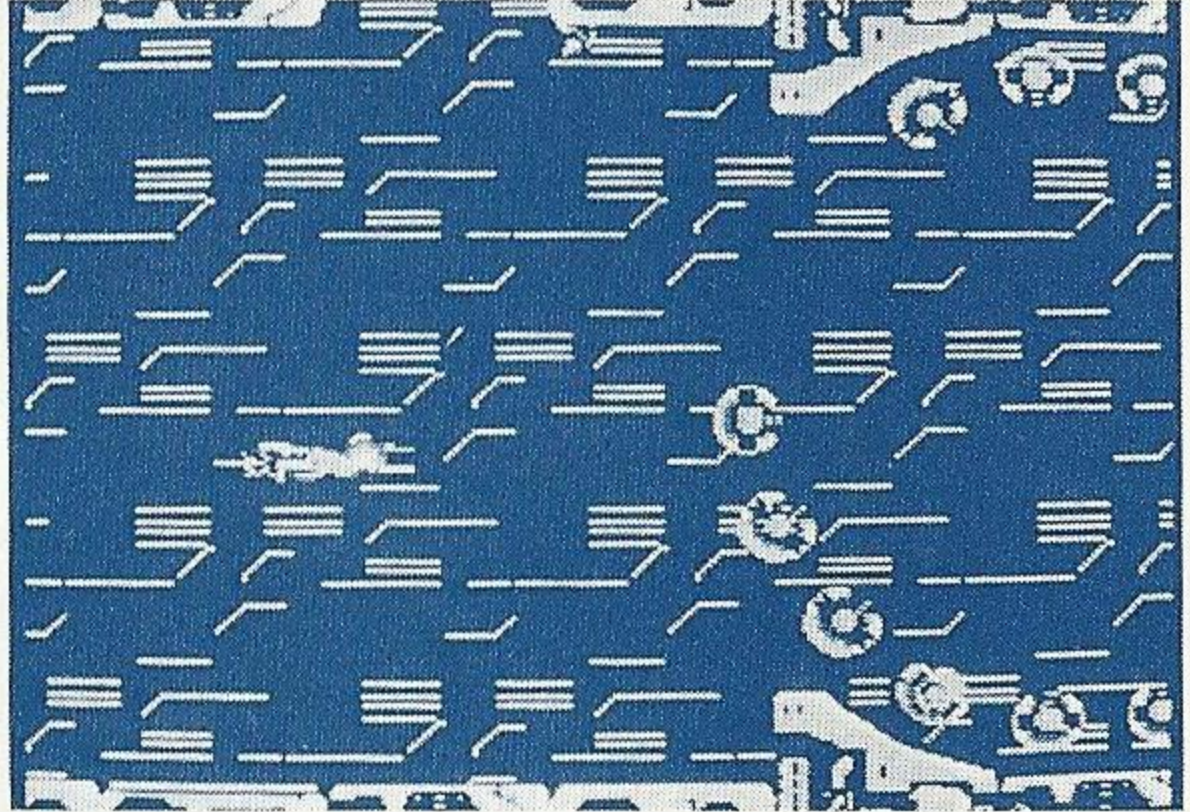

2: The Bydo caves.



3: The Mega battleship.

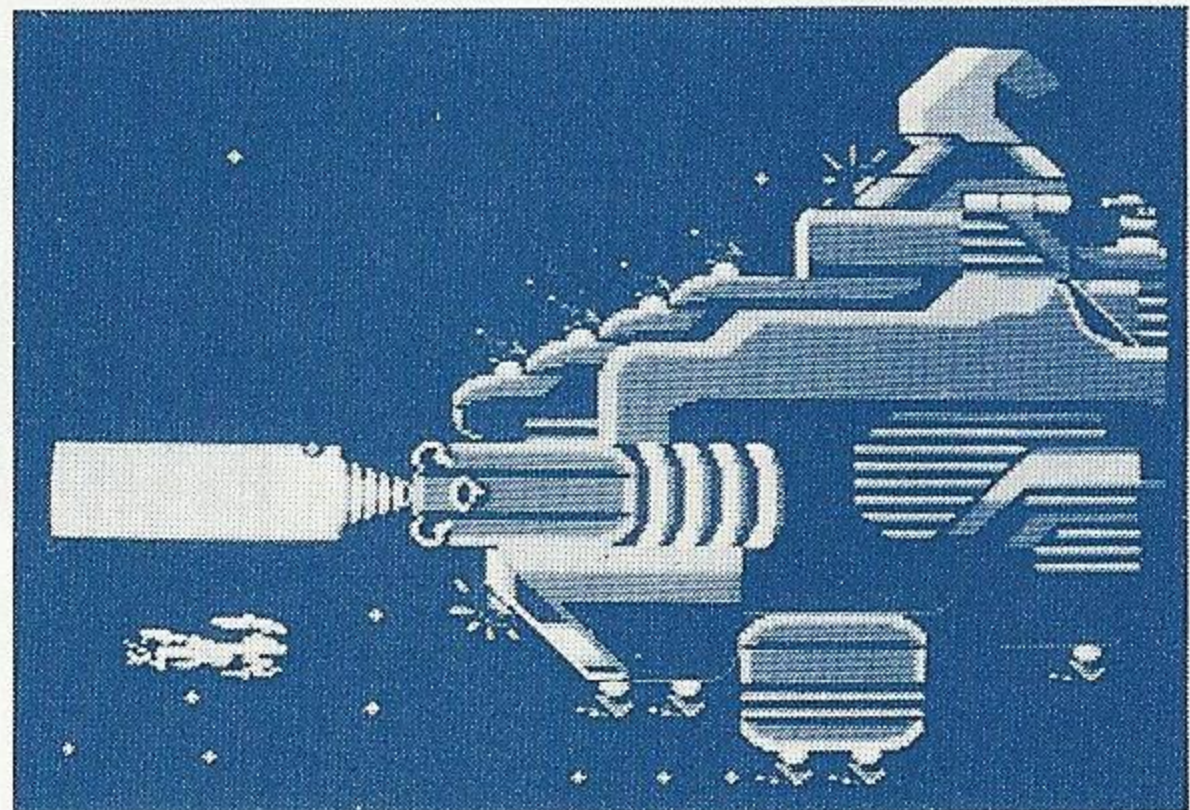

4: The Terrible Mechanical cells.

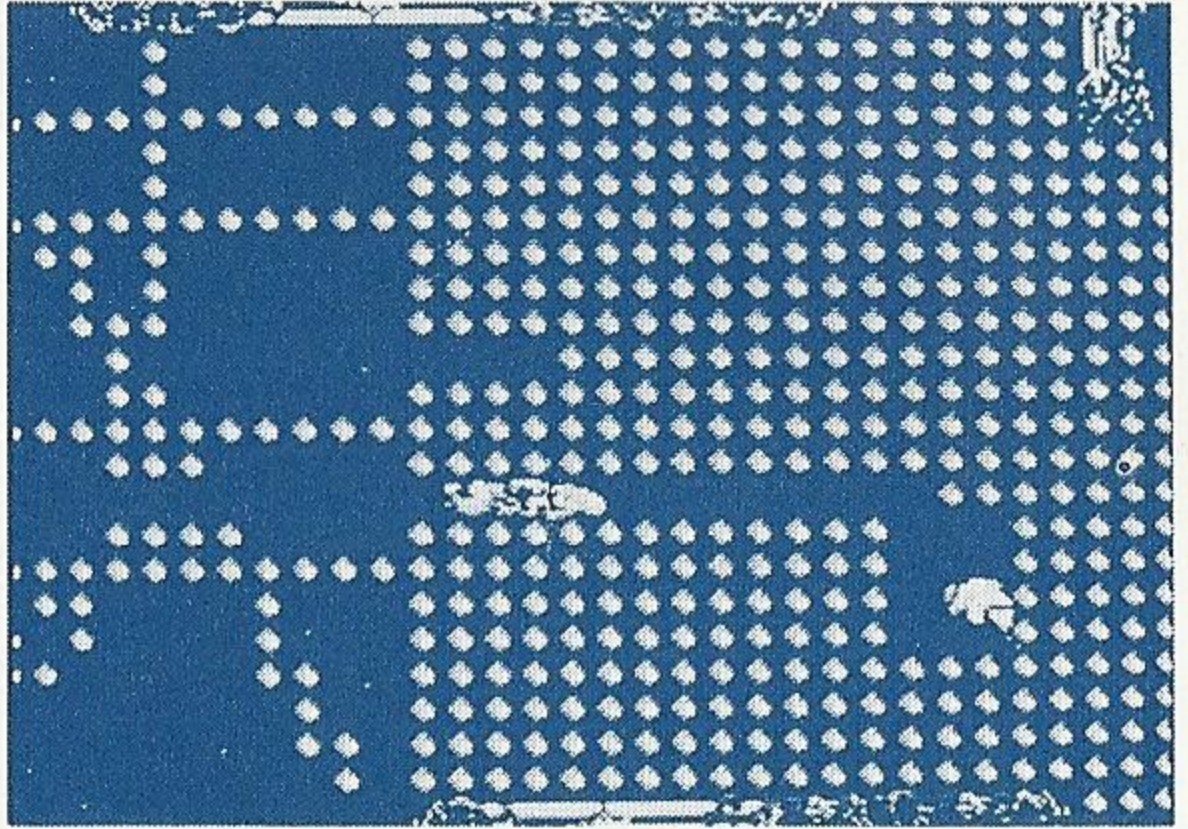

5: The underwater caves.



6: The warehouse labyrinth.

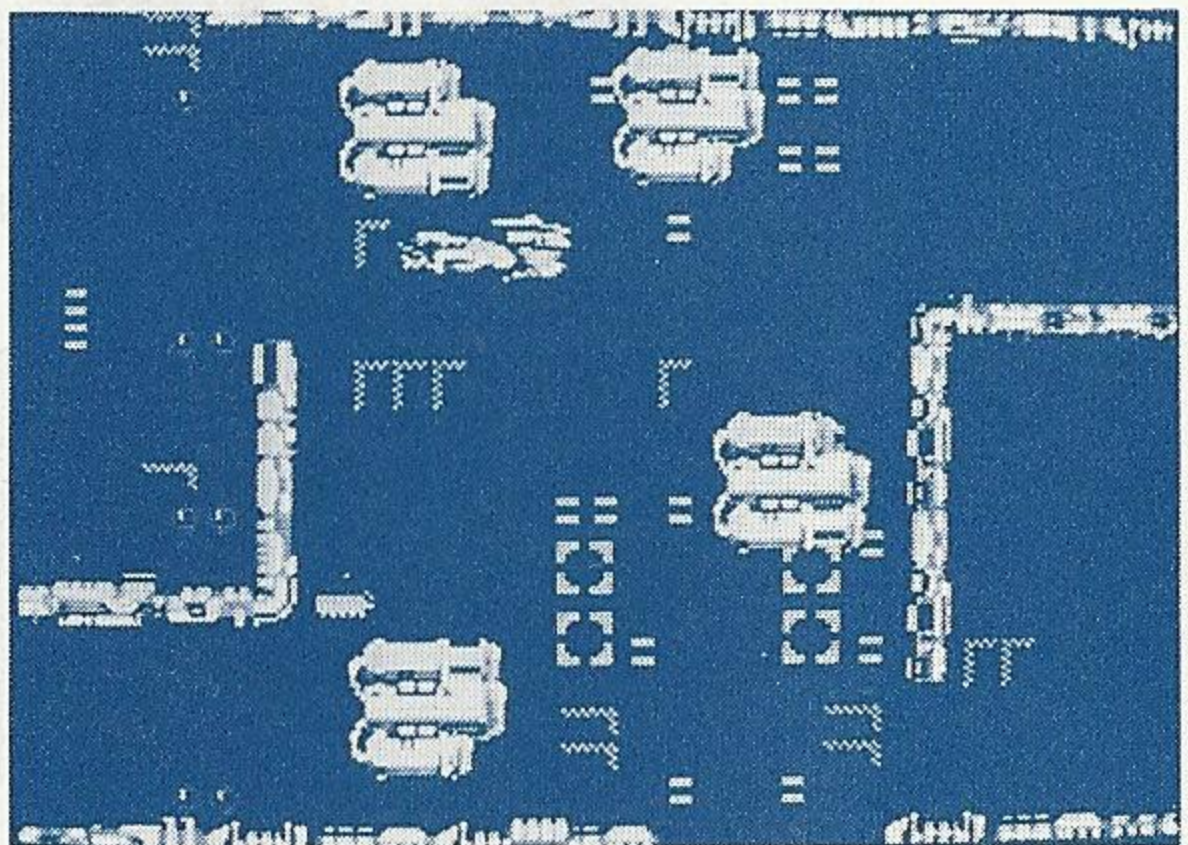

7: The eroding city.

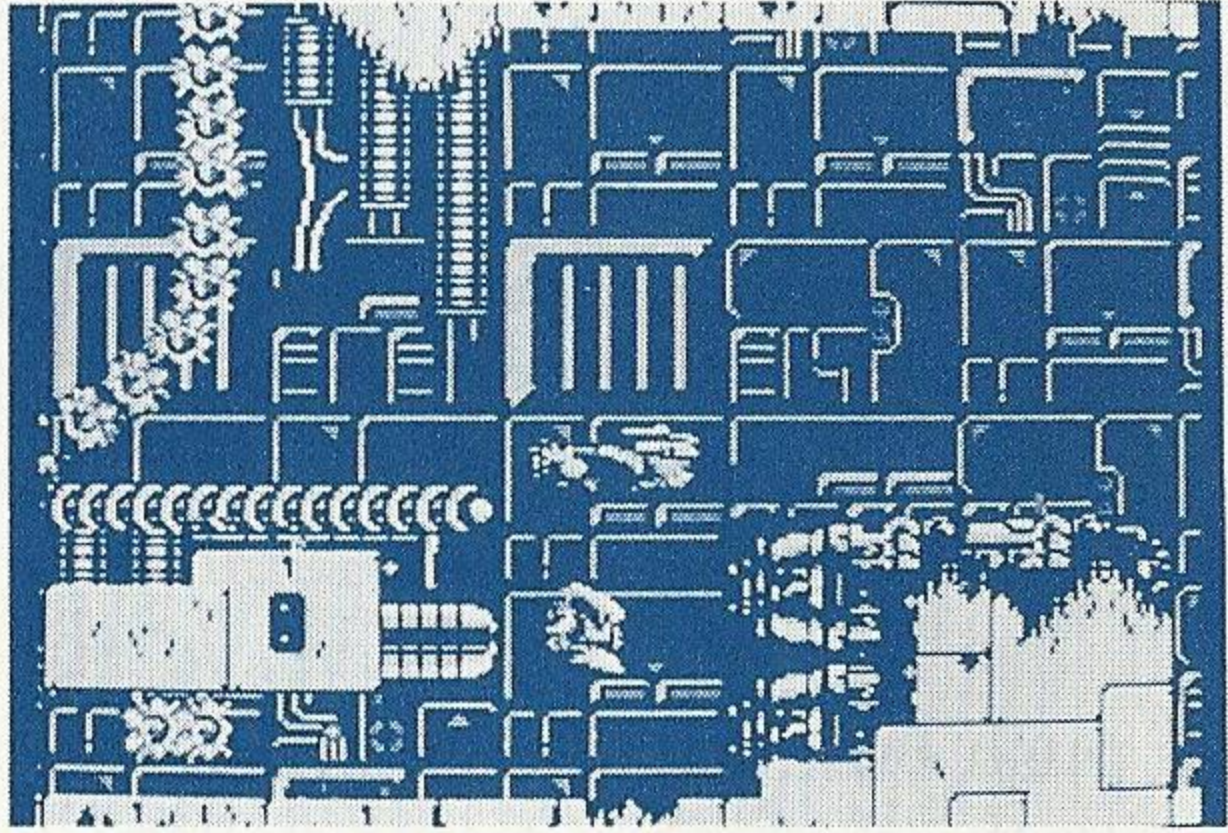

8: The Bydo Empire Home Base.



At the end of each stage is a tough boss alien protecting entry into the next level. You must defeat them to advance. By defeating the last creature at the end of level 8, you win the game and save the universe!

Your score and the number of remaining R-9 spaceships will be displayed at the clearing of each stage, but not during the battle scenes.

Droid Units

When Bydo POW Armor is destroyed, it releases Droid Units which look like metal spheres. To obtain Droids, fly through the blue force gem and the Droid will appear from the left side of the screen.

If you push Button 2, the Droid will advance toward R-9 and join with the ship. Droids shoot pulse beams in tandem with R-9, and cannot be destroyed. You can place the Droid in either the front or the rear of R-9 by steering your ship, wherever it will help you destroy the enemy best. Droids will absorb some types of enemy shots.

By pushing Button 2 again, you can separate R-9 from the Droid for an effective battle formation, depending on the enemy units attacking you. If the Droid gets a bit too far away, push Button 2 and bring it up close. The Droid will also fly on a diagonal line from you. You can use this ability to shoot a path of destruction through the enemy, or to concentrate fire on specific targets!

Laser performance and destructive power of the Droid change depending on how many Droid gems units you obtain (one, two, or three), and whether or not the Droid is attached to R-9.

After obtaining the second Droid gem, the Droid is able to shoot pulse beams diagonally up or down when separated from R-9. When the third Droid gem is obtained, it will shoot pulse beams up/down and diagonally up/down when separated from R-9.

Powering Up

To have any chance at all of killing the Bydo Empire's nastier creatures, R-9 needs to "power up." Power Up parts also appear when you defeat Bydo POW Armor units. After shooting them, POW Armor units drop various "unit symbols," which you pick up by flying over them.

There are six different types of unit symbols.

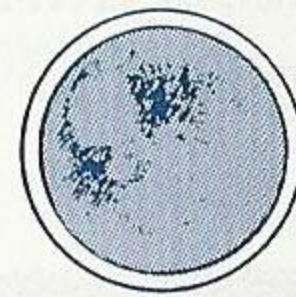
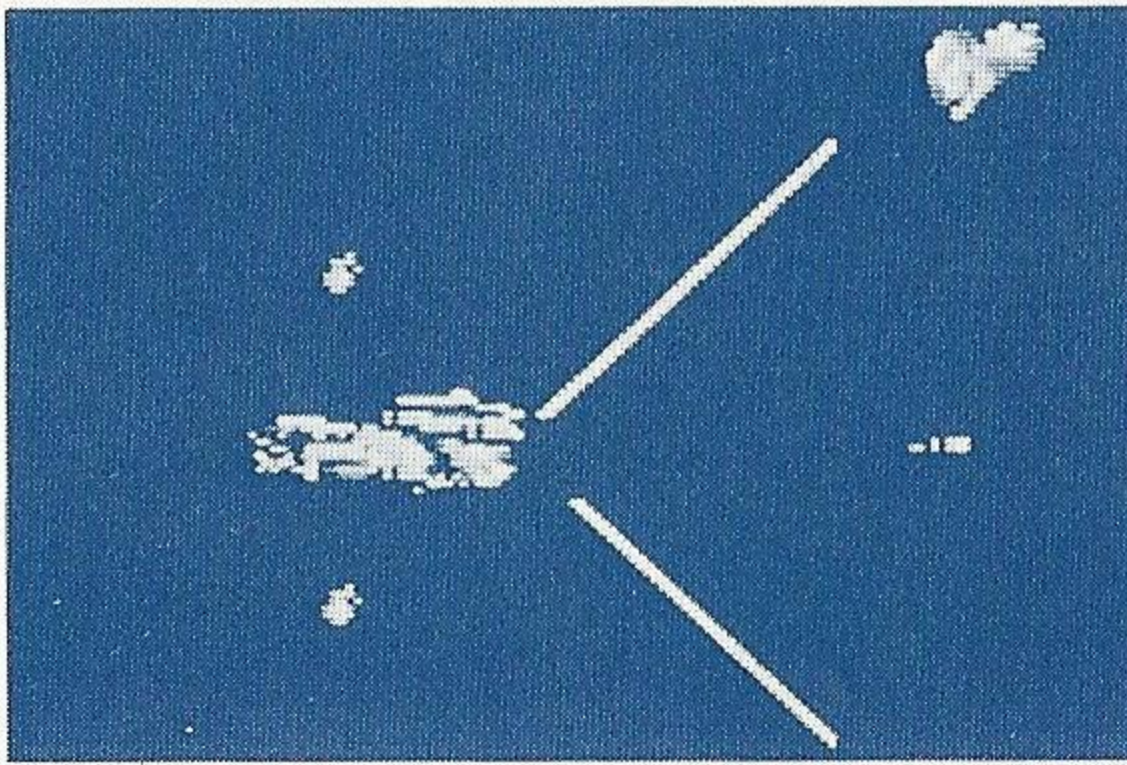

1: Reflecting Laser Force Units (blue)- Rather than firing in a straight line, this powerful laser beam ricochets off objects.

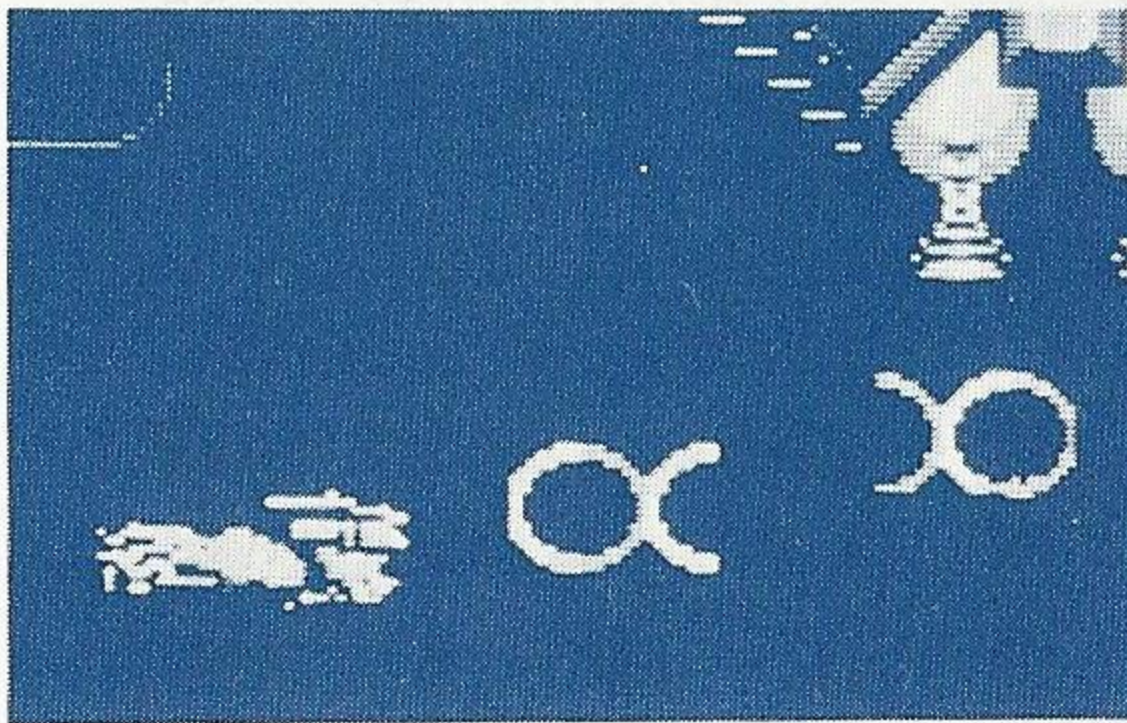

2: Antiair Laser Force Units (red)- This ring-style laser shoots in a straight line, but has the strongest demolishing power, since the width of the

ring is very wide, making it easy to hit the enemy.



3: Speed Units- Increase the speed of your R-9 ship each time it is obtained.



This weapon excels during fights with the Mega Battleship and during cave fights.



4: Antiland Laser Force Unit (yellow)- Shoots both top and bottom (up and down). When it hits an obstacle, it runs along the surface until it destroys an enemy in its path.



5: Twin Missile Units- Homing radar automatically guides twin missiles to the nearest target. They can hit two targets at once.

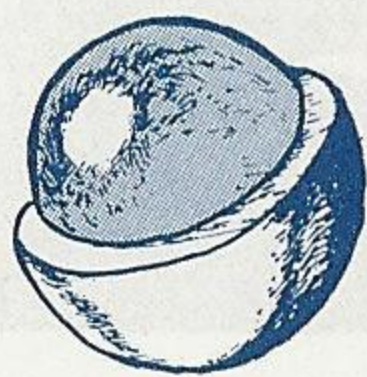
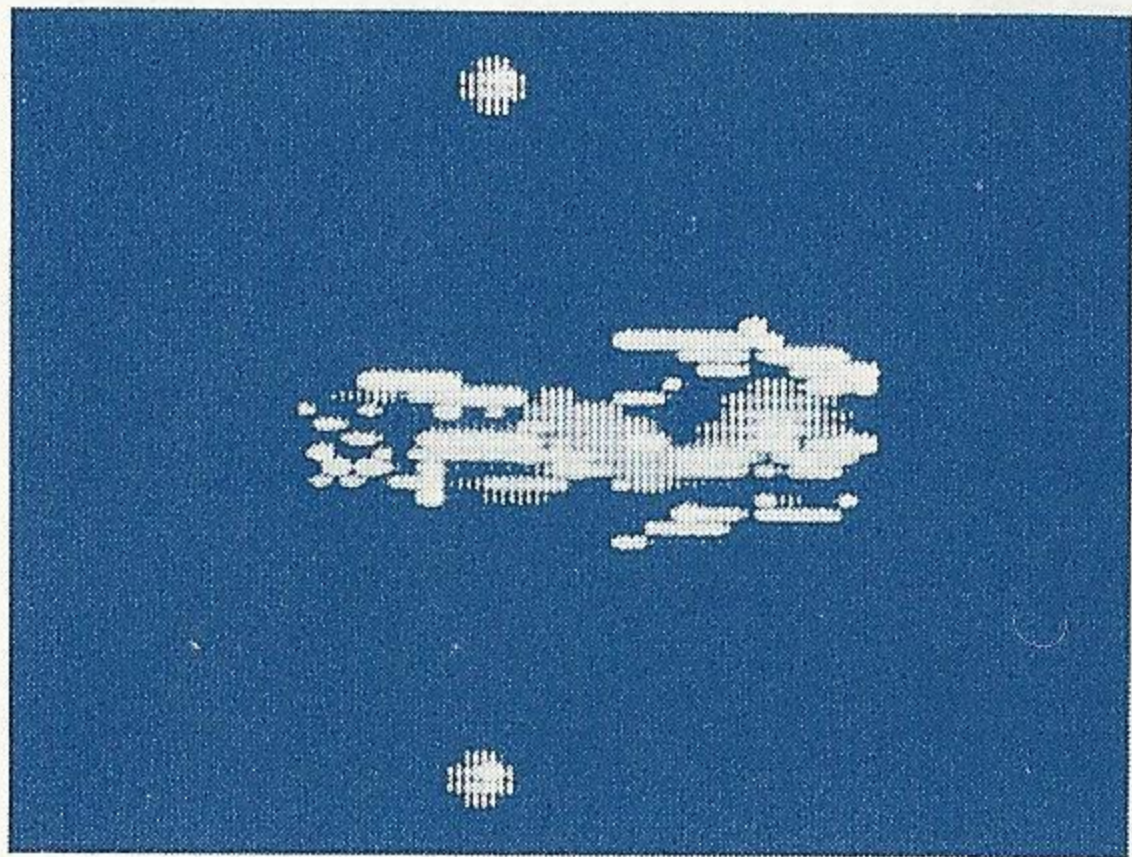

6: Bit Units- Up to two "Bits" (round power spheres that float above and below your ship) can be added to the R-9. They can shoot pulse beams, and kill the enemy when touched.

Villains of The Bydo Empire



Zipp

100 points.

Superspeed, moves from right to left.

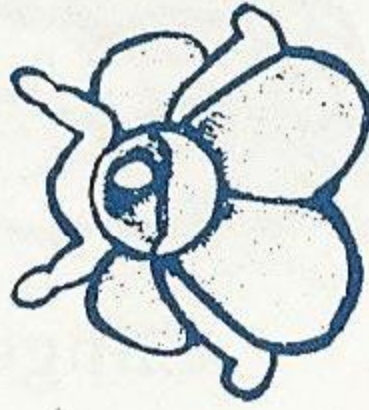

Bagut

200 points.

Attacks in formation.

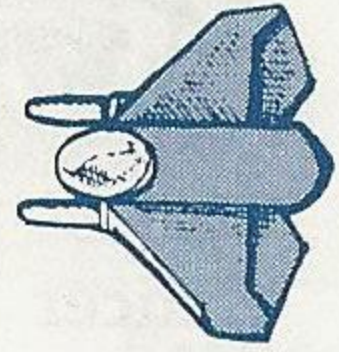

Manx

200 points.

Will attack in groups.

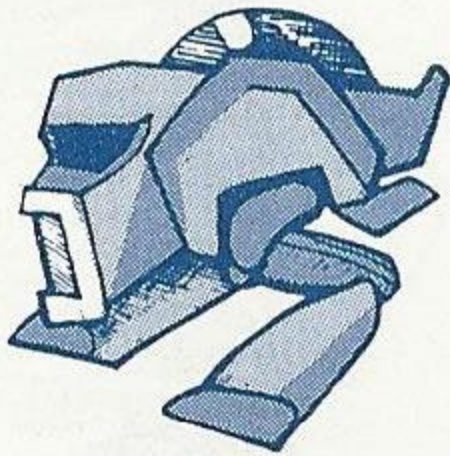

Skimmer

200 points.

Slides on the surface.

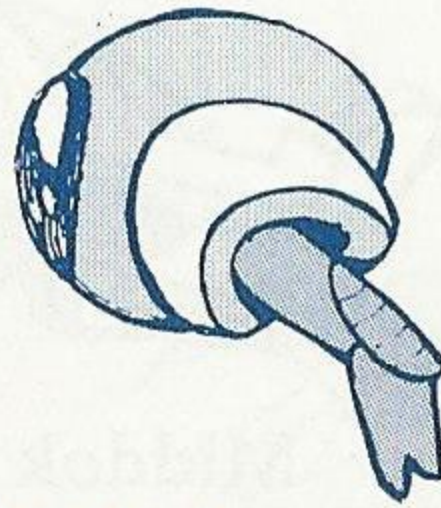

POW Armor

200 points.

Carries Power and Droid Units.

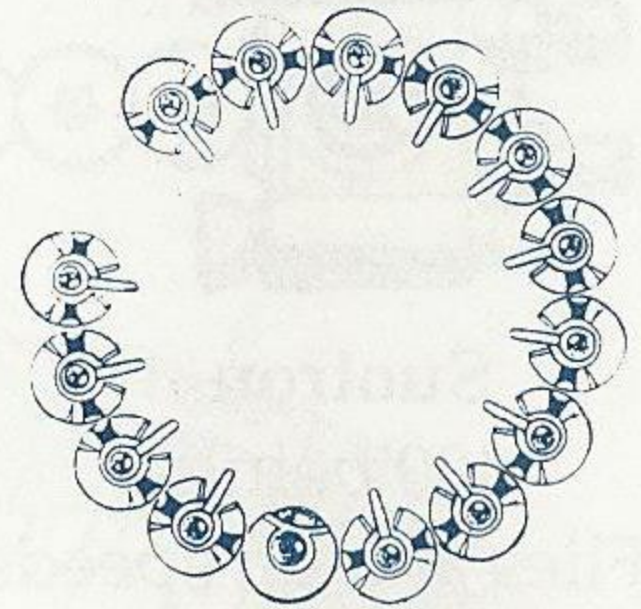

Gondolan

200 points.

15 Cannons that rotate.

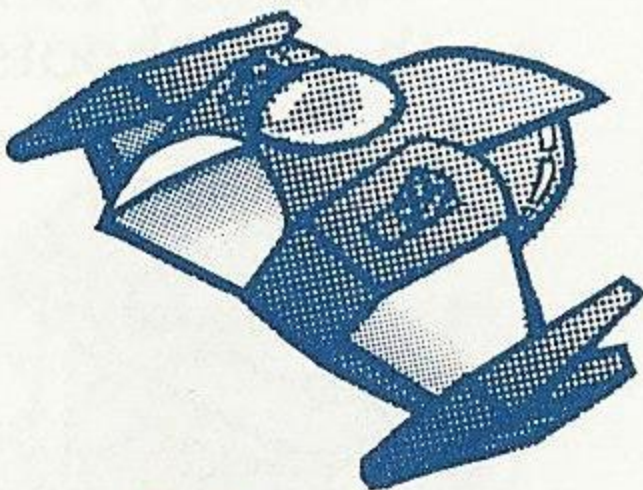

Fritz

200 points.

Advances from right to left in a straight line.



Mikkun

200 points.

Appears from top and bottom of walls.

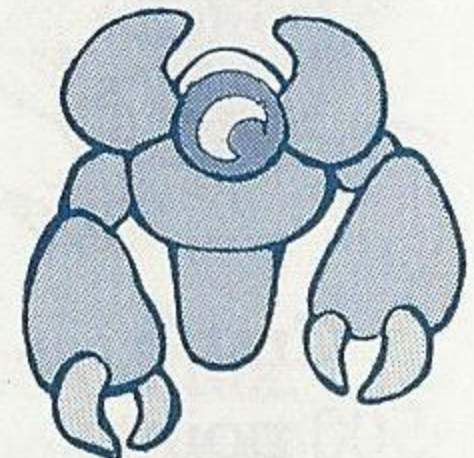

Getrudo

200 points.

Eats Mechanical Cells.

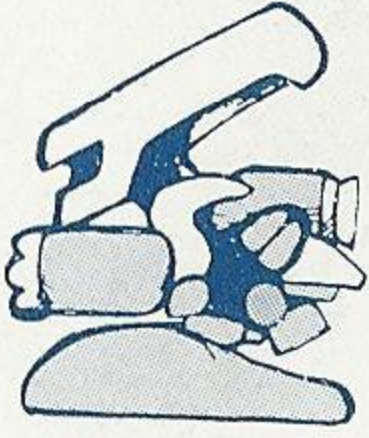

Cancer

300 points.

Matches the height of R-9 and attacks.

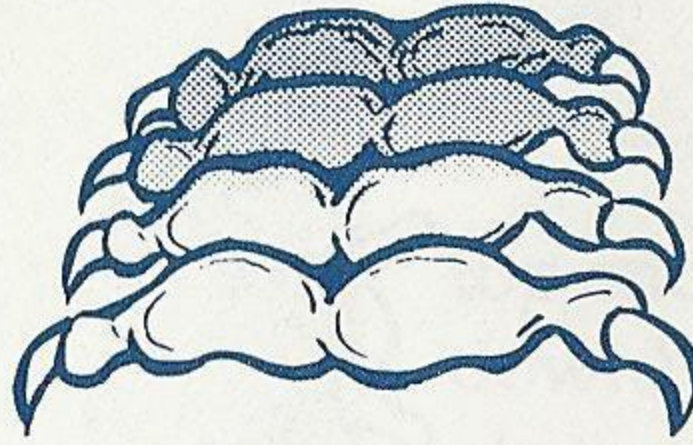

Clinger

300 points.

Moves in line with wall and shoots.



Basua

300 points.

Chases R-9.

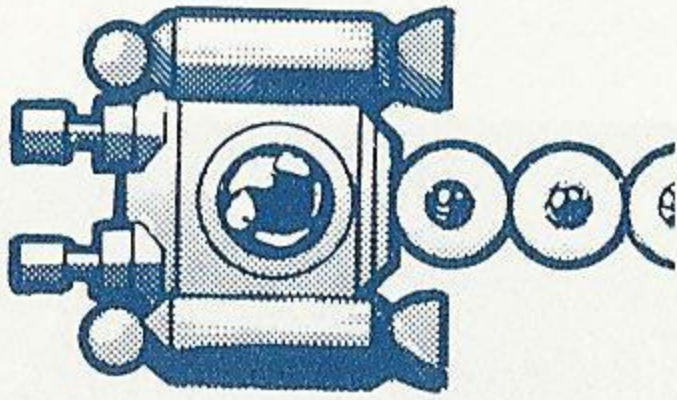

Suotron

400 points.

Flies at high speeds while shooting Mechanical Cells.

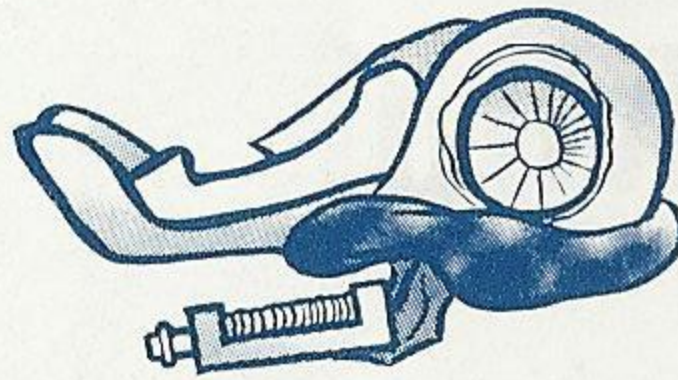

Middok

400 points.

Shoots continuous stream of laser beams.

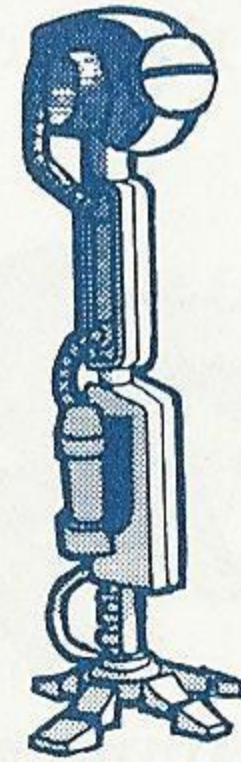

Sonar

400 points.

Appears from the center of earth and shoots.

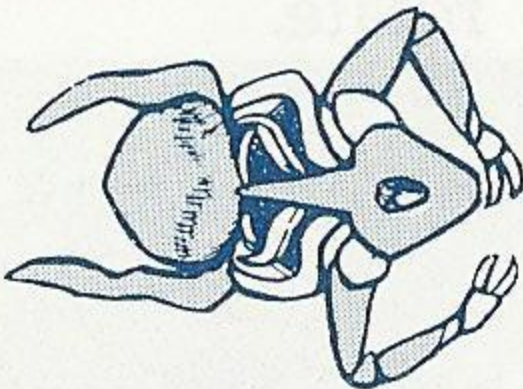

Crabb

500 points.

Appears from inside the ground and swims in the air.

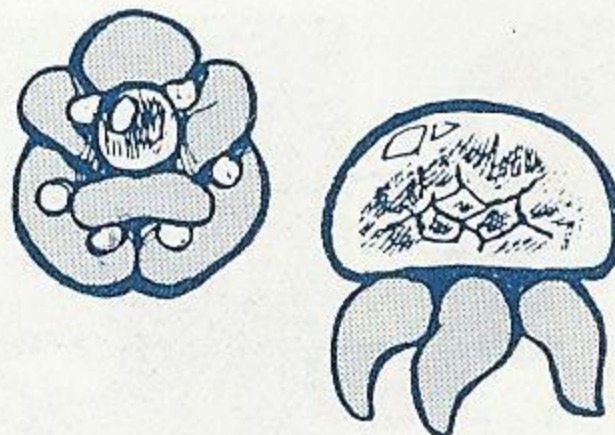

Zoid

500 points.

Changes body appearance and attacks.



Skianto

500 points.

Shoots laser blasts.



Rocker

500 points.
Shoots missile
barrages.

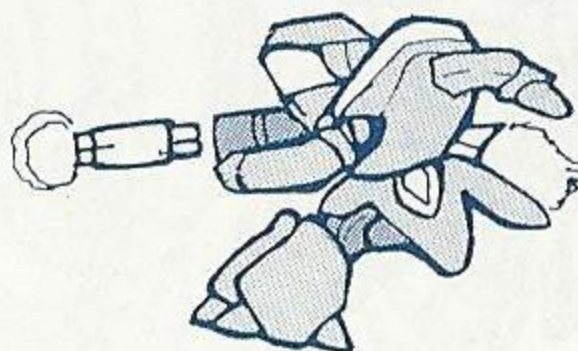

Dauber

800 points.
Shoots attacking
missiles in large
quantities.

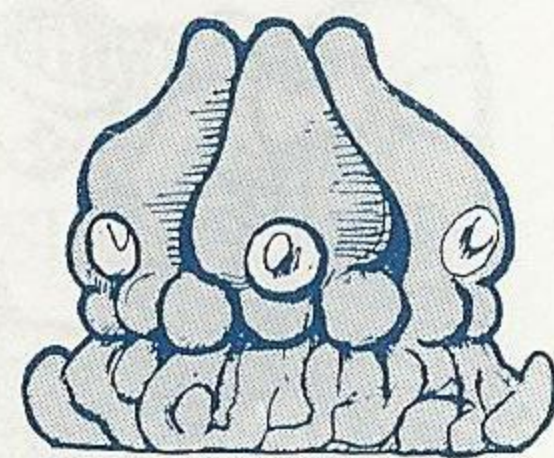

Barucca

800 points.
Discharges
Zoids.

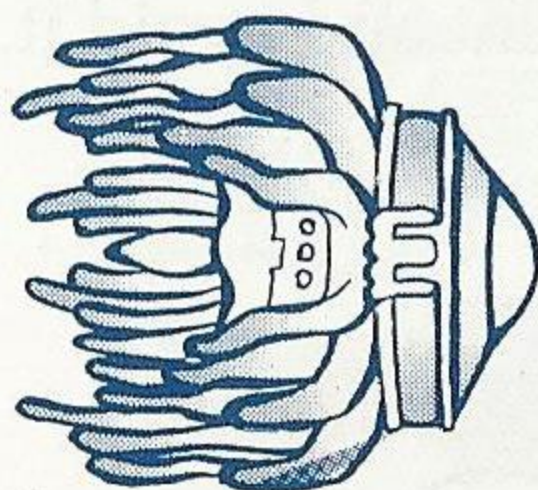

Jidak

800 points.
Shoots continu-
ous stream of
laser beams.

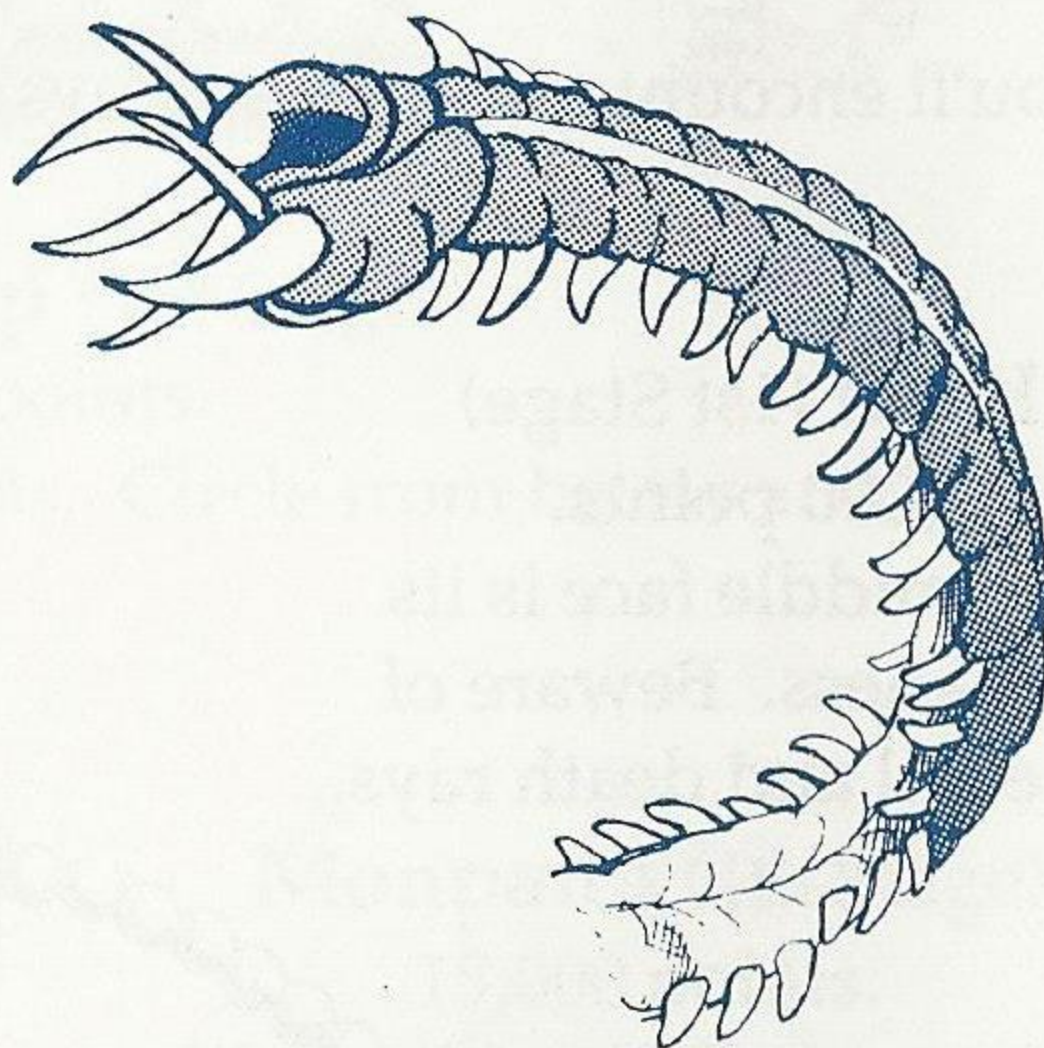

Mura

(head) 800 points.
(body) 300 points.
When hit on head, breaks
into pieces and scatters.

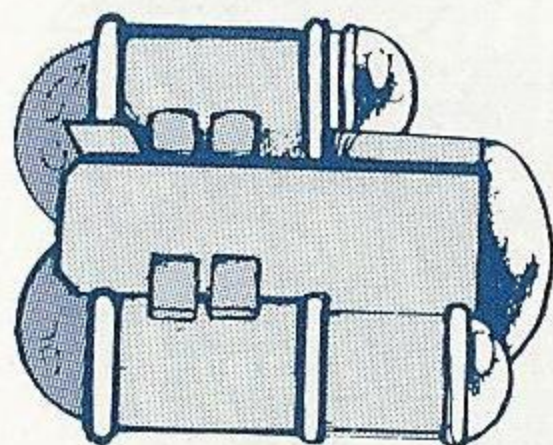

Dopu

1,000 points.
The pink window
is its weakness.

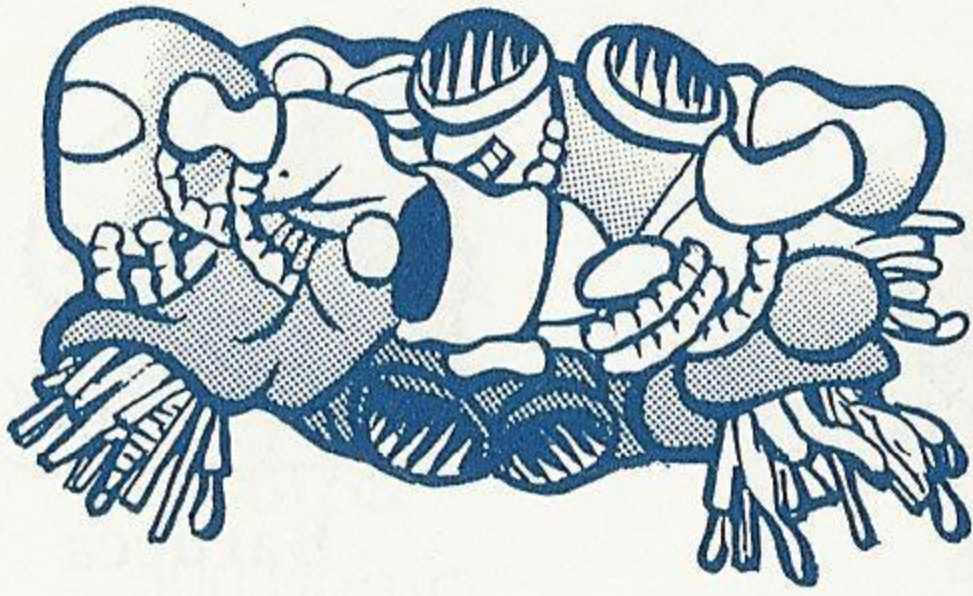

Borudo

1,500 points.

A moving obstacle that will not attack but is difficult to destroy.



Vin

Indestructible.

Moves from end to end of the screen. Watch its movement and avoid it.

Boss Aliens

You'll encounter these bad guys at the end of each round.

Krell (1st Stage)

5,000 points.

The middle face is its weakness. Beware of the tail and death rays.

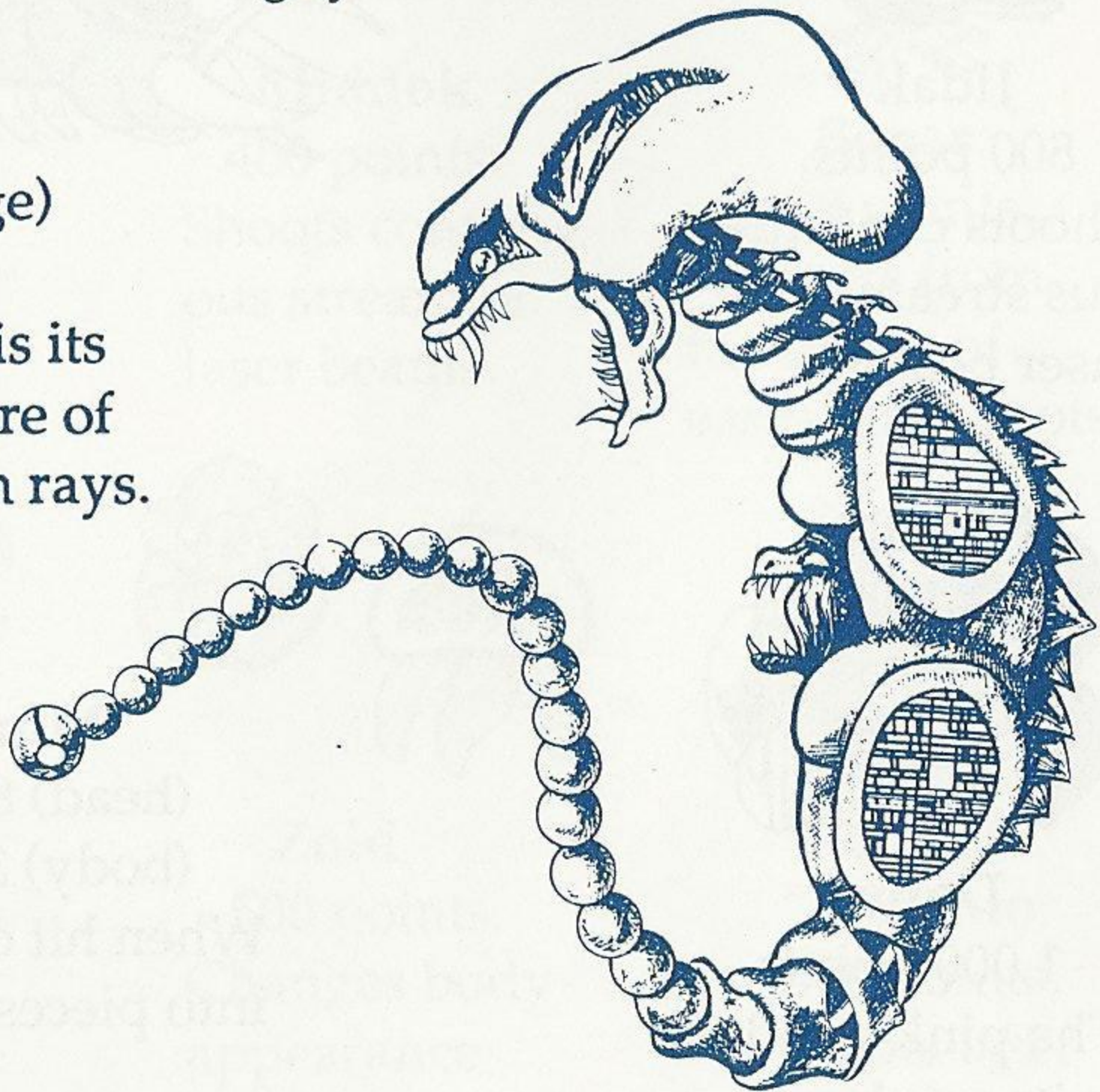



Gomanda (2nd Stage)

8,000 points.

Guarded by a death snake. Shoot it in the eye when it opens.

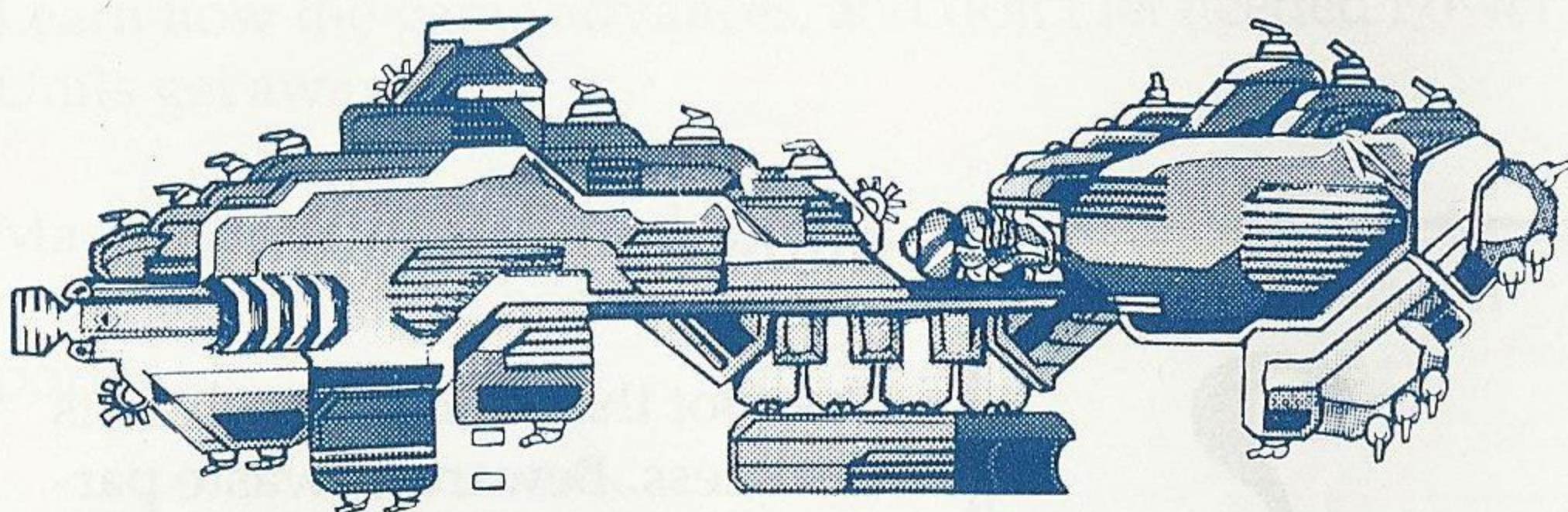

Mega Battleship (3rd Stage)

10,000 points.

Equipped with many cannons. Circle from below and blast the upper piston.

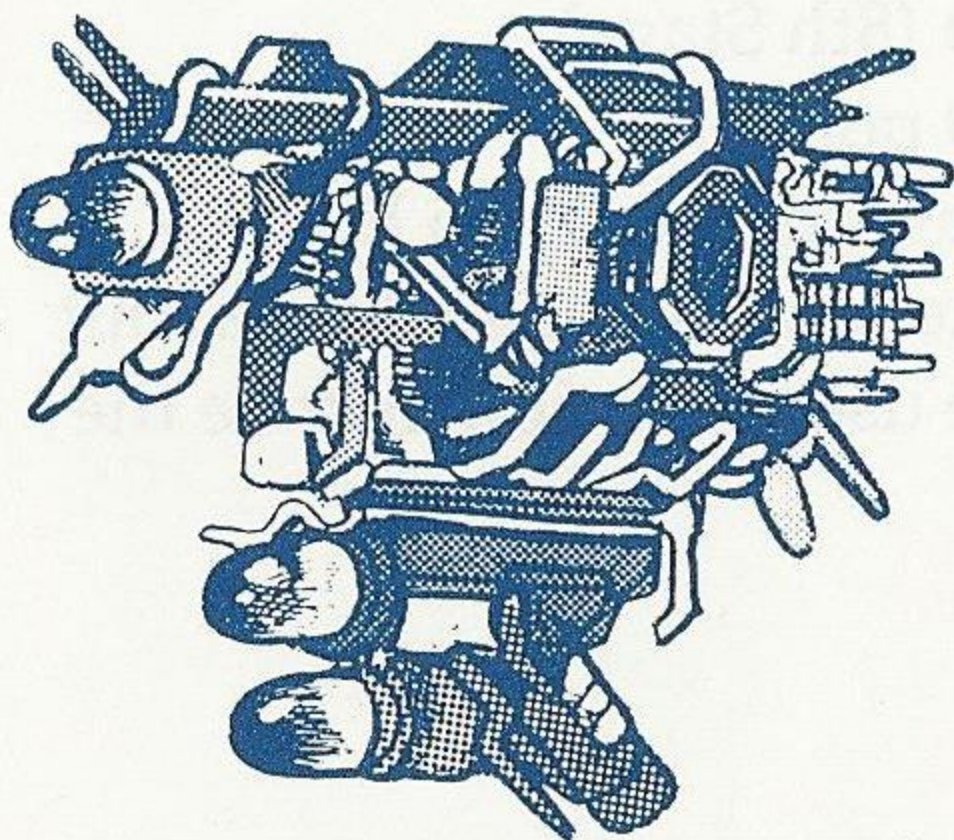

Monpaira (4th Stage)

15,000 points.

Many ships pulled together into one. Its weakness is when it separates. Watch the green windows.

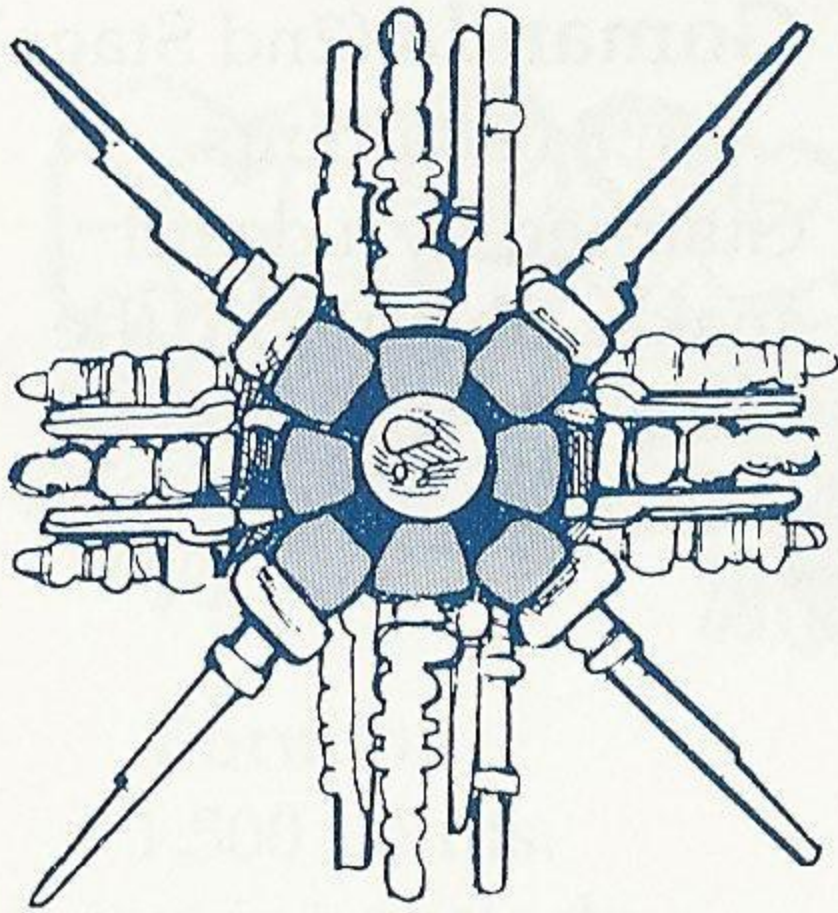

Kraken (5th Stage)

2,000 points.

Guarded by numerous octopi.
Center into the middle red
shiny spots and shoot.



Buronku (7th Stage)

0 points.

The spot that shines bluish is its
weakness. Beware of waste par-
ticles that fall from above.



Bydo (8th Stage)

15,000 points.

The ruler of the Bydo Empire.
No one knows its weakness, but
a wise use of Droids may be the
key.

NOTE: In the 6th stage, there is no Boss Alien.

Helpful Hints

Try running your fingers clockwise or counterclockwise around your D-Button. If it's during the right time and place, there's no telling what might happen!

Watch the demonstration screens carefully to get a good understanding of the attack hints.

Learn how the game advances, and don't let needed Power Units get away.

Master the separation and coming together of Droids. In order to defeat the bosses, clever use of Droids is very important.

✗

Handling The Mega Cartridge™

- The Mega Cartridge is intended exclusively for the Sega System™
- Do not bend, crush or submerge in liquids.
- Do not leave in direct sunlight or near a radiator or other source of heat.

90-Day Limited Warranty Sega® Card/Cartridge

To validate the following 90-day limited warranty, your sales slip or proof of purchase should be retained at time of purchase and presented at time of warranty claim.

90-Day Limited Warranty

Sega of America, Inc. warrants to the original consumer purchaser that this Sega Card™ / Cartridge™ shall be free from defects in material and workmanship for a period of 90 days from the date of purchase. If defect covered by this warranty occurs during this 90-day warranty period, Sega will repair or replace the defective card/cartridge, at its option, free of charge.

This warranty does not apply if the defects have been caused by negligence, accident, unreasonable use, modification, tampering or any other causes not related to defective materials or workmanship.

To receive fast, reliable service, call the Sega Customer Service Department at the following numbers:

Outside California: 800-USA-SEGA

Inside California: 415-742-9300

Our Customer Service Department is in operation from 9:00 AM to 5:00 PM (Pacific Time), Monday through Friday. *Do not return your Sega Card/Cartridge to your retail seller.*

Sega's service center is located at the following address:

Sega of America, Inc.

Warranty Repair

573 Forbes Blvd.

South San Francisco, CA 94080

Limitations On Warranty

Any applicable implied warranties, including warranties of merchantability and fitness for a particular purpose, are hereby limited to ninety days from the date of purchase and are subject to the conditions set forth herein. In no event shall Sega of America, Inc. be liable for consequential or incidental damages resulting from the breach of any express or implied warranties.

The provisions of this warranty are valid in the United States only. Some states do not allow limitations on how long an implied warranty lasts or exclusion of consequential or incidental damages, so the above limitations of exclusion may not apply to you. This warranty provides you with specific legal rights. You may have other rights which vary from state to state.

Sega Customer Service, 573 Forbes Blvd., South San Francisco, CA 94080

(800) U.S.A.-S.E.G.A.

Distributed by Tonka Corp.
Minnetonka, MN 55343

9002

SEGA[®]

F R O M T O N K A

R-TYPE ©1987 IREM Corp. Reprogrammed Game ©1988 Sega CONTROL PAD and CONTROL STICK are trademarks of Sega of America, Inc. SEGA is a trademark of Sega Enterprises, Ltd., a CSK Group Company.

PRINTED IN JAPAN

©1988 Tonka Corp. All Rights Reserved.