

# Golvellius™

## Valley of Doom

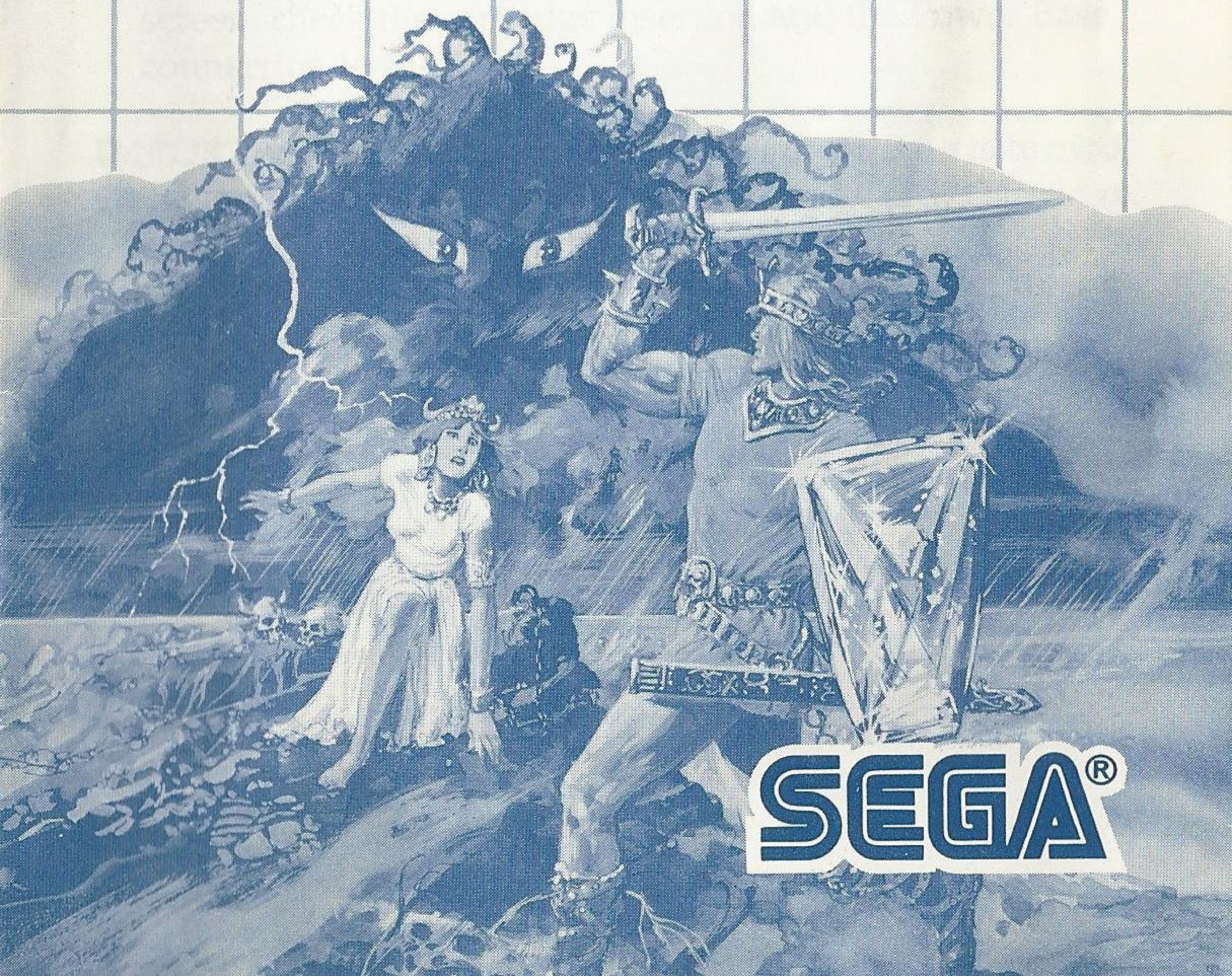

SEGA®

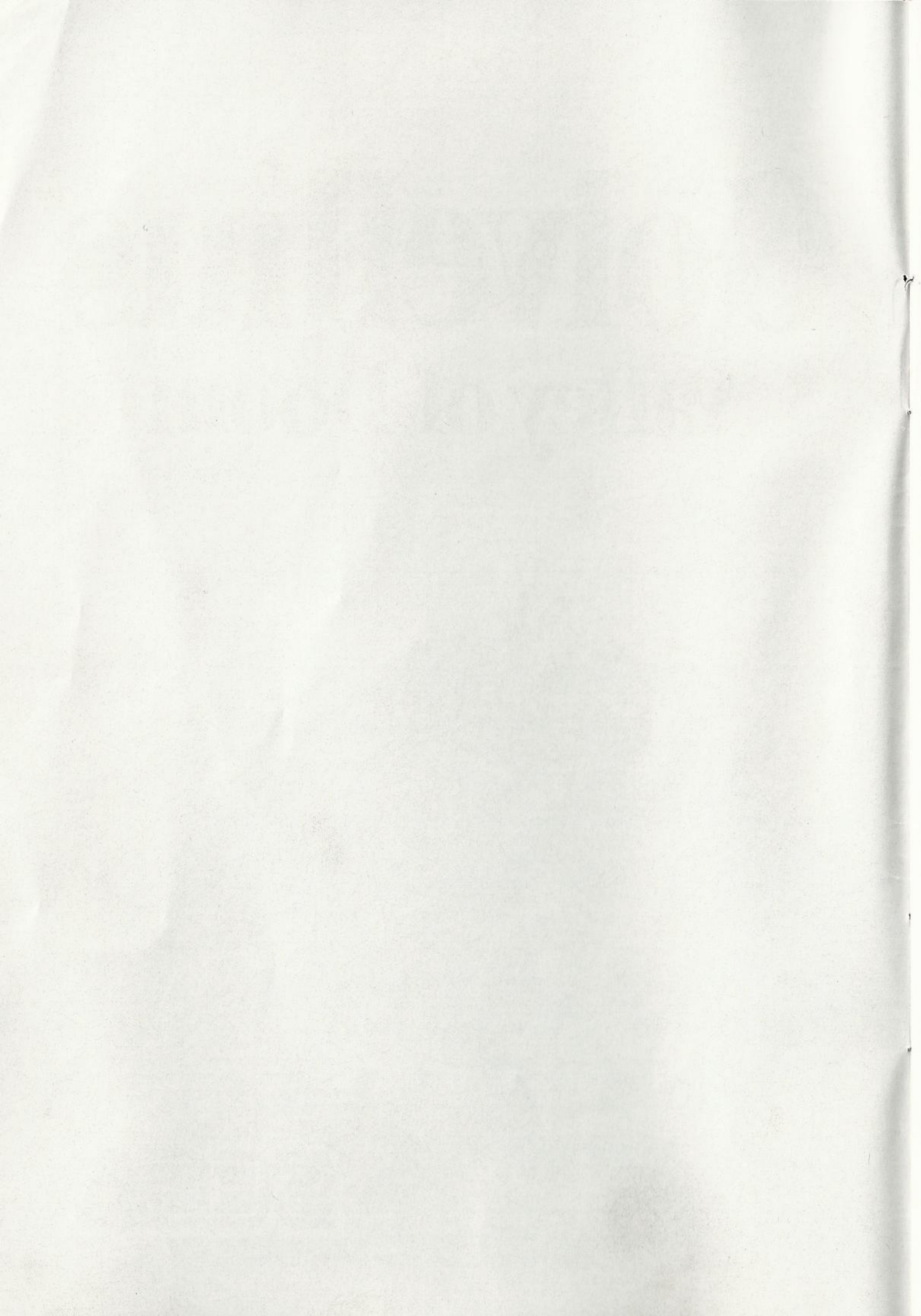

## Loading Instructions :

### Starting Up :

1. Make sure the power switch is OFF.
2. Insert Control Pad 1 into the "Control 1" input. Golvellius is a one player game.
3. Gently insert the Golvellius game cartridge into the Power Base. If the cartridge is properly aligned, it will easily slip into place.
4. Turn the power switch ON. If nothing appears on the screen, check the cartridge insertion and the Power Base connection to the TV.

**IMPORTANT :** Always make sure the Power Base is turned OFF when inserting or removing your Sega Card/Cartridge.

Insert Two-Mega Cartridge

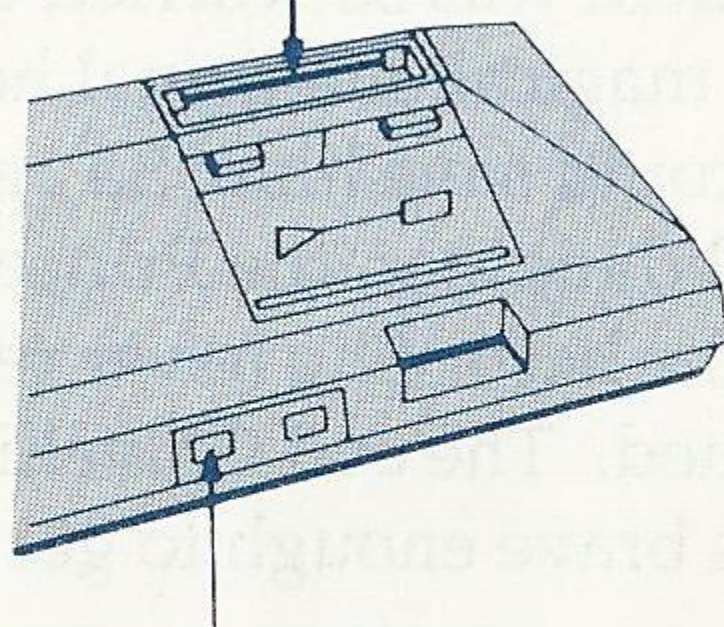

Insert Control Pad 1

## Valley of Doom!

Rex. In the language of kings, it means tyrant. It was a title used in legend to describe Golvellius, an evil king who had destroyed his kingdom and disappeared a thousand years ago.

Under new kings, the country was reborn and knew decades of peace and prosperity. In time, the kingdom became known as Aleid after the current ruler, the good King Aleid. The kingdom only had one problem. For water, the people had to go to the river valley. But the people of Aleid were honest and hard-working, so they didn't mind the walk. Until demons began to appear in the valley!

The tales of demons continued to grow. And when people who went to the valley for water failed to return, the feared name Golvellius...once used just to scare bad children...was whispered from stall to stall in the marketplace. And the valley of life now became called "The Valley of Doom."

The good King Aleid was so worried that he fell sick with remorse. Only a magical, medicinal herb called Mea, found on the valley floor, could save him. So against all objections, his good and faithful daughter, the Princess Rena, journeyed to the valley to obtain the herb. She never returned. The people knew what had happened. The evil Golvellius has captured her! And nobody was brave enough to get her back!

Then, a wandering lad with wild green hair and a taste for adventure came into the village. His name was Kelesis, which in the language of the kingdom of Aleid meant, "Bane of Demons."

Kelesis listened to the story of the missing Princess. He listened to the terrible legends of Golvellius. Then he looked at a picture of Princess Rena and fell in love.

After that, there was no stopping him. He said, "I'm going into the valley for Rena. Any who tries to stop me...shall feel the bite of my sword!"

Kelesis entered the cave leading to the Valley of Doom. And thus began his quest...

## The Object of Golvellius

The evil Golvellius has kidnapped the Princess Rena. As Kelesis, you must get her back! He has hidden her somewhere in the valley. But beware...the valley is long and wide...and filled with surprises.

Golvellius has sent seven of his fiercest demons to stop you. Before you do battle with Golvellius, you must defeat his demons. You will find them in caves hidden throughout the valley floor. Some caves can be opened by defeating some of the wild beasts of the valley. Some will appear when certain objects are struck with your sword.

But despair not! For in some caves you will find fairies, sorceresses and wise women who will help you in many ways. If you die in the course of your quest, write down the Password that appears. By entering this Password, you will be able to begin the game from the opening of the valley (if you get that far) with all your possessions intact.

Now get in there and save the Princess! Can't you hear her calling for help?

# Taking Control

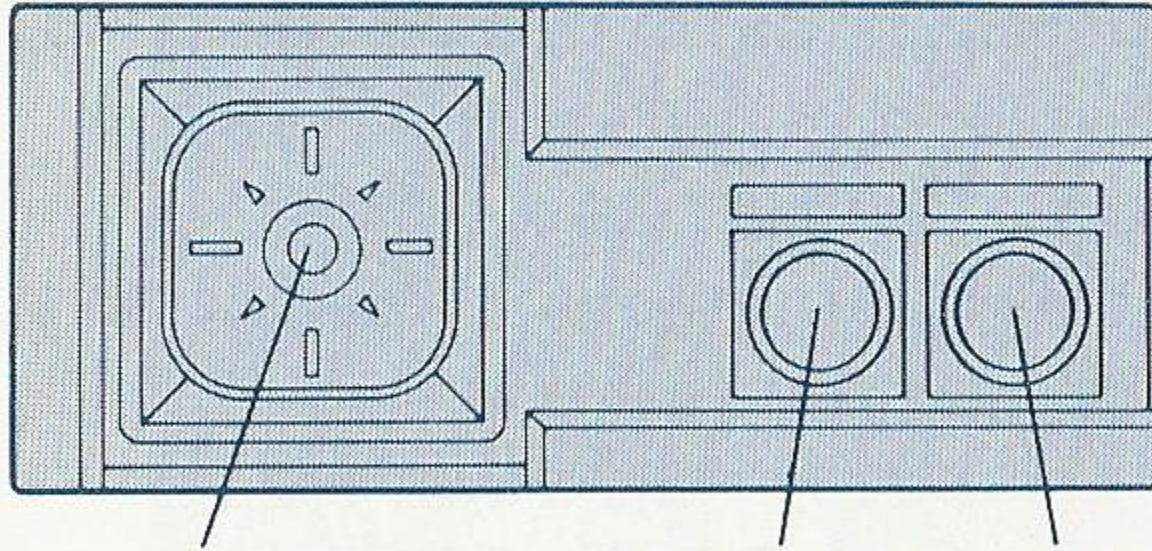

DIRECTIONAL BUTTON  
BUTTON ①      BUTTON ②  
(D-Button)

## Directional Button (D-Button):

*Horizontal Mode* : Moves player in eight directions; UP, DOWN, LEFT, RIGHT and DIAGONALLY.

*Vertical Mode* : Moves player UP, DOWN, LEFT and RIGHT.

## Button 1 :

*Horizontal Mode* : Press to use sword.

*Vertical Mode* : Press to use sword.

## Button 2 :

*Horizontal Mode* : Press to jump.

*Vertical Mode* : Press to use sword.

## Starting the Game

Insert the Golvellius cartridge into your Power Base and press the Power Button. When the title screen appears, you can either;

1. Wait for the demonstration mode to begin so you can see the Golvellius story, or:
2. Press the Start Button to begin a game.

If you are beginning a new game, select NEW GAME using the D-Button and press Button 1 or Button 2.

If you are continuing a game, select CONTINUE. You can then choose LAST GAME CONTINUE, which lets you continue the game you just played.

If you have turned OFF the power and have restarted the system, choose PASSWORD CONTINUE, which lets you use your Password to continue the game you were playing before the power was turned OFF.



## Using The Password Feature



You receive a Password when the game you are playing is ended. The Password allows you to continue the game at a later time with all the possessions you have found and half of your gold.

Use the D-Button to select the numbers and letters. Press Button 1 to register the number or letter. When the last number or letter is entered, the game will begin at the mouth of the valley.

If you have entered an incorrect Password, the message "WRONG PASSWORD" will appear. Check your Password and enter the numbers again.

# Playing Golvellius

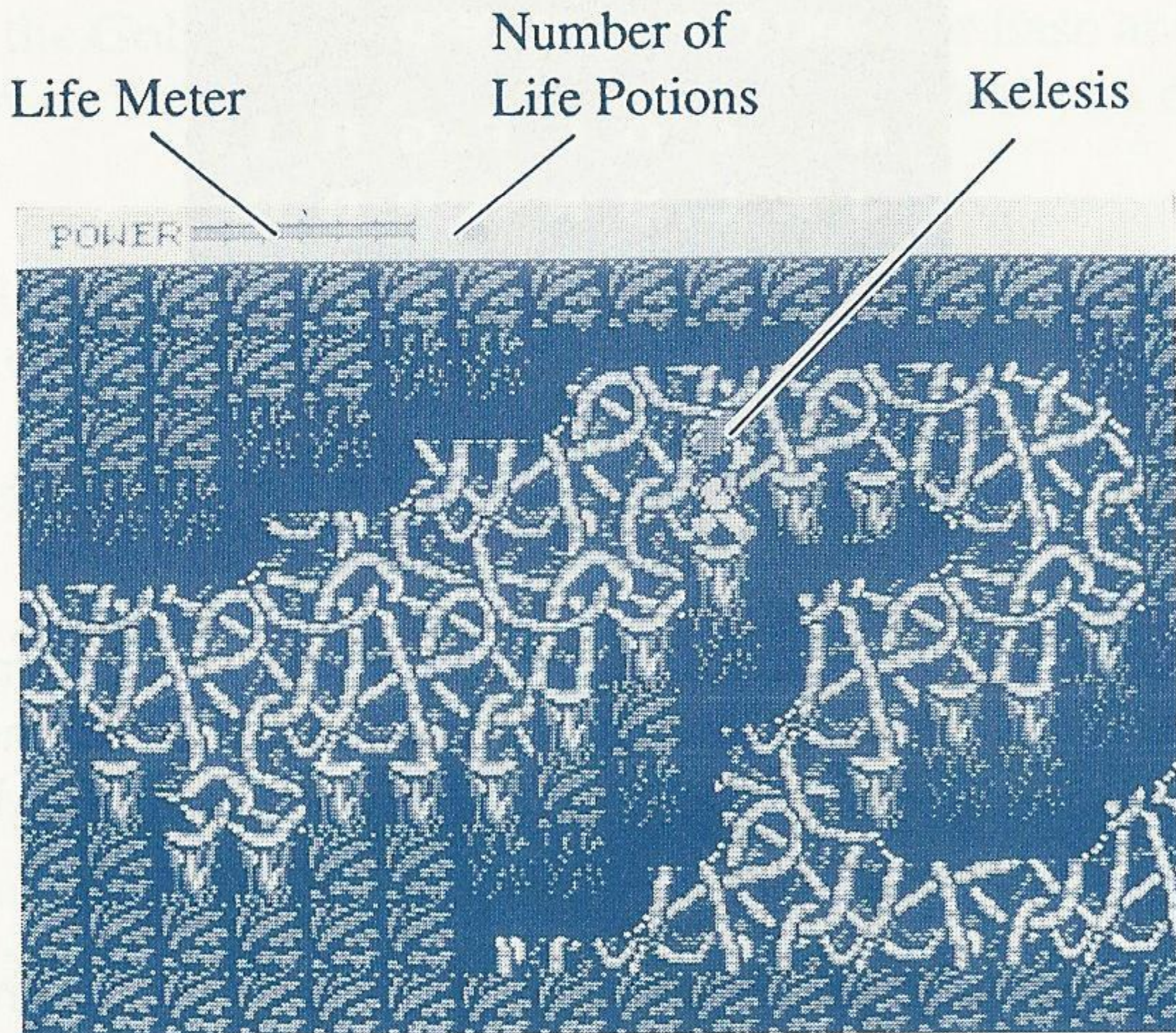

You begin Golvellius with a full Life Meter and one extra Life Potion. You will be able to purchase additional Life Potions from certain people in the course of the game.

Each successful attack from the enemies will deplete a portion of your Life Meter. When your Life Meter has turned white and you have no more Life Potions, you expire and the game is over.

# Horizontal and Vertical Play Modes

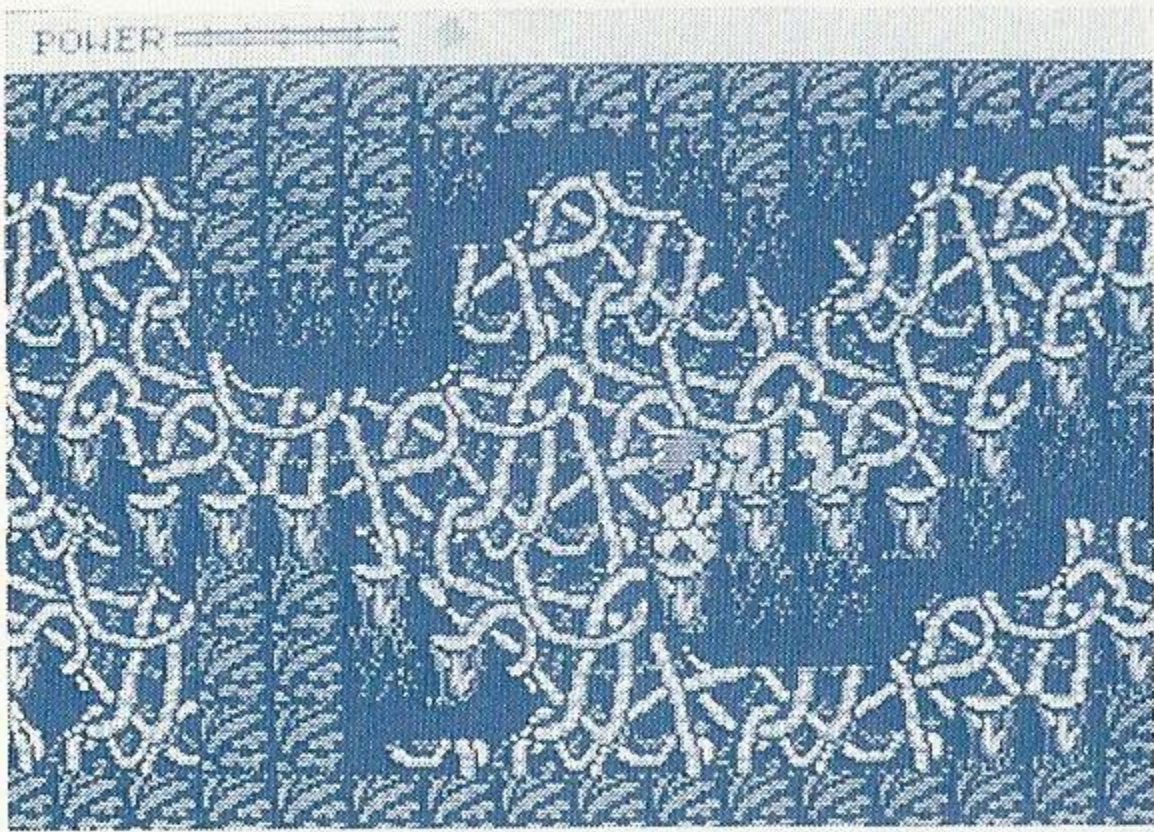

Golvellius takes place above and below ground. The game begins in the Horizontal mode, where you must take Kelesis through a danger filled tunnel!

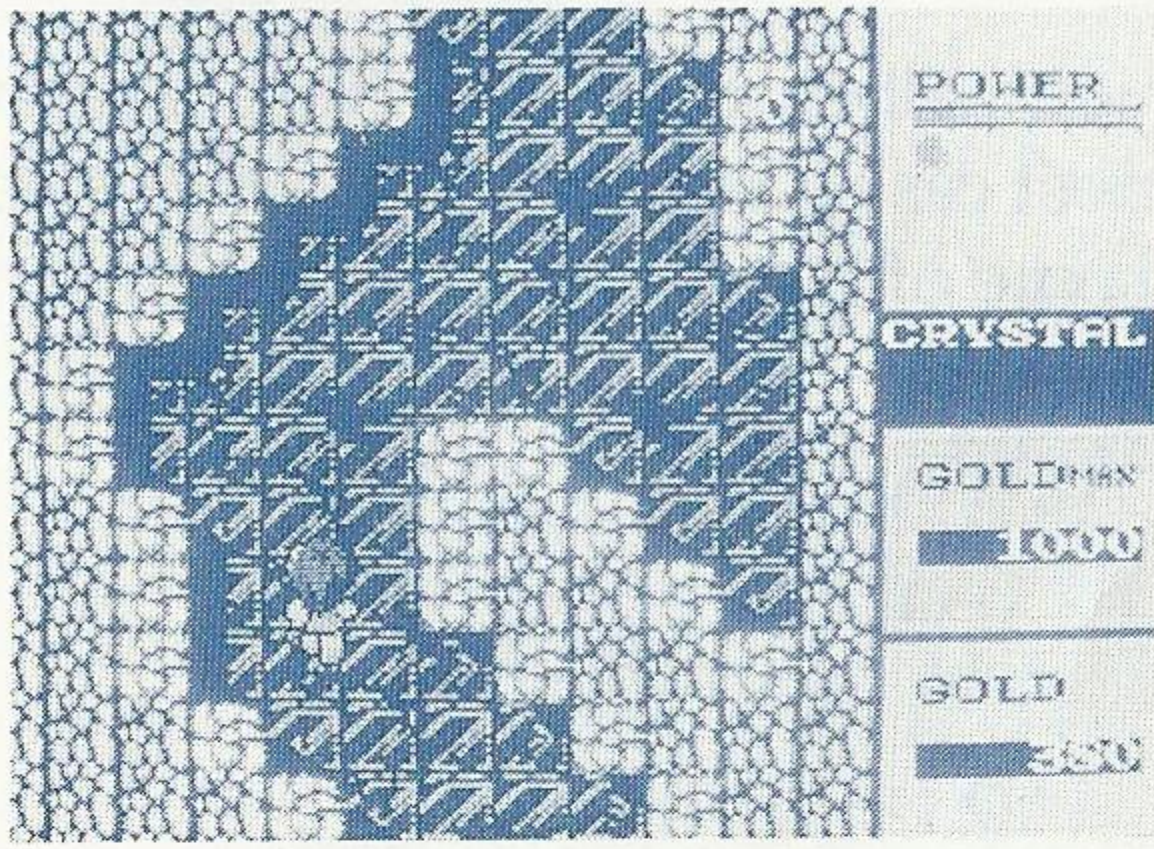

When travelling above ground in the valley, the game play will be in the Vertical mode. Either Button 1 or Button 2 will operate the sword.

## Inventory Screen

When you enter the valley, pressing the PAUSE button will access the Inventory Screen. This lets you keep track of how much gold you own, how much gold you can have in your possession, how many Life Potions you own and what special items you have acquired.

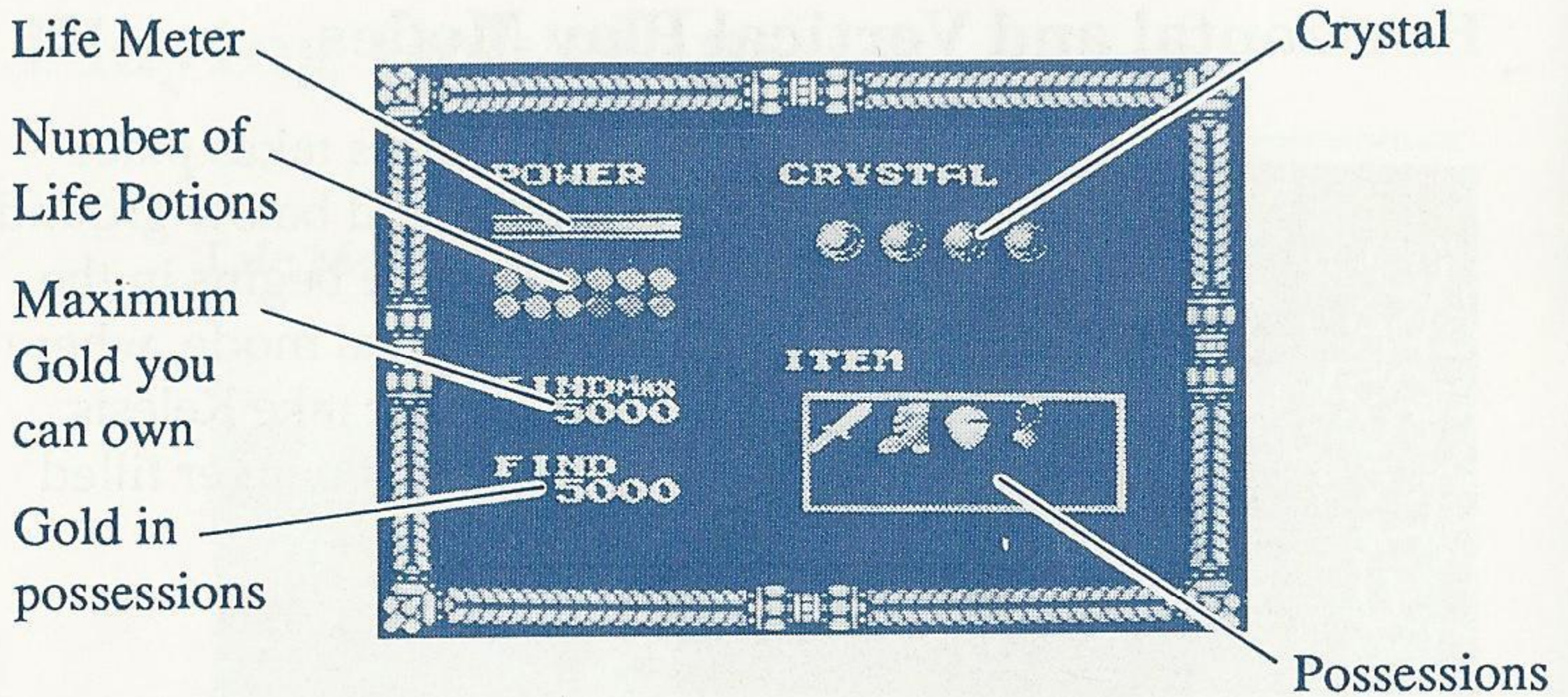

## Caves

All the people and demons you will encounter in the valley live in caves below ground. In most cases these caves are concealed and you will have to defeat some of the enemies on screen for the entrance to be revealed.

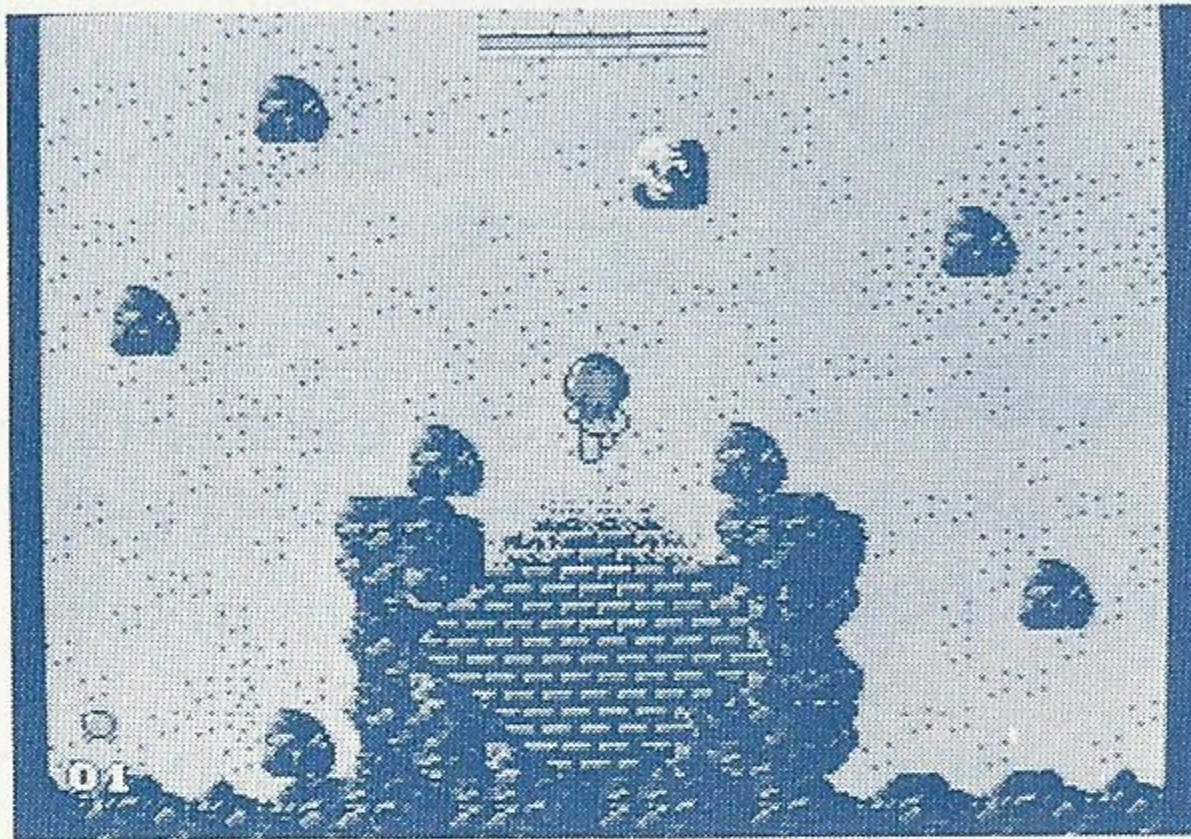

As you get further into the game, some caves can only be opened by striking certain objects with a magical sword...if you have a special object! **REMEMBER:** Caves will often appear where you least expect them to be.

# Know Thy Friends

Here are the friendly folk you will meet in the course of the game. They will all turn up from time to time and each has something special to offer.



**Wise Woman**

The Wise Woman will have special items that you need to complete the game! They are kind, despite their sharp wit. But remember that you will have to pay for many of their items!



**Rio**

Rio is full of interesting hints and occasional bits of humor. She loves snow cones!



**Annie**

If your Life Meter is running low, Annie will restore it for a price.

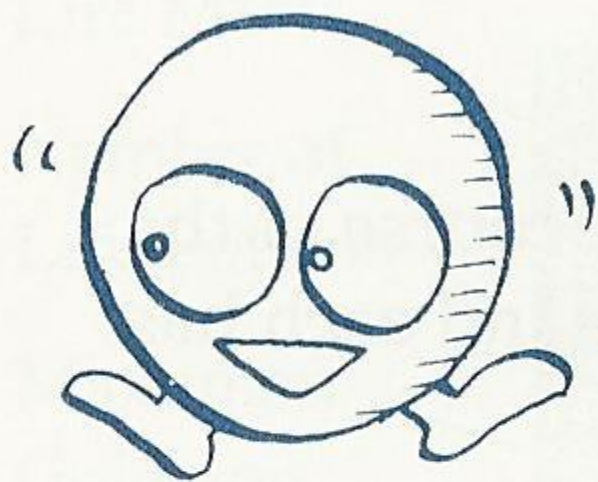

Randar

For the minor sum of 150 pieces of gold, Randar will restore your Life Meter and all your Life Potions. What a deal! When you are in need, Randar is a good friend indeed.



Dina

For some of your Life Potion, Dina will give you gold. It really doesn't hurt so bad when she puts the bite on you!



Winkle

Winkle has the ability to see into the future and give you a Password. When she does, write it down and use it to get back into the game if you die!

## Special Items

Special Items can be found or purchased throughout the game. You will need them to defeat Golvellius and his evil minions!

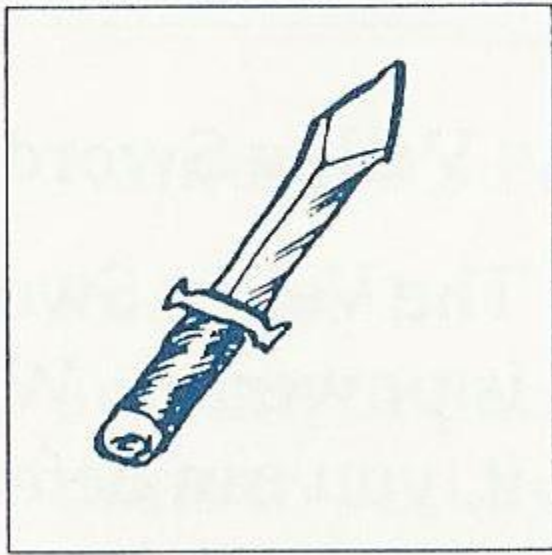

Long Sword

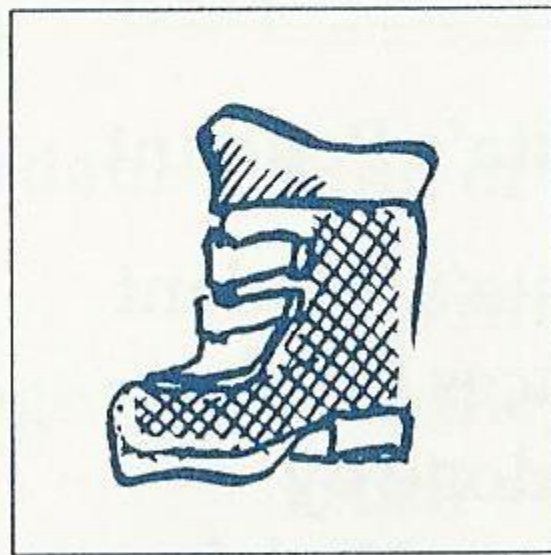

Zest Boots

A Wise Woman will give these to you when you enter the cave to the valley. Zest Boots allows you to quickly regain your footing after an enemy attack.

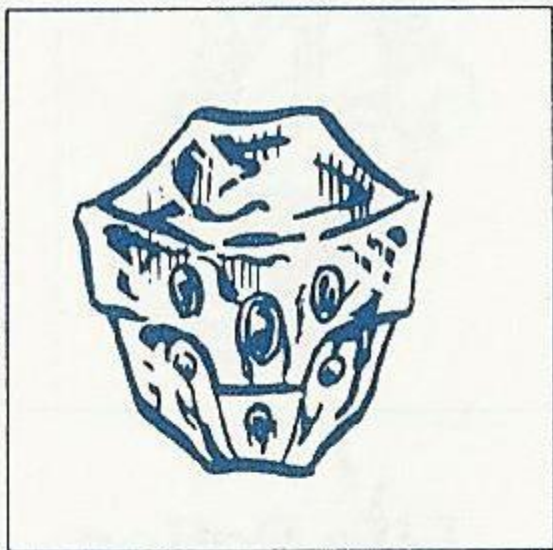

Remedia's Shield

Will deflect the missiles of all creatures except Golvellius' demons.

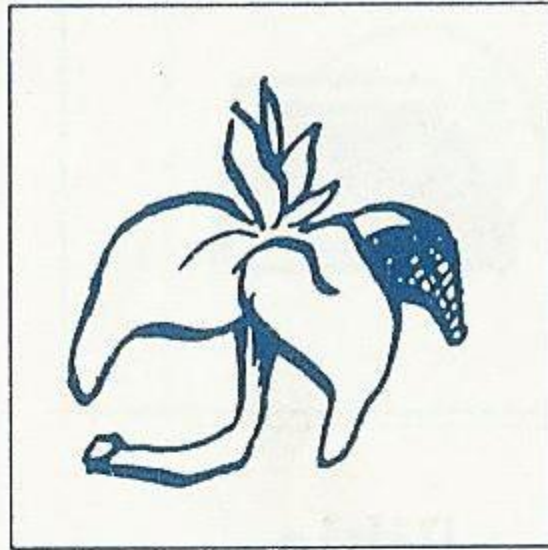

Mea(green)

Mea is a magical herb that will restore life. This was the herb Rena went looking for. There are two kinds. The green will restore one-quarter of your life. The purple Mea will restore one-half of your life.

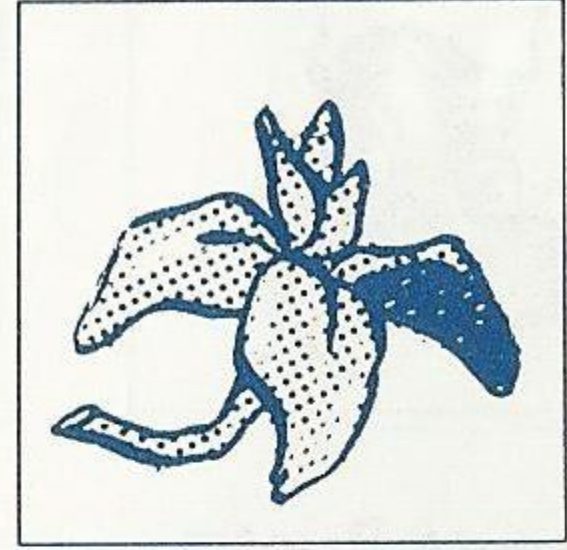

Mea(purple)

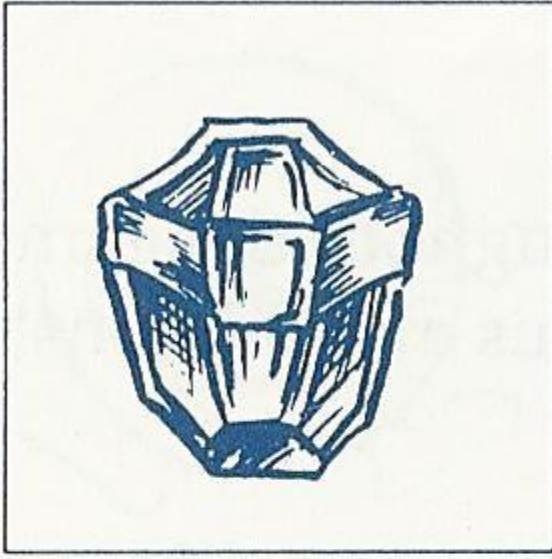

### Aruzasu's Shield

This shield will deflect the bullets fired by bees and spiders.

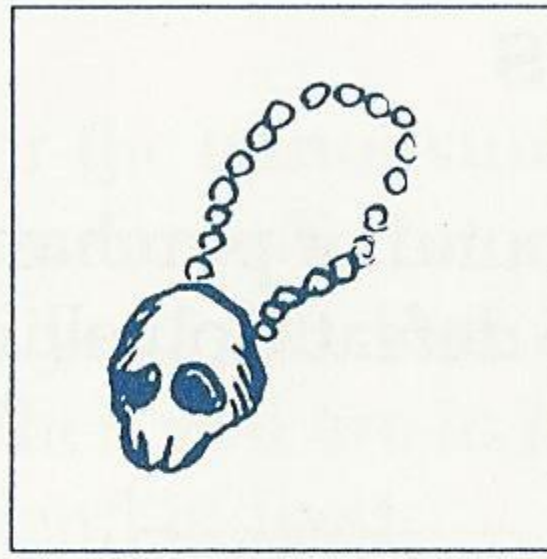

### Aresta's Pendant

Aresta's Pendant reduces the damage done by enemy attack by one - quarter.



### Valley Sword

The Valley Sword is powerful. With it, you can defeat your enemies much faster.



### Aqua Boots

Aqua Boots will let you walk on water. They will greatly aid your travels.

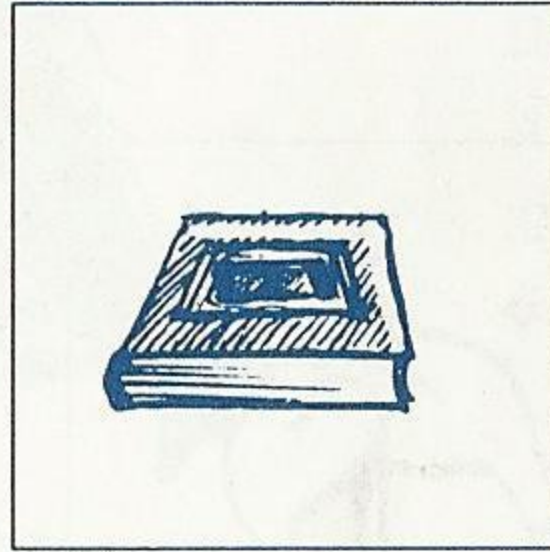

### Bible

A Bible increases the amount of gold you may own. You need Bibles, because some items in the game are very expensive!



### Life Potion

Buy every Life Potion you can. Golvellius and his demons are very strong...and can do much damage when they strike you!



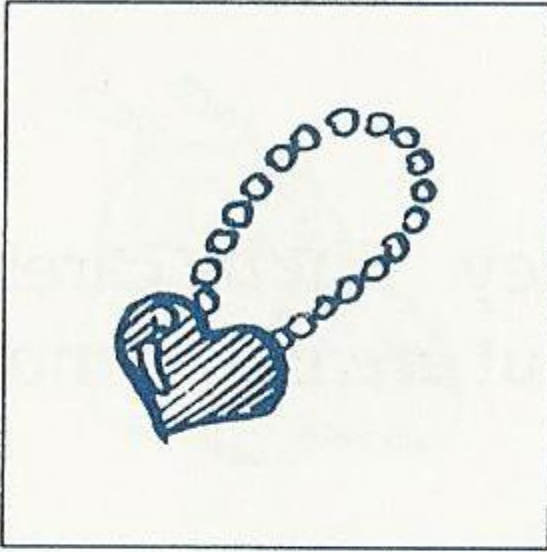

### Ramurasu's Pendant

Reduces the amount of damage done to you by one-half.

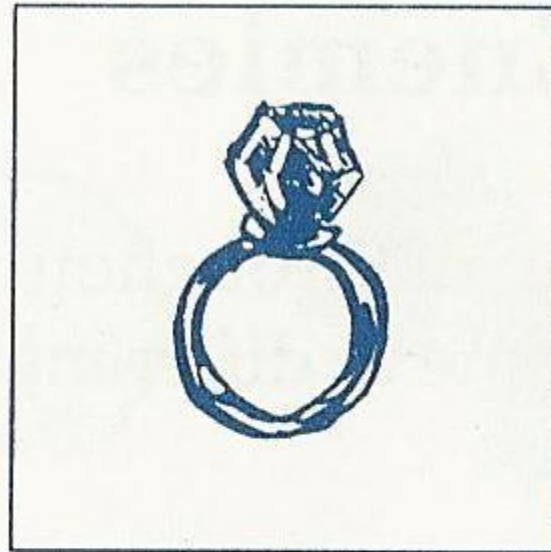

### Ring of Invincibility

This ring gives you the power to crush stone with your sword.

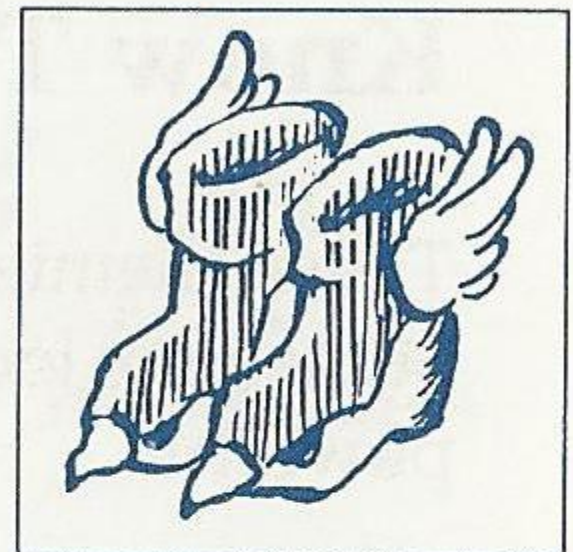

### Ascent Boots

Ascent Boots let you walk on land, over water, trees and rocks!

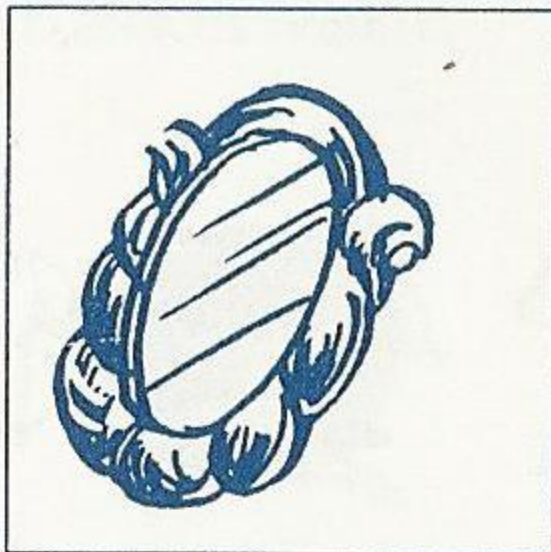

### Mirror

The magic Mirror will make invisible enemies appear before your eyes.

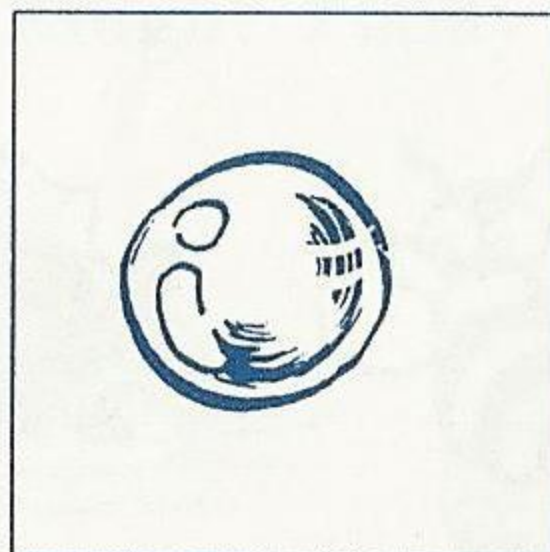

### Crystal

The seven Crystals hold the key to Golvellius' power. You will find them after you have defeated certain demons.

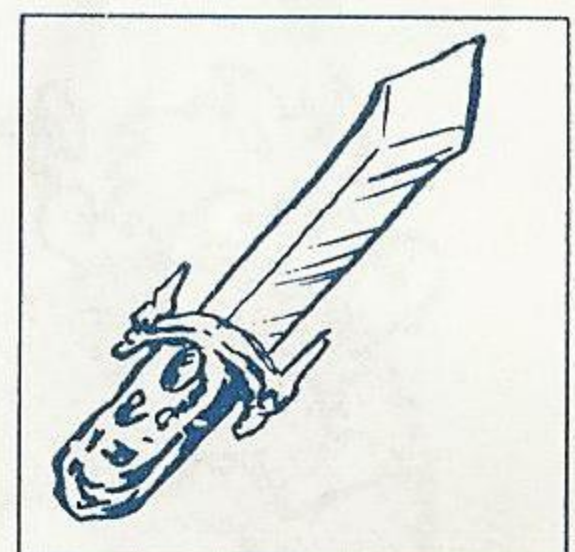

### Legendary Sword

The Legendary Sword was once carried in battle by a great warrior. Its powers may astound you; if you can set it free!

# Know Thy Enemies

These enemies appear all throughout the valley. But be careful. Some may look the same in different colors but are much more powerful!



Snake

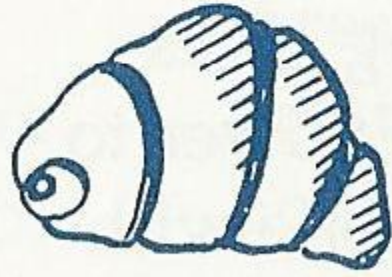

Potato Bug



Bat



Spider



Troll



Bee



Porcupig



Water Spirit

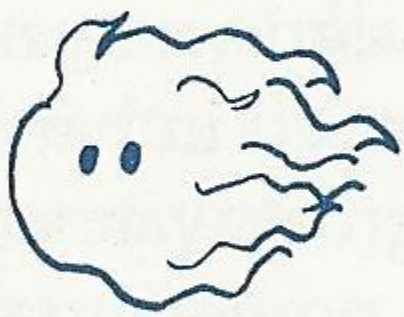

Fire Spirit

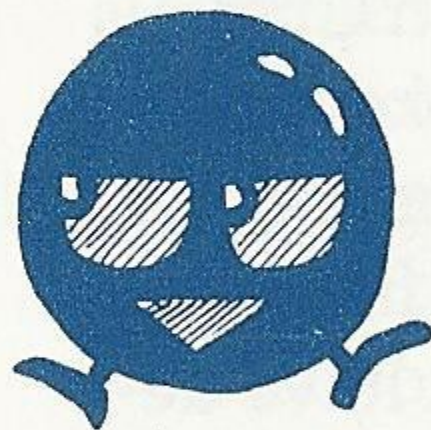

Koranda



Fly



Vortex



Jellyfish



Frog



Crow



Mole



Basketworm



Stone Knight



Pigmy Skeleton



Death Lord



Tick

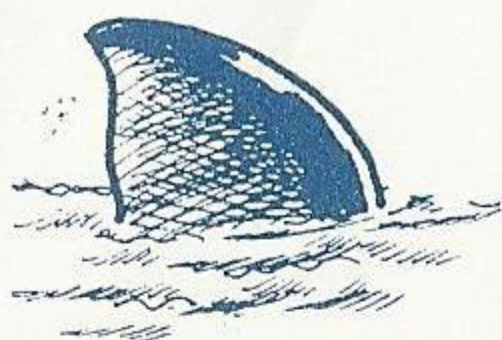

Shark Fin



Snakelet

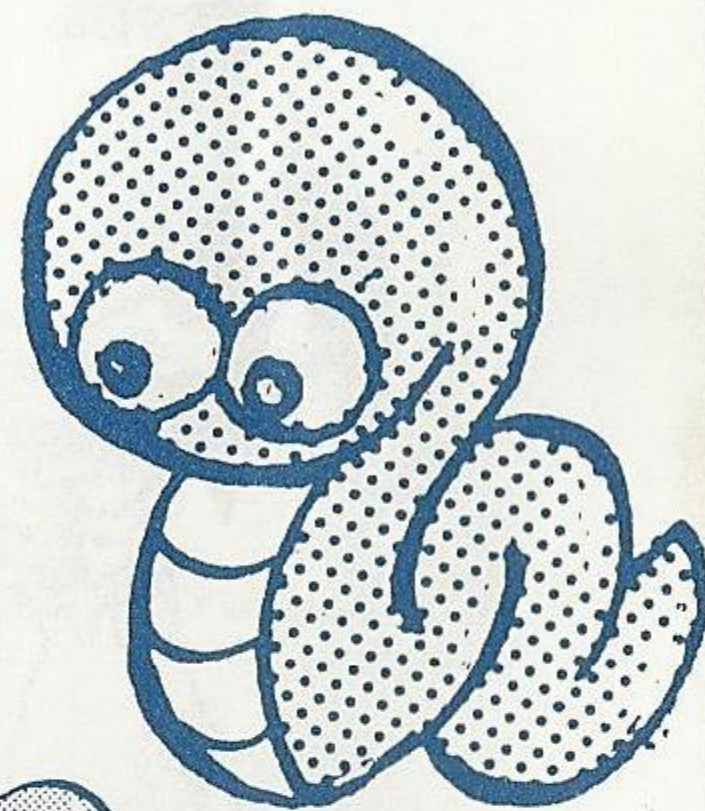

Giant Snake



Flea



Rat



Snakelet



Snakelet

## The Demons

These are the minions of Golvellius. Each is strong and fierce. Only by defeating them will you be able to get the seven Crystals from the Wise Women.



Desba



Saipa



Taruba



Fosbus



Waruso

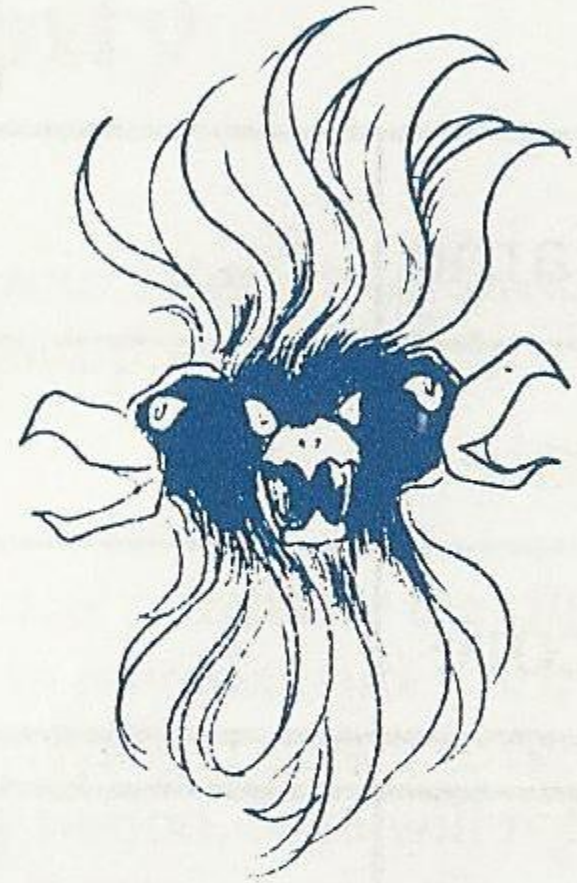

Jasba



Heidi



Golvellius...?

## Helpful Hints

Write down your Passwords! They will make returning to the game after the power has been shut OFF much easier.

# Scorebook

Name				
Date				
Score				

Name				
Date				
Score				

Name				
Date				
Score				

## Handling The Mega Cartridge™

- The Mega Cartridge is intended exclusively for the Sega System™.
- Do not bend, crush or submerge in liquids.
- Do not leave in direct sunlight or near a radiator or other source of heat.

# 90-Day Limited Warranty Sega® Card/Cartridge

To validate the following 90-day limited warranty, your sales slip or proof of purchase should be retained at time of purchase and presented at time of warranty claim.

## 90-Day Limited Warranty

Sega of America, Inc. warrants to the original consumer purchaser that this Sega Card™ /Cartridge™ shall be free from defects in material and workmanship for a period of 90 days from the date of purchase. If defect covered by this warranty occurs during this 90-day warranty period, Sega will repair or replace the defective card/cartridge, at its option, free of charge.

This warranty does not apply if the defects have been caused by negligence, accident, unreasonable use, modification, tampering or any other causes not related to defective materials or workmanship.

To receive fast, reliable service, call the Sega Customer Service Department at the following numbers:

Outside California: 800-USA-SEGA

Inside California: 415-742-9300

Our Customer Service Department is in operation from 9:00 AM to 5:00 PM (Pacific Time), Monday through Friday. *Do not return your Sega Card/Cartridge to your retail seller.*

Sega's service center is located at the following address:

Sega of America, Inc.

Warranty Repair

573 Forbes Blvd.

South San Francisco, CA 94080

## Limitations On Warranty

Any applicable implied warranties, including warranties of merchantability and fitness for a particular purpose, are hereby limited to ninety days from the date of purchase and are subject to the conditions set forth herein. In no event shall Sega of America, Inc. be liable for consequential or incidental damages resulting from the breach of any express or implied warranties.

The provisions of this warranty are valid in the United States only. Some states do not allow limitations on how long an implied warranty lasts or exclusion of consequential or incidental damages, so the above limitations of exclusion may not apply to you. This warranty provides you with specific legal rights. You may have other rights which vary from state to state.

Sega Customer Service, 573 Forbes Blvd., South San Francisco, CA 94080

(800) U.S.A.-S.E.G.A.

Distributed by Tonka Corp.  
Minnetonka, MN 55343

7017

**SEGA**<sup>®</sup>

F R O M T O N K A

**CONTROL PAD & CONTROL STICK** are trademarks of Sega Of America, Inc.  
**SEGA** is a trademark of Sega Enterprises, Ltd., a CSK Group Company.

PRINTED IN JAPAN

© 1988 Tonka Corp. All Rights Reserved.