

SEGA SCOPE™
3-D

Maze Hunter™ 3-D

You're trapped in a twenty level, creature filled maze. To survive, you must fight your way to the bottom!

The odds are against you. But you have a few tricks up your sleeve . . .



SEGA®

Loading Instructions: Starting Up

Maze Hunter™ 3-D is designed for use with the SegaScope™ 3-D Glasses™ and Sega Control Pad or optional Control Stick.

It's one of a new generation of games which give you the ultimate dimension in 3-D video game play, SegaScope™ 3-D! Follow these set up instructions, and watch your screen come alive!

The following instructions are for game set up:

1. Make sure the power switch is OFF.
2. Insert the 3-D Adaptor Unit into the Power Base card slot. Insert the 3-D Glasses plug into the 3-D Adaptor Unit's jack port.
3. Gently insert the Maze Hunter 3-D cartridge into the Power Base. If the cartridge is properly aligned, it will slip into place without strong force.
4. Turn the power switch ON. If nothing appears on the screen, check the cartridge insertion and Power Base connection to the TV.
5. Plug the Control Pad or Control Stick into the "Control 1" input on the Power Base.
6. Put the 3-D Glasses on. If there is no 3-D effect, check the connection to the 3-D Glasses, and check that the 3-D Adaptor Unit is properly installed.
7. Push Button #1 to start. If nothing happens, check the connection between the Control Pad or Control Stick and the Power Base. Also make sure you are using the left control port, "Control 1".

IMPORTANT: Always make sure that the Power Base is turned OFF when inserting or removing your Sega Card/Cartridge.[™]

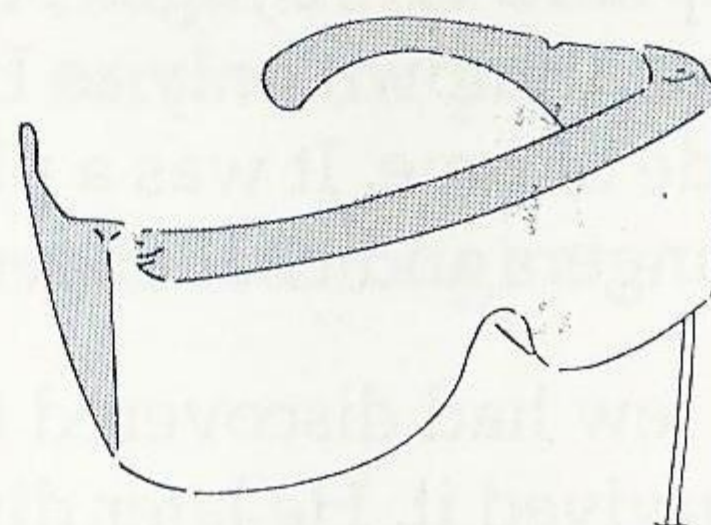
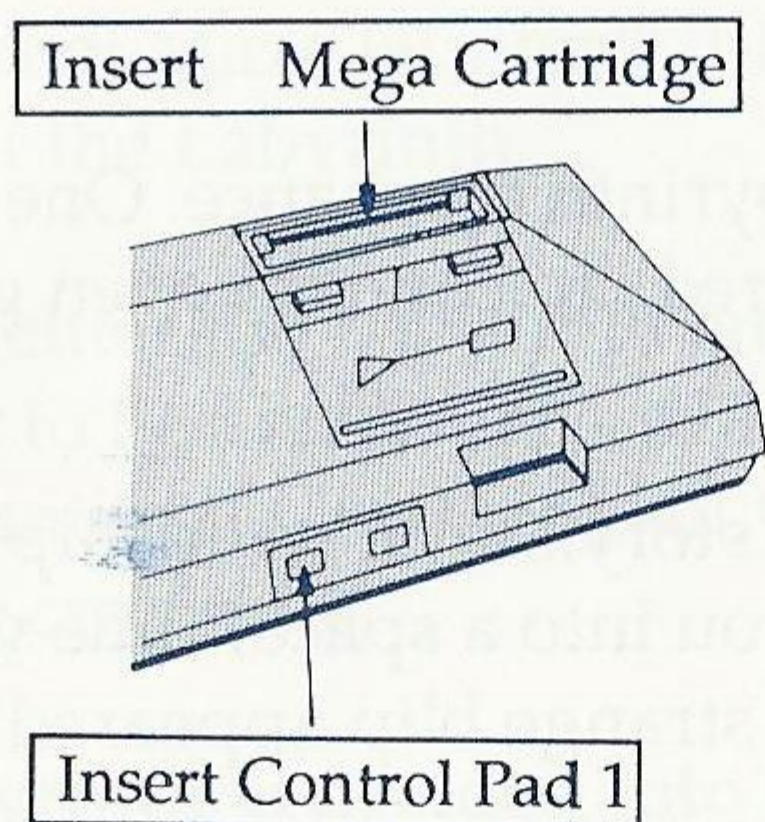

3-D Adaptor

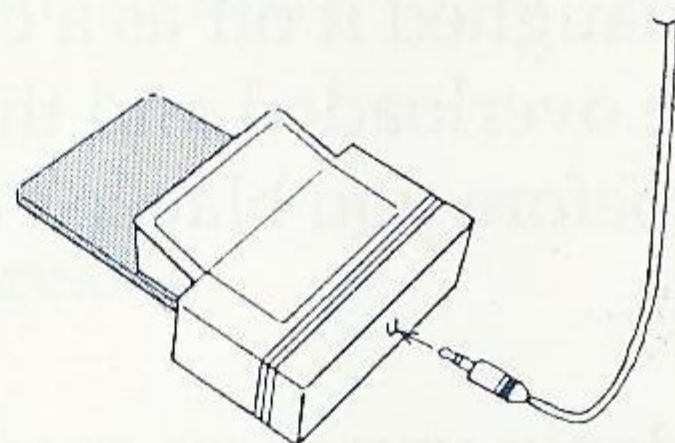

SegaScope[™] 3-D

SegaScope[™] 3-D adds challenging dimensions to your game play. It's 3-D like you've never seen before! Here's why.

We see in three dimensions because each eye sees a slightly different picture. The Maze Hunter[™] 3-D game cartridge displays both of these images. That's why when you look at the screen without the glasses, the image looks blurred.

But when you put on the SegaScope 3-D Glasses,[™] the liquid crystal shutters in each eye shield "flash" so that each eye sees only one image.

The result: 3-D games so real that you become a part of the action. SegaScope[™] 3-D takes you there!

The Legend of The Maze Hunter

For centuries it had been a legend...a story told by space captains on voyages between the stars. A mysterious death maze, known only as Labyrinth, that existed in an area outside of time. It was a place said to be filled with unknown dangers and challenges.

A few had discovered the Labyrinth by chance. One had survived it. He later disappeared...to conquer even greater challenges.

You laughed it off as a child's story...until your ship's fusion drive overloaded and threw you into a space/time warp. Just before you blacked out, a strange blip appeared on the radar...

Suddenly you were awake. On the wall in front of you were scratched the names of those who had come before. You had found the labyrinth!

A corridor stretched out in front of you. It echoed with the chilling screams of unknown beasts. Above was the star-filled void of space. There was only one way to go...down...into the labyrinth!

A burning smell filled the air. All around you the ground began to tremble as strange creatures materialized into existence! Soon you would learn their names. But for now all you could do was run down the corridor, searching for a weapon.

A single thought kept you going. The legend said one had survived the Labyrinth. He had been called the Maze Hunter!

Surviving the Labyrinth

Welcome, Maze Hunter, to the labyrinth. Your journey will take you through dangers beyond your imagination! This section will give you clues necessary to survive the perils.

The object of Maze Hunter™ 3-D is to make it through the bottom of the Labyrinth.

You will enter the Labyrinth empty-handed. There are weapons to be found, each which will give you extra powers. But until you get them, all you can do is try to jump over the maze creatures.

The Labyrinth is divided into five areas:

1. Metal Area
2. Rugged Area
3. Jungle Area
4. Ice Area
5. Blaze Area

Each Area has 4 Levels. And each Level has 3 sublevels. Warp Tunnels will take you from one sublevel to the next. To go on to the next Level or Area, you need to find a Gate Key. This...and only this...will unlock the warp gate so you can continue with the game.

Taking Control

The following illustration shows you the control points on your SEGA SYSTEM Control Pad. Throughout this instruction manual, we will refer to these controls by the names indicated here.

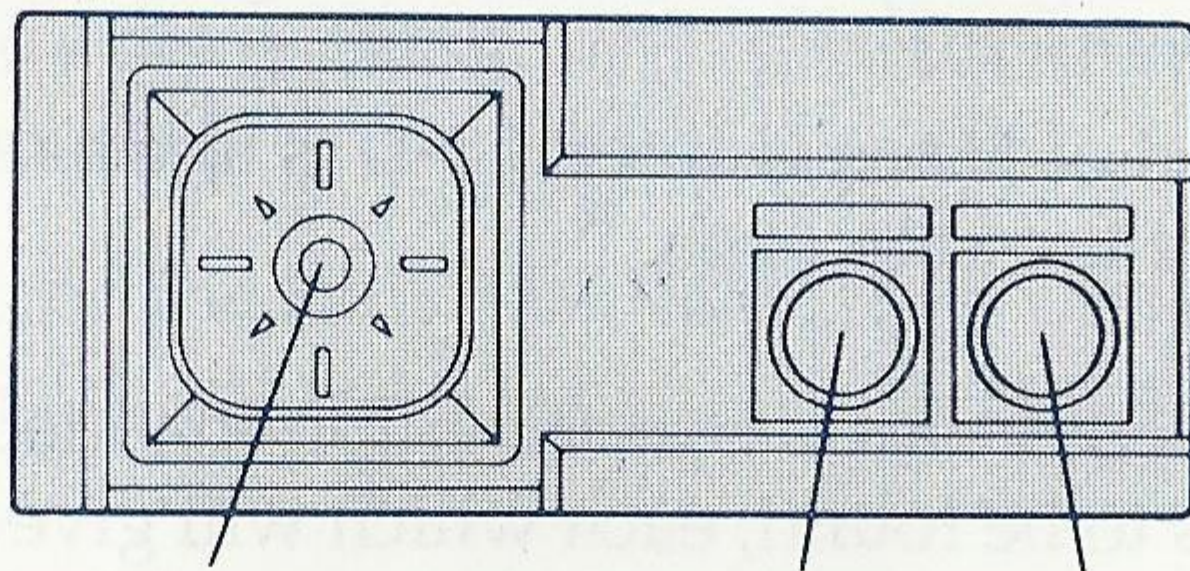

DIRECTION
BUTTON
(D-BUTTON)

BUTTON BUTTON
① ②

D-Button:

- Moves character in 8 directions.

Button #1:

- To start the game.
- Use for striking with the iron bar.
- For using any weapon found in the maze.

Button #2:

- Press to jump.

How to View the Screen

When you press Button #1 to start the game, you will see a screen showing your score, the Area and Level you are in, and what items you currently have. You then enter the game and see this screen:

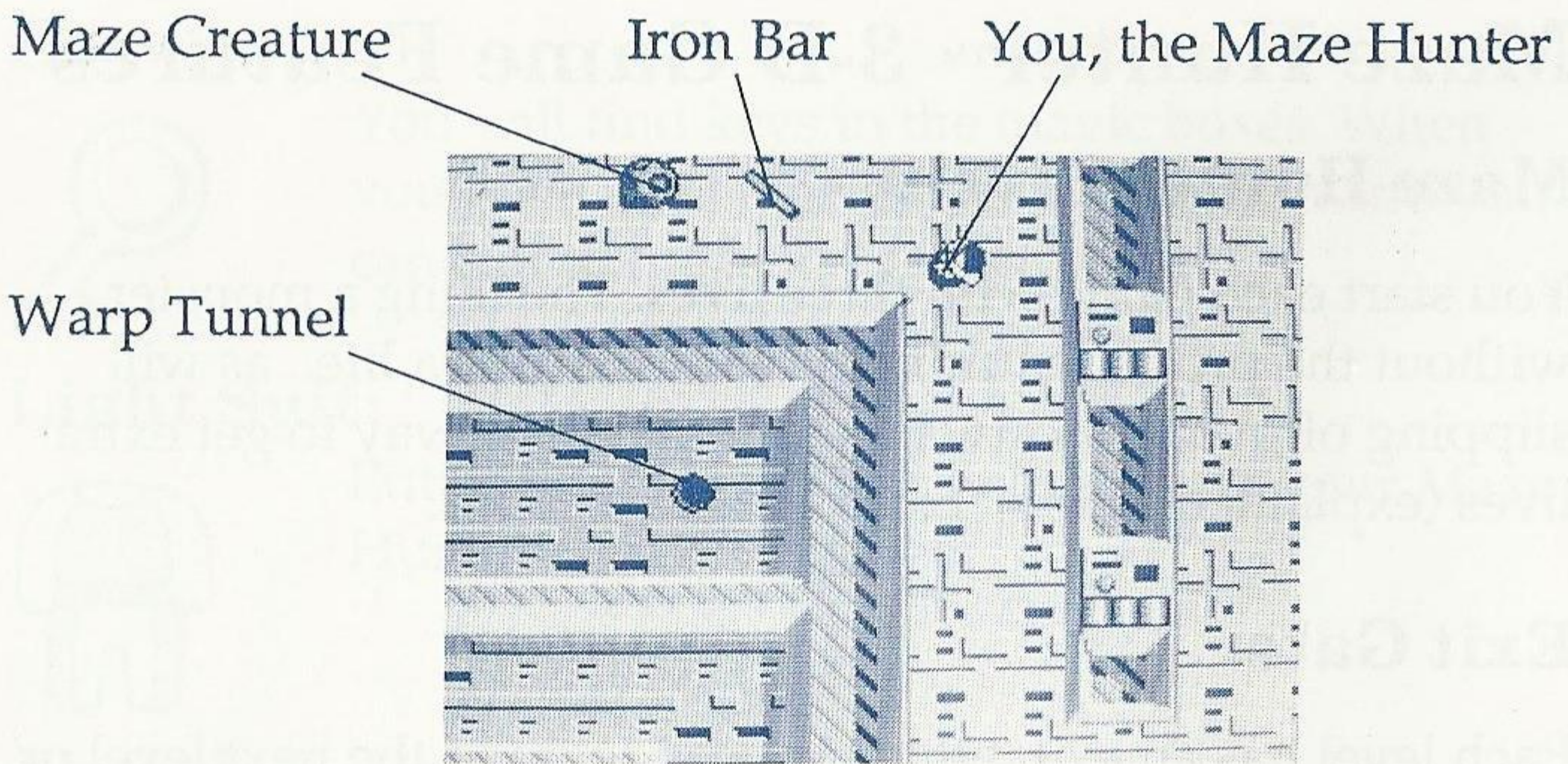

Iron Bar:

You can't make it through the game without this item. You can pick up the Iron Bar by moving your character over it. Your Maze Hunter will automatically give it a test swing. This is your weapon. Use it to smash the maze creatures by pressing Button #1!

Jumping:

Pressing Button #2 while you are standing still will make your Maze Hunter jump in place. If you press Button #2 and the D-Button, you will jump in that direction.

Warp Tunnels:

There are Warp Tunnels in every Level. Use them to get to the lower sublevels. You can find them by moving through the maze. To enter the Warp Tunnels, move your Maze Hunter over the tunnel opening. You will be warped to the next sublevel. You can also use the Warp Tunnels to go back to the sublevel you were just on.

Maze Hunter™ 3-D Game Features

Maze Hunter Lives:

You start each game with three lives. Touching a monster without the proper equipment will cost you a life...as will slipping off narrow catwalks. But there is a way to get extra lives (explained in the "Extra Lives" section).

Exit Gate:

Each level has an exit, which is used to go to the next level or area. They are in the shape of a square and can be found in the lowest parts of a level. In some levels, the exit gate is located in the middle of a catwalk suspended over space! One slip will send you spinning off into infinity...and will cost you a life.

Before you can enter an exit gate, you must obtain a KEY. When you find the key, the exit gate will flash white or yellow.

Magic Boxes:



As you fight your way through the labyrinth, you will find boxes marked with a . These magic boxes contain things you need to win the game. To open a box, hit it with your iron bar. Get the items by passing your Maze Hunter over them.

NOTE: If you are killed by a maze creature, you lose your iron bar and any items you have collected.

Key:



You will find keys in the magic boxes. When you have a key, the exit gate will flash and you can exit to the next Level or Area.

Light Suit:

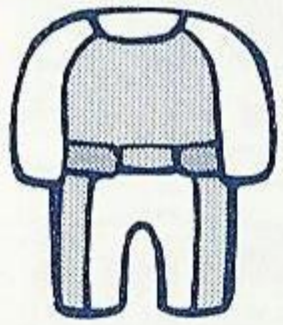

Putting on a Light Suit will increase your Maze Hunter's walking speed.

Absorb Suit:

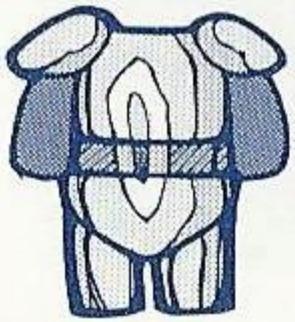

Wearing this suit will protect you from contact with the maze creatures. With the Absorb Suit you can be touched 3 times before you are vaporized.

Jump Shoes:



Jump Shoes let you stay in the air longer and jump much further. If you want to jump a short distance, hold down Button #2 and release it when you want to come down.

Power Shoes:



Put on the Power Shoes and you'll be able to smash maze creatures by jumping on them! But be careful...you'll still get vaporized if the creatures bump you!

Spike Shoes:



You'll get the Spike Shoes in the Ice Area. Wearing them will let you move through the Ice Levels without slipping.

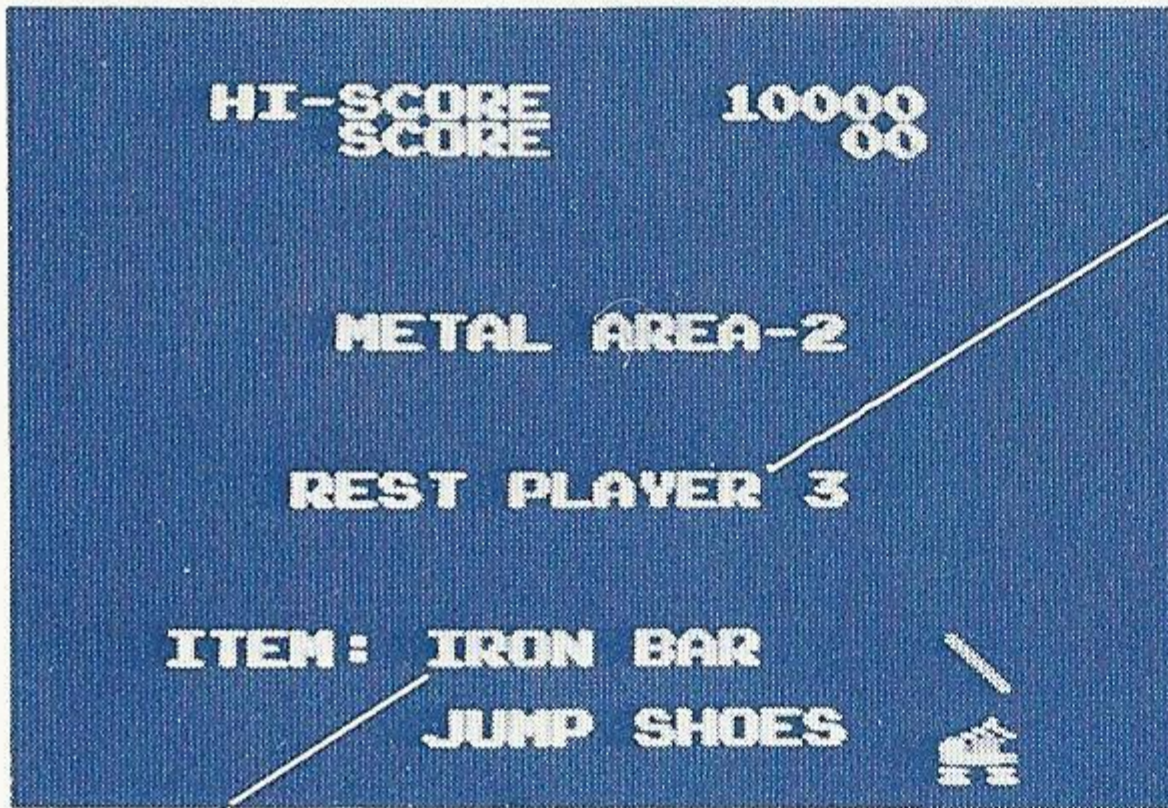

Remaining player(s)

The item(s) you have.

Let's go to the next round!

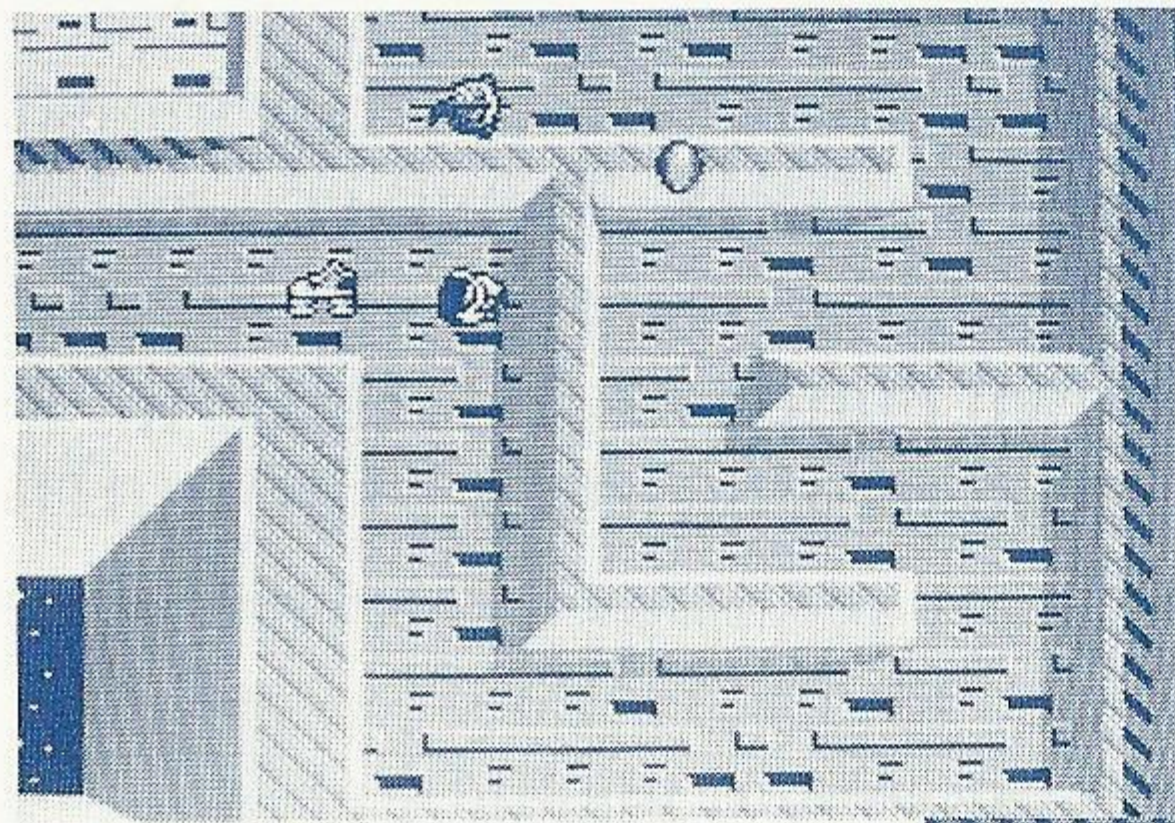
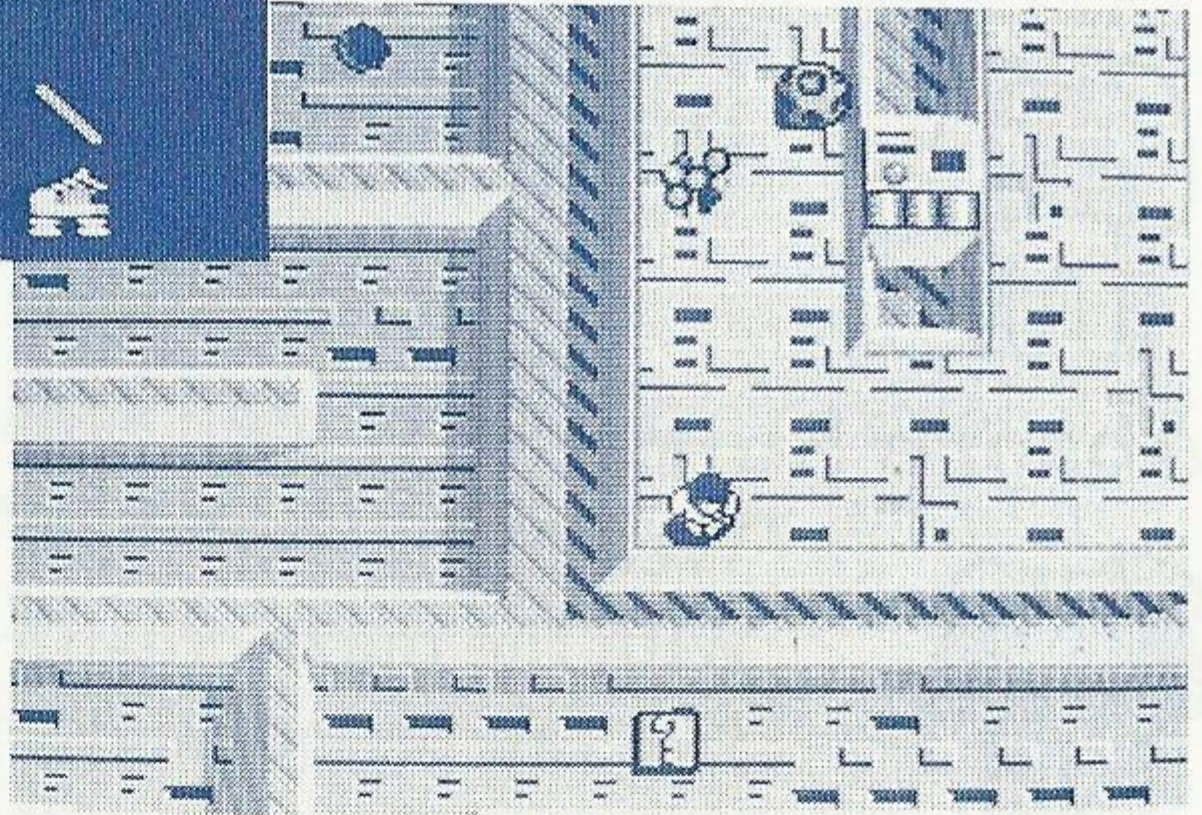

There it ? is!

Here comes the balloon!

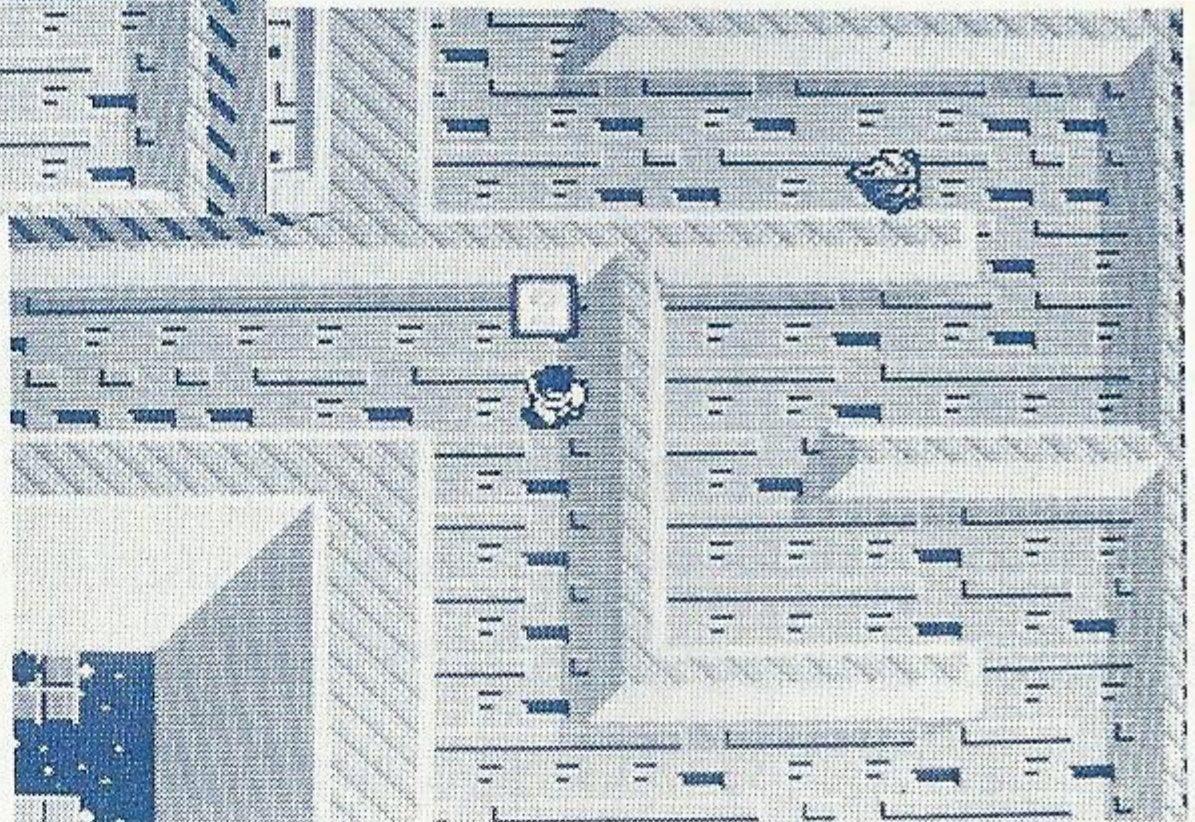

Oh, a 2-way shot!

Balloons:

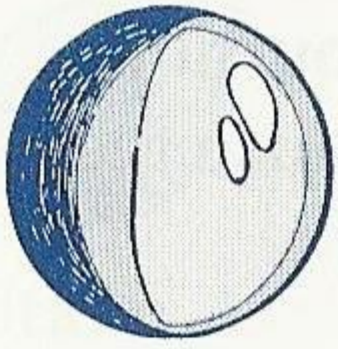

From time to time you will see a balloon floating above the maze walls. Special items you need are hidden inside the balloons. To get them, wait until the balloon stops, then jump up and hit it with your iron bar. When the item appears, jump up again to claim it. If you don't claim the items quickly, they will disappear.

Super Shot:



When you have this item, you will flash for a short period of time. While flashing, press Button #1 and you will fire a burst that will shoot through any number of maze creatures before it hits a wall.

Two-Way Shot:



You will also flash when you get this item. Press Button #1 and you will shoot forward and backward at the same time. But each burst can kill only one maze creature.

Transport:



When you have this item and press Button #1, you will be transported to the nearest warp tunnel on the level you are in.

Maze Mine:



When you have this item and press Button #1, every maze creature on the screen will be instantly exterminated. This item can come in very handy. Use it to your advantage.

Maze Creatures:

These are the creatures who will try to stop your journey through the Labyrinth. Show them no mercy...because they are out to get you!

Roller 600 points Advances by rolling forward.



Kluster 200 points Moves by adjusting itself to your movements.

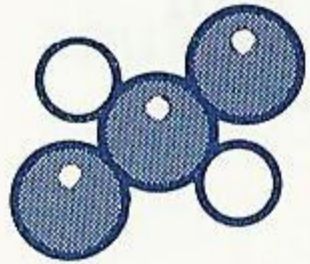

Trog 200 points If you don't kill it quickly, Trog will chase you.

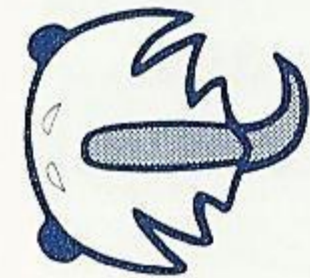

Polyp 700 points Doesn't move, but spits out balls that kill with a touch!



Maru 400 points Blue and Red. Maru is hard to see...and hard to hit!



Squib

600 points

A slimy creature that moves fast!



Utane

400 points

Utane will chase you slowly until it catches you...or you smash it!



Maimer

1,000 points

It moves randomly...but always stops near you!

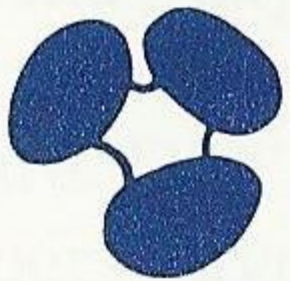

Thunder
Cloud

1,000 points

Attacks by shooting lightning in wide arcs. You can destroy it by jumping and striking with the iron bar.



Goom

400 points

Follows you very slowly.

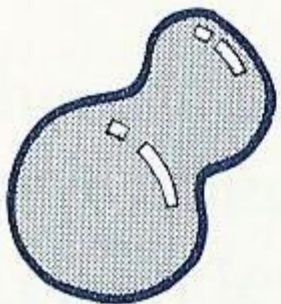

Spinner

200 points

Careful! This one moves very fast.



Bounder 600 points



Bounces through the Labyrinth, killing whatever it strikes.

Eye 1,000 points

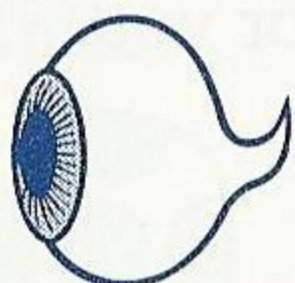

Advances only forward...with diabolical pressure!

Tyro 800 Points



Moves fast and changes directions suddenly.

Fire Ray 400 points



Will chase you if your back is turned.

Extra Lives:

When your Maze Hunter picks up an iron bar, he automatically gives it a test swing. If you can time it so the test swing kills a maze creature, you will get an extra life. (HINT) Face the direction the creatures are coming from before you pick up the iron bar. Timing is the key.

Continuing the Game:

It may happen that you are several rounds into the game and lose your last Maze Hunter to a marauding maze creature. Don't despair! The mythical SEGA Labyrinth Engineers have made it possible to continue where you left off!

To continue the game, wait until the title screen reappears. Then press Buttons #1 and #2 with the D-Button turned up and to the left. You will see

1	1
---	---

 in the upper right corner. The number on the left is the area number. The right number is for the level. Use the D-Button to select the level you were at. Then press Button #1 or #2 to start the game.

The continue mode will work as long as the power supply is not turned off. But you can continue only as high as the highest level you have already played.

Helpful Hints

- When you first start to play Maze Hunter™ 3-D, the game speed may seem slow. This is deceptive. In order to win at Maze Hunter 3-D™, you'll have to learn how to react quickly to rapidly changing conditions.
- The maze creatures can and will appear anywhere...at any time. They flicker into existence with no warning...even under your feet!
- One of the keys to winning is; learn the characteristics of the maze creatures and fight them accordingly.
- Vertical Jumping: In narrow spaces, you can avoid the maze creatures by jumping straight up.
- Running and Jumping: If you press Button #2 while moving forward, your jump will carry you past the maze creatures.
- Don't be misled by the shadow of moats and pillars. In SegaScope™ 3-D, the maze looks real enough to fall into! Judge your walking course by the way the maze feels; not the way it looks.

Handling The Mega Cartridge™

- The Mega Cartridge is intended exclusively for the Sega System™.
- Do not bend, crush or submerge in liquids.
- Do not leave in direct sunlight or near a radiator or other source of heat.

Scorebook

Date				
Name				
Score				

Date				
Name				
Score				

Date				
Name				
Score				

Date				
Name				
Score				

Scorebook

Date				
Name				
Score				

Date				
Name				
Score				

Date				
Name				
Score				

Date				
Name				
Score				

90-Day Limited Warranty Sega® Card/Cartridge

To validate the following 90-day limited warranty, your sales slip or proof of purchase should be retained at time of purchase and presented at time of warranty claim.

90-Day Limited Warranty

Sega of America, Inc. warrants to the original consumer purchaser that this Sega Card™ / Cartridge™ shall be free from defects in material and workmanship for a period of 90 days from the date of purchase. If defect covered by this warranty occurs during this 90-day warranty period, Sega will repair or replace the defective card/cartridge, at its option, free of charge.

This warranty does not apply if the defects have been caused by negligence, accident, unreasonable use, modification, tampering or any other causes not related to defective materials or workmanship.

To receive fast, reliable service, call the Sega Customer Service Department at the following numbers:

Outside California: 800-USA-SEGA

Inside California: 415-742-9300

Our Customer Service Department is in operation from 9:00 AM to 5:00 PM (Pacific Time), Monday through Friday. *Do not return your Sega Card/Cartridge to your retail seller.*

Sega's service center is located at the following address:

Sega of America, Inc.

Warranty Repair

573 Forbes Blvd.

South San Francisco, CA 94080

Limitations On Warranty

Any applicable implied warranties, including warranties of merchantability and fitness for a particular purpose, are hereby limited to ninety days from the date of purchase and are subject to the conditions set forth herein. In no event shall Sega of America, Inc. be liable for consequential or incidental damages resulting from the breach of any express or implied warranties.

The provisions of this warranty are valid in the United States only. Some states do not allow limitations on how long an implied warranty lasts or exclusion of consequential or incidental damages, so the above limitations of exclusion may not apply to you. This warranty provides you with specific legal rights. You may have other rights which vary from state to state.

Sega Customer Service, 573 Forbes Blvd., South San Francisco, CA 94080

Inside California (415) 742-9300
Outside California (800) USA SEGA

Distributed by Tonka™ Corporation
6000 Clearwater Drive,
Minnetonka, MN 55343

SEGA®
FROM TONKA

SEGA, SEGASCOPE 3-D, MAZE HUNTER.

A 3-D CARTRIDGE, and SEGA 3-D GLASSES are trademarks of Sega Enterprises, Ltd., a CSK Group Company.

PRINTED IN JAPAN

© 1988 Tonka Corp. All Rights Reserved.