

Alex Kidd

in Shinobi World





Loading Instructions

Starting Up

1. Make sure the power switch is OFF.
2. Insert the game cartridge in the Power Base (shown below) as described in your SEGA SYSTEM manual.
3. Turn the power switch ON. If nothing appears on the screen, turn the power switch OFF, remove the cartridge and try again.
4. At the title screen, press Button 1 or 2 to start the game.

IMPORTANT: Always make sure the Power Base is turned OFF when inserting or removing your Mega Cartridge.

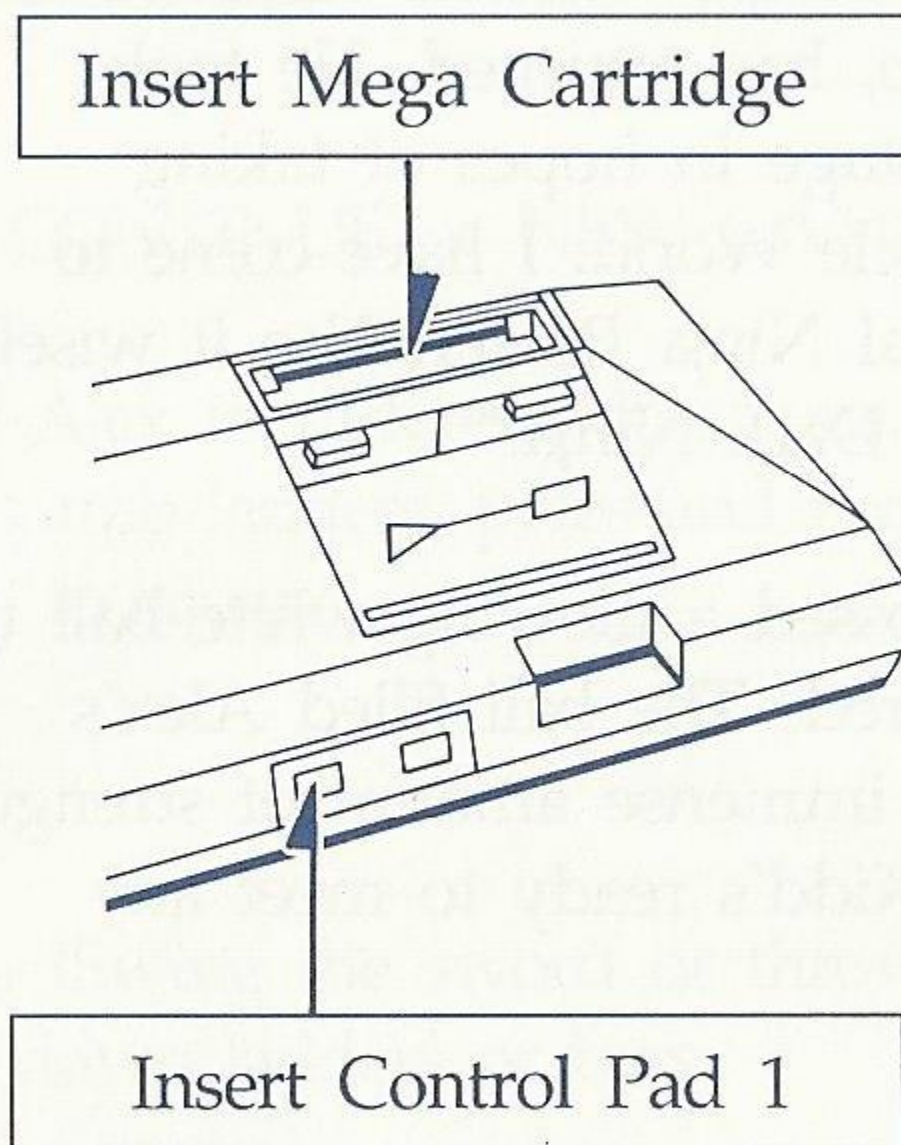

Alex Kidd in Shinobi World

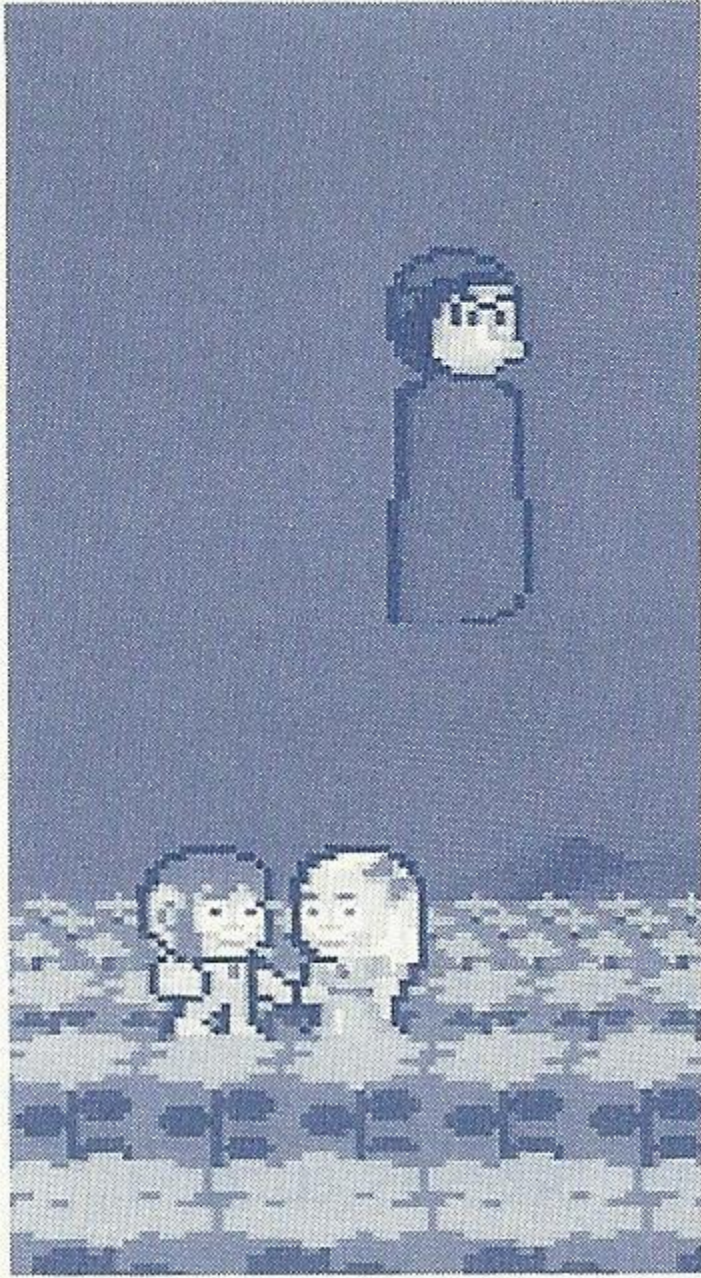

Alex was having the time of his life, spending a lovely afternoon with his girlfriend on the planet Shinobi. Suddenly, gray clouds covered the sky. With a flash of lightning a dark figure descended, grabbed the girl and in no time disappeared into thin air.

Before Alex could figure out what had happened, there was another flash of lightning. This time a White Ninja appeared. Alex looked up as the White Ninja spoke.

“The wicked Dark Ninja, whom I banished ten thousand years ago, has returned. He took your girlfriend hostage in hopes of taking control of the Miracle World. I have come to give you my special Ninja Power. Use it wisely to exterminate the Dark Ninja!”

The White Ninja tossed a glowing white ball to Alex and disappeared. The ball filled Alex’s tiny body with an immense amount of strength and courage. The Kidd’s ready to meet any challenge – again!

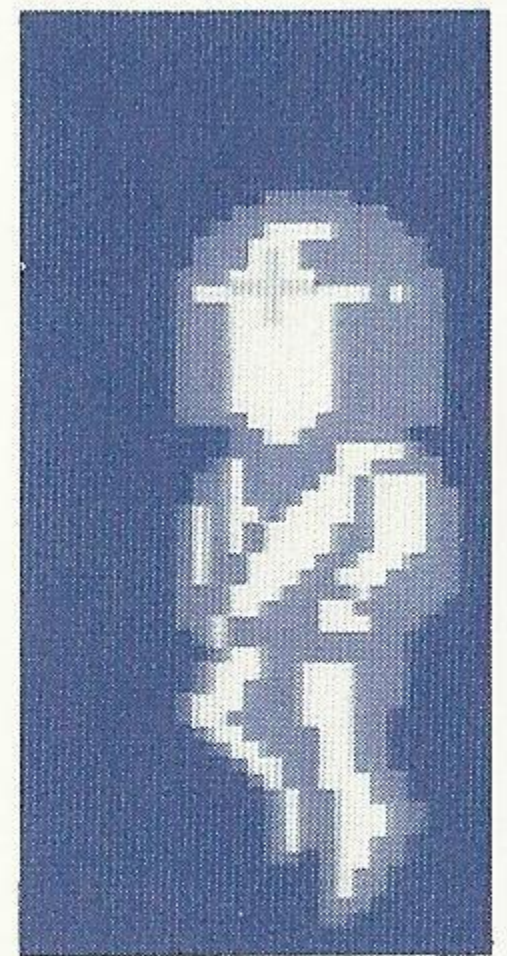

How to Use Your Control Pad

Alex Kidd in Shinobi World is a 1 Player game using Control Pad 1 only. Learn how to use your Control Pad before you start playing.

Control Pad Buttons

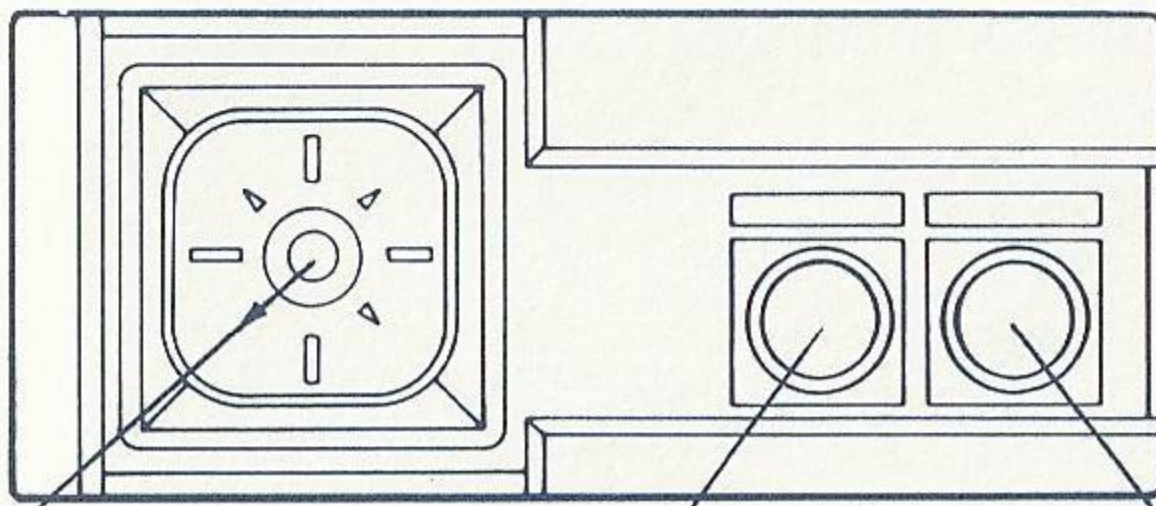

**Directional Button
(D-Button)**

Button 1

Button 2

D-Button

- Press to select CONTINUE or NEW GAME on the GAME OVER screen.
- Press to move Alex in different directions.
 - Press UP to climb ladders, poles and ropes.
 - Press DOWN to squat.

Button 1

- Press to attack. (Swing the sword or throw darts.)
- Press to come down ladders or bars.
- Press to start the game.
- Alex changes from a ball of fire back to his original form.

Button 2

- Press to jump.
- Press to start the game.
- Alex changes from a ball of fire back to his original form.

D-Button (DOWN) + Button 1

- Swing the sword while squatting.
- Throw darts while squatting.

D-Button (UP) + Button 2

- Jump and grab a horizontal bar.

Lives

You have three chances to complete each round. And you get three lives in each section.

Increase the number of lives by picking up extra hearts. You can carry up to six hearts.

You can acquire additional chances to complete each round by picking up an ALEX DOLL. Whenever you have six hearts, the next life-giving item you pick up from the treasure chest will be an ALEX DOLL. Increase the number of chances by picking up as many ALEX DOLLS as possible.

Continue Play

If you wish to continue, select CONTINUE on the GAME OVER screen and press Button 1 or 2. You'll resume play from the first section of the round where you left off.

If you select NEW GAME and press either Button 1 or 2, the title screen will appear.

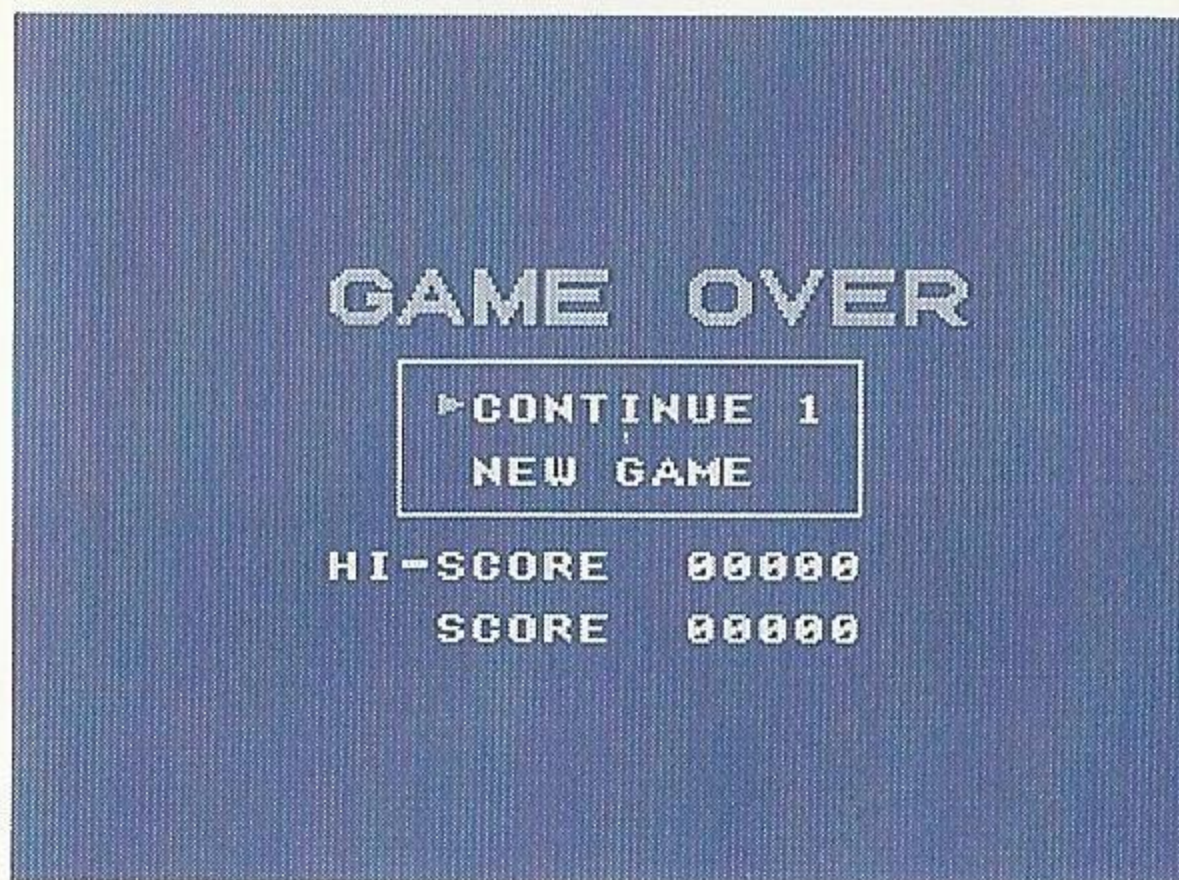

How to Start

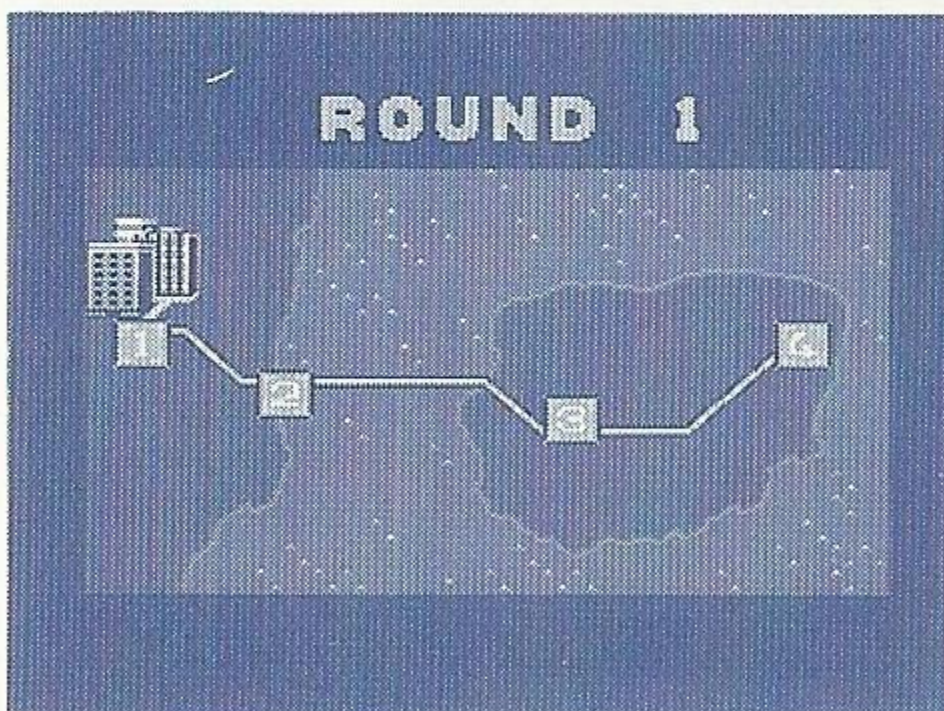

Overall Map

If you press either Button 1 or Button 2 on the introduction screen, you'll see the overall map and then the ROUND INFO screen. The ROUND INFO screen displays the picture of the Boss you have to defeat, the hi-score, your score, how many

chances you have left and where you are in the round. Then you will automatically get to section one of round one.

The flashing square is where you are in the round.

Round Info Screen

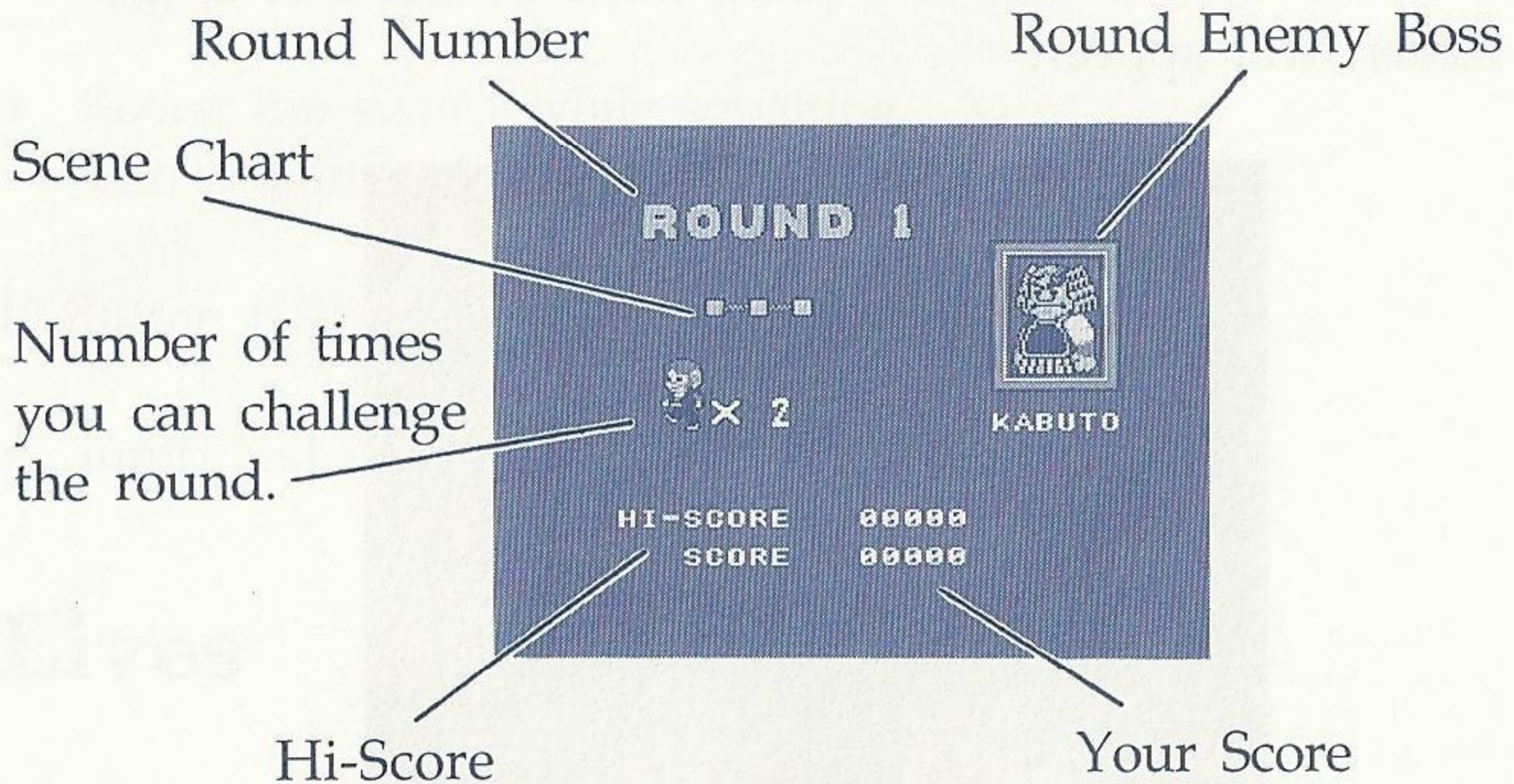

Play Screen

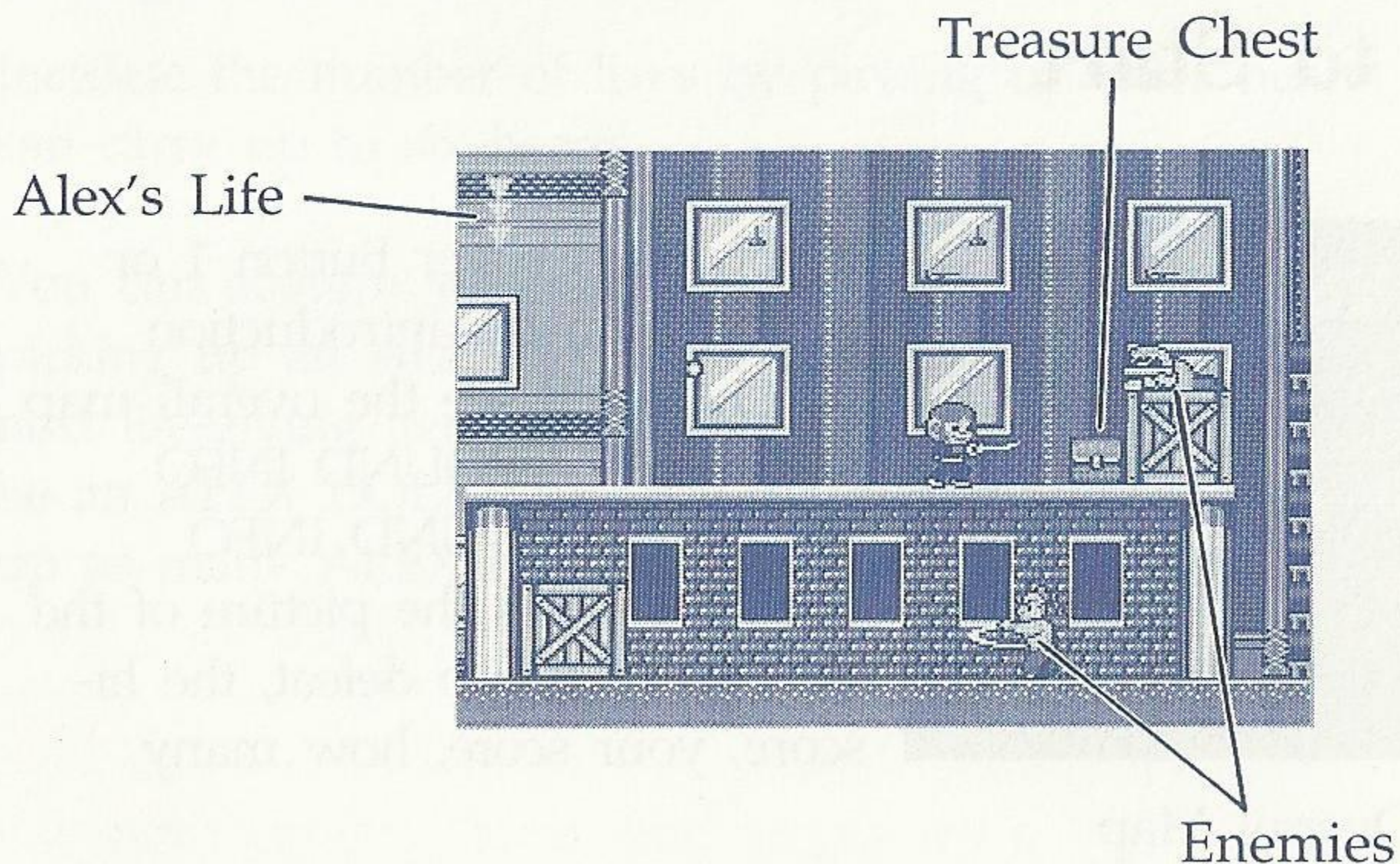

Encounter the Boss

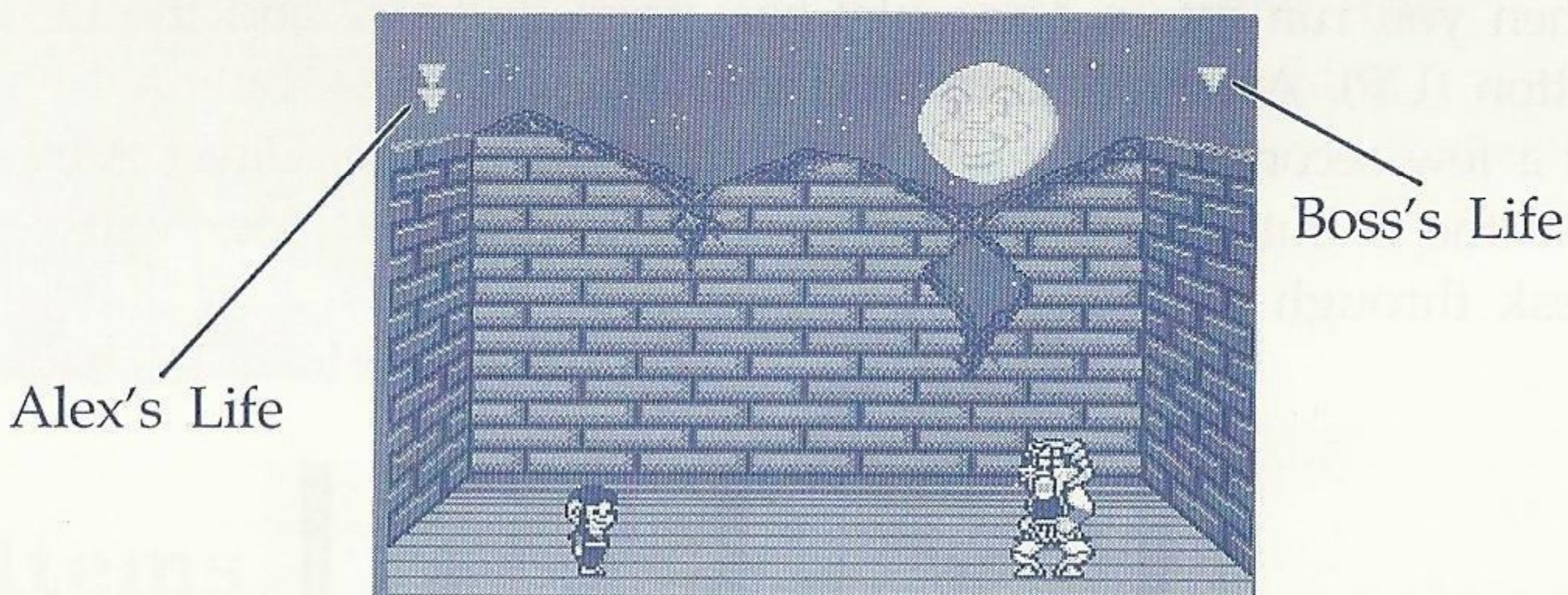

Magic

You'll definitely need to use magic to knock down your enemies and elude traps.

Fireball

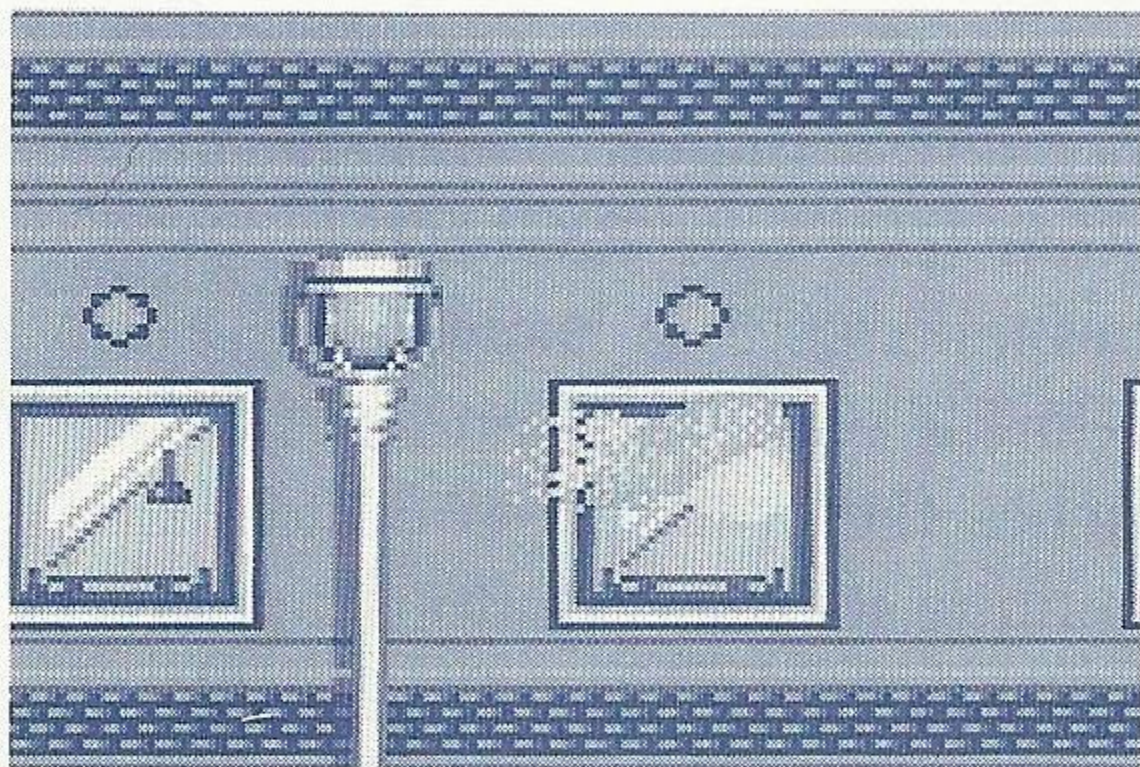

When you run into a hanging rope or a pole, stand in front of it. Press the D-Button (UP) to start climbing. Stop at an appropriate spot and press Button 1 for a few seconds. Alex will turn into a ball of fire. Direct Alex with the

D-Button (LEFT or RIGHT) and lift your finger off Button 1. Alex will fly to wherever you direct him. If Alex hits weak

enemies they'll be wiped out instantly. The stronger enemies will only sustain damage.

When you run into a horizontal bar, press Button 2 and the D-Button (UP). Alex will jump and grab the bar. Press Button 1 for a few seconds. Alex will turn into a ball of fire. Direct Alex with the D-Button and lift your finger off Button 1. Alex will break through thick walls.

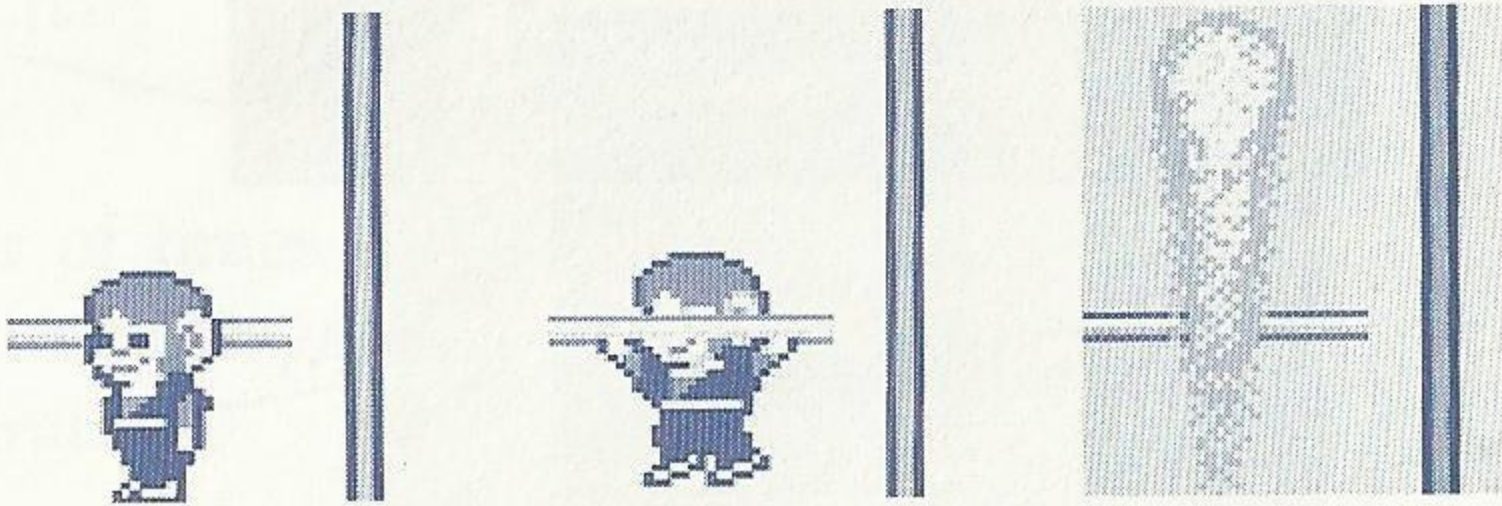

Wall Jump

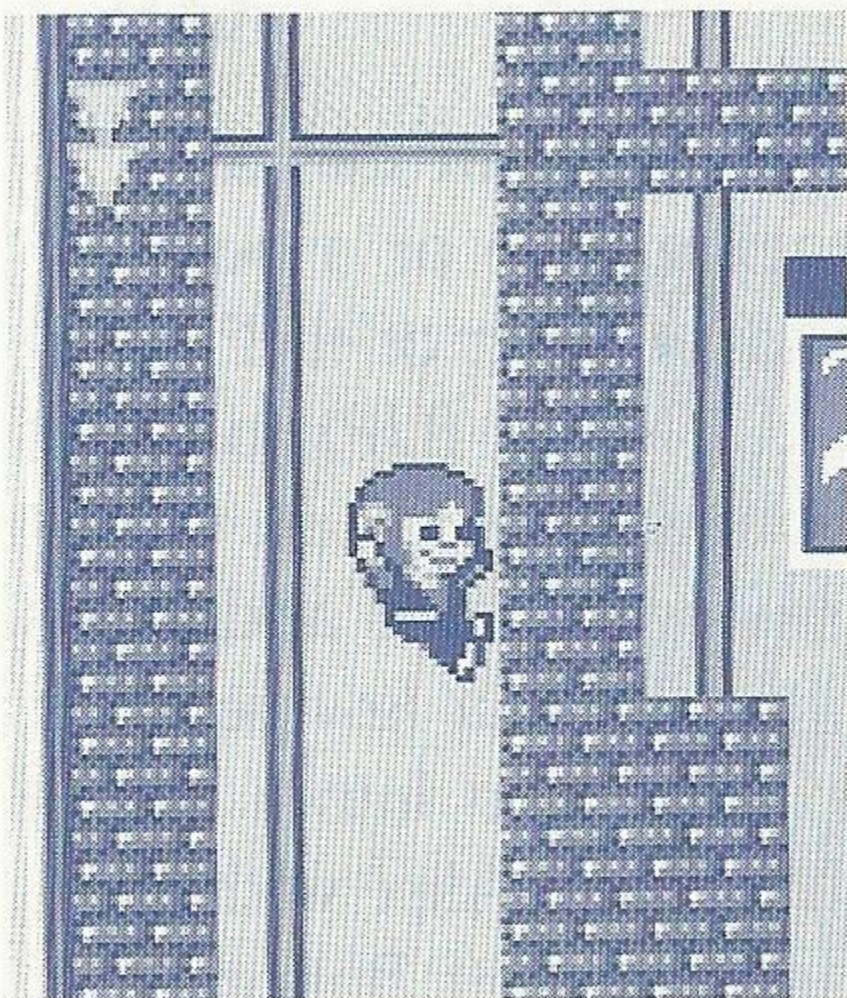

You can use this technique only to climb walls that are facing each other. Press Button 2 and the D-Button (LEFT or RIGHT) simultaneously to make Alex jump toward a wall. As soon as Alex touches the wall, press Button 2. Continue to press Button 2 until Alex gets to the top of the wall.

Skip on Water

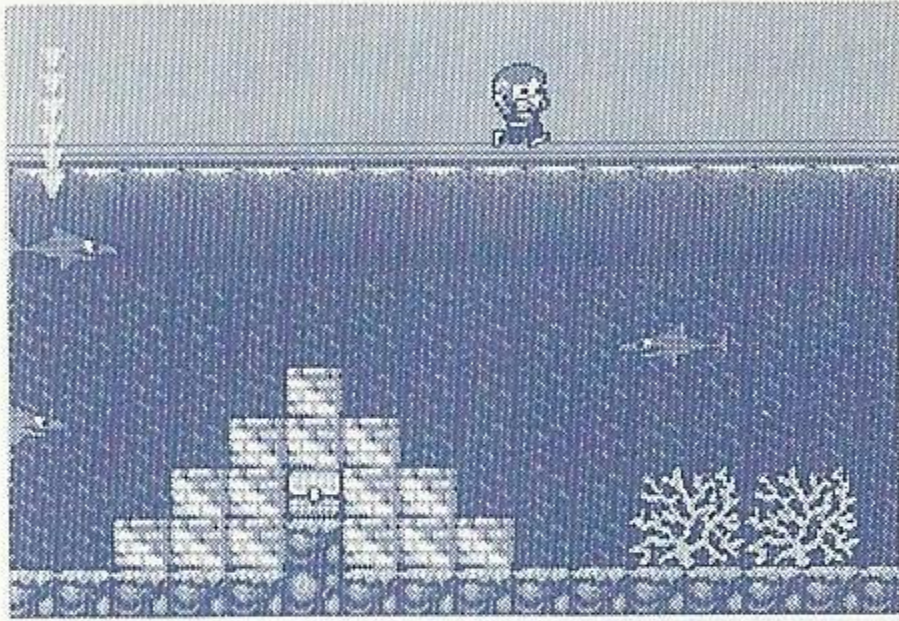

Continue to press Button 2 as Alex crosses a body of water. This prevents him from sinking.

Items

When you find a treasure chest, break it open to pick up useful items.



Heart

Gives you life.



Darts

If you pick these up you'll be able to use darts instead of your sword. If you get attacked or proceed to the next section you will no longer be able to use them.



Power

Your weapon becomes more powerful.



Ninja's Crystal Ball

Alex turns into a tornado. Use the D-Button to direct the tornado. (When Alex turns into a tornado, smaller twisters also appear. These twisters cannot be controlled.)

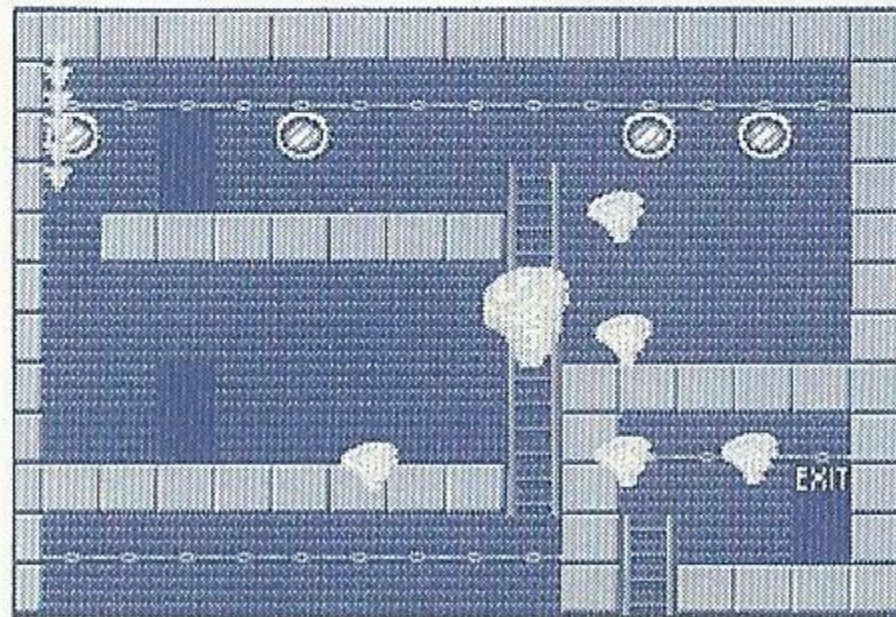

Alex Doll

You gain an extra chance to complete a round.

Rounds

You must go through four rounds to complete this game. Each round is divided into three sections.

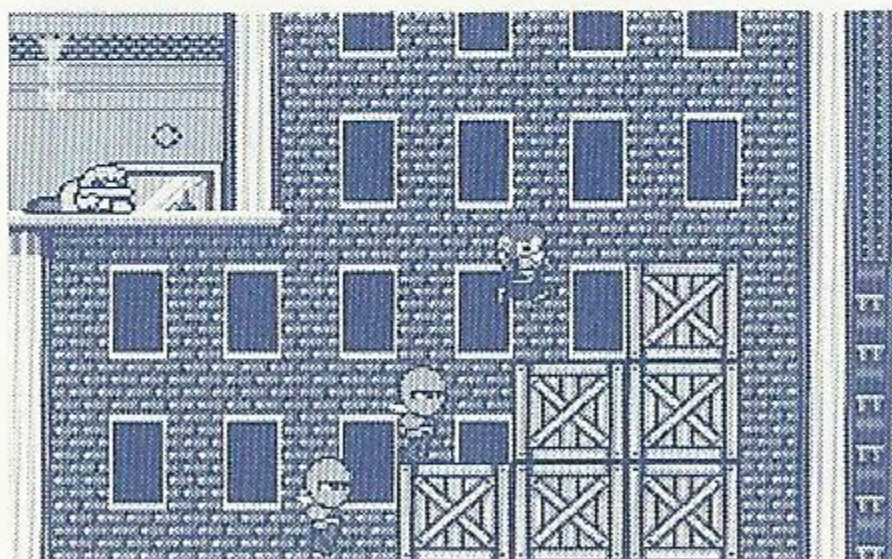

Round 1: Kabuto

Kabuto, the Boss, attacks by throwing balls of fire. You can kill him by hitting him several times with your weapon. But it's not going to be as easy as it sounds. First you have to get rid of the enemies in the city.

Round 2: Raid of the Helicopters

In order to rescue the hostage, you must go through the harbor. It's not going to be easy because the entire area will be crawling with enemies.

In order to clear this round, you must destroy the helicopters that come flying at you. The total number of helicopters will be indicated on the screen.

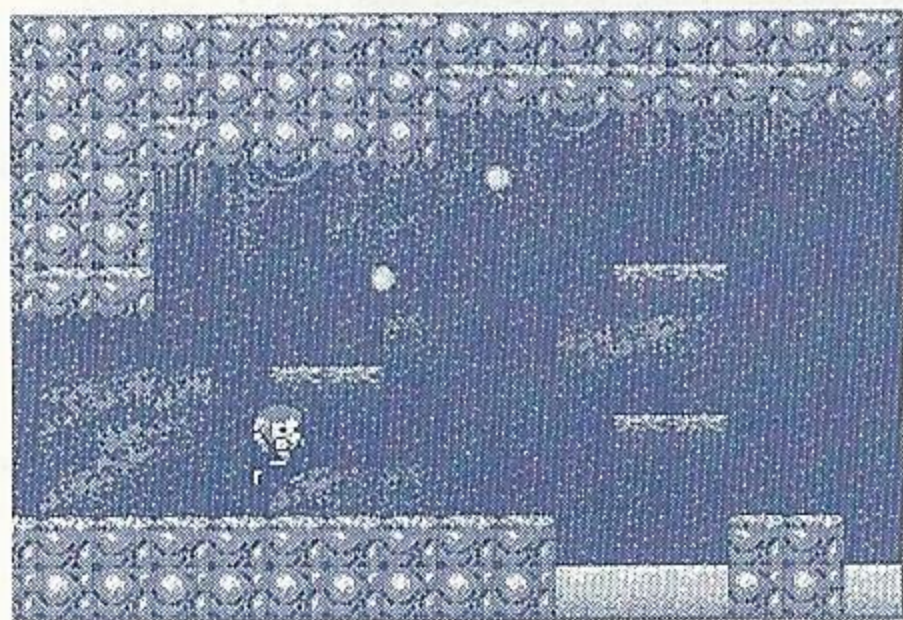
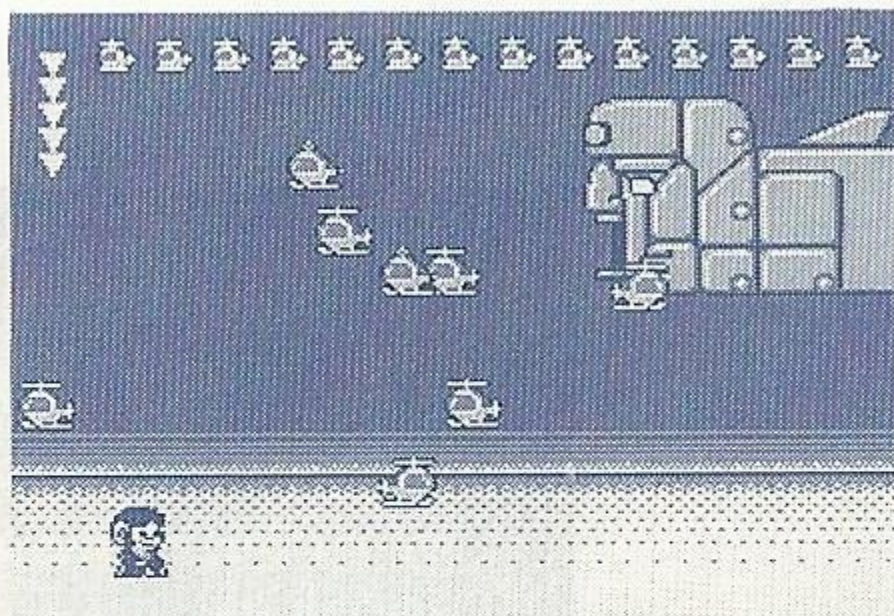

Round 3: The Jungle

The jungle is full of surprises. See if you can elude all the traps.

Attack the Boss four times and see what happens!

Round 4: The Battle with the Dark Ninja

You must first destroy several enemies whom you have fought in the previous rounds before you confront the Dark Ninja.

Exterminate the Dark Ninja and rescue your girl!

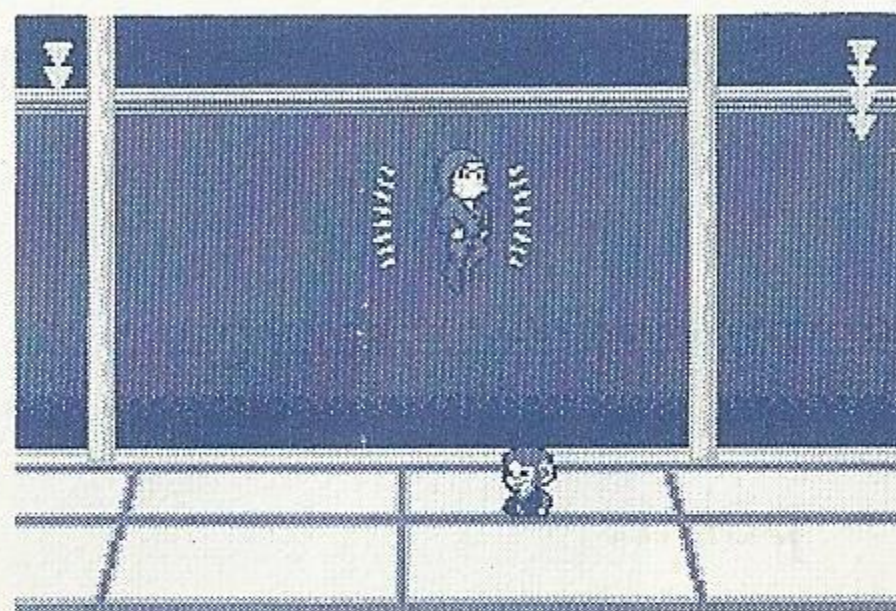

Scoring



- You'll gain 100 points for killing each enemy and 1,000 points for killing each Boss Ninja. The score appears at the beginning of the following round.
- **CLEAR BONUS**
If you clear a round, you'll get 2,000 points for every life you have left.
- **PERFECT BONUS**
If you clear a round with six lives left, you'll get 10,000 points.
- **SECRET BONUS**
If you clear a round without sustaining any damage, you'll get 10,000 points.

Note: You won't gain any extra points for clearing Round 4 without damage.

Helpful Hints

- Good timing is the key to success.
- Look for secret routes to get to the treasure chests in hard-to-get places.
- Learn your enemies' movement patterns.
- Use your weapon to break through flashing blocks. Squat and break blocks under your feet.
- In order to kill the Boss enemies you must attack them several times. Find their weak spots.
- You won't be able to open treasure chests by throwing darts from a distance. You must stand in front of them to break them open.

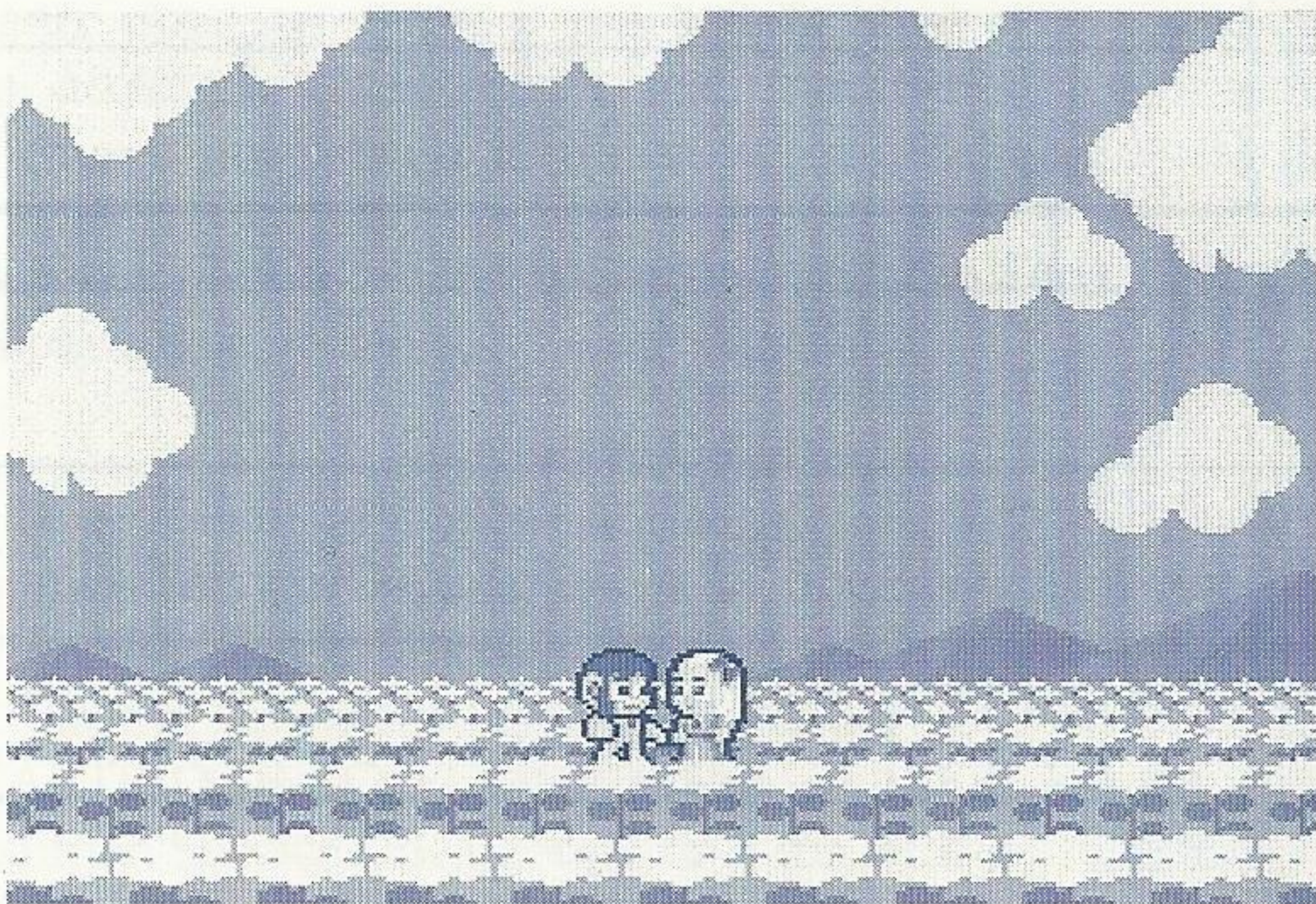

Scorebook

| | | | | |
|-------|--|--|--|--|
| Date | | | | |
| Name | | | | |
| Score | | | | |

| | | | | |
|-------|--|--|--|--|
| Date | | | | |
| Name | | | | |
| Score | | | | |

| | | | | |
|-------|--|--|--|--|
| Date | | | | |
| Name | | | | |
| Score | | | | |

| | | | | |
|-------|--|--|--|--|
| Date | | | | |
| Name | | | | |
| Score | | | | |

Handling This Cartridge

- This Cartridge is intended exclusively for the Sega System™.
- Do not bend, crush or submerge in liquids.
- Do not leave in direct sunlight or near a radiator or other source of heat.
- Be sure to take an occasional recess during extended play.

Warranty

Sega of America, Inc., warrants to the original consumer purchaser that this Cartridge shall be free from defects in material and workmanship for a period of 90 days from the date of purchase. If a defect covered by this warranty occurs during this 90-day warranty period, Sega will repair or replace the defective cartridge or component part, at its option, free of charge.

This warranty does not apply if the defects have been caused by negligence, accident, unreasonable use, modification, tampering, or any other causes not related to defective materials or workmanship.

To receive fast, reliable warranty service, call the Sega Consumer Service Department at the following number:

1-800-USA-SEGA

Our Consumer Service Department is in operation from 6:00 a.m. to 9:00 p.m. (Pacific Time), Monday through Friday and from 8:00 a.m. to 6:00 p.m. (Pacific Time), Saturday and Sunday. **DO NOT RETURN YOUR CARTRIDGE TO YOUR RETAIL SELLER.** Return cartridge to Sega Consumer Service. Please call first for further information.

If the Sega technician is unable to solve the problem by phone, we will provide you with instructions on returning your defective cartridge to us. The cost of returning the cartridge to Sega's Service Center shall be paid by the purchaser.

Repairs After Expiration of Warranty

If your Cartridge requires repairs after termination of the 90-day warranty period, you may contact the Sega Consumer Service Department at the number listed above. If the technician is unable to solve the problem by phone, he will advise you of the estimated cost of repair. If you elect to have the repair done, you will need to return the defective merchandise, freight prepaid and insured against loss or damage, to Sega's Service Center with an enclosed check or money order payable to Sega of America, Inc. for the amount of the cost estimate provided to you by the technician. If, after inspection, it is determined that your cartridge cannot be repaired, it will be returned to you and your payment will be refunded.

Limitations on Warranty

Any applicable implied warranties, including warranties of merchantability and fitness for a particular purpose, are hereby limited to ninety days from the date of purchase and are subject to the conditions set forth herein. In no event shall Sega of America, Inc., be liable for consequential or incidental damages resulting from the breach of any express or implied warranties.

The provisions of this warranty are valid in the United States only. Some states do not allow limitations on how long an implied warranty lasts, or exclusion of consequential or incidental damages, so the above limitation or exclusion may not apply to you. This warranty provides you with specific legal rights. You may have other rights which vary from state to state.

©1990 Sega of America, Inc.
Sega of America, Inc. P.O. Box 2167, South San Francisco, CA 94080
Printed in Japan