

# STEALTH ACTION REDEFINED

As Sam Fisher, you act alone outside the boundaries of law to thwart terrorist attacks against the United States.

**Never seen before moves:** Rappel, split jump, glide along ziplines, force information from your enemies, or use them as human shields, and other dirty tricks.

**Cutting-edge technology:** Use prototype guns, night and thermo-vision goggles, fiber-optic cameras, electric shockers, and more.

And remember: The choice between leaving a witness or a dead body isn't a choice at all.

## Tom Clancy's **SPLINTER CELL**

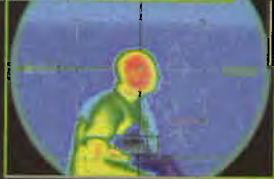
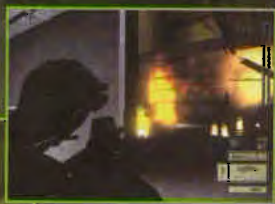

Coming November 2002



©2002 Ubi Soft Entertainment. All Rights Reserved. Splinter Cell, Ubi Soft, and the Ubi Soft logo are trademarks of Ubi Soft Entertainment in the U.S. and/or other countries. All other trademarks are the property of their respective owners.

Microsoft, Xbox and the Xbox Logos are either registered trademarks or trademarks of Microsoft Corporation in the U.S. and/or in other countries and are used under license by Microsoft.

Ubi Soft

Ubi Soft Entertainment  
625 Third Street, Third Floor  
San Francisco, CA 94107  
PRINTED IN USA

# XBOX

LIVE ONLINE ENABLED

TOM CLANCY'S



## GHOST RECON

SQUAD-BASED BATTLEFIELD COMBAT

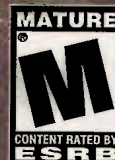

Ubi Soft  
www.ubi.com



## Safety Information

### About Photosensitive Seizures

A very small percentage of people may experience a seizure when exposed to certain visual images, including flashing lights or patterns that may appear in video games. Even people who have no history of seizures or epilepsy may have an undiagnosed condition that can cause these "photosensitive epileptic seizures" while watching video games.

These seizures may have a variety of symptoms, including lightheadedness, altered vision, eye or face twitching, jerking or shaking of arms or legs, disorientation, confusion, or momentary loss of awareness. Seizures may also cause loss of consciousness or convulsions that can lead to injury from falling down or striking nearby objects.

Immediately stop playing and consult a doctor if you experience any of these symptoms. Parents should watch for or ask their children about the above symptoms—children and teenagers are more likely than adults to experience these seizures.

The risk of photosensitive epileptic seizures may be reduced by sitting farther from the television screen, using a smaller television screen, playing in a well-lit room, and not playing when you are drowsy or fatigued.

If you or any of your relatives have a history of seizures or epilepsy, consult a doctor before playing.

**Other Important Health and Safety Information** The Xbox Instruction Manual contains important health and safety information that you should read and understand before using this software.

### Avoid Damage to Your Television

**Do not use with certain televisions.** Some televisions, especially front- or rear-projection types, can be damaged if any video games, including Xbox games, are played on them. Static images presented during the normal course of game play may "burn in" to the screen, causing a permanent shadow of the static image to appear at all times, even when video games are not being played. Similar damage may occur from static images created when placing a video game on hold or pause. Consult your television owner's manual to determine if video games can be played safely on your set. If you are unable to find this information in the owner's manual, contact your television dealer or the manufacturer to determine if video games can be played safely on your set.

Unauthorized copying, reverse engineering, transmission, public performance, rental, pay for play, or circumvention of copy protection is strictly prohibited.

## TABLE OF CONTENTS

Safety Information . . . inside front cover	Quick Missions . . . . .12
Table of Contents . . . . .1	Mission . . . . .12
Connect to Xbox <i>Live</i> . . . . .2	Firefight . . . . .12
Quick Starts . . . . .4	Recon . . . . .12
To Start a New Campaign . . . . .4	Defend . . . . .12
To Start a New Quick Mission . . . . .4	Briefing . . . . .13
To Start a Split-Screen Game . . . . .4	Platoon Setup . . . . .13
To Start or Join a Link Play Game . . . . .5	Selecting Soldiers . . . . .13
To Start or Join an Xbox <i>Live</i> Game . . . . .5	Soldier Skills and Combat Points . . . . .14
The Story . . . . .5	Selecting Kits . . . . .14
Main Menu . . . . .6	Action Interface . . . . .15
Training . . . . .6	Movement and Looking . . . . .15
Campaign . . . . .6	Action Interface Elements . . . . .15
Quick Mission . . . . .6	Command Interface . . . . .17
Options . . . . .6	Command Map . . . . .18
Dossier . . . . .7	Team Orders . . . . .19
Dossiers . . . . .7	Movement ROEs . . . . .20
Select Dossier . . . . .7	Combat ROEs . . . . .20
View Dossier . . . . .7	Split-Screen Play . . . . .20
Options . . . . .8	Link Play . . . . .21
Video and Game . . . . .8	Server Settings . . . . .22
Sound . . . . .8	Game Settings . . . . .22
Controls . . . . .9	Map Selection . . . . .23
Training . . . . .9	Multiplayer Game Types . . . . .23
Obstacle Course . . . . .10	Cooperative Games . . . . .24
Small Arms . . . . .10	Team Games . . . . .24
Grenades . . . . .10	Solo Games . . . . .25
Heavy Weapons . . . . .10	Xbox <i>Live</i> Play . . . . .25
Machine Guns . . . . .10	Quick Match . . . . .25
Demolitions . . . . .10	Optimatch . . . . .26
Command . . . . .10	Create a Match . . . . .26
Campaigns . . . . .10	Default Controller Scheme . . . . .26
Starting a New Campaign . . . . .11	Credits . . . . .27
Loading an Existing Campaign . . . . .11	Technical Support . . . . .28
Saving a Campaign . . . . .11	Warranty . . . . .inside back cover

## CONNECT TO XBOX LIVE

**Important!** Before using this product, read the Xbox instruction Manual for important safety information and health warnings.

### Step 1: Connect

To connect your Xbox console directly to broadband, see diagram A. Or, to share your broadband connection with a PC, see diagram B.

For more details and other home networking options, including Internet connection sharing, see [www.xbox.com/live](http://www.xbox.com/live).

#### A. Direct Connection

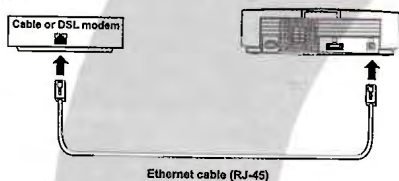

#### B. Shared Connection

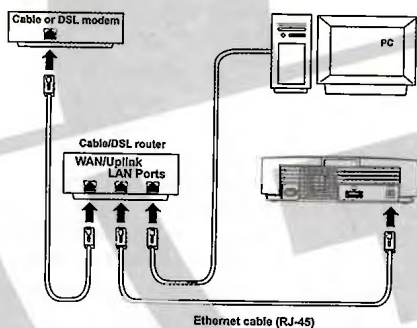

### Step 2: Go Live

**Important!** Xbox Live is a subscription service. You will need a subscription code to set up an Xbox Live account and play online.

To find out how to get a subscription code, visit your local retailer or see [www.xbox.com/live](http://www.xbox.com/live).

You'll need to set up an Xbox Live account to play games online.

Here's how:

1. Insert an Xbox Live Starter Kit disc or game disc into the disc tray. Check game packaging to see if the game supports Xbox Live play.

2. From within the game, select the option for Xbox Live.

At this point, the Xbox console will try to go online. If it works, create your Xbox Live account by following the instructions on screen and entering your subscription code when prompted.

If the Xbox console can't go online automatically, you'll get an error message. Go on to Step 3.

### Step 3: Configure (if necessary)

If you can't go online automatically, use Network Setup in the Xbox Dashboard to enter some network settings. You may need to enter information such as a host name, MAC address, or an ISP user name and password. Contact your broadband service provider if you don't have this information. Once you have the information, enter it in the Xbox Dashboard.

#### Need more help?

Should you have any problems connecting to the Xbox Live service, do not attempt to take apart, service, or modify the Xbox console or peripherals in any way. Doing so could present the risk of serious injury or death from electric shock or fire, and will also void your warranty. For additional assistance see

[www.xbox.com/live](http://www.xbox.com/live) or call the Customer Support number:

- United States and Canada: 1-800-4MY-XBOX (1-800-469-9269)
- TTY users (requires special equipment for hard of hearing):  
United States and Canada: 1-866-740-9269 or 1-425-635-7102



## QUICK STARTS

### **To Start a New Campaign:**

Select CAMPAIGN from the Main Menu.  
Select NEW CAMPAIGN from the Campaign Menu.  
Select NAME ENTRY and enter the Campaign Name using the virtual keyboard.  
Select DIFFICULTY and set the desired difficulty level.  
Select PROCEED and you will be taken to the Briefing Screen for the First Mission in the Campaign.

### **To Start a New Quick Mission**

Select QUICK MISSION from the Main Menu.  
Select NEW QUICK MISSION from the Quick Mission Menu.  
Select MAP and pick the Map on which you wish to play a mission.  
Select DIFFICULTY and set the desired difficulty level.  
Select GAME TYPE and choose the type of mission you would like to play.  
Select PROCEED and you will either be taken to the Briefing Screen for the mission, or the Platoon Setup Screen, depending on the type of mission you are playing.

### **To Start a Split-Screen Game**

Select MULTIPLAYER from the Main Menu.  
Select SPLIT-SCREEN PLAY from the Multiplayer Menu.  
Player 1 should press up on their left thumbstick, and then press left and right on their left thumbstick to select the Dossier for their controller.  
Player 2 should press up on their left thumbstick, and then press left and right on their left thumbstick to select the Dossier for their controller.  
Both players press the A Button to lock in their selection and advance to Session Setup.  
Player 1 can set the options for the game session.  
Player 1 should select PROCEED, and both players will be taken to the Platoon Setup Screen.

### **To Start or Join a Link Play Game**

Make sure your Xbox Video Game System is properly configured for a Link Play game.  
Select MULTIPLAYER from the Main Menu.  
Select LINK PLAY from the Multiplayer Menu.  
On the lobby, if you wish to join a game, select a session with your left thumbstick, and press the A Button to join it.  
On the lobby, if you wish to create a game, select a session with CREATE GAME on it using your left thumbstick, and press the A Button to create a session.

### **To Start or Join an Xbox Live Game**

Make sure your Xbox Video Game System is properly configured for an Xbox Live Game.  
Select MULTIPLAYER from the Main Menu.  
Select PLAY LIVE from the Multiplayer Menu.  
If you are not already logged into the service, you will be prompted to log in.  
If you are logged in, you can choose to join an existing session by selecting either QUICK MATCH, or OPTI-MATCH.  
If you wish to start a session, select CREATE A MATCH.

## THE STORY

The year is 2008, and the world teeters on the brink of war. Radical ultranationalists have seized power in Moscow—their goal, the reestablishment of the old Soviet empire. Ukraine, Belarus, Kazakhstan—one by one the nearby independent republics slip back into the Russian orbit. Russian tanks sit in the Caucasus Mountains and the Baltic forests, poised to strike to the south and east. The world holds its breath, and waits.

For one small group of elite soldiers, the war has already begun: U.S. Special Forces Group 5, First Battalion, D Company. Deployed on peacekeeping duty to the Republic of Georgia in the Caucasus, this handful of Green Berets represents the very tip of the spear—the first line of defense. Equipped with the latest battle-field technology, and trained in the latest techniques of covert warfare, they strike—swiftly, silently, invisibly. They call themselves “The Ghosts.”

## MAIN MENU

Once you have powered up your Xbox video game system and inserted the Ghost Recon™ disc, the Main Menu will appear onscreen. It will present you with the choices detailed below. If this is the first time you have started Ghost Recon, you will first be taken to the Dossier screen to create a Dossier. Details on creating a Dossier can be found below. Also, if your Xbox video game system is connected to the Internet and you have an Xbox Live service account, you will be asked if you wish to sign on.



You can press the right trigger from any Menu screen to call up a Help window. This will give you information about the screen you are currently looking at.

### Training

Choose this option to play through the seven training

missions in Ghost Recon. These missions will familiarize you with the controls for Ghost Recon, and teach you how to control your teammates in the game.

### Campaign

Choose this option either to begin a new campaign or to load a previous campaign so that you can resume it where you left off.

### Quick Mission

Choose this option to play through the maps of Ghost Recon in several different play styles, including Mission, Firefight, Recon, and more.

### Multiplayer

Choose this option to take on your friends in head-to-head play, or to play cooperatively through the maps in Mission, Firefight, or Recon modes. More information on these modes of play can be found in the Quick Mission section of the manual.

### Options

Through Options, you can change the settings of the game. This allows you to customize your play experience by adjusting sound, video, and gameplay settings. Full information on Options can be found below in the Options section.

## Dossier

Choose this option to change to a different Dossier, or create a new one. You can also view the Unlocking Task List through the Dossier Screen.

## DOSSIERS

A Dossier is a player profile. It contains information about what tasks you have completed and what rewards you have unlocked as a result. In addition, in link-play mode, the Dossier name serves as your player name. You must have a Dossier created and selected to play Ghost Recon.

The first time you start Ghost Recon, you will immediately be asked to create a Dossier. The game will automatically take you to the Dossier Screen. Simply select the New Dossier option, and use the virtual keyboard to create your Dossier name.

Every Dossier has a rank assigned to it based upon the number of tasks in the task list you have completed while using that Dossier. The ranks range from Private to General. In addition to appearing as part of the Dossier, your rank is displayed to other players when you play through Xbox Live.

By selecting Dossier from the Main Menu, you can get to the Dossier Screen. This screen will allow you to select a different Dossier than the one you're currently playing, create a new Dossier, or just view the Unlocking Task List for your current dossier. Different players will probably want to create individual dossiers for themselves.

### Select Dossier

Choosing SELECT DOSSIER allows you to create a new Dossier by choosing New Dossier and typing in the Dossier name on the virtual keyboard. You can also select an existing Dossier from any save location on your Xbox Video Game System. They will appear in a list.

### View Dossier

There are 50 tasks you can complete in Ghost Recon to unlock new content in the game. Choosing VIEW DOSSIER shows you the status of those tasks. By completing various tasks, you can unlock specialist characters to play, new weapons, new levels for multiplayer play, and more.



## OPTIONS

The options in Ghost Recon control various aspects of how the game plays and looks. All the options are broken down into sets, and selecting a button from the Options Screen will allow you to adjust options in that set. Below is a description of each option, organized according to the set in which it appears.

### Video and Game

- **Brightness:** This setting can affect how bright or dark the game appears. Pressing the A Button with this setting selected will increase the brightness of the game. Pressing the Y Button with this setting selected will decrease the brightness, making it appear darker.
- **Full HUD:** Pressing the A Button on this option will cycle it on or off. When it is on, all elements of the action interface will be present at all times while you are playing a mission. When it is off, some elements will fade out, appearing only when you change soldiers or equipment, or when you exit the command interface.
- **Auto-Aim:** Pressing the A Button will cycle this option on or off. By default, Recruit and Veteran games have auto-aim turned on. This option will override that setting.
- **Combat Points:** Pressing the A Button will cycle this option between Manual and Automatic. If you set it to automatic, combat points will automatically be assigned to soldiers on quick missions, and in the campaign. If you set it to Manual, you will need to assign combat points to soldier skills before missions.

### Sound

Most of the sound options below control the volume of different types of sounds in the game. Pressing the A Button on a sound will increase its volume. Pressing the Y Button on a sound will decrease its volume. No individual sound type can be set louder than the Master volume setting.

- **Music:** This setting controls the volume of all music in the game.
- **Environmental:** This setting controls the sound level of ambient sounds, such as wind and birds chirping. It also controls the volume of the music when you are not in the action phase.
- **Combat:** This setting controls the volume of all combat related sounds, such as gunshots and explosions.

- **Voice:** This setting controls the volume radio chatter, both from AI teammates, and from other players.
- **Output Device:** This setting can be toggled from speakers to headphones by pressing the A Button. It is recommended you leave it on speakers unless you actually have headphones hooked up to your television.
- **Voice Through Speakers:** This option will only be available if you do not have a peripheral that can be used for voice chat. This will allow any voice chat in multiplayer games to come through the speakers of your television.

### Controls

- **Control Scheme:** This setting shows you the controls for the action portion of the game. Pressing the A Button with it selected will cycle through the four available control schemes.
- **Invert Look:** This setting can be toggled on or off by pressing the A Button. When it is on, pressing up on the look thumbstick will cause you to look down. When it is off, pressing up on the look thumbstick lets you look up.
- **Vibration Function:** This setting can be toggled on or off by pressing the A Button. When it is on, you will feel the controller vibrate from various effects, such as nearby explosions.

## TRAINING

Training prepares you for the challenges of the Ghost Recon battlefield. The training sequence is broken down into seven separate missions. Each one starts you at a specific location in the training facility, and each area in the facility is devoted to a specific topic such as small arms, grenades, or giving your teammates orders. You can jump at any time to any area of training, and you can redo each training scenario as many times as you like until you feel comfortable.

### **Obstacle Course**

The Obstacle Course teaches you how to move around in Ghost Recon, including crouching, running, and going prone.

### **Small Arms**

On the Small Arms range, you will learn how to fire most of the weapons in Ghost Recon. This training concentrates on rifles, pistols, and sniper rifles.

### **Grenades**

The Grenade range teaches you how to use hand grenades and grenade launchers in the game.

### **Heavy Weapons**

The Heavy Weapons range teaches you how to use anti-tank rockets in Ghost Recon. This training is important if you have to eliminate armored vehicles to achieve your mission objectives.

### **Machine Guns**

In various places in Ghost Recon, you will come across fixed machine gun emplacements. The Machine Gun range will show you how to use these weapons.

### **Demolitions**

At times, you will be called upon to plant demolitions charges, or to use claymores to accomplish your mission. The Demolitions range teaches you the basics of using explosives.

### **Command**

Coordinating the efforts of your teammates is an essential skill in Ghost Recon. The Command range teaches you how to give your teammates orders by means of the Command Interface.

## **CAMPAIGNS**

Campaign mode in Ghost Recon lets you play the missions in order from start to finish. As you advance in Campaign mode, you build up the stats of your soldiers by assigning them combat points. Combat points are rewards given to soldiers for accomplishing missions. Furthermore, as you accomplish special tasks through the course of the campaign, you can unlock the hero (also known as specialist) characters, who increase the capabilities of your platoon through the use of new weapons and heightened skills.

### **Starting a New Campaign**

To start a new campaign, first, select CAMPAIGN from the Main Menu. Next, select NEW CAMPAIGN. You will be taken to the New Campaign screen, which will allow you to set up your campaign. First, select Difficulty to determine how much opposition you'll face in the campaign. Then, select Name. Doing so will present you with the virtual keyboard, which you can use to enter your campaign's name. Once you type in a campaign name, select ACCEPT to save it. You will then be taken into the briefing for the first mission of the campaign.

Be aware that if you have hero characters unlocked in your Dossier, they will not become available in a particular campaign until you unlock them within that campaign. If you have unlocked additional weapons for hero characters, when you unlock the character in the campaign, all of their weapons will be available for that hero character to use. However, unlocking a specialist in one campaign in your Dossier does not make them automatically and instantly available in another.

### **Loading an Existing Campaign**

To load a previously saved campaign, select CAMPAIGN from the Main Menu. You will be presented with a list of saved campaigns. Simply scroll down to the campaign you wish to play, and select it. This will launch that campaign.

### **Saving a Campaign**

Campaigns can be saved either at the end of a mission or during the action of a mission. At the end of every mission, you will be prompted to save the campaign. You do not have to save over your current campaign, but overwriting that campaign will be the default choice. If you wish to save to a different location, or under a different name, simply select that location, and change the campaign name using the virtual keyboard.

To save a campaign during the action of a mission, press the Start Button. This brings up a menu. Select the SAVE/LOAD option from this menu, and proceed as if you were saving at the end of a mission. When you save during a mission, you will have the option to restart the mission when you load that save. Alternately, you can pick up the action right at the point where you saved.



## QUICK MISSIONS

Every map in the game can be played in several different modes through the QUICK MISSION selection on the Main Menu. If you examine the unlocking task list, you will see another Quick Mission type that you can unlock through play. Each type of quick mission is described below. Note when setting up your platoon in a Quick Mission that all your soldiers will have some Combat Points to spend to beef up their skills. The amount varies depending on the map you select. You can use soldiers without spending their combat points, but doing so makes the quick missions that much more difficult.

To set up a Quick Mission, you will need to select the map you wish to play on, the Quick Mission type, and the difficulty.

### Mission



The Mission Quick Mission type allows you to play through the map in the mission that you would find in the campaign. This will not unlock hero characters, as the specialists can only be unlocked in Campaign mode. The Mission type is also the only Quick Mission type that will give you a briefing for the mission.

### Firefight



In a Firefight mission, your squad is pitted against enemy forces spread out through the map. Your goal is to eliminate all enemy soldiers. You can take a full squad with you, but for an added challenge, try taking on the enemies by yourself. The number of enemies you will face depends on your difficulty setting.

### Recon



Recon mode is similar to Firefight, with enemies scattered across the map. The difference is that your goal is to get all your team members to an extraction zone on the other side of the map.

### Defend



The Defend mission type can be unlocked for each of the maps in the campaign. On a Defend mission, you will need to defend your starting area (also known as your "base") against incoming waves of enemies. If any of the enemy soldiers get into your zone, you will lose the mission.

## BRIEFING

The Briefing screen is broken up in two main sections. To the left is the briefing text itself. This is a transcript of the audio briefing you will hear. To follow along in the text, simply highlight the text box and press the A Button. Then you can scroll through the text using the left thumbstick. Pressing either the A or B Button will take you back out of the briefing text, and allow you to select ACCEPT to continue on past the briefing.

On the right side is mission information. This will include a map of the area, showing the location of every objective on the mission. The map will cycle through each objective, showing pictures of each one. The text for each objective can be found below the map. In addition, you can see the date, time, weather, and location for each mission, giving you some idea of what you'll be facing.

## PLATOON SETUP

After you review the Briefing screen, you will need to set up your platoon properly to complete the mission successfully. Pay close attention to the briefing, as some missions will require you to take along M136 anti-tank rockets or demolitions charges with your demolitions specialists. If a mission requires either one, you will not be allowed to start gameplay until you have assigned at least one demolitions expert with the appropriate equipment.

Every mission has a recommended platoon setup that you can take along if you don't wish to customize your platoon. Simply select the AUTO ASSIGN button at the top of the platoon list, and your platoon will be filled out automatically. As soon as one soldier is assigned to your platoon, the AUTO ASSIGN button will change to UNASSIGN ALL. Selecting UNASSIGN ALL removes all soldiers from the platoon, allowing you to start from scratch.

### Selecting Soldiers

If you don't want to auto assign your platoon, you can select and equip your soldiers individually. By selecting a slot in your platoon roster, you can pick the individual soldier to fill that slot. When you select the slot, you will be taken to a row of icons that represent every soldier. Each soldier will have one of four icons. These icons indicate his class, which dictates what weapons kits he can use. If you move the left thumbstick to the left, you will be presented with all the specialists that you have unlocked. Pressing the left thumbstick to the right will bring you back to the regular soldiers.



 Rifleman

 Support

 Sniper

 Demolitions

As you cycle through the soldier icons, the right-hand side of the screen will update to show you information about each soldier. When the soldier you wish to add to your platoon is current, press the A Button to select him. You will then be able to assign any combat points that he may have, and set up what equipment you wish him to take into the mission. To unselect a soldier, select his spot in the platoon and press Y. You can also simply select a new soldier in that slot, which will automatically unassign the current one.

### **Soldier Skills and Combat Points**

Every time a soldier lives through a mission, he earns one combat point that you can use to raise one of his skills. Each skill has a separate effect on gameplay. The **Weapons** skill determines how fast the reticle pips converge, making for better accuracy and allowing soldiers to recover from recoil faster. The **Endurance** skill reflects how many wounds a soldier can take before becoming incapacitated. Remember however, that one shot in the right place can incapacitate a soldier regardless of how high his endurance rating is. The **Stealth** skill determines how difficult it is for enemy soldiers to detect that soldier. The higher a soldier's Stealth rating, the closer he can get to enemy soldiers before being detected. Finally, the **Leadership** skill affects all of the soldiers on a platoon. For every three points of Leadership that a soldier has, the skills of all of the other soldiers on the platoon are increased by one. Only the soldier with the highest Leadership rating in the platoon has an effect on his teammates.

To raise a skill with a combat point, select the appropriate skill and press the A button. You will see the total number of combat points change. If you made a mistake, simply press the Y Button on that skill to erase the allocation of the combat point, which returns it to the pool of points currently available. Once a soldier goes on a mission, his combat points are locked and cannot be reassigned.

### **Selecting Kits**

To select which kit you wish a soldier to use in a mission, select the Kit box and press the A Button. Every time you press the A

Button, the current kit will cycle, bringing up a new one. Most soldiers will have four kits to select from. Different secondary items will appear, depending on which kit you choose, but in Campaign mode all kits for a particular soldier class have the same primary weapon. If you have unlocked additional weapons for specialists, they will have up to eight kits to choose from.

Once you have assigned combat points and kits, and are satisfied with your platoon assignments, select GO! to launch the mission.

## **ACTION INTERFACE**

### **Movement and Looking**

To move around in the environment, simply use your movement control (defaults to left thumbstick). This will let you go forward, backward, or sideways.

You do not need to look in the direction you are currently traveling in. To move your reticle (see below for what your reticle does), use your reticle control (defaults to right thumbstick). This lets you aim. The further you push the reticle control to one side, the faster your view moves.

### **Action Interface Elements**



**A – Reticle:** The reticle will change according to what weapon you have selected. The pips in the reticle will expand and contract depending on what actions you take. Movement, changing stance, and firing will all cause your reticle to bloom out. When you fire, the pips on the reticle define the target area for your bullet. The smaller the reticle, the more accurate your shot will be.

In combat, you will see red indicators flash around the reticle. These indicate the directions of gunfire. If it is on the top of the reticle, guns are being fired in front of you. If it is beneath the reticle, guns are being fired behind you. If it is on either side of the reticle, guns are being fired in that direction.

To zoom in with your weapon, click your right thumbstick. To zoom back out again, click it again.





### B – Health/Stance Indicator:

This indicator changes color according to the health of your currently selected soldier. Green means he is healthy, yellow means he is wounded, and red means he is dead. In addition, a silhouette quickly lets you know whether the soldier is standing, crouched, or prone.



### C – Team/Class Indicator:

This indicator tells you what class of soldier you are currently controlling. The class icon matches the icons in the Platoon Setup Screens. In addition, it tells you if your soldier is on A or B team. Finally, in multiplayer team games, the color of this indicator will tell you what platoon you are on.



### D – Threat Indicator:

This indicator tells you the direction of enemies. It can also tell you which way is north, and the direction to your next waypoint. Around the outside of the threat indicator is an arrow that will always point North. As you spin in place, the arrow will move around

the indicator. Also around the outside is your waypoint indicator. This will function like the north-seeking arrow, except it will point in a straight line to your next waypoint. The outer circle of the threat indicator will change to yellow to indicate there are enemies in that direction. The center will turn red if an enemy is within 40 meters of your location.

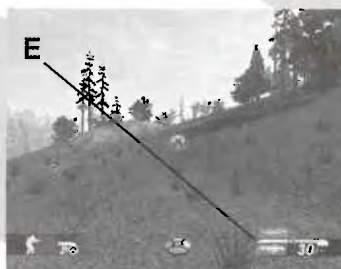

### E – Kit Indicator:

This indicator shows you what your currently active weapon is. In addition, it will show what other kit item you are carrying. The item in gold is the currently active weapon.



### F – Rate of Fire Indicator:

This indicator will show what rate of fire your weapon is currently set to. Your options are Single Shot, Burst Mode, and Full Auto.



### G – Ammo Count Indicator:

The first number in this indicator shows how many rounds you have left in the current clip. The second number shows the total number of clips you are carrying. Some items do not come in clips, and as a result will only show the first number.

## COMMAND INTERFACE

You can call up the command interface anytime in the game by pressing the right trigger. Its default mode is Command Map mode. If you move the left thumbstick, it activates a radial map mode. If you move the left thumbstick, it activates a radial map mode, and puts the Command Interface into Team Orders mode. Releasing the left thumbstick will return the Command Interface to Command Map mode. Pressing the right trigger again will close the Command Interface, and return you to the Action Interface. Unless you are playing a multiplayer game, the game will pause when the Command Interface is active. In multiplayer games, the action continues while the Command Interface is active.



## Command Map

When in Command Map mode, you can order teams around. Moving the D pad moves the cursor around the screen. If you hold down the D pad, the cursor will continue to scroll across the map until it reaches the edge of the map. When the cursor turns red, you are over an area that you cannot place a waypoint in. If the cursor is white, you can place a waypoint.

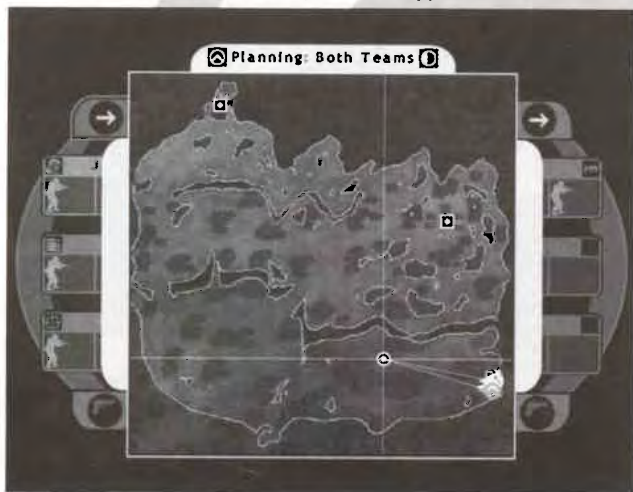

Waypoints are points on the map you wish a team to reach. You can string several waypoints together to set a path for a team. They are placed by pressing the A Button. When a waypoint is set, you will see a path appear from the currently active team to the waypoint. You can tell which team is active by looking at the top of the Command Map. The active team can be changed in Team Orders mode.

If you want to get more precise in where you are placing waypoints, simply click the right thumbstick, as though you are zooming in with a weapon. This will zoom in the map. To zoom back out, click the right thumbstick again.

You can tell a soldier to face a particular direction when he gets to a waypoint by holding down the A Button when placing a waypoint. A fire arc will appear. Use the D pad to change the facing of the fire arc. When you release the A Button, the fire arc will be set. When a team arrives at that waypoint, they will face in that direction.



Around the side of the command map is information about your platoon. A Team members have their information down the left side of the map, while information about B Team can be found on the right side. At the top is an icon depicting the current Movement Rules Of Engagement (ROE) for the team. Below that you will see the health/stance indicator for each team member on that team. This indicator mimics the same indicator in the action interface. Finally, at the bottom is an icon indicating the current Combat ROE for that fireteam. Information about Combat and Movement ROEs can be found in the Team Orders section below.

## Team Orders

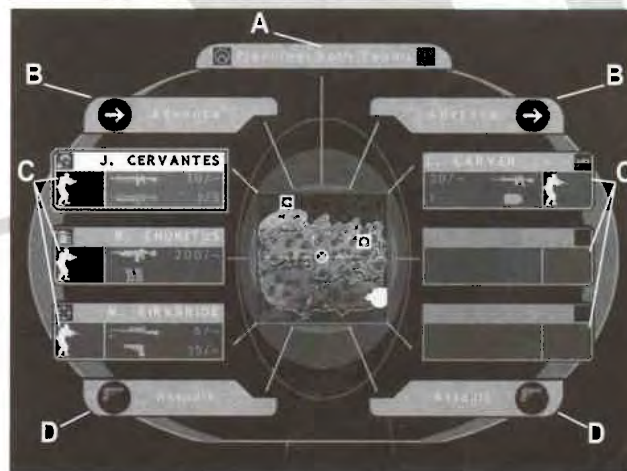

When in Command Map mode, you can enter Team Orders mode by moving the left thumbstick in any direction. Team Orders mode is a radial menu that will allow you to change the current active team, set ROEs for each fireteam, and quickly switch to a particular team member. You will also see more information about each soldier.

**A – Active Team Indicator:** If this button is highlighted, you can change which team is active by pressing the A Button. You can cycle through A Team, B Team, and Both Teams.

**B – Team Movement ROE Indicator:** By highlighting this button, you can change a team's movement ROE. Simply press the A Button to cycle through available movement ROEs.





**C – Soldier Indicator:** The soldier indicator will tell you the name, class, health, stance, and kit of each soldier. To switch to a particular soldier, highlight that soldier and press the A Button. The soldier you are currently playing as will be highlighted to help you identify him.

**D – Team Combat ROE Indicator:** By highlighting this button, you can change a team's combat ROE. Simply press the A Button to cycle through available combat ROEs.



### **Movement ROEs**

A team's Movement ROE determines how their movement is affected by combat.

-  **Hold:** A team on Hold will not move until taken off Hold. It can still be given orders, but will not move to accomplish those orders unless you take it off of Hold.
-  **Advance:** A team on Advance will move normally until it takes fire. Once it is in combat, it will revert to Hold. To get it to move again, you will need to take it off of the Hold ROE.
-  **Advance at all Costs:** A team set to this Movement ROE will continue to advance along its path, whatever the costs. It will not stop moving to engage enemies, but will engage them while moving.

### **Combat ROEs**

A team's Combat ROE determines how often and carefully it fires.

-  **Recon:** A team on Recon will not open fire on any enemy it sees. It will return fire if fired upon, or engage enemies directly in its path. When possible, soldiers on Recon will use silenced weapons.
-  **Assault:** A team on Assault will carefully pick its shots. It will only fire if it can see an enemy, and will stop firing as soon as it no longer sees a threat.
-  **Suppress:** A team on Suppress will fire at any place it suspects an enemy to be. It will continue to fire at an area from which an enemy disappears for a few seconds.

## **SPLIT-SCREEN PLAY**

Split-Screen play allows two players to play either cooperatively, or against each other on the same Xbox. Player 1 always controls the top of the screen, and player 2 always controls the bottom of the screen. When SPLIT-SCREEN PLAY is first selected from the Main Menu, both players are taken to the controller selection

screen. Pressing up on the left thumbstick makes that controller player 1. Pushing down on the left thumbstick makes that controller player 2. When a controller has been assigned to a player, pressing left or right on the left thumbstick cycles through the available Dossiers for that player. The Dossier determines which controller setup is used for that player, as well as that player's name in the game. Pressing A Button locks in your selection of Dossier, and will change the color of your half of the screen. When your selection is locked in, just press the D pad to adjust your setup.

When both players have their selections locked in, they will be taken to the Session Setup Screen. From here, Player 1 can set the parameters for the game. Once the game is set up properly, player 1 selects PROCEED, and both players can configure their team.

Team Setup runs similarly to single-player Platoon Setup. No specialist characters will be available. Instead, the second column of characters is a female set. You will also notice that each class has many more kits available for selection. When you have set up your team the way you like it, click on the READY button, and you will be locked in to your selections. Once both players are locked in, the match will start.

## **LINK PLAY**

Two or more players can play against each other through Link Play, either connecting two Xbox Video Game Systems together using an Xbox System Link Cable, or by connecting multiple Xbox Video Game Systems together through an Ethernet Hub using standard Ethernet cables. Further information about hooking together Xbox Video Game Systems for Link Play games can be found in your Xbox Instruction Manual.

To start a Link Play game, select MULTIPLAYER from the Main Menu, and then select LINK PLAY. You will be taken to the Link Play Lobby. From here you can either create a new game by selecting an empty slot with CREATE GAME on it or you can join an existing game by selecting it. Games are identified by the name of the Dossier selected by the person who created the game.

If you have created a game, you can change the parameters of the game by selecting the EDIT SERVER button. If, at any time, you want to see the full parameters for the game, select the SERVER INFO button. Descriptions of each setting can be found below.



## Server Settings

- **Max Players:** This setting determines the maximum number of players that can join your game. Game type and network factors affect just how many players a game can safely support. If you experience frequent disconnection of clients in your game, try using a lower number of maximum players.
- **Threat Indicator:** This setting determines whether or not players will see their Threat Indicator when playing the game.
- **Time Limit:** The Time Limit determines the maximum length of a game.
- **Arcade Mode:** With Arcade Mode turned on, players will be faster and a little bit tougher. In addition, they will have unlimited ammunition for firearms. (However, some items, such as the AT4, will still have limited ammunition).
- **Map Rotation:** Using Map Rotation, you can specify a default order for automatically sequencing maps in between matches.
- **Map Repeats:** Using Map Repeats, you can specify the number of times you will play a map before the server automatically rotates to the next one.
- **Kit Restrictions:** Changing the Kit Restrictions limits the weapons that are available to the players.
- **IFF Mode:** The IFF mode will set different ways that you can tell friendlies from enemies. When it is set to Names, you will see the name of any player who is on your side floating above their head onscreen. When it is set to Reticle, the reticle will change color when it is sitting over a friendly player. When it is set to Off, you will need to rely on uniforms to tell people apart.
- **Voice Chat:** If players have voice peripheral attached to their system, they can communicate with each other through it using Voice Chat. The server setting controls who can and cannot talk during the game. When you are playing a team game, only the people on your side will hear your comments. When playing a solo game, everyone will hear you. When you are killed in-game, only other dead players can hear you, and you can hear only their comments.

## Game Settings

**Game:** Use this setting to determine the type of game you wish to play. Each game type is fully described below.

**Difficulty:** If the game type is set to co-op, you can select the difficulty for the mission.

**Random Zones:** If you are playing a team game type, you can turn on Random Zones to randomly pick the start location of each team.

**Random Teams:** If you are playing a team game type, Random Teams will randomly assign people to a side when the game starts up. When this is turned on, people will not be able to pick which team they are starting on.

**AI Backup:** If you are playing a team or co-op game type, you can set up each side to be completely filled out with AI soldiers that team leaders can control through the command map. If AI Backup is turned on, Respawnns cannot be turned on.

**Respawn Type:** If you want players to start over again when they die, you can turn on Respawnns. If the type is set to None, then when a player dies, they are out of the match. When it is set to Individual, everyone will get the specified number of respawns before they are out of the match. If it is set to Team, the entire team shares a pool of respawns. Once the team is out of respawns, anyone killed is removed from the match. If Respawn Type is set to infinite, no one will ever run out of respawns.

**Respawn Number:** If the Respawn Type is set to Team or Individual, you can specify the number of respawns used.

**Platoon Alliances:** You can have up to four platoons in the game on up to four teams. For co-op games, you can only have one platoon active. On solo games, Platoon Alliances are ignored because everyone is on their own side. For team games, you must have at least two different teams active, and each must contain at least one platoon. To change a platoon's alliance, highlight it and press the A Button. That platoon will change color. Platoons that are the same color are considered allies, and on the same team. If a platoon color is set to gray, that platoon is considered inactive, and players cannot select it during the team selection.

## Map Selection

Map Selection allows you to pick the map for the next match. The maps available for selection may vary depending on the game type you have selected, as not all maps are suitable for all game types. Map selection functions just like it selecting the level for a Quick Mission game.

## MULTIPLAYER GAME TYPES

There are several different game types you can play either with or against other players. Below is a description of each game type:



## Cooperative Games

Co-op games involve you working with other players toward a common goal and against the game itself. Co-op game types include:

- **Mission:** Playing a cooperative Mission game allows you and up to 5 friends to take on the mission just as it appears in the single-player campaign.
- **Firefight:** You and up to 5 friends take on enemies scattered throughout the level. The number of enemies depends on the difficulty you have set.
- **Recon:** You and up to 5 friends must make it through enemy territory to reach an extraction zone. The mission will end when all surviving team members make it into the extraction zone.

## Team Games

In Team games, you join up with other players in a team. Your team then opposes other teams of players in the game, as opposed to AI enemies. The Team game types are:

- **Last Man Standing:** The last team with people alive is the winner. If time runs out with multiple teams still on the map, the team with the most kills wins.
- **Search and Rescue:** There are three hostages in the center of the map. They will show up on your command map. The first team to bring all three hostages back to their starting base wins. Should time run out before the hostages are escorted safely, the team with more hostages returned than anyone else will win. To start escorting a hostage, simply run up to and touch them. They will then follow you.
- **Hamburger Hill:** There is a zone in the center of the map. If your team is the only one to have someone in that zone, you will get one point for every second that this is the case. At the end of the game, the team with the most points wins.
- **Domination:** There are five zones spread around the map. If someone from your team can get into the zone by themselves, the zone will change to your team's color. It will remain so until another team captures the zone. For every second that your team owns a zone, you will get a point. When the game ends, the team with the most points wins.
- **Siege:** The smallest team starts in a base that they have to defend. The other teams must get into the base. If an attacking team can get a team member into the base for five seconds, they win. If the defending team can hold the base until either time runs out or all attackers have been eliminated, they win.

Both Domination and Siege must be unlocked before you can play them.

## Solo Games

Solo games pit you against all of the other players, with no allies. The Solo game types are:

- **Last Man Standing:** The last person alive will win this mission. If time runs out first, the surviving person with the most kills wins.
- **Sharpshooter:** The person with the most kills (whether alive or dead) at the end of the mission wins.
- **Hamburger Hill:** This game functions just like the team game, except there is only one person on your team.
- **Cat and Mouse:** All players start as "cats." The first player to get a kill becomes the "mouse," and his kit is reduced to just a pistol. Anytime the mouse gets a kill, he gets a point. Any cat that kills the mouse becomes the mouse, while the former mouse respawns with his original kit. Kills recorded while you are a cat don't count toward your final score, and the player with the most points at the end is the winner.

Cat and Mouse must be unlocked before you can play Cat and Mouse games.

## XBOX LIVE PLAY

If you have signed up for an Xbox *Live* account, you can play either with or against other players over the Internet. Full information on connecting your Xbox Video Game System to a broadband modem can be found in the Xbox *Live* Connectivity section of this manual. If you do not yet have an Xbox *Live* account, you can sign up for one. Simply select MULTIPLAYER from the Main Menu. Then select PLAY LIVE! Select ACCOUNT SELECTION, and then select NEW ACCOUNT. This will allow you to sign up for an Xbox *Live* account.

If you already have an Xbox *Live* account, simply select PLAY LIVE! from the MULTIPLAYER selection on the Main Menu. You will then have several options, depending on whether you would like to join an existing game, or start up a new one.

## Quick Match

Use Quick Match if you have no real preferences, and just want to jump into a game. Select QUICK MATCH, and then select the type of game you want to play, either Cooperative, Solo, or Team. You will then get a list of eight games to choose from. Select one, and you will join that game session.



## Optimatch

If you choose Optimatch, you will be able to specify more preferences for the game you want than in Quick Match. The Max # of Players entry allows you to search for only games that allow up to that number of players in them. The Min Active players will filter out any game that has fewer than that number of players in it. If you choose to do a Friend Search, only games that have people from your Friends List in them will be displayed. When you have set the parameters, select the Search Button, and you will get a list of eight games. Select one, and you will join that game session. If none of the games looks appealing, press the B Button to return to the Search Screen, and try changing one or more parameters for your search.

## Create a Match

If you wish to start a game, you can select Create a Match. However, if you leave a game you have created, every player in the game will be forced out of it, and that whole game will end. You will need to set some parameters for the game. First, choose if you wish it to be a Cooperative, Solo, or Team game. You can then set the type of server you wish to run. If you set it to Public, anyone can join the game. If you set it to Private, only people you invite can join the game. Finally, you will need to set the maximum number of players you want in the game. Initially, Ghost Recon will check your connection and set a cap on this number, based upon your connection. You can lower this number, but you will not be able to raise it above this cap. Once you have started a game, you can set the server options. There are some minor changes in server options from a Link-Play game. In a team game, you may only have two platoons active. Also, the cap on the max number of players is adjusted based upon connection quality determined when you selected Create a Match. You may lower this number, but a maximum will be set for you.

## DEFAULT CONTROLLER SCHEME

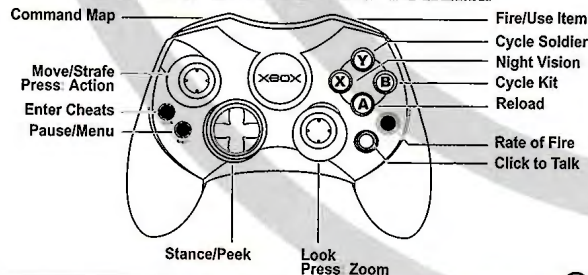

## CREDITS

Associate Producer  
Robbie Edwards

Lead Designer  
Gary Stelmack

Lead Engineer  
Clark Gibson

Lead Artist  
John Michel

Engineers  
Robert Hunt

Jon Owen

Curtis Smith

Jason Snyder

Diana Stelmack

Jeff Wesevich

Artists

Sloan Anderson

Jeremy Brown

Brian Reynolds

Demond Rogers

Dion Rogers

Ray Tylak

Character Team

Steve Wasaff

Joseph Drust

Chris Wells

Assistant Designers

Matthias Dohmen

Marketing Support

Heather Maxwell

Additional Engineering

Greg Stelmack

Quality Assurance Analysts

Paula Giordana

Dave LoSapio

Lead Testers

Christopher T. Curry

Prince Arrington

Testers

Mike Avinger

Lance E. Brown

Jamie Cardwell

Matt Jacobs

John M. Schuster

Ted V. Sewell

Jen Jahnke

Certification Testing

Jon Schweitzer

Additional Testing

Derek Earwood

Manual

Gary Stelmack

Richard Dansky

Red Storm Corporate

CEO

Yves Guillemot

President

Laurent Detoc

Vice President of Product

Development

Steve Reid

Vice President of Operations

Chris Olson

Director of Product

Development

Elizabeth Loverso

Director of Engineering

Todd Lewis

Director of Art

Jonathan Peedin

Director of Design

Frank Coker

Quality Control Manager

Jon Schweitzer

Quality Assurance Manager

Paula Giordana

Special Thanks

Ghost Recon and Desert Siege

Development Teams

## Ubi Soft Europe International Content Management

Editor in Chief

Serge Hascoet

Director of Production

Christine Burgess-Quemard

International Content

Manager

Travis Getz

Marketing

EMEA Marketing Director

Laurence Buisson-Nollent

EMEA Marketing Group

Manager

Laura Hatton

Axelle Verry

EMEA Brand Manager

Cedrick Delmas

Alexis Bodard

Local Brand Manager

Soren Lass

Marcel Keij

Doug McConkey

Stephane Catherine

Fabienne laurede

Ronald Kaulbach

Javier Montoro

Michael Gale

Valeria Iodeserto

Christian Born

Vanessa Leclercq

Evelyn de Voight

Special Thanks to:

Xavier Neal

Localization Project Manager

Anne Perreau

## Ubi Soft U.S.

U.S. Marketing

Helene Juguet

Sean McCann

Xavier Fouilleux

Public Relations

Tiffany Spencer

Creative Services

David Gene Oh

Alex Andrist

Special Thanks to:

Allen Adler

Jenna Dawson

Jen Groeling

Katrina Medema

Supervising Sound Designer

R. Dutch Hill

Composer

Bill Brown

Casting Director

Carole Ruggier

Sound Designer/Gun Recordist

Peter Zinda

Sound Designer

Bryan Celano

Sound Designer/Asset Manager

Glynnia Grimala

Dialogue Editor

Jed Dodge

Production Manager

Amanda Wyatt

Producer

Becky Allen

Weapons Provided By

Stembridge Gun Rental

Voice Talent

Carol Ruggier

Dublin James

Dato Bhaktadze

Wayne Duval

Michael Philip

Motion Capture provided by

Thanks to:

Joe Nolan

Keith Robinson

Bryon Wanderer

Chuck Mongelli

Motion Talent

Jim Illingworth

Chuck Artazone

John Flynne



## TECHNICAL SUPPORT

Before contacting Ubi Soft Entertainment's Technical Support Department, please first read through this manual. Also browse through our FAQ listings or search our support database at our website, <http://support.ubi.com>. Here you will find the most recently updated information since the game's release.

Whenever you contact the Technical Support Department, please include the following information or have it available if you are calling:

- Complete product title

### **Contact Us Over the Internet**

This is the best way to contact us. Our website is open 24 hours a day, 7 days a week, and it contains the most up-to-date Technical Support information. We update the Support pages on a daily basis, so please check here first for solutions to your problems: <http://support.ubi.com/>

### **Contact Us by Email**

For fastest response via email, please visit our website at <http://support.ubi.com/>

From this site, you will be able to enter the Ubi Soft Entertainment Solution Center where you can browse through our listings of Frequently Asked Questions (FAQ), search our database of known problems and solutions, or, for fastest email response, you can send in a request for Personal Assistance from a Technical Support Representative. It may take up to 72 hours for us to respond to your email depending upon the volume of messages we receive.

### **Contact Us by Phone**

You can also contact us by phone by calling (919) 460-9778. Note that this number is for technical assistance only. No hints or tips are given over the Technical Support line. When calling our Technical Support line, please make sure you have all of the necessary information listed above on hand. Be advised that our Technical Support Representatives are available to help you Monday-Friday from 9 am-9 pm (Eastern Standard Time).

While we do not charge for technical support, normal long-distance charges apply. To avoid long-distance charges, or to contact a support representative directly after these hours, please feel free to use one of the other support avenues listed above. Email issues usually receive a response within 2 business days.

### **Contact Us by Standard Mail**

If all else fails you can write to us at:

Ubi Soft Technical Support  
3200 Gateway Centre Blvd  
Suite 100  
Morrisville, NC 27560

### **Return Policy**

Please do not send any game returns directly to Ubi Soft Entertainment before contacting technical support. It is our policy that game returns must be dealt with by the retailer or online site where you purchased the product. If you have a damaged or faulty game, please visit our FAQ listing for your game and get the latest replacement policy and pricing. We will not accept unsolicited returns/exchanges without prior approval and an RMA (Return Materials Authorization) number from a support representative.

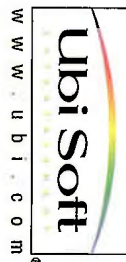
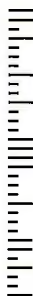

Leader Registrations Ubi Soft  
PO Box 67560  
Albuquerque, NM 87193

