

XBOX

LIVE™

ONLINE ENABLED

# CARVE



EVERYONE  
**E**  
CONTENT RATED BY  
ESRB

GS  
GLOBAL STAR  
SOFTWARE



## Safety Information

### About Photosensitive Seizures

A very small percentage of people may experience a seizure when exposed to certain visual images, including flashing lights or patterns that may appear in video games. Even people who have no history of seizures or epilepsy may have an undiagnosed condition that can cause these "photosensitive epileptic seizures" while watching video games.

These seizures may have a variety of symptoms including: lightheadedness, altered vision, eye or face twitching, jerking or shaking of arms or legs, disorientation, confusion, or momentary loss of awareness. Seizures may also cause loss of consciousness or convulsions that can lead to injury from falling down or striking nearby objects.

Immediately stop playing and consult a doctor if you experience any of these symptoms. Parents should watch for or ask their children about the above symptoms - children and teenagers are more likely than adults to experience these seizures.

The risk of photosensitive epileptic seizures may be reduced by sitting farther from the television screen, using a smaller television screen, playing in a well-lit room, and not playing when you are drowsy or fatigued.

If you or any of your relatives have a history of seizures or epilepsy, consult a doctor before playing.

**Other Important Health and Safety Information** The Xbox Instruction Manual contains important safety and health information that you should read and understand before using this software.

## Avoid Damage to Your Television

**Do not use with certain televisions.** Some televisions, especially front- or rear-projection types, can be damaged if any video games, including Xbox games, are played on them. Static images presented during the normal course of game play may "burn in" to the screen, causing a permanent shadow of the static image to appear at all times, even when video games are not being played. Similar damage may occur from static images created when placing a video game on hold or pause. Consult your television owner's manual to determine if video games can be played safely on your set. If you are unable to find this information in the owner's manual, contact your television dealer or the manufacturer to determine if video games can be played safely on your set.

Unauthorized copying, reverse engineering, transmission, public performance, rental, pay for play, or circumvention of copy protection is strictly prohibited.

# CONTENTS

Getting Started .....	Page 2
Game Controls .....	Page 3
Beginning the Game .....	Page 4
Game Modes .....	Page 5
On Screen Display .....	Page 6
How to Play Carve .....	Page 7-9
The Teams .....	Page 10
Tricks and Rush .....	Page 12-13
The Tricks .....	Page 13-15
Tournaments and Unlocking .....	Page 15-16
Xbox Live Connection Info .....	Page 17
Xbox Live and Carve .....	Page 18
Xbox Live Features .....	Page 19-21
Credits .....	Page 21-27



## GETTING STARTED

### USING THE XBOX™ VIDEO GAME SYSTEM

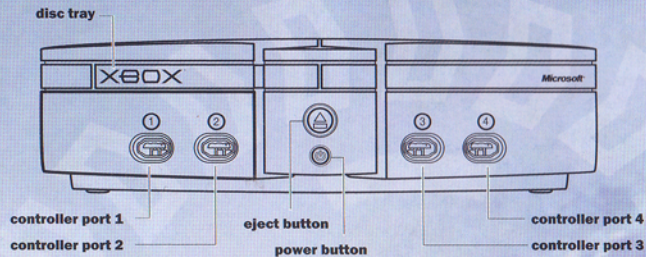

1. Set up your Xbox™ video game system from Microsoft by following the instructions in the Xbox Instruction Manual.
2. Press the power button and the status indicator light will light up.
3. Press the eject button and the disc tray will open.
4. Place the Carve disc on the disc tray with the label facing up and close the disc tray.
5. Follow all on-screen instructions and refer to this manual for more information about playing Carve.

## AVOIDING DAMAGE TO GAME DISC OR THE DISC DRIVE

To avoid damage to discs or the disc drive:

- Insert only Xbox-compatible discs into the disc drive.
- Never use oddly shaped discs, such as star-shaped or heart-shaped discs.
- Do not leave a disc in the Xbox console for extended periods when not in use.
- Do not move the Xbox console while the power is on and a disc is inserted.

The Save feature in Carve is designed to be used with the hard disk. It is not compatible with the Xbox Memory Unit (MU) (sold separately).

## GAME CONTROLS

1. Insert the Xbox Controller into any controller port on the Xbox console.  
For single player only.
2. Follow all on-screen instructions and refer to this instruction booklet for more information about using the Xbox Controller to play Carve.

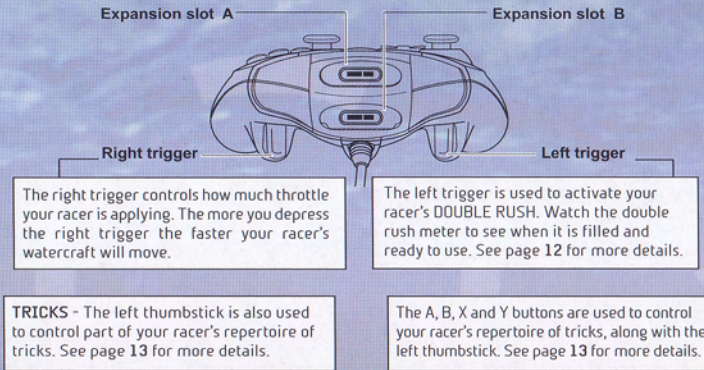

The right trigger controls how much throttle your racer is applying. The more you depress the right trigger the faster your racer's watercraft will move.

The left trigger is used to activate your racer's DOUBLE RUSH. Watch the double rush meter to see when it is filled and ready to use. See page 12 for more details.

**TRICKS** - The left thumbstick is also used to control part of your racer's repertoire of tricks. See page 13 for more details.

The A, B, X and Y buttons are used to control your racer's repertoire of tricks, along with the left thumbstick. See page 13 for more details.

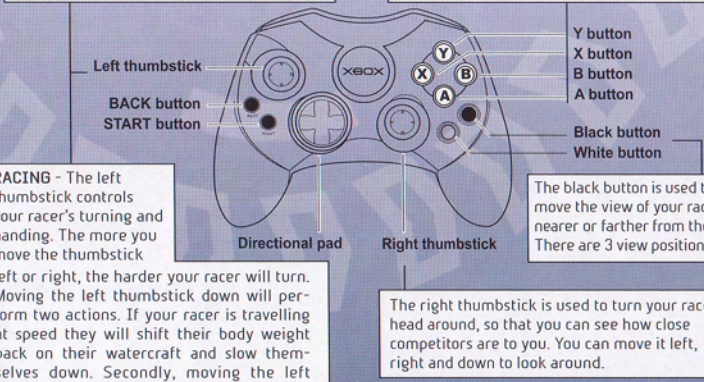

**RACING** - The left thumbstick controls your racer's turning and handing. The more you move the thumbstick left or right, the harder your racer will turn. Moving the left thumbstick down will perform two actions. If your racer is travelling at speed they will shift their body weight back on their watercraft and slow themselves down. Secondly, moving the left thumbstick right or left while holding it in the down position will enable your rider to perform tighter turns than usual.

The black button is used to move the view of your racer nearer or farther from them. There are 3 view positions.

The right thumbstick is used to turn your racer's head around, so that you can see how close competitors are to you. You can move it left, right and down to look around.



## BEGINNING THE GAME



Before you can begin your experience with Carve, you must create a player profile. Your profile will contain information about which tournaments, watercrafts, tricks, cheats and courses you have unlocked.

In order to replace one of the default profile names with your own simply move the directional pad or left thumbstick around the grid of letters. Use the A button to select or delete letters and to confirm the profile name once complete.

Carve supports up to five individual player profiles. Once these profiles have been created, you must use the Xbox dashboard to delete them.

## GAME MODES

Carve offers several gameplay modes, all of which are accessed from the Start Menu.

### QUICK RACE (ONEPLAYER)

An instant race feature, a random character and course are selected from those available in your selected profile.

### ARCADE (ONE-TO-FOURPLAYER)

Choose a character and course from those available. You can also define additional options, such as number of laps and weather type.

### TOURNAMENT (ONEPLAYER)

Play to unlock courses, tricks, tournaments, watercraft and cheats (See page 15 for more details).

### TRICK TUTORIAL

Learn how to combo tricks and earn points, but more importantly, RUSH! (speed boost).

### SYSTEM LINK (UP TO EIGHTPLAYER)

Connect up to eight Xbox systems together for a multiplayer Carve experience.

### XBOX LIVE (UP TO EIGHTPLAYER)

Connect to Xbox Live to play Carve online (See page 18 for more details).



## TIME TRIAL (ONEPLAYER)

Improve your lap times and challenge yourself on all available courses.

## OPTIONS AND EXTRAS

View replays and best lap times, and set general game options.

## ON SCREEN

### TRICK SCORE

Shows your overall trick score for the race.

### LAP INDICATOR

Shows how many laps are remaining from the total.

### GAME TIMER

Counts-down the remaining time for completing each lap of the race. Your best lap is also displayed.

### POSITION INDICATOR

Indicates your position relative to the field.

### BUOY LOCK-ON

This lock-on system indicates which buoy is the next on the course. The arrows around the buoy lock-on's edge depict how large the turn will be around the buoy when you reach it. If you are facing too far away from the next buoy, the lock-on will float in the middle of the screen and arrows will appear to indicate which way to turn to reattach the lock-on to the buoy.

### DOUBLE RUSH METER

Displays how many units you have collected toward a "DOUBLE RUSH". Once the meter is full, it will start flashing, indicating it is ready to be activated. (See page 12 for more details)

### RUSH METER

The RUSH! meter only appears when you perform tricks. The RUSH! meter consists of five segments that are filled as you perform tricks to each of the five RUSH! stages (see page 16 for more details).

### BUOY MISSES

Shows how many buoys you can miss in the current race. See page 7 for more details.

### TEAM INTERCOM

Your team-mate uses the two-way communication system to give you information with regarding the race. A communication box will appear on-screen when in use.

### SPEED & REV COUNTER

Show how fast your watercraft is moving, and how high the engine is revving.



### TEAM AND RIVAL INDICATORS

These appear and move along the lower part of the screen display to indicate where other racers are. Your team-mate is indicated by a red arrow. These indicators will fade out the further they are from you.

## HOW TO PLAY CARVE

Here's an insider tip on how to get the optimum results from your Carve experience, but more important....how to win.

### BUOYS

Buoys mark out the course in which you have to follow. Just remember, the red buoys have to be passed on the right-hand side and yellow buoys have to be passed on the left-hand side. It's as simple as that and the buoy lock-on system will help you guide your watercraft through the right route around the buoys.

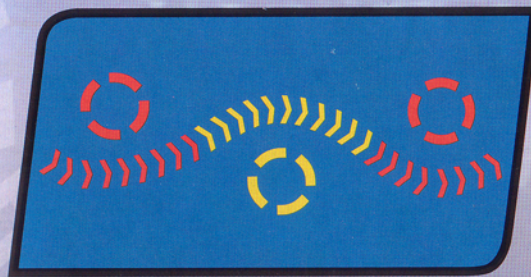

### BUOY MISSES

During a race, you can miss up to four buoys from the course and still keep racing. However, if you miss the fifth buoy, you will be disqualified from the race - so keep count! Your buoy misses are indicated in the top right corner of the screen.



## SHORTCUTS

While it's usually best to pass buoys on the marked sides, if need be, you can tactically miss up to four buoys in order to achieve the quickest routes around the course and to beat your opponents to the finish line. The diagram above shows a buoy miss, the 'assigned' route is around the left-hand side of the yellow buoy, however, by going to the right-hand



side of the yellow buoy, you can take advantage of a short cut which will help you win the race. Keep an eye out for buoy miss opportunities; shortcuts can lead to extra ramps and new areas of the course. Also, keep in mind that the most advantageous shortcuts will require you to miss more than one buoy at a time.

## MORE ABOUT PLAYING CARVE

Buoys and shortcuts are only part of the equation that make up Carve.

### WATCH OUT FOR WAKES!

Just as in real watercraft racing, in Carve the water trails (wakes) left behind by other racer's watercraft are highly turbulent. If you ride too

close behind other racers, your own watercraft will be slowed down. To avoid getting bogged down by other racers' wakes, direct your watercraft away from the watercrafts that are in front of you. Running into a wake can have devastating effect on the outcome of the race.

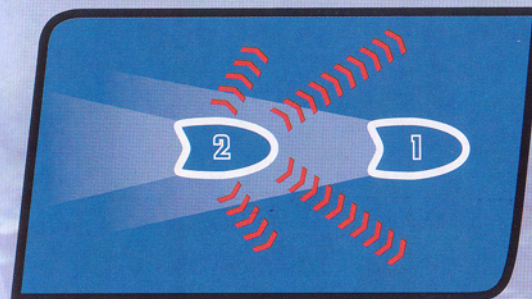

## IT'S ALL ABOUT TEAMS

You're not alone out there on the water battling against other racers. Every racer is paired with a formidable weapon...their team-mate. Your team-mate can assist you in two ways: They keep you abreast of your status in the race via the team intercom system, and your team-mate



may even ram or block an opponent to better your chances of winning the race. However, it's worth noting that team dynamics has its strengths and weaknesses that provide different advantages at various stages of a race.



## THE TEAMS

### TEAM VENTA

They might be a little slower while racing but do a trick and their RUSH! is unbeatable.

#### MOKE (LEFT)

A surfer dude who lives for thrills on the waves.

#### OZ (RIGHT)

Cool, calm and collected, Oz is Moke's saving grace.



### TEAM TSUNAMI

Only sharp racing lines and shortcuts will do! They have the fastest speed while racing but their RUSH! is slowest of all.

#### MIZUKI (LEFT)

Crazy Mizuki rides the waves with pure passion and drive.

#### AMIKO (RIGHT)

The older of the Tsunami sisters and a major force in the race



### TEAM INFERNO

Hard as nails and real rough riders; Inferno takes no prisoners. Average racers but good RUSH! speed – and nasty tempers.

#### ADRIENNE (LEFT)

Razor-sharp Adrienne can't hide her soft-spot for Max.

#### MAX (RIGHT)

A playboy con-man with a love for all things dangerous.



### TEAM TERRA

Ex-Soviet Bloc riders who love to do just that – block! Watch their wakes to avoid being slowed. Average race and RUSH! speed.

#### ELENA (LEFT)

Twisting and turning is her skill but Nikolai rules her heart.

#### NIKOLAI (RIGHT)

Oldest of all the Carve riders but that only makes Nikolai stronger.





# TRICKS AND RUSH

In order to rip through the courses in Carve, you must perform tricks successfully. A trick is deemed successful when it is landed crash free. When a trick is landed without a wipe out, you are rewarded with an adrenaline RUSH! (speed boost). The bigger the trick you perform, the bigger the RUSH! you'll receive.

## RUSH! STAGES AND COMBOS



RUSH! is rewarded in five stages, which are represented on-screen by the R.U.S.H.! meter which fills up with color when tricks are successfully pulled off. The fastest way to fill the RUSH! meter is to link tricks together as combinations. You may want to familiarize yourself with trick combinations via Carve's Trick Tutorial option (accessed from the Start Menu).

## DOUBLE RUSH

Each time you achieve RUSH!, color bars or points are added to the DOUBLE RUSH meter, located on the lower left side of the screen. Once this meter is filled, it will start to flash, indicating that it's ready to be activated. To activate, simply pull the left trigger on the Xbox Controller and

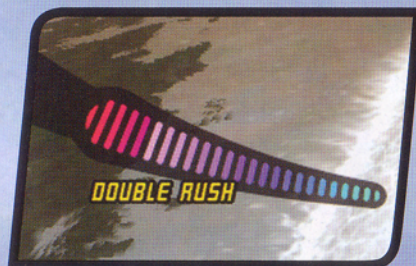

you will achieve DOUBLE RUSH (the ultimate speed boost), so get ready for some serious speed! However, if you crash and get knocked off your watercraft, points will be deducted off the DOUBLE RUSH meter.

## SIGNATURE TRICKS

Each racer has four 'signature tricks' that deliver powerful instant-hits of RUSH! The most powerful signature trick will give you a stage five RUSH! in a single trick! However, these tricks must first be unlocked in the tournament mode (See page 15 for more details on unlocking signature tricks).

# THE TRICKS

The following is a list of the core button and thumbstick moves required to activate the tricks in Carve. Tricks are classified into two categories: those that can be performed from ramps and those performed on water. The button presses for the signature tricks are revealed on the in-game pause menu once they are unlocked. To view the full list of trick controls in mid-race, simply press pause (start button) and scroll down to the appropriate section.

### BACKFLIP: ramp trick

Move the thumbstick forward as the watercraft hits a ramp then move quickly down as it leaves the ramp's edge.





**BARREL ROLL: ramp trick**

Move the thumbstick left or right as the watercraft hits a ramp then move quickly in the opposite direction as it leaves the ramp's edge.

← or →, Opposite Direction

**SUBMARINE: ramp trick**

Jump from the ramp or finish a previous ramp trick and move the thumbstick forward to dive into the water.

↑

**ONE HANDER: ramp trick**

Jump from the ramp and press the X or Y twice. Hold the second press in order to extend the trick.

X or Y (x2)

**INDIAN AIR: ramp trick**

Jump from the ramp and press the A or B twice. Hold the second press in order to extend the trick.

A or B (x2)

**AIR WALK: ramp trick**

Jump from the ramp and press A, B, B. Hold the last press in order to extend the trick.

A, B, B

**SUPERMAN: ramp trick**

Jump from the ramp and press A, B, A, B. Hold the last press in order to extend the trick.

A, B, A, B

**NOTHING: ramp trick**

Jump from the ramp and press X, B, Y.

X, B, Y

**HANDSTAND: water trick**

While moving on the water press X, Y, X, Y. Hold the last press in order to extend the trick.

X, Y, X, Y

**BODYWHIP: water trick**

While moving on the water press X, Y, B, A for one direction or B, Y, X, A for the other.

X, Y, B, A or B, Y, X, A

**SURFER: water trick**

While moving on the water move up on the left thumbstick and press Y, X. Hold the last press in order to extend the trick.

←, Y, X

**REVERSAL: water trick**

While moving on the water press X, A, X, A. Hold the last press in order to extend the trick. Beware – the reversal also reverses your steering controls!

X, A, X, A

## TOURNAMENTS: THE KEY TO UNLOCKING

When you first create a player profile in Carve, only a few of the game's areas are made available. However, by completing the five tournaments and hitting other goals along the way, you can unlock massive amounts of extra gameplay. Unlocking additional courses and watercrafts are automatically done once you've completed each tournament. To unlock additional signature tricks, you have to complete the trick point goal for the each tournament. This goal is displayed on-screen before the start of each tournament. To unlock the cheats, you must place first in each tournament.



UNLOCK TOURNAMENT	COURSES	CRAFT	TRICK	CHEAT
<b>ROOKIE</b>				
<b>ADVANCED 1</b>				
<b>ADVANCED 2</b>				
<b>PRO 1</b>				
<b>PRO 2</b>				

## COURSES

Each of Carve's four major locales (Arctic, Europe, Pacific and USA) contains six courses. If you go to the arcade mode course select screen you can navigate through them. Before tackling the tournaments only two of these 24 main courses are available. By the end of the fifth tournament (Pro Series 2) all 24 courses will be available. There are three other courses to unlock... but we'll leave it for you to discover how.

## ARCADE MODE AND TRICK RANK

Once each course is unlocked in the tournament mode, you can then play it either single or multiplayer in arcade mode. If attempted in one player, the course 'trick rank' can be set - do the biggest ramp tricks and the longest water tricks in order to collect the ultimate 'S' rank for each course.

## XBOX™ LIVE

Xbox™ Live is a high-speed internet gaming community where you can create a permanent gamer identity, set up a friends list to see who's online, and invite them to play, and talk to them in real time. To determine if Xbox live is available in your region, go to <http://www.xbox.com/live>. Before you can play Carve online, you need to connect your Xbox console to a direct or shared broadband connection and sign up for the Xbox Live service. For details, see <http://www.xbox.com/live> or call 1-800-4MY-XBOX. You can also reference <http://www.take2games.com/support> for information.

## XBOX LIVE CONNECTION INFORMATION

Important! Before using this product, read the Xbox Instruction Manual for important safety information and health warnings.

### Step 1: Connect

To connect your Xbox console directly to broadband, see diagram A. Or, to share your broadband connection with a PC, see diagram B. For more details and other home networking options, including Internet connection sharing, see [www.xbox.com/live](http://www.xbox.com/live).

#### A. Direct Connection

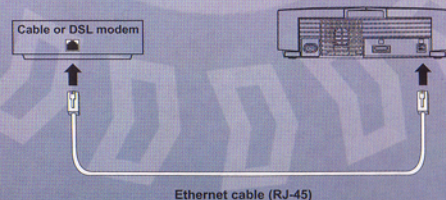



## B. Shared Connection

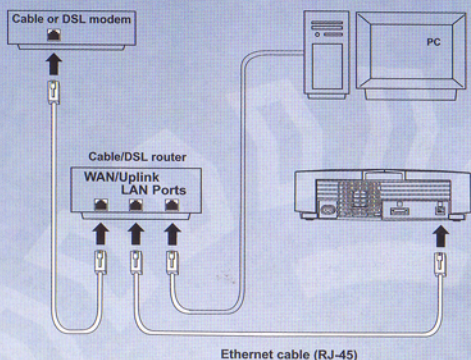

# XBOX™ LIVE AND CARVE

Up to eight players can join a Carve game session on Xbox Live. The session host can specify a wide range of options for that session (the session host is the player who is hosting the game-in-play on their Xbox System).

## XBOX™ LIVE MAIN MENU

Once you have successfully connected to Xbox Live from Carve's start menu, you have the option of searching for a game session. Optimatch allows you to search for specific types of game, while quick match simply lists all the available game sessions. General Options allows you to manage Xbox Live friends and recent



players via adding, removing and giving feedback. The General Options menu allows you to add, remove and leave feedback on recent players. Remember to play fair and be polite at all times!

## GAME TYPES AND OPTIONS

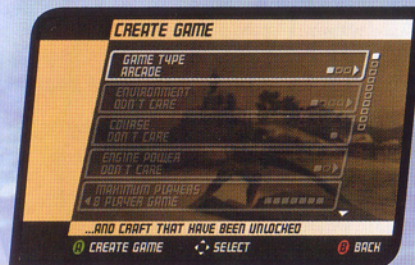

When you create a game session for others to join, the two main game modes are arcade and team play.

## ARCADE MODE

As with the non-Xbox Live arcade mode, you can race up to eight players. The number of laps and buoy misses can be set, along with the course to be played and how fast the watercraft will be.

## TEAMPLAY MODE

This mode allows players to pair-up and take control of the sets of two racers who form each of Carve's four teams. While in team play mode you and your teammate will have combined team points when the race is finished. Beware - you also share buoy misses while in teamplay mode, so keep an eye on where you are heading!

Carve contains several additional features designed to enhance your experience while playing the game via Xbox Live. If you are in the game lobby and are waiting for a race-in-progress to end, you can view the positions of the other player's racers on the course map.



Via the in-game menus you can also...

- Automatically invite friends to join your game session from either Carve or other Xbox titles.
- Receive automatic notification that friends have started Xbox Live.
- Reserve game sessions slots for friends to join. Change the display options to show either all player names while racing, or just the one ahead, or none.
- Allow other player's best laps from Xbox Live sessions to be entered into your own profile.
- Create dedicated chatrooms within Carve so that others can race while you talk.

## ONLINE RANKINGS

Carve supports online ranking boards for both racing (skill) and trick points. These are accessed via the main Xbox Live menu, and are restarted at the beginning of each month. Boards from the past two and current months can be accessed from the menu options.

## RANKING OPTIONS

As well as viewing the last three months of rankings, you can sort the list by all players, just those on your friends list, or by those on your recent player list.

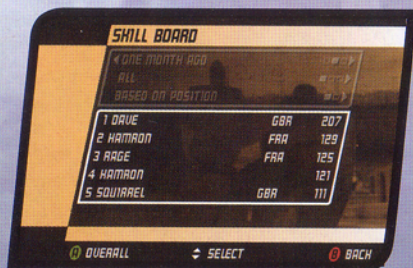

## SKILL BOARD SCORING SYSTEM

After completing an Xbox Live race you are awarded points for a variety of criteria. The most important to notice is that you earn more points for beating those players who are ranked higher than you, compared to those who are ranked lower. If you're a good racer the only way to keep earning lots of points is to keep getting better – there's no point picking on new players!

## TECHNICAL SUPPORT

Technical Support for Global Star products is available via the internet at <http://www.take2games.com/support> or email at [tech@globalstarsoftware.com](mailto:tech@globalstarsoftware.com).

## CARVE CREDITS

### TAKE 2 INTERACTIVE NYC

Associate Producer: James Pacquing  
Chief Technology Officer: Gary J Foreman  
Director of Quality Assurance: Jeff Rosa

Production Team: Terry Donovan, Susan Lewis, Jamie King, David Nottingham, Jenefer Gross, Greg Ryan, Tim Sweeney, David Kim, Mike Cala, Tony King, Dan Lish, Jennifer Kolbe, Daniel Einzig, Kristine Severson, Marc Nesbitt, Gregg Sanderson, Peggy Yu

### LINCOLN QA TEAM

QA Manager: Mark Lloyd  
Lead Product Analyst: Lee Johnson



**Product Analyst Team:** Craig Reeve, Mike Emeny, Jono Stones, Matt Hewitt, Vicky Hemming, Ollie Waind, Tim Bates, Matthew Lunnon, Phil Alexander

## SOUNDTRACK / MUSIC CREDITS

### **FUNK D'VOID**

*"Bad Coffee"*

(written by Lars Sandberg)

Funk D'Void appear courtesy of Soma Recordings Ltd.

Published by SPG Publishing UK Ltd.

Copyright 1997

For more information on Soma artists, check out

[www.somarecords.com](http://www.somarecords.com)

### **FUNK D'VOID**

*"The Light"*

(written by Lars Sandberg)

Funk D'Void appear courtesy of Soma Recordings Ltd.

Published by SPG Publishing UK Ltd.

Copyright 1997

For more information on Soma artists, check out

[www.somarecords.com](http://www.somarecords.com)

### **MFON**

*"Rubberlegs (studio 54 Remix)"*

(written by Mfon Akpan)

Mfon appear courtesy of Soma Recordings Ltd.

Published by SPG Publishing UK Ltd.

Copyright 1999

For more information on Soma artists, check out

[www.somarecords.com](http://www.somarecords.com)

# CARVE

### **PERCY X**

*"Afterplan"*

(written by Tony Scott)

Percy X appear courtesy of Soma Recordings Ltd.

Published by SPG Publishing UK Ltd.

Copyright 2002

For more information on Soma artists, check out [www.somarecords.com](http://www.somarecords.com)

### **PERCY X**

*"Inbox"*

(written by Tony Scott)

Percy X appear courtesy of Soma Recordings Ltd.

Published by SPG Publishing UK Ltd.

Copyright 2002

For more information on Soma artists, check out [www.somarecords.com](http://www.somarecords.com)

### **FUNK D'VOID**

*"Diabla (Samuel L Sessions Remix)"*

(written by Lars Sandberg)

Funk D'Void appear courtesy of Soma Recordings Ltd.

Published by SPG Publishing UK Ltd.

Copyright 2001

For more information on Soma artists, check out [www.somarecords.com](http://www.somarecords.com)

### **PERCY X**

*"Maintain"*

(written by Tony Scott)

Percy X appear courtesy of Soma Recordings Ltd.

Published by SPG Publishing UK Ltd.

Copyright 2001

For more information on Soma artists, check out [www.somarecords.com](http://www.somarecords.com)



**PERCY X**

*"Track 2"*

(written by Tony Scott)

Percy X appear courtesy of Soma Recordings Ltd.

Published by SPG Publishing UK Ltd.

Copyright 1998

For more information on Soma artists, check out [www.somarecords.com](http://www.somarecords.com)

**PERCY X**

*"Club X"*

(written by Tony Scott)

Percy X appear courtesy of Soma Recordings Ltd.

Published by SPG Publishing UK Ltd.

Copyright 2002

For more information on Soma artists, check out [www.somarecords.com](http://www.somarecords.com)

**SLAM**

*"Narco Tourist (UNKLE Remix)"*

(written by McMillan/Meikle, File/Lavelle)

Slam appear courtesy of Soma Recordings Ltd.

Published by SPG Publishing UK Ltd., Copyright Control

Copyright 2001

For more information on Soma artists, check out [www.somarecords.com](http://www.somarecords.com)

**SLAM**

*"Dark Forces"*

(written by McMillan/Meikle)

Slam appear courtesy of Soma Recordings Ltd.

Published by SPG Publishing UK Ltd.

Copyright 1996

For more information on Soma artists, check out [www.somarecords.com](http://www.somarecords.com)

**SLAM**

*"Positive Education"*

(written by McMillan/Meikle)

Slam appear courtesy of Soma Recordings Ltd.

Published by SPG Publishing UK Ltd.

Copyright 1993

For more information on Soma artists, check out [www.somarecords.com](http://www.somarecords.com)

**SLAM**

*"Stepback (Christian Smith and Selway Remix)"*

(written by McMillan/Meikle/Muotune)

Slam appear courtesy of Soma Recordings Ltd.

Published by SPG Publishing UK Ltd., Copyright Control

Copyright 2002

For more information on Soma artists, check out [www.somarecords.com](http://www.somarecords.com)

**RNG (RANDOM NOISE GENERATOR)**

*"Roof Raiser"*

(written by Lorne Burden, Leonard Burden, Lawrence Burden)

RNG appear courtesy of 430 West Records

Published by Munchman Music.

Copyright 2003

For more information on 430 West artists, check out [www.430west.com](http://www.430west.com)

**RNG (RANDOM NOISE GENERATOR)**

*"A Better Tomorrow"*

(written by Lynell Burden, Leonard Burden, Lawrence Burden)

RNG appear courtesy of 430 West Records

Published by Munchman Music.

Copyright 2003

For more information on 430 West artists, check out [www.430west.com](http://www.430west.com)



## **RADIO 4**

*"New Disco"*

(written by Radio 4)

Radio 4 appear courtesy of Gern Blandsten

Published by Radio 4

Copyright 2002

For more information on Gern Blandsten artists, check out [www.gernblandsten.com](http://www.gernblandsten.com)

## **RADIO 4**

*"Our Town"*

(written by Radio 4)

Radio 4 appear courtesy of Gern Blandsten

Published by Radio 4

Copyright 2002

For more information on Gern Blandsten artists, check out [www.gernblandsten.com](http://www.gernblandsten.com)

## **POET NAME LIFE**

*"You Want Battle"*

(written by Poet Name Life)

Poet Name Life appear courtesy of Listen Deep Music

Published by Listen Deep Music (BMI)

Copyright 2003

## **LEGOWELT**

*"Disco Rout"*

(written by Legowelt)

Legowelt appear courtesy of Ghostly International

Published by Ghostly International

Copyright 2002

For more information on Ghostly International artists, check out [www.ghostly.com](http://www.ghostly.com)

## **JACK ASS & MULE**

*"1-2-3 Miami (Selway Rapture! Remix)"*

(written by Chris Brann for Wamdue Productions. Produced by Chris Brann with Tommie Sunshine. Remix and additional production by John Selway)

Jack Ass & Mule appear courtesy of Xylophone Jones Recordings / Dust Traxx, Inc. Published by Wamdue Music (ASCAP).

Copyright 2002. For more information on Dust Traxx artists, check out [www.dustraxx.com](http://www.dustraxx.com)

## **ORION & MATH**

*"Desolate Plains"*

(written by Orion & Math. Produced by Orion)

Orion & Math. appear courtesy of Breakbeat Science Recordings, LLC.

Published by Breakbeat Science Recording, LLC

Copyright 2002

For more information on Breakbeat Science artists, check out [www.breakbeatsscience.com](http://www.breakbeatsscience.com)

## **ZERO ZERO**

*"True Zero"*

(written by Zero Zero)

Zero Zero appear courtesy of Jade Tree

Published by Miss TK, Aristocats, Bim Bam Bap

Copyright 2002

For more information on Jade Tree artists, check out [www.jadetree.com](http://www.jadetree.com)

## **THE VOICES**

*"Sure Thing"*

(words by John Saxon. Music by John Saxon & Steve Yanko. Arranged by John Saxon & Steve Yanko. Produced, Mixed, Engineered by Steve Yanko)

Published by Pete Miniaci, Steve Yanko

Copyright 2003





# RACING 2



## AVAILABLE NOW



©2003 Global Star Software and the Global Star Software logo are trademarks of Take-Two Interactive Software, Inc. ©2003 Take-Two Interactive Software, Inc. All rights reserved. The ratings icon is a trademark of the Entertainment Software Association. Ford Racing 2 interactive game ©2003 Empire Interactive Europe Ltd. Ford Racing and nameplates are registered trademarks owned and licensed by Ford Motor Company, Empire and "©" are either trademarks or registered trademarks of Empire Interactive Europe Ltd. in the UK/US and/or other countries. All rights reserved. Dolby and the double-D symbol are trademarks of Dolby Laboratories. Microsoft, Xbox, Xbox Live, the Live Logos and the Xbox Logos are registered trademarks or trademarks of Microsoft Corporation in the United States and/or other countries.

# CARVE

## WARRANTY

GLOBAL STAR SOFTWARE, A DIVISION OF TAKE-TWO INTERACTIVE SOFTWARE, INC., WARRANTS TO THE PURCHASER ONLY THAT THE DISC PROVIDED WITH THIS MANUAL AND THE SOFTWARE PROGRAM CODED ON IT WILL PERFORM IN ACCORDANCE WITH THE DESCRIPTION IN THIS MANUAL WHEN USED WITH THE SPECIFIED EQUIPMENT, FOR A PERIOD OF 90 DAYS FROM THE DATE OF PURCHASE.

IF THIS PROGRAM IS FOUND TO BE DEFECTIVE WITHIN 90 DAYS OF PURCHASE, IT WILL BE REPLACED. SIMPLY RETURN THE DISC TO GOTHAM GAMES OR ITS AUTHORIZED DEALER ALONG WITH A DATED PROOF OF PURCHASE. REPLACEMENT OF THE DISC, FREE OF CHARGE TO THE ORIGINAL PURCHASER (EXCEPT FOR THE COST OF RETURNING THE DISC) IS THE FULL EXTENT OF OUR LIABILITY.

THIS WARRANTY IS IN LIEU OF ALL OTHER WARRANTIES, WHETHER ORAL OR WRITTEN, EXPRESSED OR IMPLIED. ALL IMPLIED WARRANTIES, INCLUDING THOSE OF MERCHANTABILITY AND FITNESS FOR A PARTICULAR PURPOSE, IF APPLICABLE ARE LIMITED IN DURATION TO 90 DAYS FROM THE DATE OF PURCHASE OF THIS PRODUCT.

GLOBAL STAR SOFTWARE SHALL NOT BE LIABLE FOR INCIDENTAL AND/OR CONSEQUENTIAL DAMAGES FOR THE BREACH OF ANY EXPRESS OR IMPLIED WARRANTY INCLUDING DAMAGE TO PROPERTY AND, TO THE EXTENT PERMITTED BY THE LAW, DAMAGES FOR PERSONAL INJURY, EVEN IF GOTHAM GAMES HAS BEEN ADVISED OF THE POSSIBILITY OF SUCH DAMAGES. SOME STATES DO NOT ALLOW THE EXCLUSION OR LIMITATION OF ANY INCIDENTAL OR CONSEQUENTIAL DAMAGES OR LIMITATIONS ON HOW LONG AN IMPLIED WARRANTY LASTS, SO THE ABOVE LIMITATIONS OR EXCLUSIONS MAY NOT APPLY TO YOU.

THIS WARRANTY SHALL NOT BE APPLICABLE TO THE EXTENT THAT ANY PROVISION OF THIS WARRANTY IS PROHIBITED BY ANY FEDERAL, STATE, OR MUNICIPAL LAW, WHICH CANNOT BE PREEMPTED. THIS WARRANTY GIVES YOU SPECIFIC LEGAL RIGHTS AND YOU MAY ALSO HAVE OTHER RIGHTS, WHICH MAY VARY FROM STATE TO STATE.

YOU MAY NOT REPRODUCE, PREPARE DERIVATIVE WORKS BASED ON, DISTRIBUTE COPIES OF, OFFER FOR SALE, SELL, TRANSFER OWNERSHIP OF, RENT, LEASE, OR LEND TO OTHERS THE PROGRAM OR ACCOMPANYING DOCUMENTATION, OR ANY PORTION OR COMPONENT OF THE PROGRAM OR ACCOMPANYING DOCUMENTATION; PROVIDED, HOWEVER, THAT YOU MAY TRANSFER THE ENTIRE PROGRAM AND ACCOMPANYING DOCUMENTATION ON A PERMANENT BASIS AS LONG AS YOU RETAIN NO COPIES (INCLUDING ARCHIVAL OR BACKUP COPIES) OF THE PROGRAM, ACCOMPANYING DOCUMENTATION, OR ANY PORTION OR COMPONENT OF THE PROGRAM OR ACCOMPANYING DOCUMENTATION, AND THE RECIPIENT AGREES TO THE TERMS OF THE AGREEMENT. FURTHER, YOU MAY NOT MODIFY, REVERSE ENGINEER, DISASSEMBLE, DECOMPILER OR TRANSLATE THE PROGRAM OR ACCOMPANYING DOCUMENTATION, OR ANY PORTION OR COMPONENT OF THE PROGRAM OR ACCOMPANYING DOCUMENTATION, NOR MAY YOU MAKE ANY COPIES OF THE PROGRAM MODULES FOR USE WITH OTHER PROGRAMS. THIS PROGRAM IS INTENDED FOR PRIVATE USE ONLY.

GLOBAL STAR SOFTWARE  
622 BROADWAY 5TH FLOOR  
NEW YORK, NY 10012

### ESRB RATING

THIS PRODUCT HAS BEEN RATED BY THE ENTERTAINMENT SOFTWARE RATINGS BOARD. FOR INFORMATION ABOUT THE ESRB RATING, OR TO COMMENT ABOUT THE APPROPRIATENESS OF THE RATING, PLEASE CONTACT THE ESRB AT 1-800-771-3772.





Microsoft, Xbox, Xbox Live, the Live logo and the Xbox Logos are registered trademarks or trademarks of Microsoft Corporation in the U.S. and/or other countries and are used under license from Microsoft. The ratings icon is a trademark of the Entertainment Software Association. Global Star Software, Inc. is a wholly owned subsidiary of Take-Two Interactive Software, Inc. Global Star Software and the Global Star Software logo are trademarks of Take-Two Interactive Software, Inc. ALL RIGHTS RESERVED.