

# ORBITER

Version 2.0

Disregard Section 2, Getting Started (pages 7-13) in the manual. Use the following instructions instead.

## System Requirements

- An IBM PC, PCjr, XT, AT or compatible
- 256K RAM with DOS 2.0 or 2.1; 320K RAM with DOS 3.0 or higher
- One 5.25" floppy drive or one 3.5" floppy drive
- CGA (color graphics card)
- RGB color monitor
- A mouse is optional

## Making a Backup Copy of the ORBITER Disk

Make a backup copy of the ORBITER disk, and use the backup copy for everyday operation. Follow the normal conventions for copying disks, but make sure your original disk is write-protected before you make the backup, so you don't accidentally erase the original.

## Copying ORBITER onto a Hard Disk

To run ORBITER from a hard disk, create a directory called "Orbiter," and copy all the files from the ORBITER disk into that directory.

## Using a Mouse

If you're going to use a mouse, make sure the mouse "driver" software is loaded into memory before you load ORBITER.

## Loading the Program

Turn on your computer and proceed to a DOS prompt. If you're loading ORBITER from a hard drive, change to the appropriate directory. If you're loading from a floppy drive, insert your ORBITER backup disk into the drive. Then switch to that drive (e.g., type *A:*), if you haven't already done so. At the DOS prompt, type *ORBITER* (and press **Return**).

## Quitting ORBITER

To quit, you must **be in the** CRT screen. (Press the **Spacebar** or **ESC** key to toggle between the Panels and the CRT's.) Select the File menu by using the left or right arrow until File is highlighted, then use the down arrow to pull down the menu. Press the down arrow again until **Quit** is highlighted. Press **Return** or **Enter** to process your selection. Select [0] (for OK) when asked if you're sure you want to quit.

## Pages 18, 70, and 71: GPC Commands

Commands for the onboard computers must be typed in a certain format (e.g., [I 39 E]). You must switch to the CRT screen by pressing **Spacebar** or the **ESC** key in order to enter these GPC commands.

## Page 27: Adjusting the Angle of Attack (AA)

If the angle of attack does not decrease to between 10 to 12 degrees while you are using a pitch rotation, stop the pitch and start a yaw rotation to the right or left until the AA reaches the desired number.

## Page 31: Saving Games

ORBITER now needs only 15K disk space to save one game.

## Page 32: File Menu-Play Guided Tour

This option is no longer available on the program disk. An ORBITER demo disk is available to dealers.

## Use of Additional RAM

If your system has more than 384K RAM, ORBITER will use that additional memory to speed up the display of graphics.

**Spectrum HoloByte™**

2061 Challenger Drive  
Alameda, CA 94501  
(415)522-3584

Customer Support  
(415)522-1164

## FUNCTION KEYS

### Panels

F1 - Left Display

F3 - Control

F5 - Landing

F7 - Engines

F9 - RMS (Arm)

F2 - Right Display

F4 - Digital Pilot

F6 - Payload Bay

F8 - Weapons

F10 - Aft or Forward Window

### CRT's

F1 - Radio Log

F3 - Launch/Payload/Landing

F5 - Landing Display

F2 - Messages

F4 - Orbital Display

## KEYBOARD EQUIVALENTS

◇ = Alt key

◇ S = Suspend Game

◇ Q = Continue Game

◇ K = Switch to km or meters

◇ A = Affirmative

◇ N = Negative

◇ M = View Current Mission

◇ 1 = Forward View

◇ 2 = Aft View

◇ 3 = Map View

◇ 4 = MMU View

◇ 5 = Low Orbital

◇ 6 = High Orbital

## QUICK REFERENCE CARD

		Altitude <input type="text" value="0"/>	B Abort <input type="text" value="0"/>	APU Fuel L ▲ C ▲ R ▲	Fuel Cell L ▲ C ▲ R ▲	React H2 <input type="text" value="0"/>
Helium L ▲ C ▲ R ▲		Engines L ▲ C ▲ R ▲	M RTLS <input type="text" value="0"/> K Rota <input type="text" value="0"/> AOA <input type="text" value="0"/> ATO <input type="text" value="0"/> Accel <input type="text" value="0000"/>	APU % L ▲ C ▲ R ▲	React O2 <input type="text" value="0"/>	F Deck Fire P Pay Fire B Bay Fire A Aft Fire
1 - Left Display			2 - Right Display			
P Autopilot Manual R APU On OFF M SSME On OFF O OMS On OFF		S SRB Sep E ET Sep V ET Vent Event Time <input type="text" value="000000"/>		Back Q X+ Fwd - W Start E Pulse Left A Y+ Rt - S Start D Pulse Up Z Z+ Dwn - X Start C Pulse Roll T X+ - Y Start U Pulse Ptch G Y+ Dwn - H Start J Pulse Yaw B Z+ Rt - N Start M Pulse		
Auto Shutdown Enable D SSME A APU T Throttle <input type="text" value="0"/>		3 - Control		4 - Digital Pilot		
Air Speed <input type="text" value="0"/>		Rudder <input type="text" value="0"/>		Drop Rate <input type="text" value="0"/>		
S Spd Bk <input type="text" value="0"/>		Drp Accel <input type="text" value="0"/>		P Off On Fail <input type="text" value="0"/>		
B Bd Flp <input type="text" value="0"/>		Elevons <input type="text" value="0"/> <input type="text" value="0"/>		O Open Close L Lock Unlock		
F Flaps <input type="text" value="0"/>		V Camera Window		Q Pam Lk A Pam Lk Z Pam Lk Unlock Unlock Unlock 1 Launch 2 Launch 3 Launch Fail <input type="text" value="0"/> Fail <input type="text" value="0"/> Fail <input type="text" value="0"/>		
5 - Landing		G Land Gear		6 - Payload Bay		
SSME 1 <input type="text" value="0"/>		GPC 1 <input type="text" value="0"/>		Liquid O2 <input type="text" value="0"/>		
SSME 2 <input type="text" value="0"/>		GPC 2 <input type="text" value="0"/>		Liquid H2 <input type="text" value="0"/>		
SSME 3 <input type="text" value="0"/>		GPC 3 <input type="text" value="0"/>		MMH <input type="text" value="0"/>		
APU 1 <input type="text" value="0"/>		GPC 4 <input type="text" value="0"/>		N2 <input type="text" value="0"/>		
APU 2 <input type="text" value="0"/>		GPC 5 <input type="text" value="0"/>		7 - Engines		
APU 3 <input type="text" value="0"/>		8 - Weapons		L FIRE Q Dis. Hi W Me E Lo CO2 Temp A Int. Hi S Me D Lo <input type="text" value="000"/> 18 Z Dur. Hi G Me C Lo M FIRE R Salvo Hi T Me Y Lo Avail F Inter Hi G Me H Lo <input type="text" value="00"/> P On <input type="text" value="0"/> Off		
P On Off L Lock Unlock D Deploy Contact <input type="text" value="0"/>		S Shoulder E Elbow W Wrist O Open Close		Window View F10		
9 - RMS (Arm)						

# U.S. Space Shuttle Glider Kit

Your Space Shuttle glider is a 1:200-scale model of the U.S. Space Shuttle Orbiter. The airplane-like Orbiter will function as a space station which can remain in Earth orbit for up to 30 days at a time. It will normally carry about seven people; three of these will be astronaut-pilots; the others will be specialists in some area of science or technology. From the space-station Orbiter, this crew will be able to conduct many of the space missions which until now have been executed from Earth; they will be able to launch satellites (weather, communications, navigation, Earth Resources), scientific spacecraft (to explore and study our solar system), and military satellites and to conduct onboard experiments. At the end of each mission, the 120-ft. Orbiter will be piloted back to Earth and land, like an airplane, on an airstrip. It will then be refurbished so that in two

weeks it is ready for another mission. In this manner, each Orbiter is expected to be used at least 100 times.

The orbiter and its engines are just part of the Space Shuttle system. The other parts are the solid rocket boosters (SRB's) used for launch and the external tank that contains liquid propellant for the engines. All of these parts are reusable except the tank, which is jettisoned just before the Shuttle Orbiter achieves Earth orbit. This ability to reuse costly equipment, as well as the ability to conduct missions from Earth orbit, will substantially decrease the cost of space operations. Just as during our Earth-bound years we relied upon trucks, trains, and airlines to provide transportation, so during the coming years we will rely upon the Space Shuttle to provide transportation to and from space.

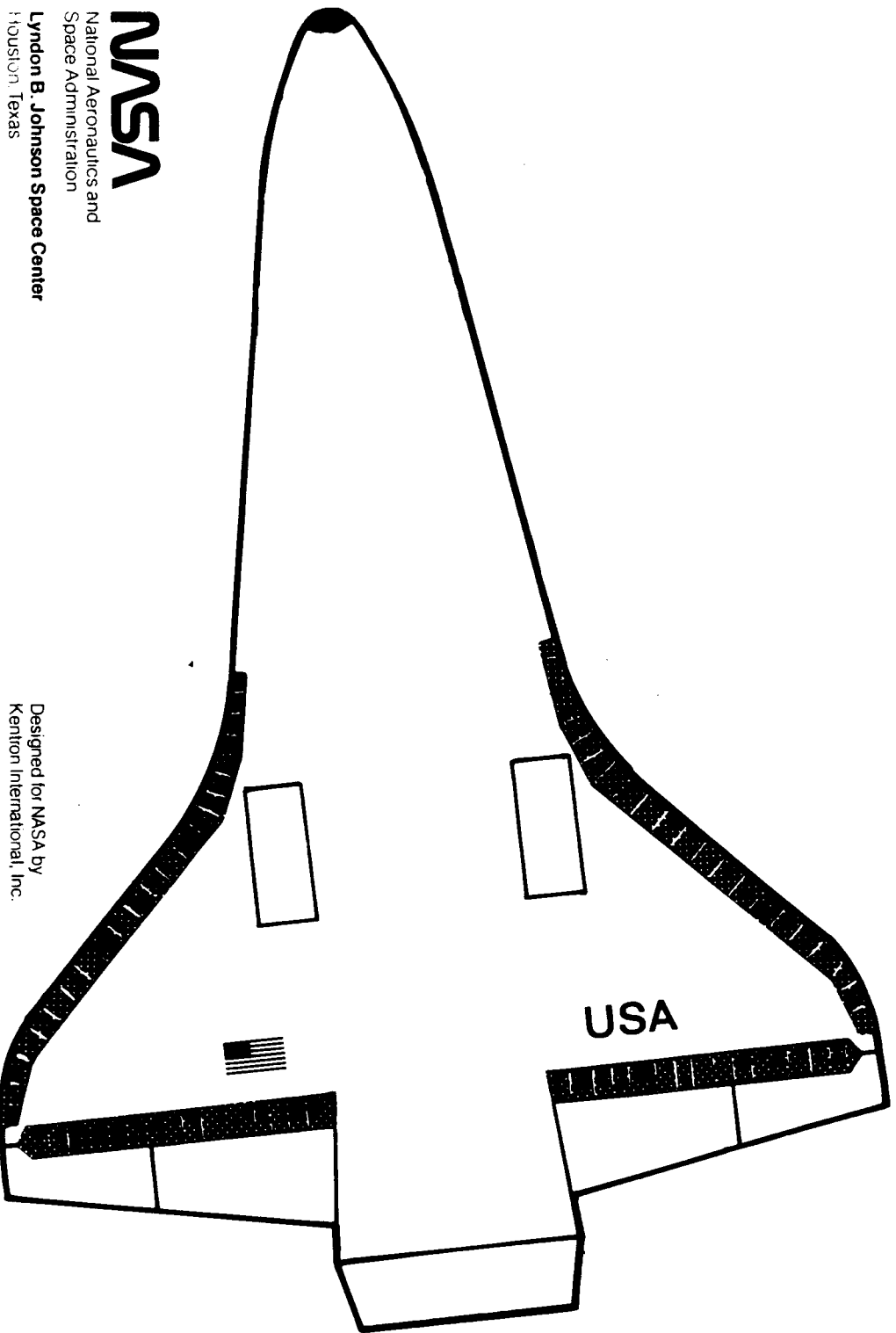
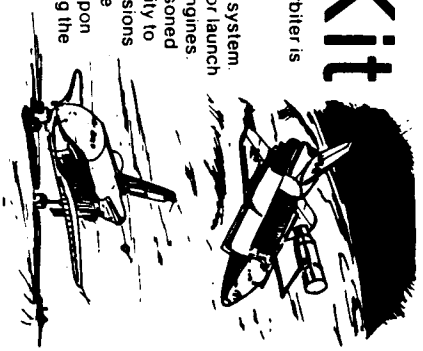

# NASA

National Aeronautics and  
Space Administration

Lyndon B. Johnson Space Center  
Houston, Texas

Designed for NASA by  
Kenton International, Inc.

**Assembly Instructions:** Read carefully before assembly.

1. Cut out all parts using scissors.
2. Cut out V-shaped notches on Fuselage to create tabs along outside edge. Fold tabs out.
3. Glue or tape three Nose Weights to underside of nose of your glider.
4. Use the fourth weight provided if needed for extra trim after assembly.
5. Fold Fuselage along middle line.
6. Starting at the nose, glue or tape fuselage to Deck and Wing Assembly. Match tabs on Fuselage exactly to those printed on Deck and Wing Assembly.
7. To close the nose, glue or tape the two halves together using tabs provided.
8. Fold Vertical Stabilizer Assembly. Fold out tabs A and B. Except for tabs A and B, glue or tape Vertical Stabilizer Assembly to make one solid piece.
9. Attach Vertical Stabilizer to Fuselage, matching tab A with point A and tab B with point B.

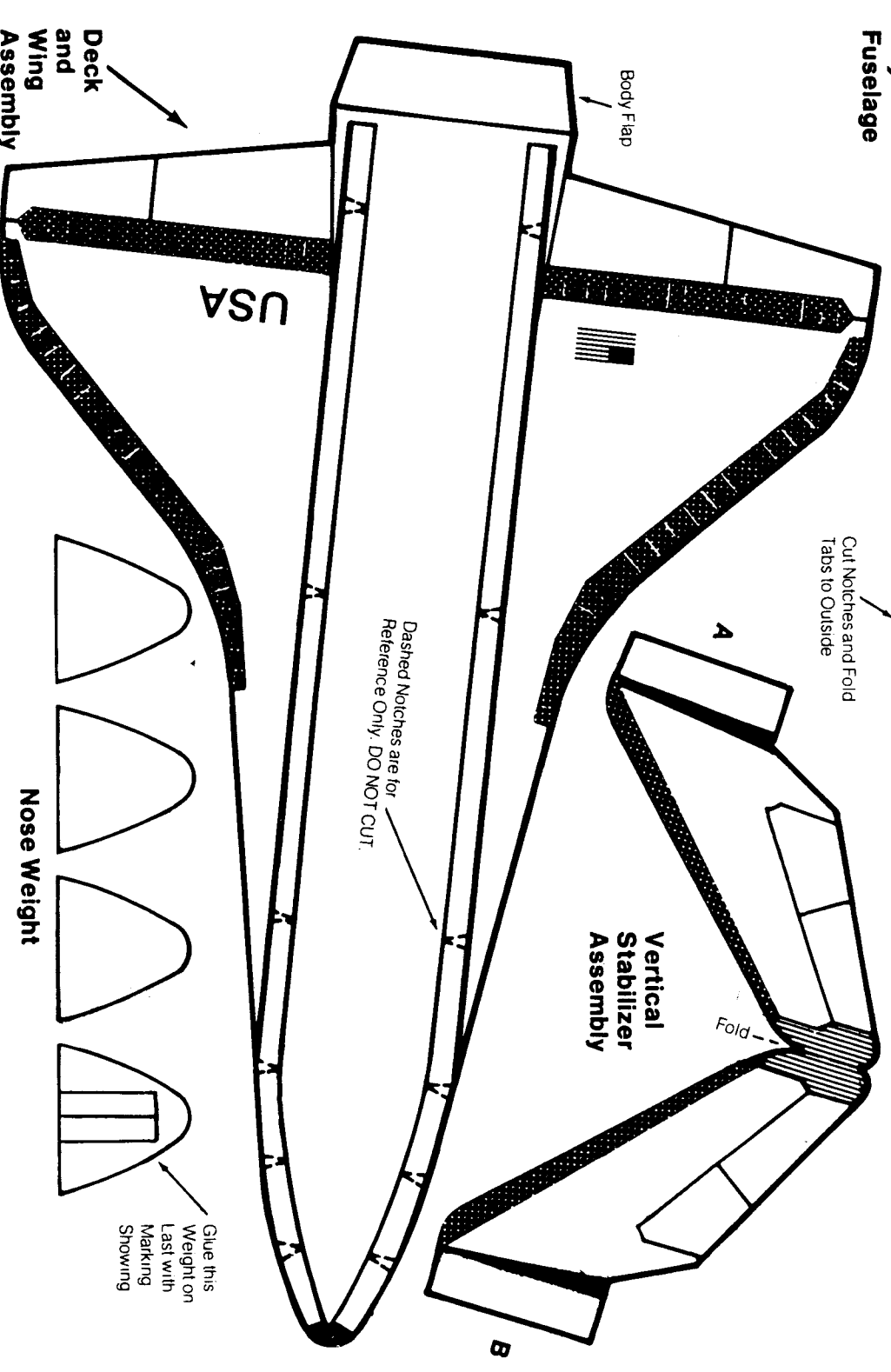
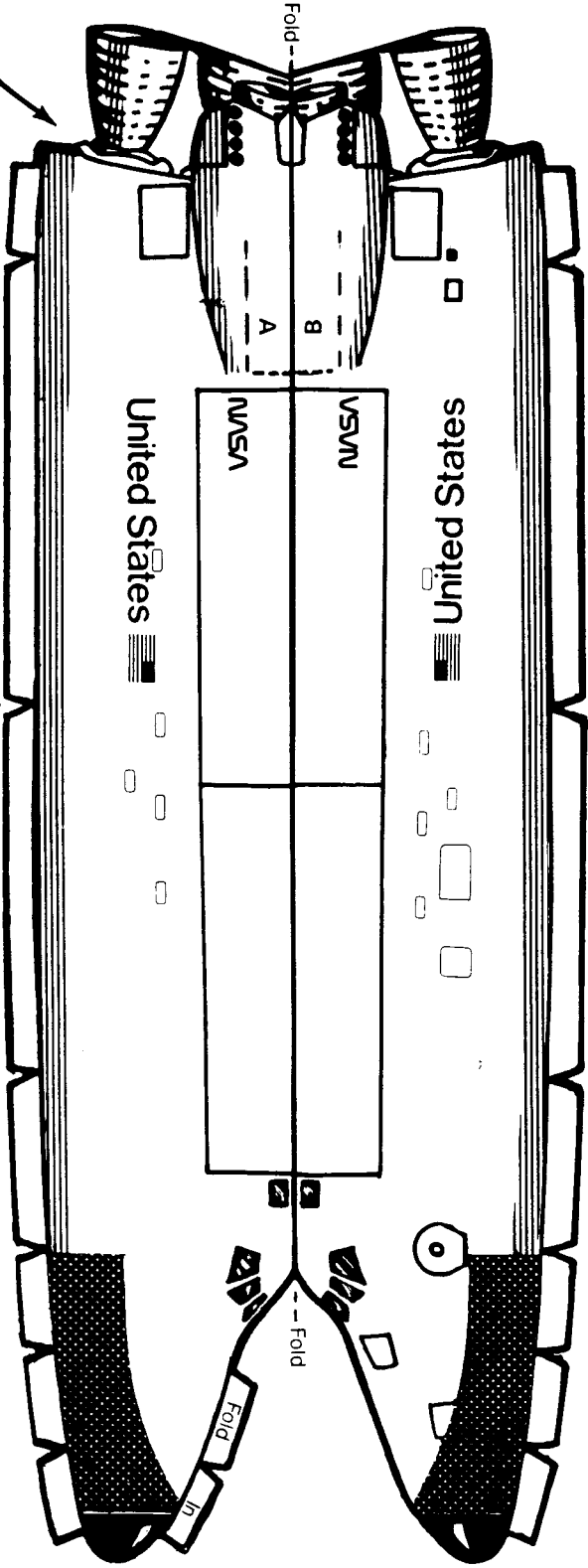
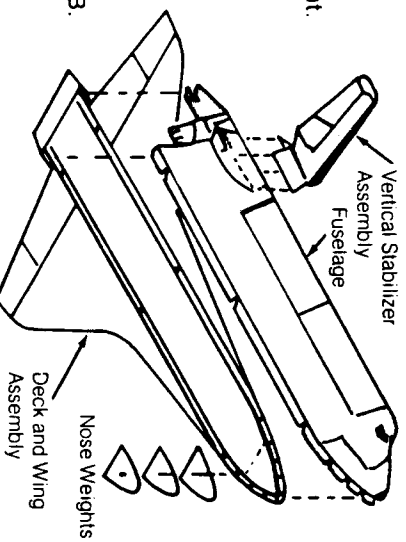

**Nose Weight**

Glue this Weight on Last with Marking Showing

## **Spectrum HoloByte™**

2061 Challenger Drive  
Alameda, CA 94501  
(415) 522-3584

### **ORBITER**

Copyright © 1986 by Sphere, Inc.  
All rights reserved

ORBITER Simulation Game designed and developed by:

Sean Hill                      Gordon Walton  
D.R. Gilman                  Mike Jones  
John Keene                  John Polasek  
of PC Services, Inc., and Digital Illusions, Inc.  
and  
Jeff Sauter of Spectrum HoloByte, Inc.

Cover Art by:  
Highlight Graphics of Boulder, Colorado

Graphic Art by:  
Zeppelin Graphics of Boulder, Colorado

### **LIMITED WARRANTY/REGISTRATION INFORMATION**

The enclosed limited warranty/registration card must be returned to Spectrum HoloByte as soon as possible to ensure replacement of defective materials and receipt of update information.

#### Trademark Notices:

ORBITER is a trademark of Sphere, Inc.  
PC Mouse is a trademark of Mouse Systems Corporation.  
IBM is a registered trademark of International Business Machines Corp.  
IBM PC, and PCjr are trademarks of International Business Machines Corp.  
HiCard is a trademark of RYBS Electronics, Inc.  
Plink86 Plus is a trademark of Phoenix Software Ltd.

## **DEDICATION**

ORBITER is dedicated to the memory of the crew of the Challenger:

**Frances R. Scobee**..Commander  
**Michael J. Smith** . . . . . Pilot  
**Ellison S. Onizuka**...Mission Specialist  
Gregory B. Jarvis.....Payload Specialist  
**Ronald E. McNair** . . . .Mission Specialist  
**Judith Resnik**.....Mission Specialist  
**Christa McAuliffe**.....High School Teacher  
("Teacher In Space")

The Space Shuttle Challenger exploded 75 seconds after launch on January 28, 1986. There were no survivors.

NASA's shuttle system successfully launched 24 shuttle flights before the fatal Challenger explosion.

These men and women 'were pioneers, individuals who understood the risks associated with spaceflight. Their main objective was to enhance our knowledge of the final frontier. Space exploration will continue; we are deeply saddened that this crew's part in it ended so soon.

## Table of Contents

	<u>SECTION</u>	<u>PAGE</u>
	Introduction	4
1.	Using the ORBITER Manual	6
2.	Getting Started	7
	Minimum System Configuration	7
	256k System Users	8
	Installing DOS on Disk 1	8
	Running ORBITER From the Floppy	8
	RAM Disk Installation	9
	Hard Disk Installation	10
	Creating an Autoexec.Bat File	11
	Quick Start for Advanced PC Users	12
	8887 Chip	12
	Mouse Installation	13
	Keyboard Variations	13
	Warning	13
	Quitting ORBITER	13
3.	A Training Flight "Walk-Through"	14
4.	Simulation Activities Log	30
	Save Game	31
	Open Saved Game	31
5.	ORBITER Pull-Down Menus	32
6.	ORBITER Panel and CRT Screens	36
	Diagrams	42-43
7.	Maneuvers and Operations	62
	Orbital	63
	MMU	65
	RMS	68
8.	Keyboard Equivalents and GPC	
	Commands	70
9.	Object Identification	74
10.	Glossary	76
11.	Acronyms	81
12.	ORBITER Operating Information	86

## INTRODUCTION

Imagine sitting in the commander's seat of NASA's shuttle Orbiter...

With your back to the Earth and your face to the heavens you prepare yourself for the final seconds before lift-off. Moments from now you will experience the effects of 3 g's (3 times the force of gravity on earth) as the shuttle system lifts off from the Kennedy Space Center. For now your thoughts turn to final system checks and the voice of Mission Control. At T-00:03 seconds the first of three main engines ignites, at T-00:02 the shuttle's Solid Rocket Boosters ignite and you are on your way. Five on-board computers process thousands of bits of data each second as you are hurtled into space. At T+02:12 you are traveling at Mach 4.5 and have reached an altitude of 28 miles. At T+06:30 minutes into the flight you are traveling at almost 15 times the speed of sound. Imagine...

ORBITER is the shuttle simulator based, on the actual commands and procedures used by NASA. It will test your knowledge about the shuttle and the mechanics of space flight.

Panels and graphic displays simulate, as closely as possible, the experience of launching, landing and performing the delicate missions required of the astronauts who pilot and crew the space shuttles:

for NASA. Your objective is to launch the shuttle, complete the mission of your choice and safely land the space craft at the specified base. Random mechanical failures and complications may occur as you attempt to meet your mission objectives.

The activities you perform and the number of hours expended during the mission will be kept in the Astronaut Log. You will have a limited amount of time to complete your flight objectives before your life support systems run low and you are forced to return to Earth.

You are about to experience one of the closest things to actually being in the commander's seat of NASA's shuttle. You are about to fly ORBITER...

## 1. Using the ORBITER Manual

The ORBITER manual is not a technical reference manual, but an operations manual for the ORBITER program. We feel that there are many excellent reference manuals available (some are listed on the last page of this booklet) and did not want you to have to bear the extra costs, in the form of a higher package price, to create such a document.

Section 2 describes the program installation procedures for several different system configurations. Choose the instructions which describe your system and this section will guide you, step-by-step, in getting the program started.

Your manual was written to help you get flying in the shortest time possible. This "real-time" shuttle simulator models the controls and instrumentation found in the actual Space Shuttle Orbiter. Since experience is the best teacher, Section 3 provides a brief walk-through of the ORBITER training mission. We strongly recommend that you use the walk-through to learn basic ORBITER operations. Once familiar with launch, orbit, and landing procedures you will be prepared to fly other more challenging ORBITER flights.

Sections 5 and 6 provide detailed explanations of ORBITER pull-down menus, panels, and CRT screens. To develop the skill necessary for complex orbital maneuvers Section 7, *Maneuvers and Operations*, supplies additional information on shuttle and Manned Maneuvering Unit (MMU) orbital mechanics. Also included in this section are operating instructions for the Remote Manipulator System (RMS).

Section 8 lists the keyboard keys used in place of selecting menu options. It also briefly describes mouse controls and lists the General Purpose Computer input commands.

## 2. Getting Started

### Minimum System Confiuration:

For an IBM PC or 99.9% compatible system.

1. DOS 2.0 to 3.0 for 256k; DOS 3.1 requires over 256k.
2. Two 360k floppy drives; or one 360k floppy and a hard drive; or one 360k floppy with 256k of available memory and a 256k RAM disk.
3. Color graphics card.
4. Graphics monitor (color or monochrome).

### Optional Equipment:

- PC Mouse.

Before you can play ORBITER, you must be familiar with the basic operations of your IBM or equivalent computer. In particular, you will need to know how to format a disk, make a backup, create a simple text file (copy con), and be familiar with the keyboard. If you are using a hard drive you must also know how to make a subdirectory and copy files into it. Refer to your Operator's guide if unfamiliar with your system's operation. *This program is not copy protected. Please write-protect the master, then make backups and file the masters for safe keeping. **The following procedures will be performed on the backup copies, NOT THE MASTERS.***

ORBITER does not contain the System or Command.Com files necessary to boot from the program disks. If you wish to boot directly from the ORBITER disks it will be necessary to install the system files to your Disk 1 backup. We *elected not to provide these files as it would cost us a licensing fee which we would then have to pass on to you, the end-user.*

**The advanced PC user should go directly to page 12-F.**



256k System Users: Section A, Installing the System to Your Floppy Backup, is necessary if you have only 256k of RAM. It is optional if you have over 256k.

A. Installing The System to Your Floppy Backup:

1. Format a disk using the FORMAT/S command. (Remember that formatting will erase whatever was on the disk.) This command will both format and install the System and Command.Com onto your disk.
2. Copy the files from Disk 1 onto this new system disk using the COPY \*.\* routine.
3. Disk 2 does not need the system file on it so you will simply use the DISKCOPY command to copy Disk 2 to a backup disk (Diskcopy will format the disk for you).

B. Running ORBITER From Two Floppy Drives:

*If you have installed the system onto your backup disks .*

1. Put Disk 1 in drive A and Disk 2 in drive B and boot (i.e., turn the power on). Enter the Date and Time.
2. At the A prompt (A>) type in ORBITER.
3. The following message will appear\*\*: "PLINK86 overlay loader - Can't find file ORBITER.OVL. enter file name prefix (X: or path name/) or '.' to quit=> " .
4. The ORBITER.OVL file is located on Disk 2, you must tell the computer in which drive you have Disk 2, in this case, type B:  
(To install an Autoexec.bat file to perform this task for you see Section E, Creating an AUTOEXEC.BAT File. being sure to substitute the appropriate drive designators.)

*If you have not installed the system file onto the backup disks :*

1. Boot with your system disk and enter the date and time.
2. Put Disk 1 in drive A and Disk 2 in drive B.
3. Follow the procedure above (B-2 through 4).

C. RAM Disk Installation:

You must have enough overall memory to partition at least 256k for the RAM disk with 256k left to run the program.

1. Copy the files from disk 1 or disk 2 to the RAM disk using the COPY \*.\* command.
2. Edit the VOLUMES.DAT file on Disk 1 to specify the location of the program and overlay files (EXE-OVL); use the following procedure:
  - a. Type in TYPE VOLUMES.DAT (to view the current contents of this file).
  - b. The default parameters are for the A and B drives; these must be changed to reflect the designator for the boot and RAM drives.
  - c. To create a new VOLUMES.DAT file, at the drive prompt, type in COPY CON VOLUMES.DAT (carriage return).
  - d. Next, type in: (*d* is the drive specifier)  
*d:* (cr) *Location of ORBITER.EXE*  
*d :* (cr) *Location of ORB/TER.OVL*  
*O* (cr) *program queueing speed - fast\**  
[Ctrl] Z (cr)

For example, if booting ORBITER from A and your RAM disk is C your instructions would look like this:

```
A>COPY CON VOLUMES.DAT
A:
c:
O
^Z
```

When you are finished, the screen will inform you that one file has been copied.

- e. To verify that the new file is correct, type: TYPE VOLUMES.DAT and the file contents will appear on the screen.
3. To run ORBITER from the program drive and RAM disk, at the drive prompt type ORBITER. The following message will appear\*\*: "PLINK86 overlay loader - Can't find file ORBITER.OVL. enter file name prefix (X: or path name/) or '.' to quit=>"

4. The ORBITER.OVL file is located on Disk 2, you must tell the computer in which drive you have Disk 2, followed by a colon, e.g., C:.

(To install an Autoexec.bat file to perform this task for you see Section E, Creating an AUTOEXEC.BAT File, being sure to substitute the appropriate drive designators.)

#### D. Hard Disk Installation:

1. Boot your system using your hard drive (2.0 or later). Enter the Date and Time.
2. Create a directory (MKDIR) for the ORBITER program or use an existing subdirectory.
3. Go into the new subdirectory (using the CD(dimame)) command.
4. Insert ORBITER Disk 1 into your floppy drive and copy the files from disk 1 into the subdirectory using the COPY \*\* command.
5. Eject Disk 1. Insert ORBITER Disk 2 into the floppy drive and follow the same instructions as for Disk 1. Eject Disk 2.
6. While in the Orbiter subdirectory, edit the VOLUMES.DAT file. The default is set for a double floppy drive system, so it will be necessary to change it to read both sets of files (ORBITER.EXE AND .OVL.) from your hard drive subdirectory.

#### Follow this procedure:

- a. Type **COPY CON VOLUMES.DAT** (carriage return)
- b. Type in (d):\ (subdirectory name)\ (cr)  
(d) :\ (subdirectory name)\ (cr)  
0 (cr) - program queueing speed - fast  
**[Ctrl] Z** (cr)

For example, if your hard drive designator is C and your subdirectory name is **ORBITER**:

```
C>(ORBITER) COPY CON VOLUMES.DAT
C:\ORBITER\ -don't forget the extra backslash
C:\ORBITER\
0
^Z
```

- c. The screen will say "One file(s) copied."
- d. To verify that the new file is correct, type in: TYPE **VOLUMES.DAT** and the contents of the file will print to the screen.

7. To run the program go into the appropriate subdirectory and type **ORBITER**.

#### E. Creating an AUTOEXEC.BAT File:

To install an Autoexec.Bat file to perform the task of answering the PLINK86\*\* query and selecting to run the ORBITER program, follow the procedure outlined below. It is necessary to have the *end-user create this file to tailor it to his or her particular system configuration.*

1. With Disk 1 in the A drive, at the A> type in COPY CON **AUTOEXEC.BAT** (carriage return). The system is now ready to receive your instructions. (In step 2, "d" represents your drive designator where the first drive contains ORBITER Disk 1 and the second drive contains Disk 2.)
2. Type in **DATE** (carriage return)  
**TIME** (cr)  
**PATH=d ;;d ;;** (cr) For hard drives, specify filename (e.g.,  
d:\orbiter;d:\orbiter;)  
**ORBITER** (cr) - to load the ORBITER program - optional.  
**[Ctrl] Z** - to end the batch file entry.  
For example. if you are using two floppies A and B, where Disk 1 is in drive A and Disk 2 is in drive B, you would type in:  
A> COPY CON AUTOEXEC.BAT (cr)  
DATE  
TIME  
PATH=A::B; (cr)  
ORBITER (cr)  
**[Ctrl] Z** (cr)

3. If the system is installed, boot from the ORBITER disk. If booting from DOS, type in **AUTOEXEC** instead of ORBITER.

#### **F. Quick Start for Advanced PC Users:**

##### Two floppies with ORBITER as boot disk:

- 1) Make a backup for Disk 1 using the FORMAT/S command and copy the ORBITER 1 files onto it. Do a DISKCOPY for the Disk 2 backup.
- 2) Create an AUTOEXEC file to: 1) answer the PLINK86 query\*\* (i.e., **path=a:b;**; - specifies the location of the .EXE and .OVL files); and, 2) (optional) to load the ORBITER program.

##### One floppy and RAM disk with ORBITER as the boot disk:

- 1) Make a backup for Disk 1 using the FORMAT/S command and copy the ORBITER 1 files onto it. Do a DISKCOPY for the Disk 2 backup.
- 2) If there is room on Disk 1, transfer the RAM driver to the Disk 1 backup.
- 3) Edit the VOLUMES.DAT file to: 1) assign drive locations for the .EXE and .OVL files; and, 2) specify the program queueing speed\*.
- 4) Create an AUTOEXEC file to: 1) copy either Disk 1 or Disk 2 to the Ram disk; 2) answer the PLINK86 query\*\* (i.e., **path=d;d;**; - specifies the location of the .EXE and .OVL files); and, 3) (optional) to run the ORBITER program.

##### J-lard drive installation:

After copying the files to the subdirectory, edit the VOLUMES.DAT file to specify : 1) the location of both the .EXE and .OVL files (e.g., both are in *d:\fi\ename*); and, 2) the program queueing speed\*.

. *Mission Control and the On-Board computers will prompt you to execute a command. The delay between the prompt and the input is entered in this . DAT file. 0 queue = 10 seconds. faster systems enter a higher number, in increments of 10, for longer intervals (up to 32767).*

\*\*The *P/ink86-Plus* program manages all of the program overlay files located on separate drives. The query prompt will not appear if the .OVL files are in the same location, e.g., in the same subdirectory on a hard disk.

#### **G. 8087 Math Coprocessor installation:**

ORBITER will recognize this chip automatically upon booting.

#### **H. Mouse Installation:**

ORBITER supports the PC Mouse™ and compatibles. You must first install the mouse driver which came packaged with your mouse and then run ORBITER as described in the Getting Started Section of the manual. A text screen will appear letting you know if the mouse driver has been installed. You should be familiar with the operation of your mouse, particularly selecting items by clicking on them and operating pull-down menus.

#### **I. Keyboard Variations:**

ORBITER is mainly a keyboard driven program. It is important that you be familiar with the variations of your particular keyboard. For example, the [Fn] key on the IBM PCjr must be pressed in conjunction with other keys coded in green in order to execute that function. This manual will only refer to the standard IBM PC keyboard.

#### **Systems with less than 320k:**

ORBITER will use all of the available memory on your system so do not run ORBITER with any co-resident memory programs. 256k users may not be able to install the mouse driver.

\*\*\*\*\*

**Quitting ORBITER:** To Quit ORBITER you must be in the CRT screen. (Press the space bar or escape key to toggle back and forth between the Panels and CRT's.) Select the **File** menu by using the left or right arrow until **File** is highlighted, then use the down arrow to "pull-down" the menu. Press the down arrow again until Quit is highlighted, then press Return or Enter to process your selection. Select [0] for OK when asked if you are sure you wish to quit.

*IF YOU HAVE FOLLOWED THESE INSTRUCTIONS, BUT FEEL YOU NEED FURTHER ASSISTANCE, PLEASE CALL OUR TECHNICAL SUPPORT DEPARTMENT AT (303) 443-0191, IN BOULDER, COLORADO.*

### 3. A Training Flight "Walk-Through"

The following walk-through was designed to allow you to successfully complete your first mission by using the simulation itself as the flight instructor. Just as the real space shuttle is more complex to fly than a single engine aircraft, ORBITER is a bit more complex than the average flight simulation game. You will learn ORBITER in a shorter period of time if you follow the procedure outlined below.

If the simulation moves faster than your pace in the walk-through, select *Suspend* from the **Game** pull-down menu on the CRT screen (using the arrow keys) or hit the **[Alt]** and S keys simultaneously. When you are ready to go on, select *Continue* from the **Game** menu or hit the **[Alt]** and Q keys. You will be requested to suspend the game periodically to read important instructions prior to executing them.

Boot ORBITER as instructed in the **Getting Started** section. After your game is loaded, the ORBITER signature graphic appears. This signals the beginning of the simulation and the start of your adventure. Your first view inside the ship is of four of the nine available control panels, **Control**, **Left Display**, **Landing**, and **Right Display**. The panels each occupy one quarter, or quadrant, of the panel screen. ORBITER will automatically display these panels every time the program is booted.

The panels are changed using the F1 through F10 function keys. The panel title, with corresponding function key number, is located in the lower left of each panel. To select a particular panel so that you may activate or change it, use the **[Tab]** key (this will select each panel in a clockwise rotation), or the numeric keypad keys **[Home]**, **[Pg Up]**, **[End]**, or **[Pg Dn]** to go directly to the desired panel. Each

of the numeric keypad keys occupies a corner of the keypad corresponding to a corner of the panel screen (e.g., **[Home]**, which is in the upper left corner of the keypad, selects the upper left quadrant on the panel screen). The selected panel will be outlined in white and the panel title will appear as white on blue. Once a quadrant has been selected and a function key hit, the new panel displays on the screen and becomes operable.

Also displayed on the screen beneath the panel windows is a message bar. Mission Control's instructions are detailed on the Message CRT screen but the last two lines of the Message CRT will be displayed in this location. This will allow you to receive messages even though you are not in the CRT screen.

In most panels there are control buttons. You will see a letter assignment, in red if you are using a color monitor, next to the control description.



To operate a control within a panel make sure that the desired panel is highlighted. Then hit the letter on the keyboard which corresponds to that control button, or select the letter using the left button on the mouse. In most cases these are toggle buttons, meaning that the same letter might be used to turn a control either on or off. If a control is already active, or you have selected it, it will be highlighted in red, or shaded if you are using a monochrome monitor.

Because the launch sequence requires extensive use of the **Control** panel (you cannot successfully launch without it) it's a good idea to keep it displayed until the on-board computer takes over at approximately T-00:00:05 (5

seconds before launch). The other three panels are used to keep track of speed, fuel, abort options and status displays.

The **CRT's** (cathode ray tubes) are displayed on a separate screen. To view the CRT's press the space bar, or **[Esc]**, or the right button on the mouse. Pressing any of these keys will allow you to toggle back and forth between the Panels and the CRT displays. There are a total of seven CRT options. You will be able to choose from five available options depending on which phase of the flight you are in. Below the CRT you will see information on which configuration is being displayed.

The CRT being displayed now is Messages. To change the CRT views you will use the Functions keys, F1 through F5. Some of the CRT's will have split screens allowing message text to appear. For the purpose of this walk through leave *Messages* [F2] on the screen since Mission Control's instructions will be detailed here. If you do not have Messages displayed, and you hear a warning "beep," go to Messages CRT and the warning message will be displayed. (Details of all panels and their functions are contained in the Orbiter Panels and CRT Screens section of the manual.)

There are seven menu options listed at the top of the CRT screen. Use the arrow keys or the left button on the mouse to operate the menus. The left and right arrows will move the cursor bar to the left or right respectively. To view the menu items using the keyboard, use the down arrow to "pull-down" the menu. To select a menu item using the keyboard, use the down or up arrow keys until the desired choice is highlighted and then press the [Return] or [Enter] key. To "close" the menu use the up arrow until the menu listing is no longer visible. To view the menu items using

the mouse, click the left button on the menu item and hold the button down. To select an item on the menu, "drag" the mouse toward you until the desired item is highlighted, then let go of the button to select that item.

You will now begin your first mission. Select New from the **Mission** menu. A series of dialog boxes will appear allowing you to choose various game parameters. The Orbiter *Configuration* dialog box is displayed first. This dialog box allows you to select the mission phase, **Launch, Orbit,** and/or **Landing**. ORBITER will automatically select all three phases (these are already highlighted) along with the advanced level mode (fewer prompts).

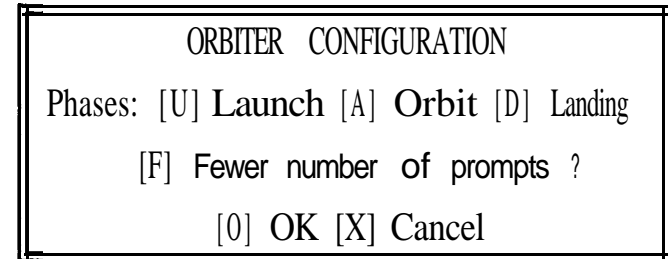

For your walk-through flight make sure you leave each of the phase boxes selected (highlighted). Hit, or click on, the **[F]** key for fewer prompts. The F and the brackets will no longer be highlighted. (We want the walk-through to be fully prompted.) Select [0] for **OK**.

The *Mission Selection* dialog box will display next. For the purpose of this walk-through select the *Training* mission [T]. After you select **OK** the *Current Mission* dialog box will appear.

The *Current Mission* dialog box displays a description of your mission assignment from the category you have just selected (i.e., Training). This mission will involve a launch of the Hubble telescope. If during the simulation you would

like to read the mission description again, select Current from the **Mission** menu.

The pre-launch will now begin at T-01 :29:49 (1 hour, 29 minutes, and 49 seconds before launch). Event Time - shown in the Control Panel or below the CRT window in the CRT screen - depicts the actual time it would take for the real shuttle system to go through this mission. The simulation time is compressed and the ratio (Time Compression) is shown next to the Event Time on the bottom right-hand side of your CRT screen. Watch the directions from Mission Control on the *Messages* [F2] CRT. You have about ten seconds to respond when you are asked to "Please acknowledge." Reply "Roger" using one of the methods described below.

Execute your acknowledgement by pulling down the **Communications** menu and selecting either *Affirmative* (Yes) or Negative (No). Keyboard equivalents are also displayed on the menu; [Alt] key and [A] (O A) for Affirmative; [Alt] key and [N] (O N) for Negative. Using keyboard equivalents to respond to Mission Control permits you to play the game at a quicker and more realistic pace.

*{The following commands from Mission Control will be given swiftly It may be helpful to suspend the game here and read through the next couple of paragraphs.}*

When you are asked to "start cabin leak check...by entering ITEM 50 EXEC..." use the keyboard to type in the first letter of each word, and the requested number keys (i.e., [I] [5] [0] [E]). What you have entered will be displayed in the blank rectangle, entitled Command Window, on the lower right-hand side of the CRT screen. If you make an error, type [C] for Clear or backspace and begin again. Follow this procedure for all of the computer input commands.

(See Section 8, Keyboard Equivalents and GPC Commands.)

Mission Control will alert you for an advisory check on the mission abort options. The panels screen will appear so that you may watch for the Abort lights in the **Left Display** panel to blink on and off three times. Acknowledge advisory check to Mission Control.

Mission Control will ask you to initiate the APU prestart procedure and press the APU START button. You will find the button [R] in the **Control** panel next to *APU On/Off*.

Close the ET Vents by selecting the [V] key (*ET Vent*) in the **Control** Panel.

The next Mission Control message will prompt you to set the APU and Main Engine Auto Shutdown buttons on. To do this, select the [D] and [A] keys under *Auto Shut-Down Enable* in the **Control** Panel.

*{Suspend the game here for a moment until you have read through the next two paragraphs.}*

At this point in the pre-launch, the on-board computer takes over and the Message CRT prompts you to press the manual button to do a non autopiloted launch...do **not attempt to do so on this training flight walk-through**. (We suggest you wait until you have launched several times before you try a manual procedure since random failures will frequently occur.) ORBITER will speed up the event time so that you will be ready for countdown in just a few seconds. Watch *Messages* for final pre-launch checks and countdown.

**Select these panels before the countdown begins.**

Tighten your safety harness and prepare for lift-off. Watch the altitude and g-forces in the accelerometer (Accel) indicator change by displaying the **Left Display** panel [F1]. CRT [F3] is automatically configured to display the launch trajectory, though this will not show your course until about 20 seconds into launch.

At approximately T+00:02:00 event-time, 2 minutes after launch (about 28 miles above the Earth), the Solid Rocket Boosters (SRB's) are jettisoned. At this point you can look out the forward windows of the Orbiter. To view out the forward window make sure you are in the panels screen, choose a panel location and hit [F10] from the function keypad. The graphics may take a moment to load; if so, a small wrist-watch icon will appear. The view outside the window may include the Earth (largest object), stars, sun (small, white), or moon (larger, blue) depending upon your position and orientation.

After SRB separation is complete, the Orbiter is simply gaining altitude. To see where the Orbiter is in relation to the Earth, choose Map from the **Views** menu. A full screen representation of portions of the Earth is displayed with a black box marking the position of the Orbiter. The map will scroll providing a whole Earth view. During launch the shuttle is moving up, therefore you will not see much sideways movement of the shuttle symbol on the map. To return to the Forward view, select *Forward* from the **Views** menu. It takes the Shuttle system approximately 50 minutes to achieve orbit. ORBITER compresses the launch time sequence so that the launch actually takes less than 11 minutes. During this time you may view the map and panels without too much effect on the run-time of the program.

At approximately T+00:09:09 event-time, the External Tank (ET) is jettisoned. CRT [F3] automatically reverts to *PAM display* since the launch view is no longer necessary.

Time Compression is a special feature of the ORBITER shuttle simulator. It is engaged automatically to compress game time while retaining an accurate "simulation-time" reading on the Event Time Clock. You may also set time compression yourself any time the Orbiter is **not under acceleration** and after you have achieved a stable orbit. To change the time compression ratio, select *Time Compression* from the **Special** menu. A dialog box will appear allowing you to select one of four time ratios. For example, selecting I-I 0 [T] causes the Event Time to advance 10 seconds for every one second of simulation time. One of your choices will be [P].1-1. This causes the simulation to operate at a rate slower than the 1 :1 game time.

Once a stable orbit has been achieved, at about 53 minutes event-time, you will have to open the bay doors. The panels to use for the Aft station are [F6 ] - Payload Bay, [F9] - RMS (arm), [F4] - Digital Pilot, and [F10] - window. Select *Aft* from the **Views** menu. This will make the **Aft** window visible in the F10 panel, however, since the doors are not yet open the window panel will be black.

To open the bay doors select the **Bay Doors** panel (F6), and press the power on button [P], followed by unlock [L], and open [O], in that order. With the doors open you may now view into the cargo bay which includes your first look at the Hubble telescope. If you wish to refresh your memory on the specifics of the mission, select *Current* from the **Mission** menu. Remember that this dialog box displays your mission assignment including information such as the

altitude and angle to assume before attempting to deploy the Hubble telescope.

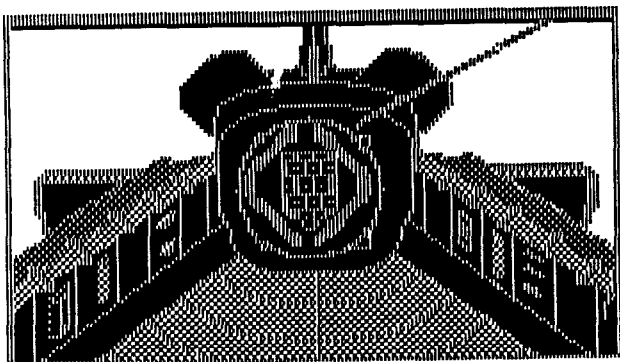

#### (Aft View into the Payload Bay)

if you are not at the proper altitude to launch the telescope select *Choose Orbit* from the **Special** menu. A dialog box will appear with two options, *Angle from Equator* and *Orbit height (km)*. Let the *Angle* box stay as it is and [Tab] to, or click on, the *Orbit height* box and enter 300 kilometers from the keyboard (the altitude specified in your mission assignment). Press the carriage return to accept your entry. The Orbiter will assume the proper orbit. Follow the changes in altitude, angle, acceleration, etc. on the Status CRT [F5]. In particular, watch the *RMin* and Max read-outs.

Having achieved the proper altitude and angle you are in position to launch the Hubble telescope. Briefly, what you will do is test the telescope, grab it with the arm, unlock it from the bay and deploy it using the arm.

Prior to launching certain objects part of your mission assignment might be to test them. To do this view the *PAM Display CRT* [F3] to see which bay contains the telescope; *PAM 1*: reads "Telescope." Enter the computer command *Spec-91-Pro* [S91 P]. *Messages* [F2] will tell you if pay-

load module 1 (telescope) tests "OK." To test payload 2 or 3 see the **Spec-Pro** Key Commands in Section 8.

Now bring up the **Payload** panel [F6]. The telescope will be launched by using the RMS (Remote Manipulator System - or Arm). Select the quadrant occupied by the **Digital Pilot** panel and bring up the RMS panel [F9]. To use the RMS, press the power button [P], then press unlock [L] and hand open [O]. A new menu, **Arm Grabber**, will now appear on the menu bar above the CRT screen. Select Telescope from the **Arm Grabber** menu. Selecting an item in the Arm Grabber menu causes the RMS to automatically grasp that item if it is within 20 meters of the shuttle. (If it is not in range the item name will appear dimmed on the menu so that it may not be selected). Contact between the arm and the telescope is confirmed when the *Contact* light in the RMS panel [F9] highlights.

Before deploying the object you must press the unlock button [Q] in the Payload panel [F6] to unlock the telescope from the number 1 cargo bay. Press the deploy button [D] on the **RMS** panel to launch the telescope with the RMS. After deploying the telescope put the arm away by selecting *Orbiter* from the **Arm Grabber** Menu, then turn the power off and lock the arm into place.

Now you must maneuver the spacecraft away from the telescope to make sure the two do not collide. *Before attempting this maneuver* you may wish to see how far the telescope is from the shuttle. To do this, pull up the *Orbital CRT* [F4] and hit the [Pg Dn] key to move the selection bar to the "telescope" line. (Use [Pg Up] to move up a line at a time.)



	Min	Max	Vel	Angle	Distance	Name
a:	299	299	7720	28	0	Orbiter
b:	299	299	7720	28	0	Orbiter
c:	13115	13118	4514	13	*****	Leasat
d:	0	0	3064	23	*****	TDRS
e:	6802	6803	3495	25	*****	Westar b
f:	207	213	7764	27	*****	Station
g:	in Bay		7720	28	0	MMU

Orbiter, this is Control, You have achieved a stable orbit, Over,  
Orbiter, this is Control, Please open the bay doors to reduce internal  
heat, Over,  
Hand must be closed on Object!

Configured as: Orbital Info      Command Window

7/25/86 0:15: 9a      Event Time: 0:00:52:18      Time Compression: 1.0:1

### (Orbital CRT Display)

To view both the Orbiter and the telescope orbital specifications, go to the Status CRT [F5] and you will now see the telescope specifications showing below the "Orbiter Information" items.

Select the **Digital Pilot** panel [F4] and display it in one of the quadrants. Instigate a back X translation to move the Orbiter away from the telescope, [Q] is already set for the forward (+) movement so just press [W] to start. You may want to confirm that the telescope is clearing the Orbiter by looking out of the Forward or Aft windows.

If you would like to move away more quickly, stop your Back X by clicking on the start button [W] again, and choosing a time compression of 1-1 0 from the **Special** menu. Then restart the Back X maneuver after the time compression has been changed. When there is a distance of 100 meters between the telescope and the shuttle, toggle the start button off to discontinue the thrust. (For more information on maneuvering the spacecraft, refer to Section 7. Maneuvers and Operations.)

Once the 100 meter distance has been achieved you are ready to deorbit. (Your mission has not been completed yet!) Close the bay doors to prepare the Orbiter for re-entry. To close the bay doors, display the **Bay Doors** panel [F6], and select the Close [O], Lock, [L] and Power Off [P] buttons.

When you wish to deorbit you must enter OPS-301-PRO from the keyboard - [O301P]. After executing this command a dialog box will appear allowing you to select the landing site appropriate to your mission. Make sure *White Sands* [W] is selected, then select [O] for **OK**.

The **Control** panel must be displayed during this pre-entry sequence. Mission Control will be issuing commands so it is easiest to leave the CRT configured to *Messages*.

*{It may take several minutes to position the Orbiter properly above the Earth to allow for re-entry over the appropriate site, you may wish to enter a time compression of 1-20 for this next phase. Remember, if you are still under acceleration the Time Compression option will not highlight.}*

When prompted, enter OPS-302-PRO [O302P] on the keyboard. Mission Control will confirm that you are go for deorbit burn. Start the APU's by selecting the [R] key while in the **Control** [F3] panel: Mission Control will then prompt you to start the OMS engines. To do this you must disengage the autopilot by choosing Manual [P] while in the **Control** panel, then select [O] next to the OMS heading in the **Control** panel.

The *Message* CRT will count down the degrees as the Orbiter changes position for the OMS deorbit burn, or watch the message line on the Panels screen. Since starting the OMS engines did not fire them to full throttle, you

will be prompted to do this when the Orbiter reaches the proper attitude for the selected landing site: Remember that the **Control** panel must be displayed during re-entry. When prompted, throttle the OMS engines up to 100%. To do this, type **[T]** for throttle in the **Control** panel. To cause the throttle to increase, either type in the desired number [100] from the keyboard, or use the up/down arrows or **[+]** or **[-]** keys to change the numbers one digit at a time. The **[Pg Up]** and **[Pg Dn]** keys will give you maximum (100%) and minimum (0%) pressure respectively. Whichever method you use, be sure to press the carriage return after entering the number.

Burning the OMS engines at the specified time will cause the shuttle's orbit to fall below an Rmin point of 90km (see Status CRT [F5]). When this happens, you will be prompted to stop the OMS engine burn by selecting the **[0]** button on the **Control** panel. After the OMS engines have been shut down make sure you engage the autopilot again by selecting **[P]** from the **Control** panel.

*{If you have not already done so, change the time compression back to 1- 1 for this next phase.}*

The on-board computer will now prompt you to start the atmospheric re-entry procedures. You will start by entering OPS-303-PRO [O303P] on the keyboard. Enter each new command when prompted by Mission Control in the same way you entered the commands during launch.

*(Suspend the game here to read over the next procedure.)*

Just before entering the atmosphere you will be prompted to adjust the Orbiter's Angle of Attack (AA) so that you can match the appropriate entry attitude. During re-entry it is

crucial that you keep the AA between 10 and 12 degrees to successfully enter the atmosphere. You can monitor the AA on the *Status* CRT. Use the *Pitch* controls in the **Digital Pilot** panel to control the AA. To begin decreasing the AA, start a pitch up; i.e., leave **[G]** on Y+ and press **[H]** to start. Watch the AA to see if it gets closer to 10 - 12 degrees; if the AA increases, reverse the direction of the pitch, then wait until it reaches between 10 and 12 degrees. The on-board computer will inform you when you have matched entry attitude.

Another series of computer commands must be entered to ready the Orbiter for re-entry. Check back to the *Status* CRT when prompted to be sure your angle of attack is still within 10-12 degrees. If your entry attitude is still matched, you will be prompted to enter the OPS-304-PRO command. This command sequence loads the atmospheric entry program into the on-board computer. If the attitude does not match, adjust the AA using the *Pitch* rotation on the **Orbital** panel as instructed in the previous paragraph.

A dialog box will appear to inform you of the radio blackout during re-entry. The real time for this blackout period is around 15 minutes. You may select to leave the blackout at any time by selecting **OK** in the dialog box. If a forward window view was previously displayed you will automatically see the landing view right after you leave the blackout and have the panels screen displayed.

The **Landing, Control, and Left Display** panels should now be displayed. The camera view will give you a view of the runway from whatever position the Orbiter is in.

The window view will display the visual perspective from the window of the spacecraft.

{For this first mission, leave the autopilot on to let the computer safely land the shuttle, but watch all of the indicators so you will be familiar with the ideal landing procedures. Note: selecting any of the controls during landing will disable the autopilot. Press [P] from the Control panel to reactivate the autopilot.}

Configure the CRT to *Landing* [F3]. This option is available only during the landing phase of the mission. You will see an inverted **V** representing the Orbiter with its nose toward the runway. The *Status* CRT will display your heading and distance in relation to White Sands, along with such information as your Roll, Pitch, Yaw and latitude and longitude. The map screen is not active during landing so your position is plotted using Loc X, Y, and Z coordinates measured in meters. Loc (Location) X represents the vertical axis, Loc Y represents the horizontal axis. Loc Z represents your altitude and includes distance.

Follow your approach by switching back and forth between the *Landing* and *Status* CRT screens. When the Orbiter is on a direct heading with the runway you will see the Orbiter symbol on the *Landing* CRT over the parallel lines running through to the runway. The heading will read zero. You will see the runway in the F10 panel at a distance of approximately 3,000 meters.

While watching this process take note of the altitude, distance to runway, airspeed, and drop rate. The ideal relation between these indicators is as follows: *Altitude should be between 1/3 to 1/2 the distance to the runway. Drop rate should be approximately 1/4 the air speed.* Your airspeed is the main factor in figuring the relation between the other items. Also notice that pitch controls the drop rate and altitude; your pitch will be 0 when you are on the ground. Yaw controls the heading. To land on the runway

your heading must equal the runway heading to within 50 meters. Other hints: your drop rate at landing **MUST** be less than 12 meters per second, beyond that you will crash a very expensive Orbiter. Also, your acceleration (see "Accel" in the **Left Display** panel) must not exceed 3000 (i.e., 3 g's, or gravities).

When you are within 90 meters, of the runway, autopilot will lower the landing gear. Watch the Land Gear box highlight as the autopilot brings you in for a safe landing. Watch your message bar for shutdown procedures. After touchdown the autopilot will set the speed brake to slow the Orbiter down. When you have rolled to a stop you will be prompted to enter the appropriate shut-down commands.

**Congratulations! You have successfully completed your mission.**

## 4. Simulation Activities Log



The activities you have performed during the "Walk-Through," such as launching the telescope and completing the mission, have been recorded in the Astronaut Log. Also recorded are the total number of simulation hours spent (event time) from launch through landing.

Your missions vary in difficulty depending on the mission type. Deployment missions are the least difficult while Construct and Repair missions are the most difficult. Selecting to have fewer prompts and using manual operations provides the most challenging scenarios.

If you should "expire" during the mission your current log will be erased. In order to retain logged information it will be necessary to save your place frequently during play. You may then load the saved file and continue from the last saved position.

### To Save or Open a particular mission:

Each time you boot ORBITER a new Astronaut Log will be started. It is necessary to save each mission once it is completed so that you may continue with new missions without starting a new Log. Choosing Save from the **File** menu also saves your current position during the simulation. For example, if you must quit, but do not want to start the

program all over again, you may save your present position and continue later.

**Save:** The program will use the ORBITER program boot drive as the default save location unless you specify another drive by typing in the drive designator before the file name (e.g., **B:landing1**). You must assign a name to the file so that you may load it at a later time. Do not use spaces in the assigned name or part of it will not be recorded. The program will only save eight (8) characters for the file name. Once saved, the file will be assigned an extension of **.ORB**.

You may save ORBITER files to any formatted IBM disk. The only limit to the number of files you may save is the amount of disk space available. ORBITER needs 44k to save one game. If there is insufficient room on the disk to save the file, a message will appear on the screen informing you of this fact. If you are using 2 floppy drives, or a RAM disk, it is a good idea to have a data disk ready when you wish to save your game. Remember that if you are saving to a RAM disk, those files will be lost once you turn off the computer.

**Open:** To Open a saved file, choose *Open* from the **File** menu. If the file name does not appear in the selection box then you do not have any saved files on the ORBITER boot drive. To check the other disk drive(s) select the **[D]** key and press the up or down arrow keys to scroll to the desired drive designator (A to E); press Return. Any **.ORB** file names on that disk will appear in the box (if the box remains empty then no games are saved on that disk). To select a file, use the arrow keys to highlight the name of the desired file and then press Return or Enter. Your selected game scenario will appear on the screen. Make sure to check all disks on which you have saved ORBITER files.

## 5. ORBITER Pull-Down Menus

The following is an outline of the pull-down menus, from left to right, with a brief description of each item. If detailed descriptions are provided elsewhere in the manual, these will be referenced in the item description. Keyboard equivalents shown in the pull-down menus are listed in section 8. Keyboard Equivalents and GPC Commands.

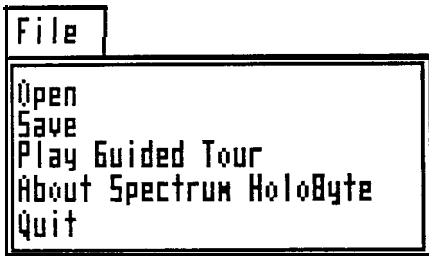

### File Menu

**Open:** Displays a list of game files saved during previous play. Also displays and allows you to select between different disk drives

(A-E). Detailed description provided in Section 4, Simulation Activity Log.

**Save:** Saves your current position during the simulation without disrupting the game sequence. Detailed description provided in Section 4, Simulation Activity Log.

**Play Guided Tour:** Demonstrates the ORBITER program. The tour (.TOU) files are on the 2nd disk.

**About Spectrum HoloByte:** A letter from the company president.

**Quit:** You may quit ORBITER at any time. Your log will be erased unless you save your game as described in Section 4, Simulation Activity Log. If you expire during the mission, the log will automatically erase.

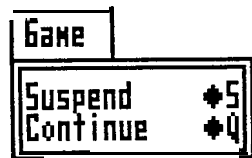

### Game Menu

**Suspend:** Freezes the game in mid-action (useful when the phone rings or if you need to plan your strategy).

**Continue:** Continues, or unfreezes, the game.

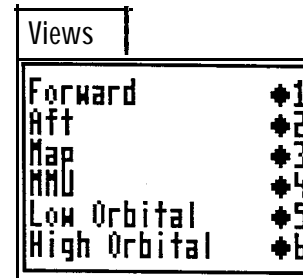

### VIEWS Menu

**Forward:** View from the Forward window. **Aft:** View from the Aft window. **Map:** Large full-screen map of the Earth depicting the Orbiter's relative position. **MMU:** Manned Maneuvering Unit station. You must select this option to use the MMU. **Low Orbital:** "Space" view of the Shuttle orbit showing its relationship with the Earth and other orbiting objects. The range is from 0 to 400 Kilometers.

**High Orbital:** The same as Low Orbital, but from a higher perspective: 400 to 4000 Kilometers. (If the Orbiter is very close to another object the names may overlap.)

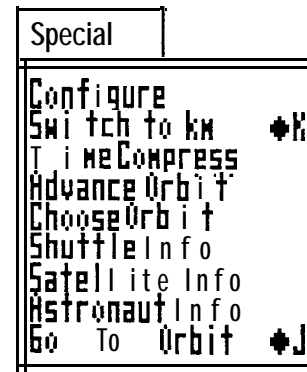

### SPECIAL Menu

**Configure:** Game feature options and current settings for *Sound* on/off, *Alarm* indication beep/flash, Text mode full/condensed, *Indicator* types analog/digital. (Configure must be selected after starting a new mission. Highlighted items may be altered during the game.)

**Switch to km/m:** Changes the distance units from Meters to Kilo-

meters or from Kilometers to Meters. **Time Compress:** Gives choice of time compression ratio (e.g., 1- 10 speeds up event time at a ratio of 10 seconds for every one second elapsed. You may also slow down the action by selecting the .1-1 option). This feature may be implemented only after you have achieved a stable orbit and when the Orbiter is *not* under acceleration.

**Advance Orbit:** A short cut, this option advances your position by one full orbit. Your resources will be expended as if you had manually accomplished this activity.

**Choose Orbit:** Allows you to select the preferred orbit instead of performing a manual OMS burn. (Manual pursuit of this activity requires much skill and patience.) This feature may be implemented only after you have achieved a stable orbit and when the Orbiter is *not* under acceleration.

**Shuttle Info:** Offers historical and current information on the actual Space Shuttle system.

**Satellite Info:** Provides some historical and current information on several satellites launched to date.

**Astronaut Info:** Activity log. It provides information on the activities performed, such as how many walks you have taken in the MMU and how many satellites you have launched and/or repaired. Should you “expire” during your mission the information will be cleared from the log unless previously saved as described in Section 4, Simulation Activity Log.

**Go to Orbit:** Takes you directly to orbit at any point in the launch phase, bypassing the remainder of the launch.

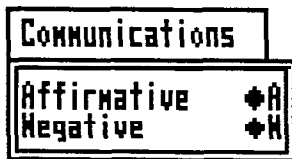

Communication Menu  
**Affirmative:** or a YES response. **Negative:** or a NO response.

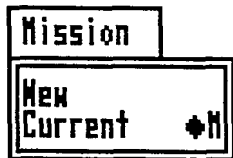

Mission Menu  
 New: Select to start a new game. This will also start a new astronaut, log unless you are continuing play from a saved game. A series of three dialog

boxes will appear. Two will prompt you to select the program configuration and mission type, and the third will display your mission assignment. See Section 3, A Training Flight “Walk-Through.”

**Current:** Redisplays the current mission dialog box.

The following two menu items appear only when the appropriate items have been selected from the RMS or MMU panels. **Arm Grabber** appears automatically when the Arm panel is selected and the power is on and the arm is unlocked. **MMU Matcher** appears automatically after you have undocked from the shuttle while in the MMU.

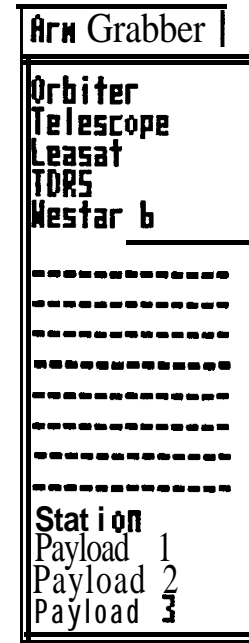

Arm Grabber Menu

The options presented in this menu list the objects which may be automatically grasped by the RMS. Items must be within 20 meters of the Shuttle. It is easier to use the Arm Grabber function when retrieving objects with the RMS, but not necessary. See Section 6, Panels and CRT Screens, for instructions on this operation.

MMU Matcher Menu

This feature is similar to the Arm Grabber in that you must select the desired object from the list. It differs in that you must activate the Grasp [G] function from the MMU panel once the object has been selected in order to lock the object to the MMU (object distance may be as far as 2 meters). This function is a short cut to getting within range of the desired object. The same functions may be achieved manually. See Section 7, Maneuvers and Operations for details.

## 6. ORBITER Panel and CRT Screens

Each panel and its components are illustrated and defined in detail in this section. The definitions below are of common terms used throughout the manual, especially with regard to the panels. A glossary of shuttle terminology and a list of acronyms are provided in the back of the manual.

### Definitions:

**Button:** A switch that may be selected by clicking the mouse on it or by hitting the corresponding key on the keyboard. The button will highlight (invert) if selected and if functioning properly. Buttons may also be used as toggle switches; that is, the same button used to switch an item to "on" may also be used to switch that item to "off."

**Control:** The position of a control displays the current setting of an Orbiter system, such as the speed brake or throttle setting. To change the numeric value of the control, select the corresponding button, enter the new value from the keyboard, and press [Return] or [Enter].

**Indicator:** Highlighted in blue, (or lightly shaded on monochrome systems) indicators display the status of various systems of the Orbiter, such as the abort site options. Indicators are for displaying information only. Particular indicators may be viewed in an analog or digital form.

**Panel**s occupy one quarter of your screen. They are composed of controls, indicators, and buttons. Panels may be displayed using the function keys (F1- F10).

**CRT:** Cathode Ray Tubes, like your computer monitor, are used to display text information or graphic images from either Mission Control or the on-board computers. CRT's may be changed using the function keys (F1 - F5).

## PANELS SCREEN

First, make sure that you are in the panels screen. The screen is divided into 4 sections, or quadrants. If you are not in the panels screen, press the space bar or escape key, or hit the right button on the mouse. This will change your display back and forth between the two types of screens, i.e., Panels and CRTs.

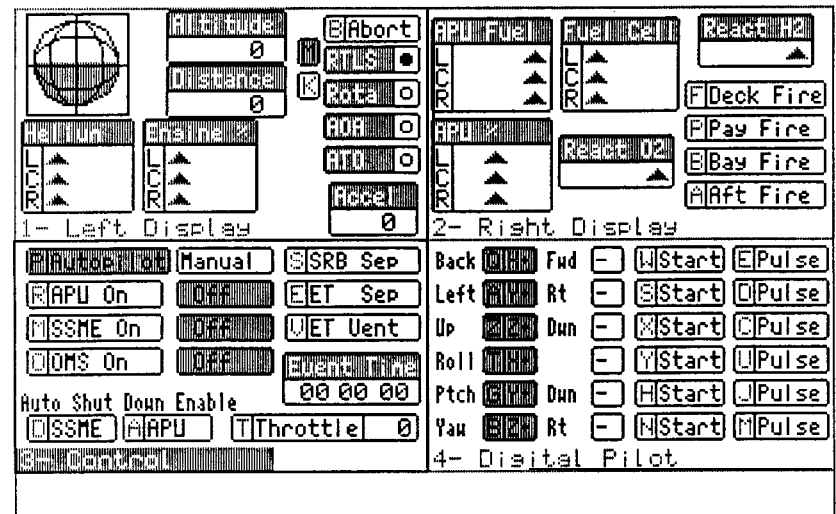

### (Panels Screen)

To display and make a panel operable it must be highlighted (a white border will appear around the panel and the panel title will show as white text on a blue background; or light text on a shaded background if using monochrome). There are two methods used to select panels. 1) Move from one panel to the next, in a clockwise rotation, by pressing the [Tab] key; or, 2) use the numeric keypad keys [Home], [Pg Up], [Pg Dn], or [End]. The position of the key corresponds to the panel location on the screen.

To display a new panel, or to change the position of a panel currently displayed, select the desired quadrant using one of the methods described above and press a function key (F1 through F10) corresponding to the panel you wish to display. The new panel will replace the original selection. During the simulation, the selected panels will remain on the screen until they are changed by the player.

The panels will be described in numerical order (F1 - F10).

### Left Display Panel (F1)

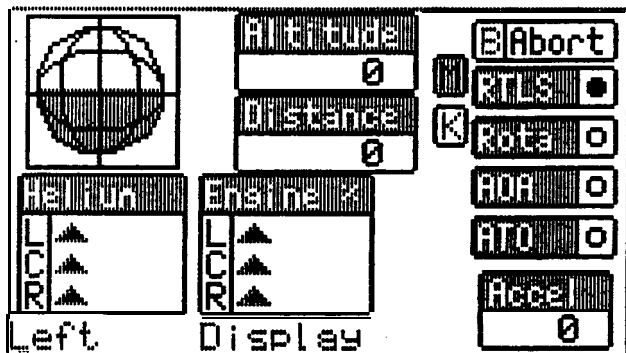

*Artificial Horizon:* (Large sphere on the upper-left)

Shows current Roll position of the shuttle relative to the Earth's surface. Blue on the bottom indicates that the shuttle's wings are level with the ground and the Orbiter is upright in relation to the Earth. Blue on the top indicates the Orbiter is upside down in relation to the Earth.



*Altitude:*

Displays the Orbiter's altitude in selected units (kilometers/meters).



*Distance:*

Displays the Orbiter's distance to the runway during the landing phase (in kilometers/meters).



**MK:**

**[M]** - Button used to display altitude and distance in meters. **[K]** - Button used to display altitude and distance in kilometers. Meter and kilometer settings may also be selected from the Special menu.



*Helium %:*

Shows the percentage (%) of pressure on the OMS engines, Left/Center/Right. The triangular indicators are at 0% when at the far left, and 100% when at the far right.



*Engine %:*

Engine thrust indicator for SSME's or OMS engines, Left/Center/Right, shown in %. The triangular indicators are at 0% when at the far left, and 100% when at the far right.

**Abort:**



**[B]** - Button used to abort a mission during

launch to one of the abort site options. The highlighted options show which site you must choose based on your altitude and distance from the launch pad.

**RTLS** - Return to Launch Site. **Rota** - Abort to Rota, Spain. **AOA** - Abort Once Around. **ATO** - Abort to Orbit.



*Accel:* (Accelerometer)

Measures g-Force (gravities) during acceleration. Each 1,000 unit value is equal to 1 g (9.8 meters/second squared), assuming zero g-force on the launch pad, at rest. A force of 5 g's (5,000) will cause fatal damage to the shuttle.



## Right Display Panel (F2)

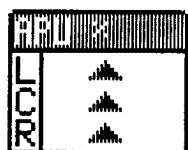
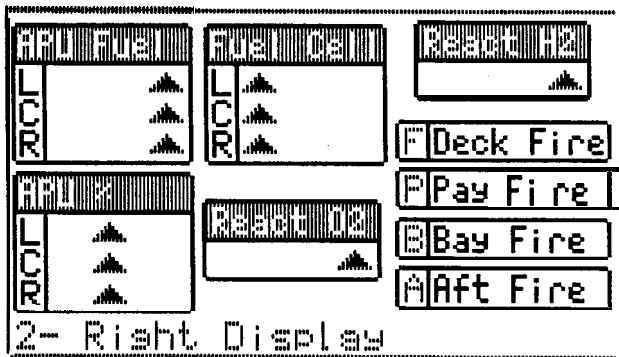

### APU %:

Pressure indicators measured in % for the three Auxiliary Power Unit systems (Left/Center/Right). The triangular indicators are at 0% when at the far left, and 100% when at the far right.



### APU Fuel:

Percentage of fuel left for the three APU fuel tanks. The triangular indicators are at 0% when at the far left, and 100% when at the far right.



### Fuel Cells:

Three Kw (kilowatt) indicators for the three fuel cells of the Electrical Power System. Each can put out between 0 and 8 kilowatts. The triangular indicators are at 0 (off) when at the far left, and 8 (high) when at the far right.

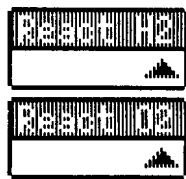

### Reactants - H<sub>2</sub>/O<sub>2</sub>:

Percentage indicators for reactant levels of H<sub>2</sub> (hydrogen) and O<sub>2</sub> (oxygen) used for the SSME's. The triangular indicators are at 0% (empty) when at the far left, and 100% (full) when at the far right. These

indicators may be configured to digital mode (kilogram units) by selecting [D]igital from the *Configuration* option of the Special menu.

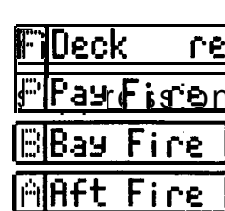

### Fire Suppression Systems:

Buttons to control the various fire systems on the shuttle.

[F] - on the Deck area. [P] - in the Payload area of the bay. [B] - in the Bay. [A] - in the Aft station area.

## The Control Panel (F3)

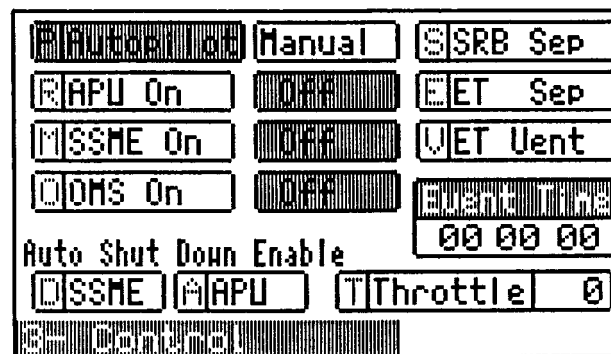

The forward **C**ontrol panel contains the buttons necessary to control the engines and the SRB and ET separations.



### Autopilot/Manual:

[P] - If Autopilot is highlighted this indicates that the Autopilot is flying the Orbiter. If Manual is highlighted this indicates that you are piloting the Orbiter. Toggle button - autopilot/manual.



### APU On/Off:

[R] - Button to start up or shut down Auxiliary Power Units. Toggle button - on/off.

X - Y - Z AXES (Translation/Rotation)

MMU

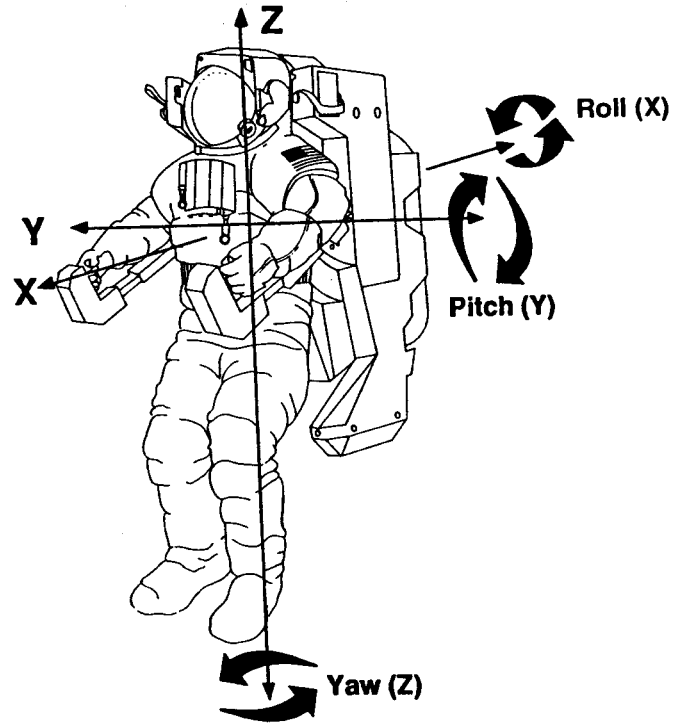

X - Y - Z AXES (Continued)

Arm (RMS)

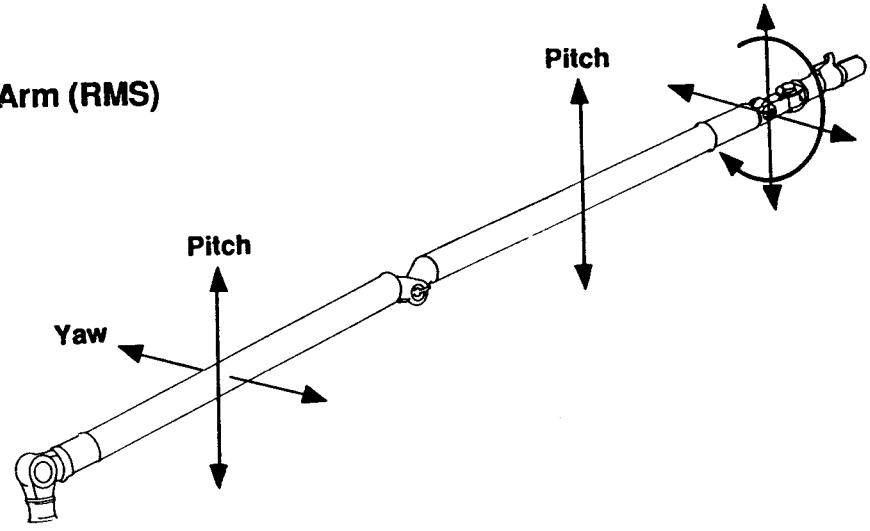

RMin/RMax

Orbiter

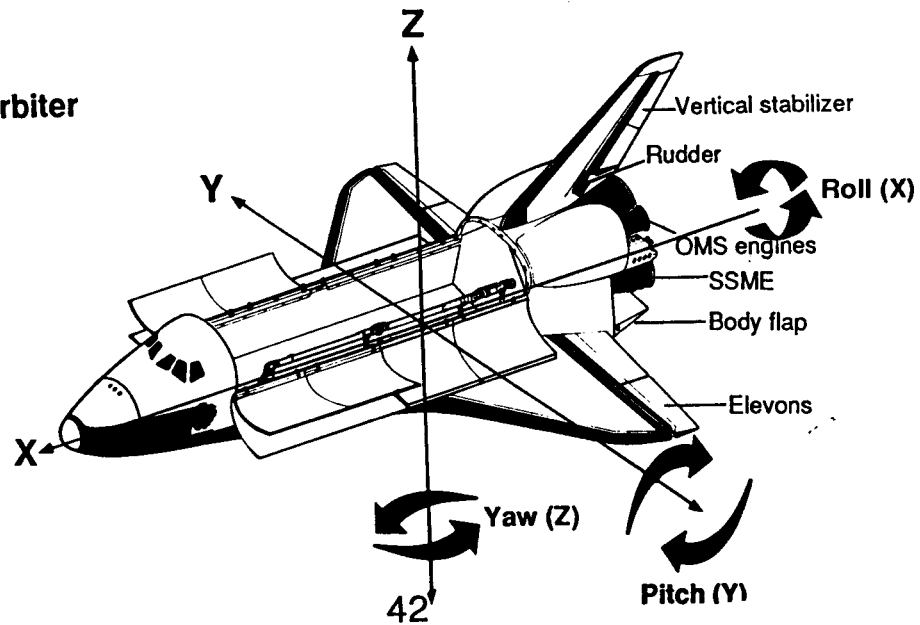

Elliptical Orbit

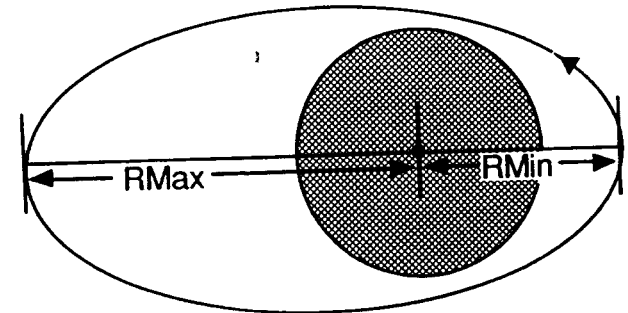

**[M] SSME On**



*SSME On/Off:*

**[M]** - Button to start up or shut down the Space Shuttle Main Engines. Toggle button - on/off.

**[O] OMS On**



*OMS On/Off:*

**[O]** - Button to start up or shut down the Orbital Maneuvering System engines. Toggle button - on/off.

*SRB and ET Sep:*

**[S] SRB Sep**

**[S]** - Manual button for controlling Solid Rocket Booster separation.

**[E] ET Sep**

**[E]** - Manual button for controlling External Tank separation. If highlighted, separation has occurred.

**[V] ET Vent**

**[V]** - Button for the ET vent. If highlighted, this indicates that the ET fuel doors are closed. Toggle button - open/closed.

**Event Time**  
00 00 00

*Event Time:*

Simulation time indicator in hours:minutes:seconds.

**[D] SSME [A] APU**

*Auto Shut-Down Enable:*

Allows the on-board computer to shut down the SSME's **[D]** or APU's **[A]** when a problem is detected.

**[T] Thrott l e | 0**

*Throttle/0:*

**[T]** - Manual button to activate the throttle level control. Toggle button - on/off. **[0]** - Control displaying the percentage of thrust. Once the throttle has been activated enter the desired % and press **[Return]**. Use the keyboard number keys or up or down arrow keys

for higher or lower numbers in single units, or **[Pg Up]** or **[Pg Dn]** keys to achieve maximum or minimum %.

### Digital Pilot Panel (F4)

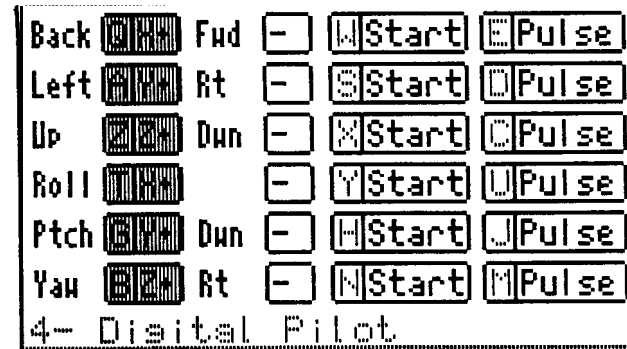

Your ORBITER Glider Kit may help you understand this section. Use it to visualize the descriptions that follow. (See the diagrams on page 42 and 43, and Section 7, Maneuvers and Operations, for a complete explanation of these movements.)

Back Fwd   
Left Rt   
Up Dwn

**TRANSLATION:** movement along the line of one or more of the three axes, X, Y, and Z. **[Q]** moves the Orbiter backward - *Back* (X+), or *Forward* (X-). **[A]** moves the Orbiter to the *Left* (Y+), or *Right* (Y-). **[Z]** moves the Orbiter *Up* (Z+), or *down* (Z-).

Roll   
Ptch Dwn   
Yaw Rt

**ROTATION:** movement around one or more of the three axes. **[T]** counter-clockwise (X+), or clockwise (X-) roll about the Xaxis. **[G]** upward roll (Y+) 0 to 180 degrees, or downward roll (Y-) 0 to -180 degrees, about the Y axis. **[B]** Yaw *Left* (Z+), or *Right* (Z-) about the Zaxis.

**W Start** **E Pulse**

Each direction has a Start button and a Pulse button. Select the direction of your move, then initiate movement by pressing either the start or Pulse button corresponding to the chosen movement. *Start* will burn the thrusters until selected (toggled) again. *Pulse* will burn one short burst, 3 degrees per second.

### The Landing Panel (F5)

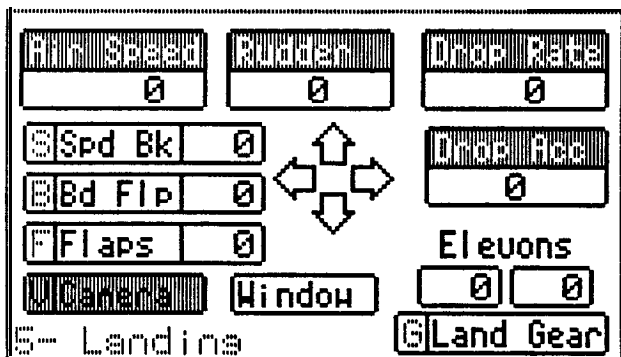

This panel contains the controls necessary for a successful landing.



#### *Air Speed :*

"Inertial" velocity indicator; speed along the flight path in meters per second.



#### *Rudder:*

Rudder indicator in degrees, a zero degree setting indicates that the rudder is centered. May be controlled by using the left or right arrow keys, or by clicking the mouse on the left or right arrows in the panel.



#### *Drop Rate:*

Downward velocity indicator in meters per second. May be affected by up or down pitch maneuvers using the up or down arrow keys, or by clicking the mouse on the up or down arrows in the panel.



#### *Drop Acc:*

Downward acceleration indicator in meters per second. (A minus indicates ascent.) May be affected by up or down pitch maneuvers using the up or down arrow keys, or by clicking the mouse on the up or down arrows in the panel.



#### *Speed Brake/0:*

Aerodynamic brake setting in percentage. 100% is on full stop. Controlled by selecting the [S] key and entering the appropriate number from the numeric keypad, or by using the [+] or [-] keys, or the [Pg Up] or [Pg Dn] keys and then pressing Return or Enter.



#### *Body Flap/0:*

Body Flap control setting in degrees (+30 or -30); a zero degree setting indicates that the flap is neutral. The body flap provides additional lift and drag. It is controlled by selecting the [B] key and entering the appropriate number from the numeric keypad, or by using the [+] or [-] keys, or the [Pg Up] or [Pg Dn] keys and then pressing Return or Enter.

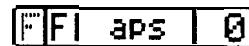

#### *Flaps/0:*

Wing flap control setting in degrees (+30 or -30); a zero degree setting indicates that the flaps are neutral. During final approach, one elevon on each wing is used as a flap. This control displays current position of the flaps and, operated like the body flap, is used to provide additional lift or drag.

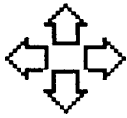

**Four Directional Arrows:** (for the mouse)  
Controls the elevons and flaps during landing. The arrows correspond to Orbiter movement, i.e. pitch up (ascend), down (descend), yaw to the left or right. The open area between the arrows centers the elevons. From the keyboard, use the arrow keys for pitch and yaw and the [+] key to center the elevons.



**Elevons:**

Displays the current position in degrees (+ or - 30), of the elevons, port (left) and starboard (right). The elevons are controlled using the Four Directional Arrows.



**Land Gear:**

The landing gear can only be lowered [G], not raised. When selected, the button will highlight indicating that the landing gear is down.



**Camera:**

Shows the landing site, as if a swivel camera were mounted under the fuselage.



**Window:** Front window view of landing

**Payload Bay Panel (F6)**

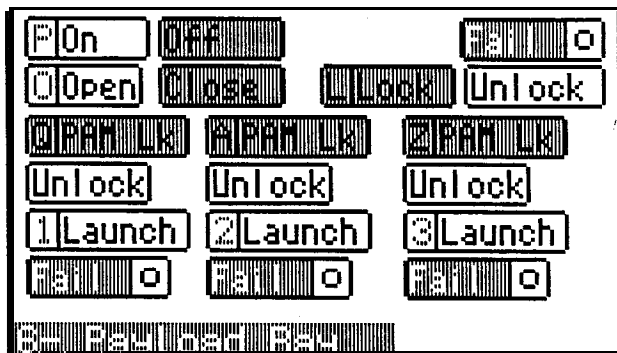

This panel is used to control the Bay Doors and to launch objects using the Payload Assist Modules (PAM's).



**Power On/Off:**

[P] - Button to power up or shut down door motors. Toggle button - on/off.



**Fail:**

Malfunction Indicator for the bay door mechanism.



**Doors Open/Close-Lock/Unlock:**

[O] - Button which opens or shuts the bay doors. Toggle button - open/close. [L] - Button to lock or



unlock the doors in the selected position. Toggle button - lock/unlock



**PAM's Lock/Unlock: (slots 1, 2 and 3)**

[Q], [A], [Z] - Buttons to secure or release an object from the holding clamps in the assigned bay (1,2, or 3). Toggle buttons - lock/unlock.



[1], [2], [3] - Buttons used to launch a payload from the assigned bay into space.



**Fail:** Indicators to show that a malfunction has occurred with a particular payload.

**The Engines Panel (F7)**

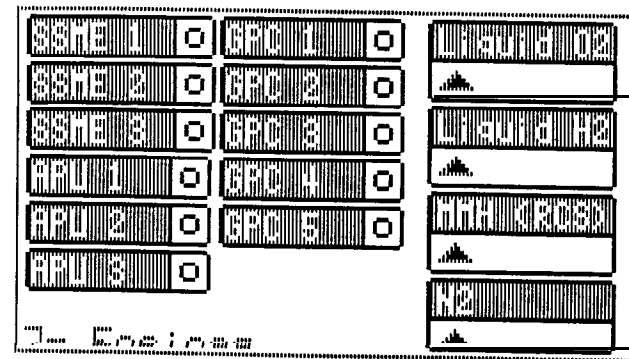

The Engines panel contains the engine status displays.

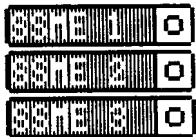

### SSME 1,2,3:

Status indicators for the SSME's. If a circle is highlighted, a failure has occurred and you must watch the Message CRT for updates.

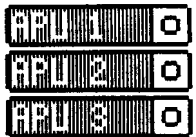

### APU 1,2,3:

Status indicator for the APU functions. If a circle is highlighted, a failure has occurred and you must watch the Message CRT for updates.

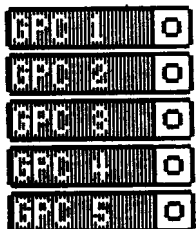

### GPC 1,2,3,4,5:

Status indicators for the **on-board** General Purpose Computers. If a **circle is** highlighted, a failure has occurred and you must watch the Message CRT for updates.

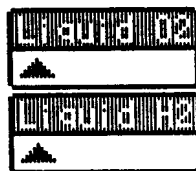

### Liquid O2 and H2:

Liquid Oxygen, Liquid Hydroxide (Propellant for SSME's) percentage indicators. The triangular indicators are at 0% (empty) when at the far left, and 100%

(full) when at the far right. These indicators may be changed to a digital read-out (in kilograms) by selecting [D]igital from the *Configuration* option of the **Special** menu.



### MMH and N2:

Monomethyl Hydrozene, Nitrogen tetroxide (Propellant for RCS system) percentage indicators. The triangular indicators are at 0% (empty) when at the

far left, and 100% (full) when at the far right. These

indicators may be changed to a digital read-out (in kilograms) by selecting [D]igital from the *Configuration* option of the **Special** menu.

### Test Weapons Panel (F8)

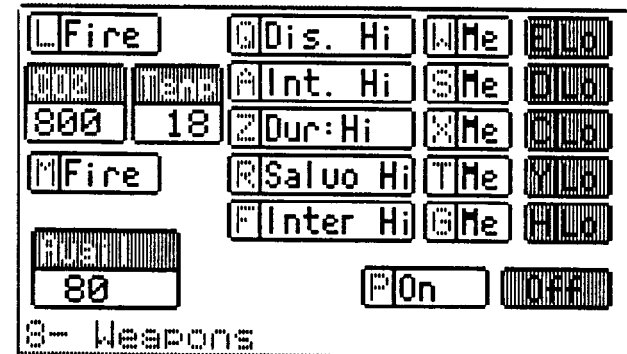

The Test Weapons panel was included for use with game scenarios which may be developed at a later date. The weapons are simulations of electronic devices which indicate if your target is within range and if your shot would have hit or missed the target. You will not be able to destroy any objects with these weapons.

### LASERS:

**[L]Fire** - Fires the laser at the object sited in the window using the selected weapon values.



Dispersion (width of beam)  
[Q] High, [W] Medium, or  
[E] Low.



Intensity (power of beam)  
[A] High, [S] Medium, or [D]  
Low.

**[Z] Dur: Hi** **[X] Me** **[C] Low**

Duration (pulse time) - [Z] High, [X] Medium, [C] Low.

**co2:**  
**800**

Carbon dioxide is the "fuel" for this type of laser. Quantity depends upon original load and Player's firing methods.

**Temp:**  
**18**

Temperature of the laser system in degrees Celsius.

### MISSILES:

**[M] Fire** - Fires your missile selection at the target shown in your window.

**[R] Salvo Hi** **[T] Me** **[Y] Low**

Salvo Size (number of missiles fired in succession) - [R] High, [T] Medium, [Y] Low.

**[F] Inter Hi** **[G] Me** **[H] Low**

Interval (length of time between salvo discharge) - [F] High, [G] Medium, [H] Low.

**Avail:**  
**80**

A vail :  
Number of missiles left.

**[P] On** **[P] Off**

Power On/Off:  
[P] Button used to turn on or shutdown the Missile and Laser power. Toggle button - on/off.

### RMS Panel (F9)

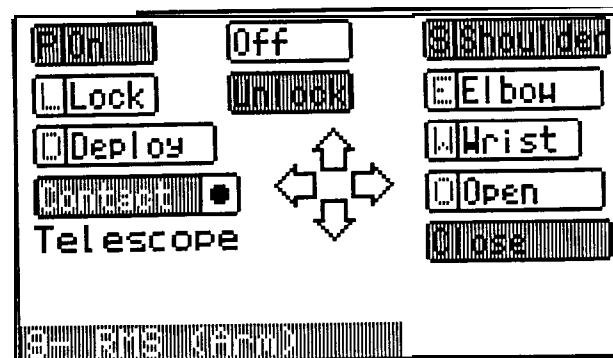

This Panel is for controlling the Remote Manipulator System (RMS), better known as the "Arm." Display the Aft window panel when using the RMS in order to watch its movements from the Bay.

**[P] On** **[P] Off**

Off

Power On/Off:

[P] - Button used to power up or shut down power to the RMS. Toggle button - on/off.

**[L] Lock** **[L] Unlock**

Lock

ARM Lock/Unlock:

[L] - Button used to lock or unlock the Arm before and after maneuvers. Toggle button - lock/unlock.

**[D] Deploy**

[D] - Button used to launch an object from the bay. Once an object is grasped and is unlocked from the payload slot, it may be deployed by using the Arm instead of the payload launch facility.

**Tel escope** **•**

Contact:

Indicator showing that the arm has made contact with an object in the payload bay or space. The name of the object in contact will appear below this box.

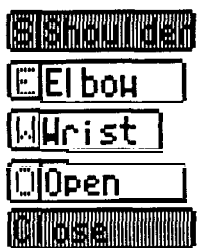

#### ARM Joints:

[S] - Button used to activate the shoulder.

[E] Button to activate the elbow [W]

Button to activate the wrist. [O] - Button to open or close the hand at the end of the wrist joint so that an object may be grasped and secured, or released.

Toggle button - open/close.



#### Movement Arrows: (mouse controls)

"Buttons" used to rotate the selected joint (shoulder, elbow, wrist) in the desired direction. The up and down arrows represent Pitch movement. The left and

right arrows represent yaw movement. Select an RMS joint and rotate it using the arrow keys from the keyboard or by clicking the mouse on the desired arrow in the panel.

The shoulder can pitch and yaw; the elbow can only pitch, and the wrist can roll, pitch and yaw. (See diagram on page 45.)

To perform a roll maneuver, select the wrist [W] and use the [+] or [-] keys from the keyboard. The [+] key will roll the wrist to the left; the [-] key will roll it to the right.

**Note:** detailed explanation of the Remote Manipulator System (RMS) is provided in Section 7. Maneuvers and Operations.

## Forward and Aft Window Panels (F10)

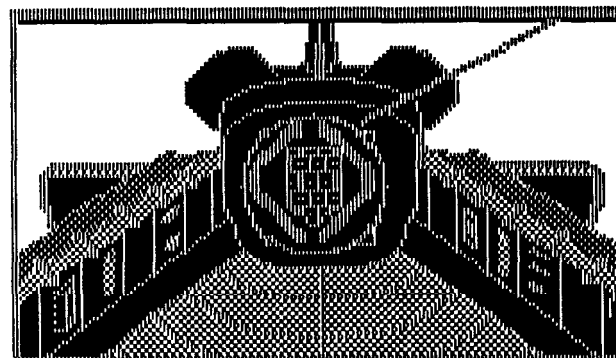

### (Aft Window)

To see out the Forward window you must have passed SRB separation and have the Forward view selected from the **Views** menu, or use the keyboard equivalents, the [Alt] and [1] keys pressed simultaneously. Select a panel, then press the [F10] key and the Forward window will appear.

In order to see out the Aft windows you must be in a stable orbit and the bay doors must be opened. Select *Aft* from the **Views** menu, or use the keyboard equivalents, the [AH] and [2] keys pressed simultaneously. The Aft window will give a view of the Payload Bay and whatever is in space around the Orbiter.

Objects to be seen may include the sun, Earth, stars, the moon, and man-made objects such as the space station or a satellite or two.



## MMU (Manned Maneuvering Unit)

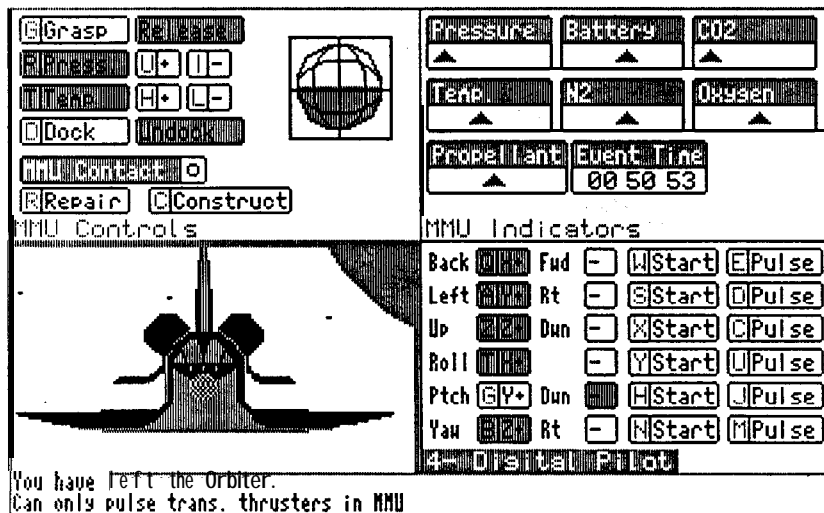

The panels for the MMU may not be changed. You may view any of the CRT screens while in the MMU.

### MMU Controls Panel:



#### Grasp/Release:

[G] - Button used to grasp onto an object if it is within reach (2 meters). Once grasped, it is secured to the MMU. Toggle button - grasp/release.



#### MMU Contact:

Indicator. When lit, you have grasped an object and it is attached to the MMU.



#### Press:

[P] - Button used to stabilize the suit pressure at the selected setting. [U] + Increases suit pressure. [U] - Decreases suit pressure. Toggle buttons - on/off. See MMU Indicators Panel.



[T] - Button used to stabilize the suit temperature at the selected setting. [H] + Increases suit temperature. [L] - Decreases suit temperature. Toggle buttons - on/off. See MMU Indicators Panel.



#### Dock/Undock:

[D] Button to dock or undock with the Orbiter. Docking may occur if the MMU is within range of the bay (up to 9 meters). Undocking releases and ejects the MMU from the Orbiter 3 meters above the shuttle and facing in the same direction. Toggle button - dock/undock.



#### Repair:

[R] - Button used to repair an object. The object must be within 2 meters of the MMU.



#### Construct:

[C] - If one object is grasped and another is within range, they may be attached to each other by selecting the Construct button.

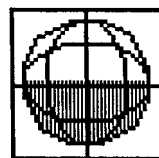

#### Artificial Horizon:

When the MMU performs Roll maneuvers using the Digital Pilot [T], the roll is depicted on this indicator. The (X+) rolls counter-clockwise, and the (X-) rolls clockwise.

### MMU Indicators Panel:

Battery, Nitrogen (N2) Oxygen, Propellant, and Carbon Dioxide (CO2): Resource status indicators in percent remaining. Display in Digital or Analog mode.



*Pressure:*

Suit pressure indicator measured in millibars. Digital or Analog.



*Temp:*

Suit temperature indicator measured in degrees Fahrenheit. Digital or Analog.



*Event Time:*

Total simulation time in hours, minutes and seconds. (Also displayed on the CRT screen.)

**MMU Digital Pilot Panel:**

See the Panel Screen Section, (pages 45 and 46) and MMU Maneuvers information (pages 65 and 66 ) for Digital Pilot operating information.

Please note that the MMU can Start and Pulse the Rotational thrusters, but can only Pulse the Translational thrusters.

**MMU Window Panel:**

You may see any of several objects from the window including the Earth (the largest of the objects), the moon, stars, satellites and other man-made objects. Your view from the spacesuit helmet displays as a window in the lower left-hand quadrant and may show any of the above objects, plus the Orbiter from 6 different viewing directions (see page 74 and 75, Object Identification). If an object is locked in the Bay when you undock, the object will not be visible from the MMU.

**CRT SCREENS**

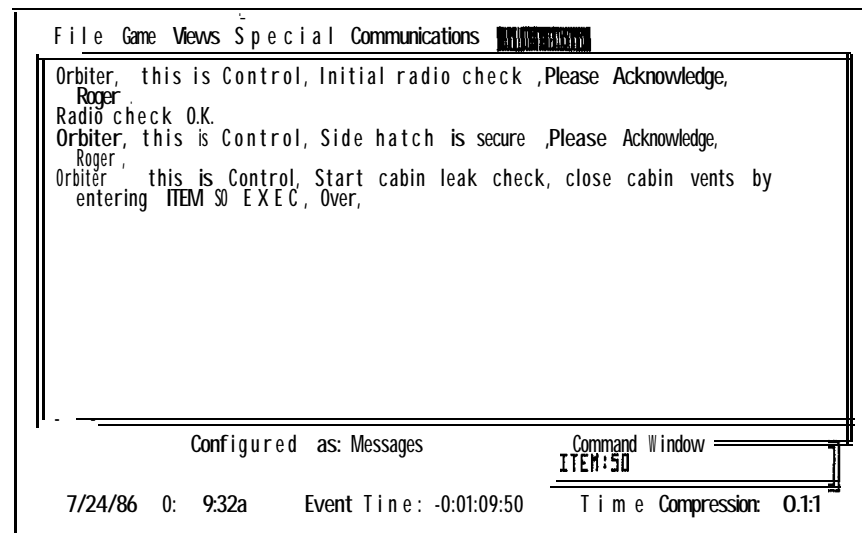

**(Message CRT)**

ORBITER has a total of seven CRT displays (Cathode Ray Tubes), five of which may be displayed during any one phase of the mission.

**Radio Log (F1)** displays all messages previously received from Mission Control.

**Messages (F2)** displays textual information regarding Mission Controls instructions and instructions or warnings from the on-board computers. This option is used most frequently during launch and landing phases.

**Launch/Pam Display/Landing (F3)\***

**Orbital Info (F4)** provides RMin, RMax, Velocity, Angle, Distance and Identification information on selected man-made orbiting objects. You will use this CRT to select objects with which to match orbits, or display current information in conjunction with the Orbiter or MMU infor-

mation on the Status display. To select an object status line use the [Pg Up] or [Pg Dn] keys until the desired line highlights. The selected object's orbital information will now be made available on the Status display below the Orbiter or MMU Information line. Also, the selected object is now available for matching orbits using the Spec 99 Pro command described in Section 7, Maneuvers and operations.

**Status Display (F5)** provides the orbital statistics of the shuttle or the MMU. These include: Radius Minimum/Radius Maximum (see page 43), Altitude, Angle of Attack (AA), Velocity, Acceleration, Longitude, Latitude, Orbital

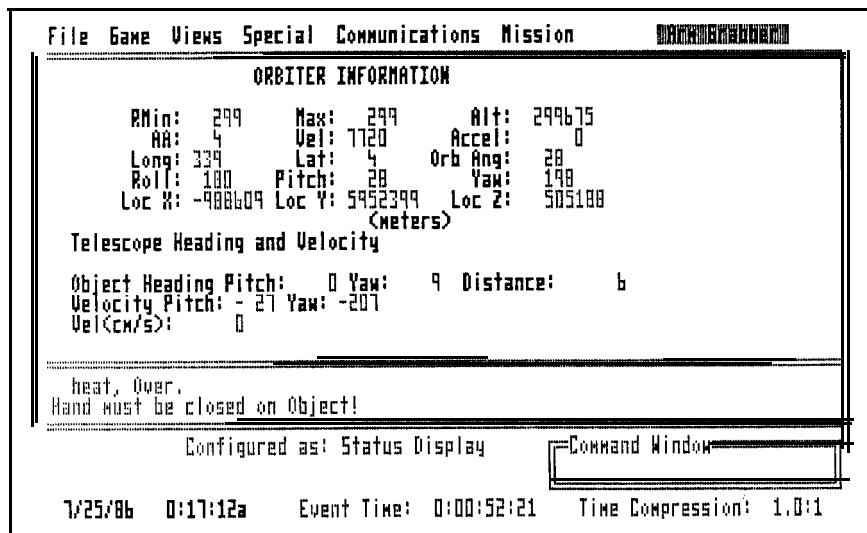

**(Status Display CRT)**

Angle, Roll, Pitch and Yaw, and your location plotted in X, Y, and Z coordinates. This display will be used most frequently during in-space activities. Some information is self-explanatory. To understand the read-outs more fully, refer to Section 7, Maneuvers and Operations.

. **(F3)** - The **Launch Trajectory, Pam Display, and Landing Display** options are available only during their respective activities.

The Launch CRT will show a plotted trajectory of your launch and includes the target altitude for your orbit as well as the SRB and ET separation points. It will also show launch deviations should you encounter certain failures before reaching ET separation. After ET separation this CRT option is no longer available and reverts to PAM Display.

The PAM Display provides information about cargo to be launched from the Payload Bay. The content of each of the three bays is listed. The Target Radius - the altitude at which you are instructed to launch the object or at which its own motors will bring it to the proper orbit - and your Present Radius are listed. (The latter figure will match your current Rmax read-out.)

The Landing CRT is available once through the re-entry communications blackout. A landing representation, similar to the Launch Trajectory, gives information regarding your course, heading, and distance from the runway. (See the landing section of the "Walk-Through" for more detailed information).

## 7. Maneuvers and Operations

The following is a guide to help you maneuver the Orbiter, the MMU and the RMS with relative ease. In order to visualize the orbital maneuvers of the Space Shuttle system, put together your paper Orbiter model included in the program package. The model will help you relate three dimensional movement to the two dimensional illustrations shown in the manual on pages 42 and 43. It may also help to refer to the previous section, ORBITER Panels and CRT Screens.

### Some general laws of motion in space:

Maneuvering vehicles in space is not the same as operating a vehicle on the Earth. In space, up and down is relative to the object you are in (MMU, Orbiter). Think of yourself in space with no large object with which to orient yourself, which way is up? Up is the direction away from the bottom of your vehicle. Also, inertia is operative in space, i.e., once an object is moving in space it will continue in the same direction and at the same velocity, unless acted upon by another force, because there is no friction to create "drag." Objects may collide with one another causing a transfer of energy; or they may be affected by the earth's "gravity well," which is why objects remain in orbit instead of flying off into space.

Also remember that you are traveling in a circle. An object may be straight ahead, but your path to get to it will be an arc. You may want to use your model in conjunction with a large ball to appreciate the movements necessary to reach another object along a curved route.

Shuttle motion is described in terms of the X, Y, and Z axes. The X axis describes an imaginary line running through the shuttle from the tail to the nose. The Y axis

describes an imaginary line from wing to wing. The Z axis describes an imaginary line through the center of the shuttle from the belly through the top. (See the illustration on page 42.)

**Translation** is a sliding movement along one or more of the three axes.

**Rotation** is movement around one or more of the three axes.

**Pitch** is rotation about the Y axis.

**Roll** is rotation about the X axis.

**Yaw** is rotation about the Z axis.

### Orbital Operations

Most orbital operations are performed from the **Digital Pilot** panel. This section will provide more detail on the maneuvers controlled from this panel.

The Start buttons are toggle switches, i.e, select once and they will burn until selected again. The Pulse buttons will fire a short spurt, then stop.

Orbits are either circular or elliptical paths around the Earth as measured by Rmin (Radius minimum), Rmax (Radius maximum), and Angle. **Rmin** is the closest end-point of an object's elliptical orbit and the location of the orbiting object's highest velocity. **Rmax** is the farthest end-point of an object's elliptical orbit and the location of the orbiting object's lowest velocity. (See diagram on page 43.) When the Rmax and Rmin are equal, you have a circular orbit.

**Angle** refers to the angle made when the path of an object in orbit crosses the equator.

The two terms used when discussing orbital maneuvering are Matching and Adjusting.

**Matching** is the process of changing the shuttle's orbit to "match" another object's orbit to within several meters. It may be necessary to perform translation and rotation movements in order to match another object's orbit. (For aid in identifying objects seen from the shuttle window see Section 9, Object Identification.)

The Item 99 Exec [199E] keyboard command is used to perform the matching function with an object that has been selected from the CRT screen configured to Orbital. The object must be in *Low Orbit*. The computer will advance your orbit, burn fuel, and adjust the clock to reflect the event time required to match the selected object. Orbital angle can only be changed by 2 degrees each time you change your orbit (ORBITER measures angle in 10th's of a degree and rounds this out to the nearest whole number).

**Adjusting** an orbit means to adjust Rmin or Rmax. Adjusting Rmin or Rmax requires time and patience. To effect a change in Rmin you should fire the OMS engines at Rmax. To effect a change in Rmax you should fire the OMS engines at Rmin.

To increase Rmax, face toward velocity and burn at Rmin.  
To decrease Rmax, face against velocity and burn at Rmin.  
To increase Rmin, face toward velocity and burn at Rmax.  
To decrease Rmin, face against velocity and burn at Rmax.  
(These changes are made using **Item-Exec** keyboard commands. See Section 8. Keyboard Equivalents and GPC Commands.)

Follow Rmin, Rmax and Angle on a CRT screen configured for *Status* or *Orbital*. It is, for all intents and purposes in

this program, impossible to manually change your orbital angle. The physics involved are considerable.

## Manned Maneuvering Unit (MMU)

The basic operating elements of the MMU are docking and undocking, maneuvering, grasping and releasing, and constructing and repairing. To operate the MMU select *MMU* from the **Views** menu. Four non-changeable panels will be displayed: a window; the MMU Indicators; MMU Controls; and Digital Pilot panels. Time compression will remain at 1 .1 while in the MMU to simulate a true EVA.

### MMU Maneuvers:

Movement is described in terms of Translation and Rotation as it is with the Orbiter (see diagram on page 42). In the MMU you may only pulse the thrusters if you are performing translational maneuvers (see the top three choices [Q], [A], [Z]). These short bursts keep you from

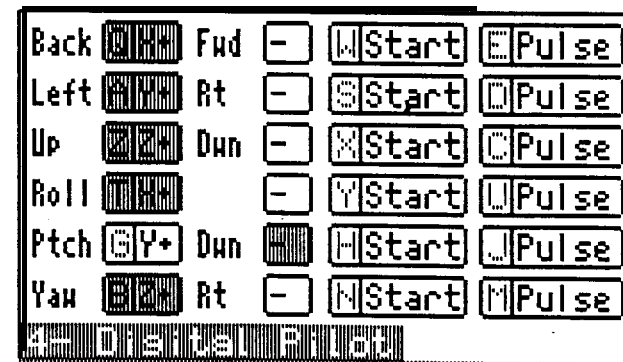

(MMU Digital Pilot Panel)

moving too far from the shuttle. To move along the X axis (face-forward), select [Q] so that Fwd (-) will be highlighted and then press [E] to pulse. Select Back [Q] (X+) to move backwards. The Yaxis [A] controls sideways movement

while the Z axis [Z] controls straight up and down movement.

Rotational maneuvers will cause you to “pivot” about the axis while remaining in the same relative position. For rotational movements you may use both the pulse and continuous thrusters. When you perform pitch and yaw maneuvers you will be able to see your motion relative to the objects in the MMU window. To see the roll maneuver, look at the artificial horizon indicator in the MMU Control panel.

From the MMU window you will be able to see the shuttle from 6 different positions, front, back, 2 sides (including upside-down), top and bottom (see page 75). Because the number of views are limited and the objects are 2-D, the shuttle will “flip” to another view at certain preselected points along the shuttle image, sometimes giving the impression that you are not going where you had intended. It takes a great deal of skill to maneuver completely around the shuttle, but the views are worth the effort.

#### **Dock/Undock:**

When Undock [D] is selected from the MMU Controls panel the MMU is propelled into space approximately three meters above the cargo bay and facing in the same direction as the Orbiter. While out in the MMU only the MMU view will be available to you. When ready to return to the safety of the Orbiter, maneuver to within nine meters of the bay and press [D] again to dock. Once docked, you are able to control the Orbiter and make another selection from the **Views** menu.

#### **Grasp/Repair/Release:**

Capturing an object requires that you maneuver to the desired object to within 2 meters and select Grasp [G] from the **MMU Controls** panel. Several attempts are allowed.

The chances for a successful capture are increased if the object is centered in the window, has the same movement as the MMU and is not rotating. Once an object is attached to the MMU it is eligible for Construction [C], or Repair [R]. When the object has been grasped the MMU may still be moved, but with degraded performance.

Repairs may be effected while the object is grasped or within two meters of the MMU. Several tries may be needed to complete the repair, if the object is indeed repairable. Let go of the object by pressing Release [G].

If your instructions are to secure the object in the cargo bay, or if the object is not repairable and it must be returned to Earth, it may be necessary to use the **MMU Matcher** described in the next paragraph.

#### **MMU Matcher Menu:**

When you have undocked you will notice this new item appearing on the menu bar. This tool is provided to aid you in your attempts to match orbits with another object. The MMU Matcher functions as the Item-99-Exec command does on the Orbiter, but is limited to a distance of 2,000 meters. It is best to get as close to the object as possible in the Orbiter and then use the MMU Matcher to get within grasping distance.

The highlighted options on this menu are within matching distance of the MMU. Once an object has been captured you may release it into one of the 3 payload slots by selecting the desired slot from the list at the bottom of the menu. (See page 35 in the ORBITER Pull-Down Menus section.)

Secure a captured object in the cargo bay by first selecting the desired payload slot from the **MMU Matcher** menu

then releasing the object. The object will automatically lock into that bay slot. To verify that the object is locked in position, dock and pull up the *PAM Display* CRT. If the payload slot shows the name of the object then it is secured.

### **Construction:**

The construction process involves putting two objects together in space. Join the pieces using the construct button [C] when the objects are within two meters of one another.

### **Remote Manipulator System (RMS)**

You may engage the Remote Manipulator System (RMS), once the bay doors have been opened and you are operating from the **Aft** view. You will see the Arm as you look through the Aft window, it will be locked on the right-hand wall of the bay (long red line). Select and display the **Arm** panel [F9] in the desired quadrant. Turn the *Power* on [P], then select unlock [L] to release it from the side of the bay.

The RMS is a mechanical arm with joints and segments resembling the human arm. Each movement of the RMS requires a discrete step. You must first select the joint to be operated (shoulder, elbow, or wrist) and then use the arrow keys, or click the mouse on the desired arrows in the panel, to instigate rotation of the selected joint. Use the [+] or [-] keys to roll the wrist to the left or right respectively. One or two motions may not be available for a particular joint. The Shoulder is able to pitch (up or down), and yaw (left or right); the Elbow can only pitch (up or down); and the Wrist can roll (left or right), pitch (up or down), and yaw (left or right). See the diagram of the RMS on page 43.

### **Arm Grabber Menu:**

Objects in orbit will be highlighted on this menu only if they are within reach of the arm. By selecting an object that is within range you will automatically send the Arm over to grasp it. An object is in range if it is within approximately 20 meters of the Orbiter.

If an object is in the bay, select it from the Arm Grabber menu and then launch it using the Deploy [D] button from the RMS panel. (Be sure to first unlock the object from the assigned payload slot in the Payload Bay panel [F6].)

To place the object in the cargo bay, select the object from the Arm Grabber menu and then select an empty payload slot from the bottom of the menu. The object will be secured to that bay automatically. Release the object and secure the arm to its position in the bay by selecting *Orbiter* from the Arm Grabber menu, and then locking it into place and shutting down the RMS power, panel [F9].

## 8. Keyboard Equivalents and GPC Commands

### Keyboard Equivalents:

Where applicable, keyboard equivalents are displayed next to an option listed in the pull-down menu. Example: Reaching the Forward window is achieved by selecting Forward from the Views pull-down menu or by simultaneously pressing the **[Alt]** and **[I]** key (01). A Quick Reference Card has also been provided in your ORBITER package for a listing of these commands.

#### Game:

Suspend Alt S  
Continue Alt Q

#### Special:

Switch to km Alt K  
Switch to m Alt K  
Go to Orbit Alt J

#### Mission:

Current Alt M

#### Views:

Forward Alt 1  
Aft Alt 2  
Map Alt 3  
MMU Alt 4  
Low Orbital Alt 5  
High Orbital Alt 6

#### Communications:

Affirmative Alt A  
Negative Alt N

### Mouse Controls:

You will use only the left and right buttons on the mouse. The left button controls all panel buttons and arrows, pull-down menus, and most dialog box buttons. The right button toggles between the Panels and CRT screens.

### GPC Commands:

The operations listed below are performed by entering the General Purpose Computer (GPC) commands on the keyboard. When necessary, ORBITER's on-board computer will prompt you to enter these commands. If you select fewer prompts from the Orbiter Configuration dialog box then many of these commands will be performed auto-

matically. If you select to receive full prompting the on-board computer will prompt you to enter almost all of the commands listed below.

To enter commands using the keyboard type the first letter of the prefix followed by the appropriate numbers and the first letter of the suffix. For example, ITEM-25-EXEC, could be entered from the keyboard as [125E].

### [SPEC-PRO] Key Commands

[S] XX[P]

XX	Indicates	When operable
91	Test Payload Module 1	Orbit
92	Test Payload Module 2	
93	Test Payload Module 3	
99	Special Command	

### [OPS-PRO] Key commands

[O] XX[P]

*Most of these commands are performed by the On-board Computers*

xx	Indicates:
99	Special Command 99
101	Prelaunch to Launch program loaded
102	Launch to SRB Separation loaded
103	SRB Separation to SSME cutoff program loaded
104	SSME cutoff to OMS 1 program loaded
105	OMS 2 Program (program) loaded
106	Orbital insertion and coast Program
301	Prepare for retro-fire
302	Retro-Fire and Pre-entry coast program loaded
303	Pre-entry system check and monitor program loaded
304	Atmospheric entry program loaded
305	Atmospheric flight and landing program loaded



- 601 RTLS abort program loaded
- 602 Glide Option #1 program loaded
- 603 Glide Option #2 program loaded
- 901 Preflight Monitor Program loaded

**[ITEM-EXEC] Key Commands**

[ ] XX[E]

XX	Indicates:	When ope able
24	Roll controls enabled	Deorb it
25	Pitch controls enabled	"
26	Yaw controls enabled	"
28	Oms engines armed and pressurized	"
36	Dumping rest of propellants	"
37	Reaction Control System armed	Orbit
38	Dumping Forward propellants	Deorbi t
39	Start Moving Control surfaces	Launch/de orbit
40	Cancel Moving Control Surfaces	Launch/deo rbit
50	Closing cabin pressure vents	Launch
51	Cabin pressure vents opened	"
52	Helium pressure vents closed	"
53	Helium pressure vents opened	"
55	Setting for APU pre-start	"
56	Cabin relief vents enabled	"
57	Anti-skid system disabled	Deorbi t
58	Anti-skid system enabled	"
59	Disable nose wheel steering	"
60	Enable nose wheel steering	"
61	Disable entry roll mode system	"
62	Enable entry roll mode system	"
63	Set speed brake to manual	"
64	Set speed brake to auto	"
65	Set throttle to manual	"
66	Set throttle to automatic	"
67	Set pitch to manual	"
68	Set pitch to automatic	"

69	Set roll/yaw to manual	"
70	Set roll/yaw to automatic	"
71	Set body flap to manual	"
72	Set body flap to automatic	"
90	Executing Yaw + 90 degrees	Orbit
91	Executing Yaw -90 degrees	"
92	Executing Pitch +90 degrees	"
93	Executing Pitch -90 degrees	"
94	Executing Facing to the direction of velocity (i.e. Speeding up)	"
95	Executing Facing to the opposite direction of velocity (i.e. Slowing down)	"
99	Match orbits command initiated	Orbit

# 9. Object Identification

Full Space Station

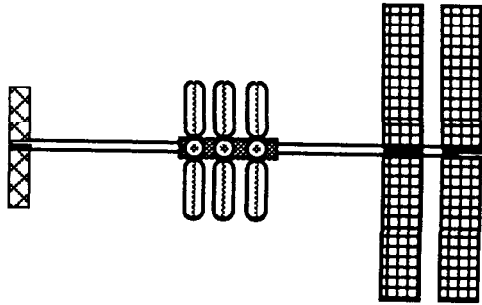

Hughes 376 Series



SBS  
Intelsat 6  
Telstar  
Westar

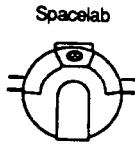

Spacelab

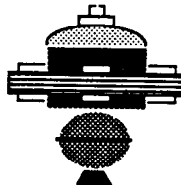

Milsat

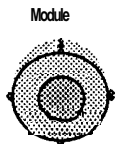

Module



Missiles



Leasat 2



LDEF



Telescope

# Views of the Orbiter from the MMU

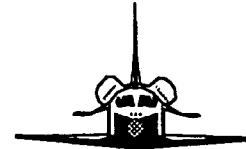

Front



Back

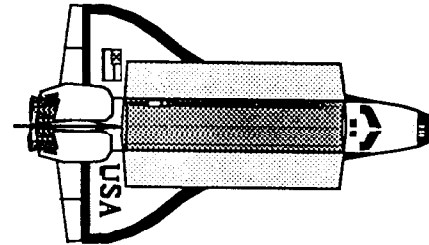

Top

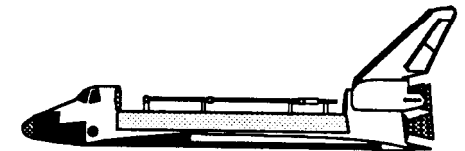

Side(s)

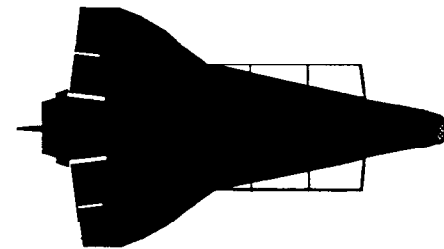

Bottom

## 10. Glossary

**abort** - To end the mission short of its objective. An abort is usually caused by some malfunction or emergency.

**accelerometer** - An instrument that measures the rate at which acceleration changes.

**airlock** - A chamber used to adjust pressure for passage between one area and another; for example, between the Orbiter and the outside space environment.

**apogee** - The farthest point of an Earth orbit (Rmax).

**apogee kick motor** - A rocket motor that fires at the apogee (radius maximum) of an elliptical orbit

**attitude** - The position of the vehicle; for example, flying tail-first with cargo bay toward the Earth.

**avionics** - The electronics systems and instruments to monitor and control the flight.

**blackout** - The loss of radio signal (LOS) during entry caused by passage of the Orbiter through the atmosphere, creating shock waves and ionization. Also, the loss of consciousness from excessive G-Forces.

**cathode-ray tube (CRT)** - A vacuum tube similar to a television tube, on which an electronic beam can draw pictures or write words; used to display computer output.

**deorbit burn** - The firing of a Retro-Rocket to slow the spacecraft to a speed lower than that required to maintain orbit. On the Orbiter, this is accomplished with the orbiter maneuvering system (OMS) engines.

**dock** - To join two spacecraft together in space.

**elevator** - A control surface used once the returning Shuttle has entered the atmosphere; it acts like a combination of an aircraft elevator and aileron, controlling Pitch and Roll.

**extravehicular activity (EVA)** - Work done outside the pressurized part of the spacecraft; a spacesuit must be worn.

**flare** - A pitch-up (nose-up) maneuver that reduces speed for landing.

**fuel cell** - A device that mixes oxygen and hydrogen together in a controlled process to produce electricity and pure water.

**g** - The symbol for the force equivalent to the acceleration of Earth gravity. (32 ft. per second squared = 1 g.)

**g-force** - Force produced on the body by changes in velocity; measured in increments of Earth gravity.

**geostationary or geosynchronous orbit** - An orbit 22,300 miles (35,900 kilometers) from Earth, where the orbital period is 24 hours long. A spacecraft in such an orbit hovers over the equator and seems to be always in the same place in the sky. This is especially important for communication satellites.

**gimbal** - An attachment with hinges or ball joints to permit movement in two or three axes. Rocket nozzles are gimbaled to allow thrust in different directions for flight control.

**glidescope** - The angle at which you descend in the Orbiter or other glider with respect to the ground.

**hypersonic** - Refers to speed above Mach 5 (Five times the speed of sound).

**inertia** - The tendency of a body at rest to stay at rest and a body in motion to continue in motion in the same direction.

**knot** - One nautical mile per hour ; 1 nautical mile equals approximately 1.1 statute (land) miles.

**KU-Band** - Navigation and communication device used for rendezvous and maneuvering. Range = 100 km.

**lithium hydroxide** - A chemical compound (LiOH) used to remove carbon dioxide from the cabin atmosphere.

**Mach** - The term used to describe the speed of objects relative to the speed of sound (1,085 fps, or 740 mph). For example, Mach 2 is twice the speed of sound.

**microgravity** - The term used to describe weightlessness and fractional g-forces produced in orbit. In orbit, you essentially fall around the Earth, producing a "floating" condition.

**micrometeoroids** - Meteoric particles the size of grains of salt. They are plentiful in space and potentially dangerous due to the velocities involved. The spacecraft can be shielded by a barrier equivalent to a thin sheet of aluminum.

**microprocessor** - A small computer that usually performs only a few specific tasks.

**orbit** - A balance between a body's inertia, or tendency to fly off into space, and the gravitational attraction of a central object.

**partial pressure** - In a container of mixed gases (like the shuttle cabin filled with an oxygen-nitrogen mix), each gas exerts a fraction of the total pressure. This *partial pressure* is proportionate to the amount of each gas in the mixture.

**pitch** - Up-down rotation of the nose of the craft (see Roll and Yaw).

**pounds per square inch (psi)** - A measure of pressure. The metric measure is kilopascals. 1 psi X 6.895 = 1 kilopascal of 14.7 psi at sea level.

**retro-fire** - To fire engines in the direction of motion in order to reduce forward velocity. In orbit, this permits gravity to pull you downward.

**retrorocket** - A rocket that fires against the direction of motion, slowing the craft. Gravity pulls the craft downward.

**rocket engine** - An engine that carries its own oxidizer and fuel for combustion and, therefore, is self-contained.

**roll** - To rotate about the X axis, an imaginary line running through the body of the object from front to back.

**rotation** - Movement of the Orbiter *around* one or more of its three principal axes creating Pitch, Roll and Yaw.

**rudder** - A control surface on the vertical stabilizer (tail) to control Yaw.

**software** - Computer programming or instructions.

**speed brake** - The rudder on the Orbiter when it is split and spread to increase atmospheric drag and slow the craft during descent and landing.

**telemetry** - Data transmitted to the Earth regarding the Orbiter, crew and experiments.

**thrust** - The force created by a rocket engine.

**transfer orbit** - An oval shaped (elliptical) orbit made when changing from one nearly circular orbit to another.

**translation** - Movement of the Orbiter along one or more of its principal axes.

**umbilical** - A connecting cable that carries electricity and life support to an astronaut during extravehicular activity.

**vernier engine** - A small thruster for precise adjustments in the Orbiter position.

**vertical stabilizer** - The tail-piece of the aircraft containing the rudder and the speed brake.

**weightlessness** - See microgravity.

**yaw** - Left-right rotation of the nose of the craft (see Pitch and Roll).

## 11. Acronyms

<b>ADI</b>	Attitude Direction Indicator
<b>AG</b>	Air-to-Ground
<b>AMI</b>	Alpha/Mach Indicator
<b>APU</b>	Auxiliary Power Unit
<b>ATU</b>	Audio Terminal Unit
<b>AVI</b>	Altitude/Vertical Velocity Indicator
<b>CFES</b>	Continuous Flow Electrophoreses System
<b>css</b>	Control Stick Steering
<b>DCM</b>	Displays and Controls Module
<b>DOD</b>	Department of Defense
<b>EAFB</b>	Edwards Air Force Base
<b>EMK</b>	Emergency Medical Kit
<b>EMU</b>	Extravehicular Mobility Unit
<b>ERBS</b>	Earth Radiation Budget Satellite
<b>ET</b>	External Tank
<b>EVA</b>	Extravehicular Activity
<b>FRCS</b>	Forward Reaction Control System
<b>GMT</b>	Greenwich Mean Time
<b>GPC</b>	General Purpose Computers
<b>GSFC</b>	NASA Goddard Space Flight Center
<b>HAL/S</b>	High order Assembly Language/Shuttle
<b>HSI</b>	Horizontal Situation Indicator
<b>HRSI</b>	High temperature Reusable Surface Insulation
<b>IUS</b>	Inertial Upper Stage
<b>IVA</b>	IntraVehicular Activity
<b>KSC</b>	Kennedy Space Center
<b>LCC</b>	Launch Control Center (KSC)
<b>LDEF</b>	Long-Duration Exposure Facility
<b>LED</b>	Light Emitting Diode
<b>LFC</b>	Large Format Camera (IMAX)
<b>LOS</b>	Loss Of Signal
<b>LRSI</b>	Low temperature Reusable Surface Insulation
<b>MAPS</b>	Measurement of Air Pollution (aerial camera)
<b>MBK</b>	Medications-and-Bandage Kit
<b>MCC</b>	Mission Control Center

**MCC/H** Mission Control Center at Houston  
**MET** Mission-Elapsed Time  
**MLP** Mobile Launcher Platform  
**MMS** Multimission Modular Spacecraft  
**MMU** Manned Maneuvering Unit  
**OMS** Orbital Maneuvering System  
**OPF** Orbiter Processing Facility  
**ORS** Orbital Refueling System  
**PAM** Payload Assist Module  
**PLBD** PayLoad Bay Door  
**PLSS** Portable Life-Support System  
**POCC** Payload Operations Control Center (Goddard)  
**POS** Portable Oxygen System  
**RCC** Reinforced Carbon Carbon  
**RCS** Reaction Control System  
**RHC** Rotational Hand Controller  
**RMS** Remote Manipulator System  
**RSS** Rotating Service Structure  
**SCA** Shuttle Carrier Aircraft  
**SCAPE** Self-Contained Atmospheric Pressure Ensemble  
**SIR-B** Shuttle Imaging Radar - B  
**SOMS** Shuttle Orbiter Medical System  
**SRB** Solid Rocket Booster  
**SSME** Space Shuttle Main Engine  
**SSIP** Shuttle Student Involvement Project  
**ssus** Spinning Solid Upper Stage  
**STS** Space Transportation System  
**tacan** Tactical air navigation  
**TAEM** Terminal Area Energy Management  
**TDRS** Tracking and Data Relay Satellite  
**TPAD** Trunnion Pin Acquisition Device  
**TPS** Thermal Protection System  
**VAB** Vehicle Assembly Building  
**VAFB** Vandenberg Air Force Base  
**WCS** Waste Collection System  
**ws** White Sands -Northrup Strip- New Mexico

## 12. ORBITER OPERATING INFORMATION

Thank you for purchasing ORBITER. This is truly a powerful simulation and we are very proud to have been able to produce it for you.

ORBITER takes your computer to its limits in computational power and speed. Because of the program's sophistication you may notice a slower response time from systems which do not have high-speed processors. For this reason we have included a "Time Compression" feature which allows you to speed up the simulation time. The keyboard response time will not be affected by the time compression feature and will pause while the program is processing your input. A high-pitched beep will be heard for each keyboard or mouse command input to let you know that your selection has been accepted and will be processed when time becomes available.

As microcomputers become more powerful, so must the software. You are the owner of the most high-powered entertainment and educational simulation package to be produced for the IBM personal computer to date...ORBITER.

---

HICARD RAM CARDS for \$69.00 - While supplies last.

Spectrum HoloByte is pleased to announce the availability of the HiCard: an add-on RAM board and print spooler with software for the IBM PC and true compatibles. The HiCard will allow your ORBITER and other programs to run more quickly by eliminating frequent disk drive access. The software and board (without memory chips) retails for \$119.00, but is yours for just \$69.00 with proof of purchase of this program.

Send in your reastration card and call our sales number (1-800-443-HOLO) with your Visa or Mastercard number to place your order.

HiCard (0 memory chips) and software:	\$69.00 (reg. \$779.00)
HiCard with 256k (9 chips) and software:	\$109.00 (reg. \$759.00)
HiCard with 512k (18 chips) and software:	\$149.00 (reg. \$799.00)

Applicable sales tax will be added for Colorado residents.

*A very big **Thank** you to all of the ORBITER Alpha and Beta Testers. The long hours spent testing a program of this size are deeply appreciated and necessary to produce a "zero defect" product.*

### ORBITER RESOURCE MATERIALS

**"Space Shuttle News Reference,"** NASA, U.S. Govt. Printing Office: 1981-341-570-3256.

**The Space Shuttle Operator's Manual.** Joels and Kennedy; Ballantine Books; New York; Library of Congress Catalog Card Number: 82-90220. Available at local bookstores for \$12.95. A great book to use in conjunction with the ORBITER manual.

**The Illustrated Encyclopedia of Space Technology.**  
K. Gatland, Crown Publ. Co., Inc., New York, NY.

**"Satellites That Serve Us,"** Thomas Y. Canby, NATIONAL GEOGRAPHIC, Vol. 164, NO. 3, September 1983