

COMMODORE
AMIGA

F-15

STEALTH FIGHTER

NOT NTSC
COMPATIBLE
This product will
not function in
the USA or
Canada



MICRO PROSE
SIMULATION • SOFTWARE

The creators of GUNSHIP and F-15 STRIKE EAGLE proudly present

F-19 Stealth Fighter

The Air Force won't even talk about it. Now it's yours to fly! It's the top-secret jet that radar can't detect. F-19 STEALTH FIGHTER takes combat flying to new heights. With dazzling graphics and authentic, real-world scenarios, F-19 creates action-packed excitement that keeps you coming back for more! It's easy to learn, but satisfyingly tough to master.

More to see, do and feel than in any other flight simulator!



ACTUAL SCREEN SHOTS MAY VARY. IBM TANDY AND ATARI ST SHOWN.

Unmatched Range of Features

- Four real-world regions (Libya, Persian Gulf, North Cape and Central Europe)
- Hundreds of strategically-accurate missions
- Exclusive radar-evasive technology
- Carrier and land-based take-offs and landings
- Realistic bridges, carriers, terrain and targets
- Latest technology in electronics/weapons
- Intelligent enemy threats and weapons
- Unique threat displays and tracking systems
- Career-tracking through rank promotions and medals (including Medal of Honor)

Included for extra realism and playability:



- comprehensive, book-quality manual
- 4 detailed maps
- keyboard overlay

Revolutionary Perspectives

Watch all your dogfighting and bombing action from angles and vantage points no other flight simulator can offer.



TactiVue always keeps you *and* the enemy in sight. Dogfights and bombing runs will never be the same!



SlotVue gives you an "in-the-slot" look at your flight path without the cockpit and gauges.



TrakCam locks onto enemy targets and magnifies them for a better view of the action.

Master the stealth flying challenge!

You control pitch, roll, thrust, altitude and all the factors that increase your radar profile and give you away. If you're new to



aviation, training missions will teach you the basics first. And when you're ready for the F-19 challenge, advance to the skills of stealth flying. You'll be amazed at what you can do if nobody knows you're out there!

MICRO PROSE™
SIMULATION • SOFTWARE

© 1988 by MicroProse Software, Inc. Copyright is claimed on the text and graphics for the design of this packaging, the manual and computer software contained herein. ALL RIGHTS RESERVED.

Unit 1, Hampton Road Industrial Estate, Tetbury, Glos. GL8 8LD. Tel: 0666 504326

F19 AMIGA



5 015352 140118

F-19

STEALTH FIGHTER



F-19
Stealth Fighter
Simulation

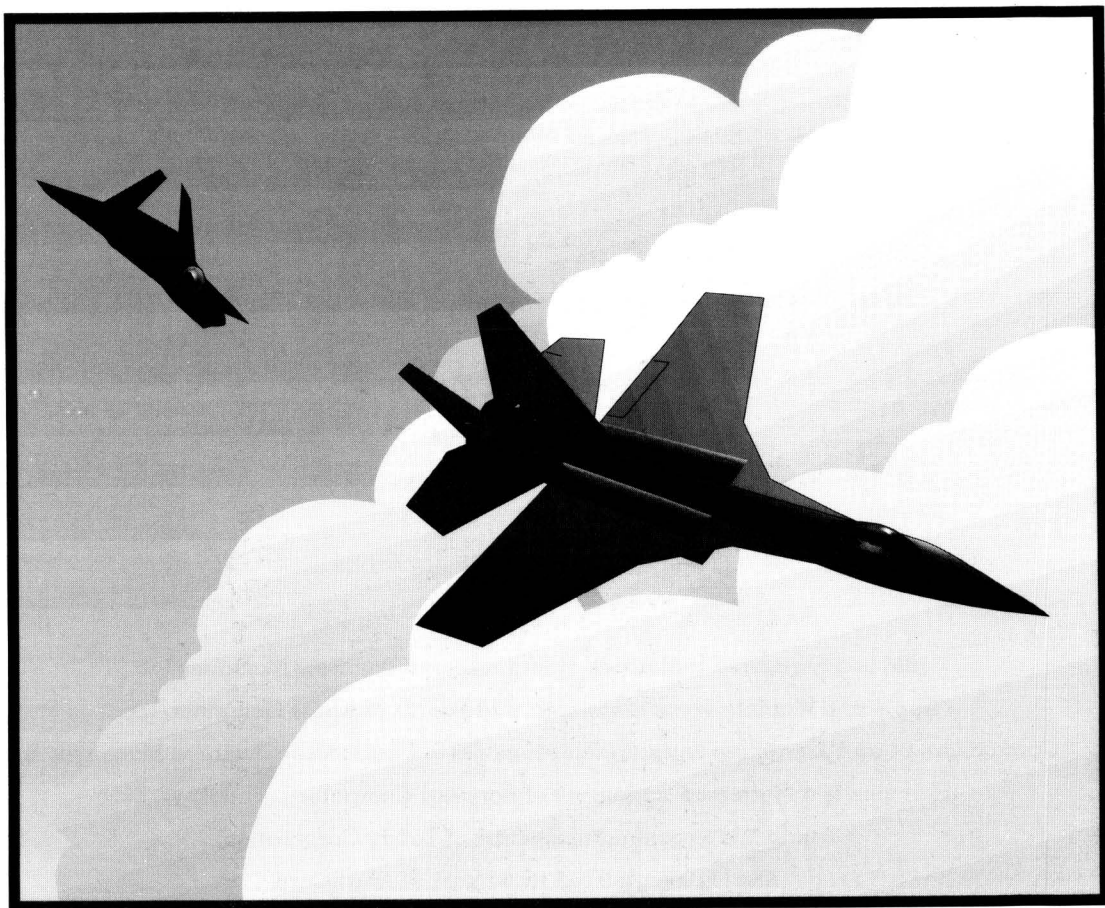

MicroProse Software, Inc.

F-19 Stealth Fighter

Computer Simulation

MicroProse Software Ltd
Unit 1, Hampton Road Industrial Estate,
Tetbury, Gloucestershire. GL8 8LD

All rights reserved.

Copyright © 1988 by MicroProse Software, Inc.

This book may not be reproduced in whole or in part, by mimeograph or any other means without permission, with the exception of quoting brief passages for the purposes of reviews.

Printing History

Printing: 9 8 7 6 5 4 3 2 1

IBM is a registered trademark of International Business Machines Inc.

Apple and Macintosh are registered trademarks of Apple Computer, Inc.

Commodore 64 and Amiga are registered trademarks of Commodore Business Machines, Inc.

Hercules is a registered trademark of Hercules Computer Technology, Inc.

Tandy is a registered trademark of Tandy Corporation.

Atari is a registered trademark of Atari Corp

F-19 Stealth Fighter Trademark, The Testors Corporation.

CONTENTS

4	The F-19 Stealth Fighter	99	4: Briefings
5	Introduction	99	Rules of Engagement
7	Quickstart	100	ONC Map Coordinates
		101	Missions
11	1: Tutorial: Training in the Simulator	101	Air-to-Air Missions
11	Your First Mission	102	Strike Missions
19	The Second Mission	106	Libya
		110	The Persian Gulf
25	2: Operating Instructions	116	The North Cape
25	Preflight Briefing	122	Central Europe
31	Simulation Controls		
31	Out of Plane Views	129	5: Equipment
33	Other Controls	129	Data Charts
34	Aircraft Controls	135	Air-to-Air Armament
34	Head-Up Display (HUD)	135	F-19 Weaponry
38	Cockpit CRTs	136	Enemy Ordnance: Cannons
39	Flight Controls	136	Enemy Ordnance: IR AAMs
43	Weaponry	138	Enemy Ordnance: Radar AAMs
45	Evasion & Defense	140	Air-to-Ground Ordnance
49	How to Fly	140	Guided Missiles
56	How to Fight	142	Laser-Guided Bombs
56	Firing Procedures	143	Retarded Bombs
61	Stealth & Defenses	145	Free-Fall Bombs
64	Postflight Debriefing	146	Other Equipment
		147	Surface-to-Air Missile Systems
69	3: Techniques & Tactics	147	Radar-Controlled SAMs
69	Aerodynamics & Flight	152	Short Range IR & Visual SAMs
74	Radar & Stealth Tactics	157	Warplanes
78	Air-to-Ground Tactics	157	Key to Aircraft Statistics
78	Ground Attack Techniques	158	American-built Aircraft
81	SAMs (Surface-to-Air Missile Systems)	164	Russian-built Aircraft
89	Air-to-Air Tactics		
89	Attack Techniques	171	Appendix
91	Air-to-Air Duels	171	Glossary
		174	Designers' Notes
		181	Credits
		185	Index

F-19 Stealth Fighter

Designer/Manufacturer: Lockheed, USA

Role: Stealth strike fighter

Crew: One

Wing Span: 31'8"

Overall Length: 59'0"

Overall Height: 13'2"

Mission Weight at Takeoff: 17 tons

Engine(s): Two General Electric F404-GE-100A
turbofans (with no afterburners) for 34,000 lbs thrust

Range: 520 miles

Ceiling: 64,000'

Maximum Speed in level flight at 0': 530 kts (Mach 0.8)

Maximum Speed in level flight at 36,000': 640 kts
(Mach 1.1)

Armament: one M61A1 6-barrel 20mm cannon, four
internal weapon bays with maximum combined
load of 6,000 lbs

Air-to-Air Radar Quality: No radar; medium range
FLIR/TV optical fire control system

Maneuverability: Fair to good

Created at the Lockheed 'Skunk Works' in Burbank, California, this novel aircraft sacrifices almost everything to a nearly invisible radar signature. The shape minimizes radar reflections. A large quantity of RAM (Radar Absorbent Material) panels, wedges and coatings are located on the ventral and dorsal surfaces, including the wings. All leading edges are cased in heat-resistant ceramics for minimum infrared signature, while engine exhausts are directed through low-signature slats.

The aircraft is designed for all-weather reconnaissance and strike missions, but can use its internal 20mm cannon, AIM-9 Sidewinder, or AIM-120 AMRAAM missiles for air-to-air interception and combat. The latest version uses a sophisticated zoom FLIR/TV/laser target tracking system that allows the pilot to see a close-up picture (either TV or thermal) of the target at all times, regardless of angle.

The aircraft is air-transportable in C-5A Galaxy transports, and can be launched and recovered from US Navy aircraft carriers.

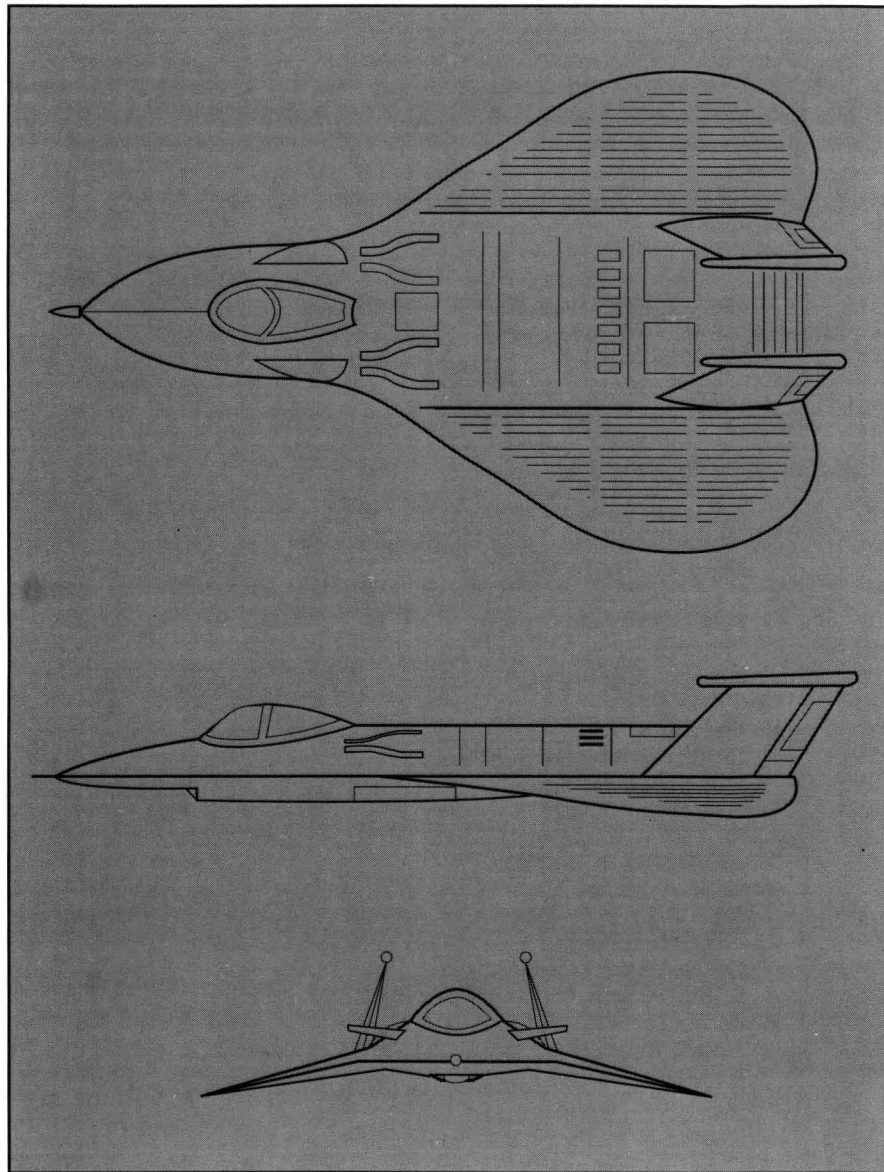

Introduction

On a moonless night a huge C-5A Galaxy transport plane touches down in Saudi Arabia and taxis to a distant hanger guarded by DIA (Defense Intelligence Agency) operatives. A large black object is rolled from the Galaxy into the hangar. Under red night-lights the hydraulic whine of unfolding wings is counterpointed by the hum of fuel tanker trucks pumping aviation gas, while sweating ground crewmen hoist bombs and missiles into weapons bays. As the Galaxy rolls away, an Air Force pilot climbs into the black plane, puts on his helmet, and begins preflight checkout. Minutes later the distinctive whine of F404 turbofans fills the hanger. A strange, rounded shape noses out of the dark hangar doorway and onto a runway. A hand pushes the throttle to full forward. With a roar the two big turbojets hurtle the craft airborne. Another Stealth Fighter mission has begun.

Tomorrow the U.S. Navy is performing retaliatory strikes against Iranian-sponsored terrorism. The Iranian planes at the Shiraz airfield must be rendered harmless tonight!

The dark waves of the Persian Gulf roll 200 feet below the wings. Off to the left are the twinkling lights of dueling Iraqi and Iranian artillery. Blue light bathes the cockpit: enemy radar is awake tonight, but the American fighter is returning a signal too weak for the enemy radar to perceive.

Two hundred miles away, 30,000 feet over the Saudi Arabian desert, an American crewman sits at one of the 22 consoles on a E-3C "Sentry" AWACS plane. The powerful AWACS radars and signals processors are monitoring the entire Persian Gulf and southern Iran areas. The crewman's fingers dance over the keyboard as he describes aircraft takeoffs, movements, and landings, as well as enemy radar and radio activity. Deep inside its massive computers, the AWACS encodes the message and transmits it in a fast, tight burst.

Dancing lights play across a HUD 200 feet above the water. As his computers decode the radio burst the lone Air Force pilot reads the incoming information. His cockpit CRTs automatically update also. He makes minute adjustments and examines his consoles once more. Yes, very good. He's timed the adjusted flight path so he'll pass behind the enemy fighter patrol, their nose radars looking away from him.

Minutes later, he accomplishes just that, then plunges into the desolate mountain valleys of southern Iran. Mountain goats and sheep scamper across the desolate highlands as a black roar passes overhead, twisting and turning to follow the valley floor.

At last he passes out of the last mountain range. Then a yellow light blinks: they got a good radar return there! Will they alert their SAMs and interceptors? It's all academic as the fighter's nose rolls downward, aiming at the military airfield on the outskirts of Shiraz.

The throttle goes to the wall and a rolling sonic boom follows behind the

dark avenger. Warnings blink as Iranian radars suddenly see an intruder directly overhead. sirens erupt, sleepy SAM crews leap to their radar consoles while fighter pilots tumble out of bed. Above, the pilot flips arming switches. Targeting symbology flashes up on his HUD while underneath bay doors whine open. A weapons pylon extends into the night sky, a stubby Maverick missile's FLIR sensor scanning until the pilot sees the distinctive heat signature of a HAWK battery controller. The missile's brain locks onto the image and its engine flares bright in the sky. Simultaneously below the battery commander launches his first HAWK surface-to-air missile at the intruder.

The HAWK's control-guidance beams cause new warnings in the cockpit, followed moments later by a strident klaxon. The missile is just seconds away. A cloud of aluminum chaff erupts behind the intruder. The HAWK attacks the cloud and explodes far behind the stealth fighter. Seconds later the slower-travelling Maverick hits the SAM controller's bunker, wrecking its radar and communications gear, disabling the entire battery.

The black fighter rolls steeply, airbrakes out. The sonic boom roars ahead of it, crashing over the airfield like the thunder of the gods. Five hundred feet above the tarmac two Durandals drop from a weapons pylon, chutes springing free at the tail of each. The bombs nose downward, floating in air over the runway. Then rocket motors explode and the bombs leap toward the ground, armored heads cutting through the thick concrete. Three feet down the warheads explode, hurling slabs of concrete in all directions.

The American pilot loops around and dives over the runway again. Two huge craters sit squarely in the middle, while nearby a number of carelessly parked jets are crumpled under pieces of concrete. A major unit of the Iranian air force is now grounded, unable to fly until lengthy repairs are made. In a single blow over forty enemy aircraft have been rendered harmless.

The black plane roars away into the mountains at 200', closing his bay and switching off jammers. To the military search radars all around, watching in helpless fury, the intruder seems to disappear. Interceptors vectoring in from other bases block the airwaves with confused chatter. The American pilot smiles and throttles back for the slow cruise home, another F-19 Stealth Fighter mission accomplished.

Quickstart

You have three options when learning to fly your F-19 Stealth Fighter.

Try & See Method: You can just dive in and try things out, referring to this manual and the Technical Insert as necessary. In this case we strongly suggest that you (a) use the keyboard overlay, and (b) glance over "Aircraft Controls" in Part II (pages 34-48) to familiarize yourself with the HUD and cockpit. As you fly, you'll find Part II in general to be an excellent reference aid. Be warned, the F-19 is a complex aircraft. Sooner or later you'll have to look at the manual.

Tutorial Method: You can use the "Quickstart" method described below for your first flight, or you can work through the more detailed tutorial on pages 11 through 23. If you like to be guided through a situation, we suggest the full tutorial. Note that the tutorial urges that you at least skim through Part II (pages 34-48)

Study Method: You can study the actual controls and operating instructions for the craft, then attempt to fly it. This is what real pilots do (or should do). In this case, read all of Part II (pages 34-48) before flying, and refer back to the section as necessary. You can use the tutorial on your first flight, or skip it, as you prefer. However, we suggest a practice mission as your first flight.

Abbreviated Tutorial

Setup & Preflight Options

1. Install the game as suggested onto floppy disks or hard disk (if you have one). See "Installation" in the Technical Supplement for details.

You can skip installation, but if you do none of your records can be saved.

2. Load the Simulation: see "Loading Instructions" in the Technical Supplement for details and specific commands.

3. Answer the Aircraft Identification Quiz: Check the back part of this manual ("Warplanes", pages 157-169) to see what aircraft is illustrated. If you give a wrong answer, you are automatically sent for training. If you give the correct answer, you are given a complete selection of all options.

4. Log onto the Pilot Roster: Following the instructions on the screen, erase one of the pilots on the roster and type your name. Enter the name by tapping the "Return" or "Enter" key.

5. Accept the Current Mission: As a new pilot, your first assignment is a standard training mission. We suggest you accept this challenge. The default options are:

- Libya region
- Conventional War situation
- Strike Training as your mission
- Green Opponents
- No Crash flight realism

6. Intelligence Briefing: Be sure to highlight and read both of the following options:

- Mission Targets
- Flight Plan

These describe your objectives, takeoff and landing points, and the Rules of Engagement (what you should and shouldn't destroy). See page 29 for a more detailed description of the Intelligence Briefing screen, its options, and information.

7. Arming Complete: Use the default armament, so select the "Arming Complete" option on this screen.

8. Begin Mission: Select this option to start your training mission.

Flying the Mission

If you selected the starting options described above, you're flying a training mission. This is just right for your first flight, since in training enemy weapons do no damage. On the first mission we recommend you concentrate mainly on flying, with a bit of simple weapons use, and ignore all those enemy planes and missiles buzzing around.

A Quick Checkout: Place and examine the keyboard overlay. This device is an invaluable aid in flying your F-19.

Find the *Pause* key command on the overlay. This command is always useful while learning.

Skim through "Aircraft Controls", pages 34-48 of this manual. They describe the cockpit and HUD (head-up display). You'll need some familiarity with these before you fly.

This first mission is exactly the mission described in the "Tutorial" (pgs 11-23). You're invited to follow the step-by-step instructions of the tutorial.

You are also invited to look at the Simulation Controls, especially the Out of Plane Views (see pgs 31-33). Experiment with these on your first few flights. You'll find the views quite interesting, and often quite useful.

1. Takeoff: Power up the engines (tap the *Max Pwr* key) and release the Brake (tap the *Brake* key) to fire the aircraft carrier catapult. Once your aircraft passes stall speed (stall speed bar drops below the center tickmark on the left-hand HUD gauge) you can pull up the nose. You must do this as you clear the carrier's deck, or else you'll fall into the sea. Tap the *Gear* key to retract your landing gear.

See "How to Fly" (page 49) for a more detailed description of takeoff procedures.

2. Fly to Your Target: Turn on the autopilot (tap the *Autopilot* key) to get on course to your target. Every time you touch the control stick, the autopilot automatically turns off. Therefore, you can experiment a bit with flight on the way to the target, then turn the autopilot on once more to get you back on course.

You'll be using your AGM-65D Maverick missiles to attack the target, so you might want to read "How to Fight", especially page 57, which describes how to operate this weapon.

Tap the *Ordnance* key to see which weapons are aboard your plane. Next find the *Select Ordnance* key and tap that, rotating through the various weapons until AGM-65D "Maverick" is highlighted. You'll notice its name also appears in the lower left corner of the HUD.

3. Attack the Target: When you get close to the Libyan coast, switch the HUD to air-ground mode (tap the *HUD Modes* key until the bottom-center label of the HUD is "AIR-GROUND") and turn on your tracking camera (tap the *Cam Ahead* key). If your primary target, the Tripoli Depot, does not appear in the lower right cockpit CRT, tap the *Select Target* key until it does.

Up on your HUD, you'll notice a box appears around an area of ground when the tracking camera finds the target. As you get closer, the box changes to a circle and the CRT screen shows the words "Missile Lock". Your Maverick missile is now locked on and ready to fire.

To fire, first open the weapons bay (tap the *Bay Doors* key), then tap the *Fire Ordnance* key to release your Maverick missile. It will find its own path to target. If you want insurance, wait a second or two, then tap the key again to fire the second missile at the same target.

4. Finishing the Mission: You can either continue the mission according to the tutorial instructions, or you can return home immediately.

To return home immediately, tap the *Select Way Pt* key to display the waypoints list on your right-side cockpit CRT. Then tap the *Next Point* key until the last of the four waypoints is highlighted. This point is your final destination, your landing strip. Now that the proper waypoint is set, you can tap the *Autopilot* key. The autopilot will turn the plane onto course for home.

As you approach the island of Sicily, switch the HUD to navigation mode (tap the *HUD Modes* key until the "NAV" label appears in its bottom center) and return to using the tracking camera (tap the *Cam Ahead* key once more). This will show the local airfield on the right-side cockpit CRT.

Landing this hot jet is tricky. However, if you follow the instructions on pages 54-55 you've got a good chance. Fortunately, the simulation is set in "No Crash" mode, so you'll survive a poor landing too. To end the mission, make sure the plane is stopped by putting the brakes on (tap the *Brakes* key) and then turn off the engines (tap the *No Pwr* key).

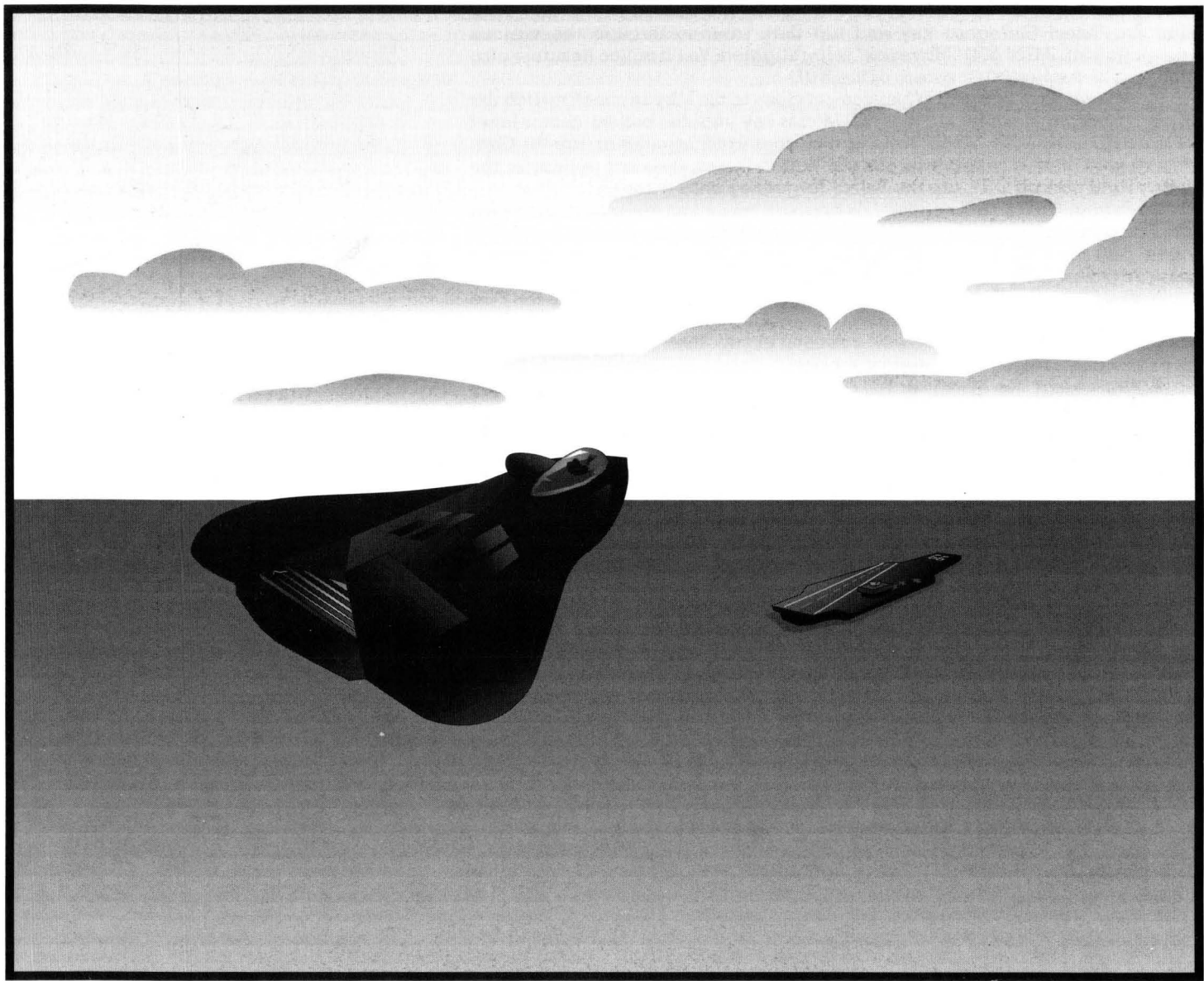

TUTORIAL

1

Your First Mission

This tutorial is designed to be your first mission. Flying this tutorial is not required. It's purely a convenience. For a faster entry into your first game, turn to "Quick Start" on page 7. If you prefer to study the aircraft before you fly it, go directly to Part II, starting on page 25.

In either case, before you start the simulation you may wish to install it on either floppy disks or a hard disk (see "Installation" in the Technical Supplement for details). You can run the simulation without installation, but no information is saved.

Now load the installed game (or the original disks, if you didn't install it) into your computer. See "Loading" in the Technical Supplement for details.

Your first mission is a practice strike against a SAM radar installation guarding the city of Tripoli, in Libya.

Keys: Each key control has a name in *italics*, which appears on the keyboard overlay. A master list appears in the Technical Supplement.

Controller refers to the pointing device used by your computer. This may be a mouse, joystick, or cursors keys, depending on your hardware.

Selector refers to the mouse button, joystick trigger, return key, or enter key, depending on your hardware setup. See the Technical Supplement for details.

During flight, the function of joystick and mouse buttons are defined in the Technical Supplement. For example, on a typical two-button joystick, the first button acts as the *Fire Cannon* key, the second as the *Fire Ordnance* key.

Answer the Aircraft Identification Quiz: Check pages 157-169 of this manual to see which aircraft is illustrated. Although a correct answer is not necessary for training missions, it's wise to acquire good habits.

Log onto the Pilot Roster: Following the instructions on the screen, use the *Controller* to select a name to erase, press the proper key to erase it, and type your name. Finish entering your name by tapping the "Return" or "Enter" key.

Terminology

Preflight Briefing Options

Accept the Current Mission: As a new pilot your first assignment is always this training mission. Use the *Controller* to highlight Accept Mission and then press the *Selector*. The tutorial training mission uses the following selections: *Libya* region, *Conventional War* situation, *Strike Training* as the mission category, *Green* opponents, and *No Crash* flight realism

Intelligence Briefing: The briefing map shows the general topography of the area, your takeoff point (T), your primary (P) and secondary (S) targets, and your landing point (L).

Be sure to highlight, select and read each of the following options:

- Mission Targets
- Flight Plan

These describe your objectives, takeoff and landing points, and the Rules of Engagement (what you should and shouldn't destroy).

A wise pilot also investigates the other options. If you wish to, see "Intelligence Briefing" on page 29 for details.

Arming Complete: You'll use the default armament, so highlight and select the *Arming Complete* option on this screen.

Begin Mission: Highlight and select the *Begin Mission* option to start your training mission.

Helpful Hints

No Danger: In practice missions, enemy weapons do no damage. You can safely ignore enemy aircraft and missiles. In addition, the "No Crash" selection means you cannot crash into the ground and will "bounce" over any hills you hit.

Furthermore, you have an automatic radar altimeter that tries to keep you above 200'. However, it only makes mild corrections, and is therefore helpless if you make truly wild maneuvers.

"Pause": To use this tutorial best, pause the simulation and read just the next few paragraphs, then "un-pause" and resume action for a short period. Whenever you're confused, just pause. Note that tapping any key (except pause) will "un-pause" and resume the action.

Resupply: In training scenarios (only) you can get an infinite supply of fuel and ammunition. Each time you tap the *Resupply* key, your fuel tank is filled to maximum and your ammunition is increased to the maximum possible level. This option is especially useful in target practice.

A Light Touch: Use a light touch on the *Control Stick*. The most common pilot error is a "ham-fist" on the stick, throwing the plane around the sky in uncontrolled abandon. Only emergencies should cause you to "peg" your stick (push it up against the stoppers, beyond which it cannot move).

Chasing the Gauges: When you roll an aircraft left or right, pitch it up or down, change the throttle, the flaps, or the brakes, it takes awhile for the plane to "settle out". Good pilots fly by making a change, then wait a couple of seconds to see the results. If you don't, you'll just "chase gauges" that are themselves still changing.

Airspeed settles out much more slowly than other settings. It takes time for your plane to build up velocity or lose momentum in level flight.

The Controls: Place the appropriate keyboard overlay on your computer keyboard. It shows all the controls for your F-19.

The HUD: The upper half of your screen represents the transparent HUD (head-up display), through which you can see the world beyond. The various symbols and numbers are described on pages 35-37.

The HUD has three operating modes: NAV for navigation, AIR-AIR for aerial combat, and AIR-GROUND for ground attacks. Tap the *HUD Modes* key to toggle through the three settings. Also note that in the AIR-AIR and AIR-GROUND modes the exact symbols depend on the current ordnance. Tap *Select Ordnance* to toggle through your weapons. If you're unsure of what weapons you have on board, tap the *Ordnance* key to see a graphic display in your cockpit.

The Cockpit: The lower half of your screen represents the cockpit of your aircraft. The various elements are described on pages 38-39. We suggest you toggle through the various CRT displays to get familiar with them.

The left-side CRT has two different map displays. Tap the *CRT Maps* key to toggle between them.

The right-side CRT either shows a camera view or a data screen, as you prefer. The data displays include:

Data key: data on target you're tracking.

Ordnance key: the weapons currently in your weapons bays.

System Damage key: which systems (if any) are damaged.

Select Way Pt key: list of the current INS waypoints, including the one you're currently being steered toward.

Change Way Pt key: list of the four INS waypoints, which you can change on the satellite/radar map (on the other CRT).

Reset Way Pt key: resets waypoints to the initial defaults.

ILS key: toggles instrument landing system graphics on and off the HUD.

Mission key: brief summary of your mission order.

The CRT camera views are a zoom TV (day) or FLIR (night) image of your target, with its name, range and bearing superimposed. The camera is limited to 80-100 km range (less at night). You have these viewing options:

Cam Ahead key: aims cameras at nearest standard target ahead.

Cam Rear key: aims cameras at nearest standard target behind.

Cam Left key: aims cameras at nearest standard target to left.

Cam Right key: aims cameras at nearest standard target to right.

Select Target key: toggles through all standard targets in current direction.

Designate New Targ key: aims forward camera at nearest target (any type) ahead. For more information on the tracking camera system, see pages 43-44.

Familiarization: the Cockpit and the HUD

Your mission starts aboard the aircraft carrier *America* sailing on a southerly course in the central Mediterranean. The preflight checklist for your F-19

Takeoff

Stealth Fighter is:

Check your INS system. Tap the *CRT Maps* key to display the satellite/radar map on your left-side cockpit CRT. Next tap the *Select Way Pt* key to display the INS waypoints on the right-side CRT. Look up on the HUD and note on the heading indicator the location of the INS Direction Indicator. You must fly in this direction to reach the first waypoint.

Check Armament: Check your ordnance (tap the *Ordnance* key) on the right-side CRT. As you use the *Select Ordnance* key to toggle through the weapons, note the active weapon in the lower left corner of the HUD.

Extend the Flaps by tapping the *Flaps* key. Note the "FLAPS" indicator in the lower right corner of the HUD. Flaps give you more lift during takeoff.

Check the Catapult System: When launching from an aircraft carrier, as you are now, the brakes must be set. This represents attaching the aircraft to the deck's steam catapult. If the HUD does not show "BRAKE" in the lower right corner, tap the *Brake* key to set the brakes and engage the catapult.

Start the Engines: Turn on your engines by tapping the *Max Pwr* key. Notice the throttle power indicator rising on the far left side of the cockpit.

Activate Catapult: When the throttle indicator shows maximum power, tap the *Brake* key. This releases the brakes and catapult, hurtling you off the deck.

Accelerate Past Stall Speed: As you zoom down the deck, watch the speed scale (left side of the HUD) very carefully. A colored bar on that scale will gradually drop down. This is the stall speed indicator. When the stall speed bar drops below the center tick on the scale your plane is past stall speed. You are travelling fast enough to get into the air.

Climb: Once you're more than 10 kts faster than the stall speed, pull back on the stick a bit to point your nose upward. Be firm, but don't pull all the way. Once the nose is skyward, release the stick. Watch the altitude scale on the right side of the HUD: you'll start climbing. Don't climb so steeply you lose sight of the horizon. That can cause a stall.

You must start climbing by the time you reach the end of the carrier deck. Otherwise you'll plunge into the sea.

Retract Landing Gear: Once you're airborne, immediately tap the *Gear* key to retract your landing gear. Don't leave the gear down — high speeds can rip off your landing gear.

Retract Flaps: Tap the *Flaps* key to retract your flaps. You no longer need the extra lift. Again, high speeds can rip off the flaps, causing serious damage to your wings.

Flying to the Target

Level Flight: Once airborne your first step is to achieve level flight. Push the control stick forward or back until the horizon is level across the middle of the HUD. Then make fine adjustments until the round flight path indicator (on the HUD) cuts through the middle of the horizon and you're neither gaining nor losing altitude.

Don't confuse the nose indicator with the flight path indicator (see illustration on page 34). Always use the flight path to aim your plane (even though the indicator bounces around some). Do not use the nose indicator, since a plane's nose and its flight path rarely point in exactly the same direction!

Since this is a stealth mission, you want level flight at 500' to 1,000'. Look at the altimeter (strip gauge on the right side of the HUD). If you're above the 1k mark (1,000') you're too high. Push the nose down into a gentle dive until you reach the desired altitude. Then level out and again place the flight path indicator on the horizon.

Flying on Course: Now it's time to get onto the right course. Look at the heading indicator across the top of your HUD, and the INS Direction Indicator (the small, bright triangle somewhere on the top of the scale). Turn toward the indicator. As you turn the triangle moves toward the center; when the triangle is in the center of the scale you're "on course" to the first waypoint.

To turn, gently pull the stick left or right. The plane will bank. Release (center) the stick when the bank angle is about 45°. To increase the rate of turn you can pull back on the stick somewhat. As you do this, watch your speed (on the left of the HUD) and altitude (on the right). A turn with backpressure can slow your plane and rob you of lift, causing altitude loss.

Minimum safe speed varies with the current situation of your aircraft. A "stall indicator" bar will rise from the bottom of the speed scale when you travel too slowly. If this bar reaches the tick-mark in the center of the scale, your plane is stalling. In a stall the plane is no longer airworthy, and begins to fall out of control. Therefore, do not stall the plane.

If you do stall the plane, lower your nose to regain airspeed, then pull out into level flight.

Minimum safe altitude is about 200'. However, in this training mission stay at 500' above the ground.

Autopilot: If you're hopelessly confused about which direction to fly, and how to do it, just tap the *Autopilot* key. It will take over immediately, turning you onto the correct course. If you're below 500' the autopilot will climb to that altitude. If you touch the control stick the autopilot automatically turns off.

Enjoying the Flight: Once on course, enjoy yourself by trying out all the nifty viewpoints available. You can return to the cockpit at any time: just tap the *Cockpit* key.

You can see out the front, rear and sides of the cockpit canopy using the *View Ahead*, *View Rear*, *View Left* and *View Right* keys. These keys assume you are looking past the cockpit area. They give a nearly unobstructed view of the outside landscape. In mountain valleys and over urban areas the scene can be quite thrilling.

You can also step "outside" your aircraft and watch it using the *Chase Plane*, *Slot View*, and *Side View* keys. Bank the plane left and right to observe the difference between the chase plane (where you appear to be in a plane following in the "footsteps" of the F-19) and the slot (where you remain behind

the F-19 and always remain level). Although the chase plane is more visually exciting, the slot view is handy when learning aerobatics.

The *Tacti View*, *Invr's Tacti* and *Missile Views* are used in combat situations. See pages 31-33 for more detailed description of these options.

Passing the First Waypoint: When you reach the first waypoint you'll see a message in your HUD. Your INS system immediately switches to the next waypoint, which is your primary target. If it isn't (because you've accidentally changed the waypoints) just tap *Reset Way Pt*. This resets the waypoints to the starting default, with waypoint #2 at your primary target and waypoint #3 at the secondary target.

Extra Fuel: You'll notice that one of the four items in your weapons bay is an extra fuel tank. This is because the mission from the CV *America*, to Tripoli, and then to Sigonella in Sicily, is a very long trip.

To see your fuel status, tap the *Select Way Pt* key. The bar gauge across the bottom shows the fuel on hand. The dark area at the right end of the bar is fuel consumed already. The four bands in the middle represent the amount of fuel needed to reach each of the four waypoints. Fuel calculation is based on your current altitude and speed. The final band to the left represents the amount of spare (reserve) fuel available.

Your jet engines cannot draw fuel directly from the extra tank. They can only draw fuel from the regular, main tanks. Therefore, to use the extra fuel you must pump it from the extra tank into the main tank.

To accomplish this task, first tap the *Select Ordnance* key until the extra fuel is the current weapon. You can tell this by the text in the lower left corner of the HUD. You can also change the right-side CRT to display the weapons and highlight the current one by tapping the *Ordnance* key.

Now that fuel is selected, tap the *Fire Ordnance* key to "fire" the fuel from the spare into the main tank. If you tap the *Select Way Pt* key once more, you'll see the fuel status has changed.

Accelerated Time: If you find the journey somewhat dull, you can speed the passing of time by tapping the *Accel Time* key. This doubles the rate at which time passes. To return to normal time, simply tap the *Norm Time* key. Combat activity or landing automatically returns you to normal time.

Attacking the Target

Once you are well past the first waypoint and the coast of Libya is on the horizon, it's time to start thinking about the target.

Check the Tactical Situation: Switch your left-side cockpit CRT to the gridded tactical map (tap the *CRT Maps* key). Your target is a radar station, so look for a radar symbol on this map.

Acquire the Target: Switch your HUD to AIR-GROUND mode (tap the *HUD Modes* key until it comes up), then tap the *Cam Ahead* key. If your target doesn't appear in the right-side CRT, tap the *Select Target* key until it does. If you cycle through every targets and still don't see the primary, you're either too far away to see it or you're somehow flying in the wrong direction.

Select your Weapon: Tap the *Select Ordnance* key until the weapon in the lower left corner of the HUD reads "2 AGM-65D" and/or "2 Maverick".

Wait for Range, Altitude and Missile Lock: You'll notice that a box appears in the HUD. This is the "target box"; the target seen on the zoom TV CRT is in the middle of this box.

When you get within launch range for a missile this box changes to an oval shape. In addition, "Missile Lock" flashes on the right-side CRT.

The oval shape means your missile can hit if you attack at maximum speed. If you wait longer, eventually the oval changes color. This means the missile can hit regardless of your speed. Of course, if you fire the missile at an inappropriate target, it might hit but not cause damage — the ability of weapons to destroy targets is summarized on page 131.

It's important that you not launch a weapon too low. You may be caught in your own bomb blast, or a missile may hit the ground before its motor can power it up and away. A simple rule to get you started is that missiles and retarded bombs require at least 500' altitude, free-fall and laser bombs 3,000'.

Launch: When you have "Missile Lock", open the weapons bay (tap the *Bay Doors* key), then launch the missile by tapping the *Fire Ordnance* Key. After launching, turn away slightly, since flying through an exploding target could damage your aircraft.

Shortly thereafter the missile should hit the target. A successful hit causes a fire and sends a cloud of smoke up into the sky.

The Secondary Target: You can now fly to the secondary target and attack it as well, using the same procedure. Or, if you wish, you can call it quits and immediately start for home.

Setting the INS to the Landing Point: Tap the *Reset Way Pt* key and then the *Select Way Pt* key. The reset way point insures that the default waypoints are now loaded in your INS (inertial navigation system).

Now examine the list of waypoints on the right-side cockpit CRT. There are four waypoints listed. If the bottom (fourth) point is not highlighted, tap the *Next Point* key until it is highlighted. This switches the INS and waypoints system to that point. The last point on the default list is always your return base.

Flying Home: You can either use the autopilot or manually fly the plane home. As before, guide yourself using the heading scale (horizontal scale at the top of the HUD). When the INS Direction Indicator triangle is lined up on the center of this scale, you're on course toward your home base.

If you look at the map, you'll notice there's a small island (Malta) just south of Sicily. You should steer just east (to the right) of Malta. As you near Malta, change your HUD to NAV mode (tap the *HUD Modes* key), then tap the *Cam Ahead* key. If the Sigonella airbase comes up on the right-side CRT, fine, this is your destination! However, it's likely that Halfar airfield on Malta will appear instead (since it's closer). Therefore, tap *Select Target* until Sigonella appears.

The Satellite/Radar map on the left side CRT may help you see this better. Tap the *CRT Maps* key if the tactical display (the gridded map) is still on the left-

The Return Trip

side CRT. You can enlarge and reduce either map by tapping the *Zoom* and *UnZoom* keys.

Landing at Sigonella Airbase

About 50 km from Sigonella start lining up your approach for landing.

Level Flight: First achieve level flight at 500' to 1,000' altitude.

ILS: Next, turn on the ILS (instrument landing system) by tapping the ILS key. A horizontal and vertical bar appear on your HUD. These ILS symbols represent your position in relationship to the "glide slope". The glide slope is an invisible "beam" that angles out and up from the end of the runway. First you'll line up beneath this glide slope, and then follow it into the airbase, eventually intercepting the descending slope line and following it down to the end of the airstrip. For more information on ILS systems, see "Using the ILS" on page 42 and especially pages 52-53.

Line Up Your Approach: If the vertical bar is left or right of you HUD nose indicator, turn about 90° in that direction and fly until the bar start moving toward the center. Then turn toward Sigonella. You want to get back onto a course of 000° just as the bar centers on the HUD. However, don't worry if the bar is a little off center. As long as Sigonella is dead ahead the vertical bar will gradually creep toward the center. However, if the bar is moving away from the center, it's a sign you're travelling away from the glide slope — in that case turn the other way to correct the problem.

Reduce Speed: Now cut your throttle back to about 50% power (tap the *Decr* key a few times). Your speed will gradually decrease. To maintain level flight you'll have to pitch up your nose a bit (watch the altimeter on the right side of the HUD).

Extend Flaps: When your speed reaches about 300 kts, tap the *Flaps* key. This extends the flaps (notice that "FLAPS" appears on the HUD). This slows you further and gives you more lift. You'll have to readjust the nose a little to maintain level flight.

Lower Gear & Reduce Speed Again: Tap the *Gear* key to lower your landing gear. You can visually check that the gear is down by tapping the *Side View* key. Return to the cockpit view by tapping the *Cockpit* key. You can also check this by the color of the "GEAR" light on the left side of the cockpit (see the Technical Supplement for the color key).

Now cut the throttle back to about 40% power. As your speed gradually decreases you'll have to raise the nose to maintain level flight. By this time you should be close to the glide slope, and travelling about 200 to 250 kts with your speed still decreasing.

If you're moving too fast, tap the *Brakes* key (to open your air brakes), then a few seconds later tap it again to close the airbrakes. Do not leave the airbrake open, it may cause you to stall and crash later.

Intercept the Glide Slope: As you get near the airfield, the horizontal ILS bar begins to move downward on the HUD. When the bar approaches the HUD nose indicator center (the middle of the HUD), pitch your nose down a little.

Your objective is to go into a gradual descent that keeps the bar centered in the middle of your HUD (crossing the center of the HUD nose indicator). To avoid gaining speed in the descent, reduce your power (*Decr* key) a tap or two.

As the airstrip comes up, first check your speed. You should be travelling 150-200 kts, or decreasing from 250 kts toward 200 kts.

If your speed is above 250 kts, you're coming in too "hot" (too fast). Go to maximum throttle (tap *Max Pwr*), retract your landing gear and flaps, and try again: fly to Malta, turn around there, and start over.

If your speed is too slow, look at the stall bar (the colored bar rising from the bottom of the airspeed gauge). If the stall bar is close to the middle of the scale, you're getting into trouble. Tap the *Incr* power key once or twice.

Touch Down: If your speed is correct (150-200 kts), start watching the altimeter. It should be at 300' to 100' and decreasing. Make small adjustments with the control stick to keep the descent rate steadily, but not too fast. The runway is at 0' altitude. When you hear the squeal of your wheels on the pavement, tap the *Brakes* key instantly, then shut off the engines by tapping the *No Pwr* key. You've just made a safe landing.

On your second practice mission it's time to learn about enemy radars, aircraft and missiles. Select exactly the same options as the first mission — you'll fly the same strike against a Tripoli radar station, but now you must worry about the enemy too.

Mission Planning: Before takeoff, check out the intelligence briefing in more detail. Highlight the *Radar Sites* option and select it. An overlay of concentric circles appears on the map. Each solid circle is a doppler radar, each dotted circle a pulse radar. Moving the *Controller* left and right cycles through each radar station, giving you additional data.

This screen helps you plan a route to Tripoli and back. Remember, the waypoints in your airplane are the default route shown on the map. You may wish to fly a different route, to evade enemy detection as much as possible.

Basically, you avoid detection by doppler radars if you arc around them, keeping a constant range to the radar. You avoid detection by pulse radars if you fly directly toward or away from them. For more information about this see "Radar & Stealth, Stealth Tactics" starting on page 76.

When you're done, you should have a mental "map" in your head of where enemy radars are, how you'll fly through them to avoid detection, and what weapons you'll use where to achieve your objectives.

Adjusting Waypoints: After you select *Begin Mission*, but before you take off, you may wish to adjust the waypoints to fit your new mission plan. The first waypoint, by default, is half way between your takeoff point and the primary target. Most pilots adjust this point.

To make adjustments, first tap the *CRT Modes* key until the colored satellite map appears on the left-side cockpit CRT. Then tap the *Change Way Pt* key to

The Second Mission

display the waypoints list on the right-side CRT (and, incidentally, the waypoints course plan on the left-side CRT). Use the *Adjust Waypoints* keys to move the waypoint around the map. Notice that the course lines automatically “snap” to the new waypoint as you move it. If you don’t like your adjustments, just tap *Reset Way Pt*. This resets all the waypoints to the initial default.

Default waypoint settings always are:

Waypoint #1: halfway between takeoff point and primary objective.

Waypoint #2: the primary objective.

Waypoint #3: the secondary objective.

Waypoint #4: the landing point.

Flying to the Target: After take off, as you fly to the target, watch the radar patterns on the satellite/radar map (on the left-side CRT).

Enemy radar signals are displayed graphically. Dotted arcs are pulse radars, solid arcs are doppler radars. Ground search radars are entire 360° circles, while ground fire-control tracking radars are short arcs. Aircraft radars, search or fire-control, are short arcs (except for AWACS aircraft that have an entire 360° circle).

Missiles and aircraft also appear on this map as color-coded dots. See the Technical Supplement for details.

You’ll notice that enemy aircraft with their forward-facing radars may complicate your original plan for penetrating enemy air defenses. You’ll have to sneak behind or underneath the enemy.

Flying Stealthy: Now that you understand the situation, it’s time to watch the EMV (electro-magnetic visibility) scale.

The “visibility” of your plane to enemy radar appears as a bar rising from the bottom of this gauge. Your visibility increases as you climb to higher altitudes, increase speed, open bay doors, lower gear, or use jammers.

The bars coming down from the top of the scale are incoming enemy radar signals. Ground-based radars appear on the left, aircraft radars on the right. The bar color represents whether the radar sees you or not (see the Technical Supplement for a color key). Bar colors match the radar arc colors that appear on the Satellite/Radar map (on the left-side CRT).

You want to fly low (about 200') to keep your EMV small. You want to fly toward or away from pulse radars (especially the strongest!), and fly at a constant distance (arcing around) doppler radars. This keeps the enemy signal weak (i.e., reduces the size of their “bars” coming down the gauge).

Warnings

Eventually, though, you may make a mistake, or a previously silent enemy radar may suddenly turn on. Even if enemy radars don’t see you, a successful attack always alerts them.

Search Warning: Enemy search radar detects your plane when the enemy radar strength bar overlaps your EMV bar.

Search detection means that enemy fighters are vectored toward your location, and that any surface-to-air missile (SAM) batteries in the area start

tracking you as a target.

Tracking Warning: Long-range and medium-range SAMs must track a target with radar before firing. Tracking radar appears as a short, narrow arc on the Satellite/Radar map.

When the enemy tracks you, the "TRAK" warning is lighted in the cockpit.

Some short range enemy missiles do not use a radar tracking system. Therefore, "TRAK" is not a foolproof warning of impending attack.

Missile Warning Lights: If a radar-homing missile is launched toward you, the "R" missile warning light flashes in the cockpit. If an IR (infrared) homing missile is launched toward you, the "I" missile warning light flashes.

The appropriate light continues to flash as long as the missile is homing on your plane. If jammers or some other device confuse the missile, the light goes off. If the missile later finds you again and starts homing once more, the light begins flashing again.

If two or more missiles of the same type are homing on you, that light continues to flash as long as any missile is homing.

Missile warning lights are very important, since they're the only way to tell what kind of missile is attacking. The type of attacking missile (radar or infrared) determines what sort of defenses you should use.

Missile Proximity Klaxon: When a missile approaches within a few seconds flight time of your plane, the proximity klaxon goes off. This very loud signal means you must do something, immediately, or you'll be hit. Typically you'll drop a chaff or flare cartridge, depending on the type of threat (chaff for radar missiles, flares for IR missiles). However, you can also attempt some last-second maneuvering.

When the TRAK or missile warning lights go off, it's time to warm up your missile defenses, since an attack is incoming.

Understand the Attack: The first step is to check out the attack. Switch the left-side cockpit CRT to the tactical display (tap the *CRT Maps* key). Use the *Zoom* and *UnZoom* keys until the you find a useful scale. Missiles are small color-coded lines (see the Technical Supplement for a color key).

Disappearing: If you're attacked by radar-guided missiles (either the "TRAK" light is on, or the "R" missile warning is lighted), you can evade the attack by reducing your EMV or lowering the enemy radar's effectiveness (or both). If the enemy radar loses sight of you, the missile loses guidance and flies on blindly.

Decoys: Your F-19 carries only three decoys. To launch a decoy, tap the Decoy key. The "DCY" light in the cockpit turns on, and remains lighted while the decoy is running.

Each decoy is a computer-controlled "imitation" of your aircraft that is easier for the enemy to detect and lock onto. Enemy missiles, aircraft and radars will follow the decoy, thinking it's you. Meanwhile you can pour on the speed and escape. Eventually the enemy will discover the ploy and start

Missile Defenses

looking for you again. The amount of time varies with the skill of the enemy. The "DCY" light in the cockpit remains lighted while the decoy is functional.

Jammers: Use the ECM jammer against radar-guided missiles (missiles that light the "R" warning). Tap the *ECM* key to toggle the ECM jammer on and off.

Use the IR jammer against IR guided missiles (those which light the "I" warning). Tap the *IR Jammer* key to toggle the IR jammer on and off.

After you turn on the jammer, change to a different course and get away from the missile. If you don't, when you turn off the jammer (or when an advanced missile gets close enough to "burn through" your jammer), the missile starts homing on you again! Advanced missiles that "burn through" jamming include semi-active radar missiles, command guidance radar missiles, and second generation IR missiles.

Don't leave your jammers running. The ECM jammer increases your EMV, while the IR jammer reduces your speed. In addition, the IR jammer can overheat, causing it to automatically shut down until it cools off.

Chaff and Flares: A chaff or flare cartridge decoys a missile for two or more seconds. During that time the missile flies toward the chaff (if a radar homing missile) or the flare (if an IR homing missile).

Fire a chaff cartridge (tap the *Chaff* key) when a radar-guided missile sets off your missile warning klaxon and "R" warning light.

Fire a flare cartridge (tap the *Flare* key) when an infrared or visually guided missile sets causes off your missile warning klaxon and "I" warning light.

Maneuvering: Missiles only have a 45° forward "view". If you're outside of this arc, the missile cannot track you. Therefore, if you "blind" the missile with a decoy, jammer, chaff, or flare, then fly outside its arc, the missile may lose you and fly away. Some missiles, unfortunately, can circle around for another pass.

Missiles also have very wide turning circles. You can "turn inside" a missile, causing it zoom past you. See "Outmaneuvering a Missile" on pages 87-88 for more details.

Advanced Combat: Weapons & Techniques

You'll want to try various weapons against land and air targets on this mission.

To learn the more about weapons, read the "Weaponry" section on pages 43-45. Then turn to "How to Fight" on pages 56-63 for more details and specific instructions. Additional background and sophisticated tactics are explained in "Air-to-Ground Tactics" (pgs 78-88) and "Air-to-Air Tactics" (pgs 89-97).

The Data Charts, on pages 129-134, provide a useful summary of various weapons, including which is most effective against which type of target.



Airman's Medal

This medal is commonly awarded for heroism that involves the voluntary risk of life under conditions other than those of conflict with an opposing armed force.



Distinguished Flying Cross

This medal is awarded for heroism or extraordinary achievement while participating in aerial flight, including valorous performance in combat.

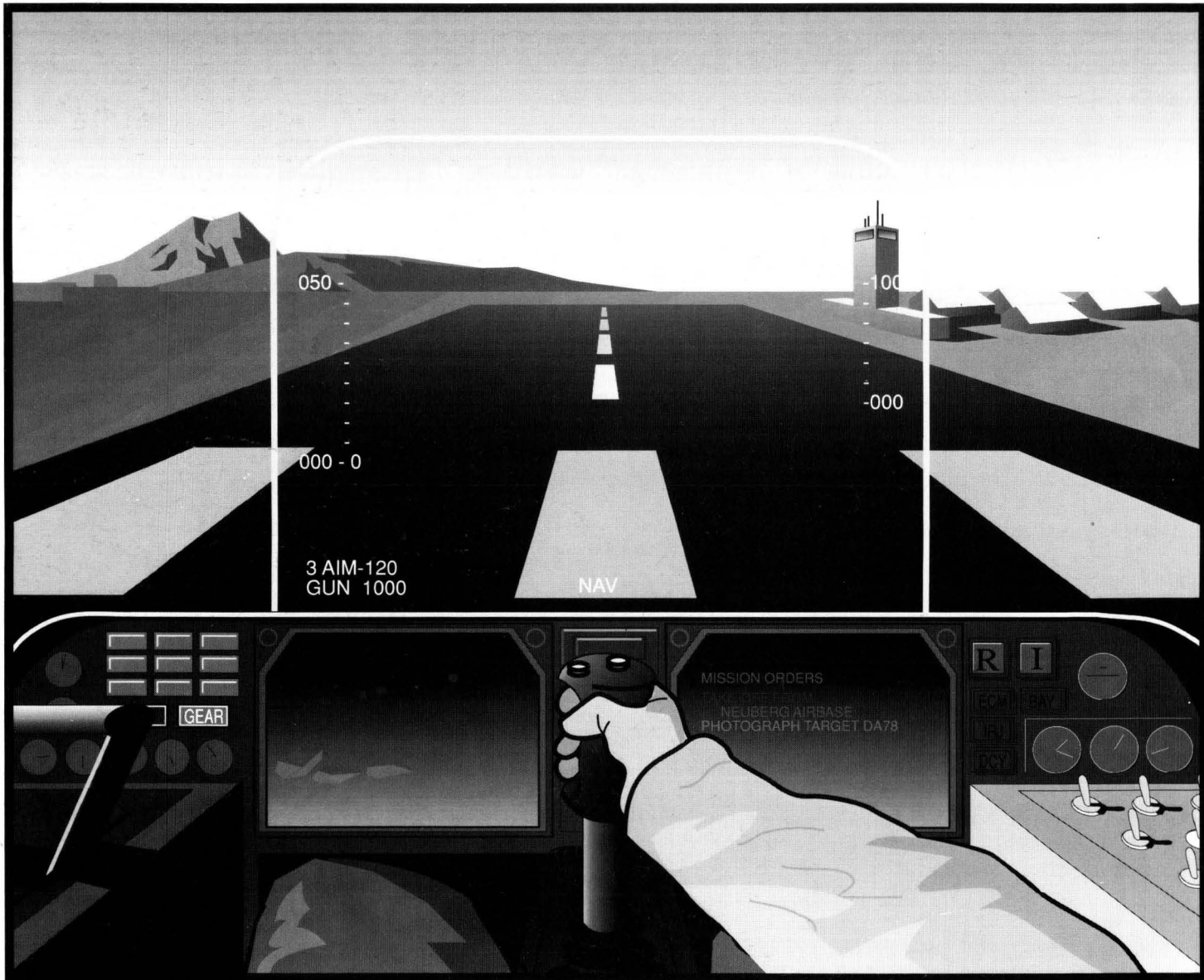

OPERATING INSTRUCTIONS

2

F-19 Stealth Fighter has many options. To make a choice, move the *Controller* up and down to highlight the option, then press the *Selector*. See the Technical Supplement for the location of the *Controller* and the *Selection* on your computer.

You may be asked questions about your equipment. See the Technical Supplement for details, including advantageous trade-offs.

To choose your own mission assignment, you must correctly identify an aircraft. Flip to the back of this manual (see "Warplanes", pages 00-00) and find the drawing which matches the screen illustration. Observe carefully the shape of the wings, fuselage, nose and cockpit for accurate identification. Then select the correct name.

If your identification is wrong, you are automatically assigned to training.

If the identification is correct, you have your choice of assignments.

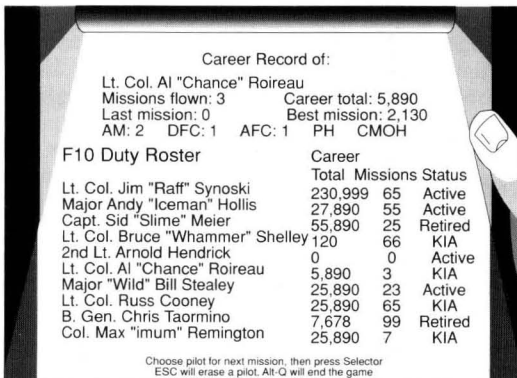

Career Record of:

Lt. Col. Al "Chance" Roireau
Missions flown: 3 Career total: 5,890
Last mission: 0 Best mission: 2,130
AM: 2 DFC: 1 AFC: 1 PH CMOH

F10 Duty Roster

	Career	Total Missions	Status
Lt. Col. Jim "Raff" Synoski	230,999	65	Active
Major Andy "Iceman" Hollis	27,890	55	Active
Capt. Sid "Slime" Meier	55,890	25	Retired
Lt. Col. Bruce "Whammer" Shelley	120	66	KIA
2nd Lt. Arnold Hendrick	0	0	Active
Lt. Col. Al "Chance" Roireau	5,890	3	KIA
Major "Wild" Bill Stealey	25,890	23	Active
Lt. Col. Russ Cooney	25,890	65	KIA
B. Gen. Chris Taormino	7,678	99	Retired
Col. Max "Imum" Remington	25,890	7	KIA

Choose pilot for next mission, then press Selector
ESC will erase a pilot. Alt-Q will end the game

Preflight Briefing

Hardware Options

Aircraft Identification

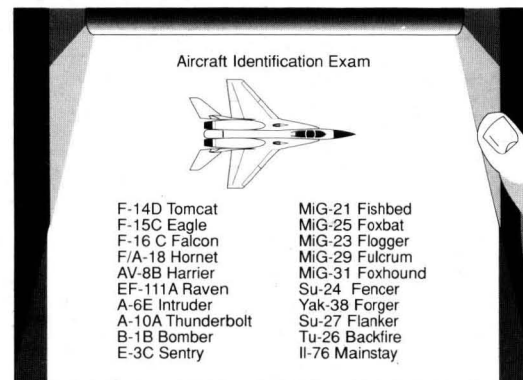

On the "Duty Roster" you can start a new career or continue an existing one. Instructions appear on the screen. Note that if you erase a pilot's name here, the results are permanent.

You cannot save pilot records unless you follow the installation instructions. See the Technical Supplement. Here you see your current

Duty Roster

Mission Assignment

mission assignment. You can either accept these, or request a change. If you accept the assignment you go directly to the intelligence briefing for the current mission.

If you request a change, you'll see a variety of options, starting with which region of the world you prefer. Requests for a changed assignment are *not* held against you (scoring and promotion are not affected).

Region of the World



Here you select one of four regions for your new assignment.

Libya is a moderately challenging client state of the Soviet Union. In the recent past the Libyan government has been one of the main supporters of international terrorism, and on the receiving end of American air and naval air attacks.

Training missions in Libya are fixed. Strike training is always a mission from the USS *America* to Tripoli; Air-Air training is always an interception of fighters patrolling over Benghazi.

Persian Gulf: This region is a slightly more complex and challenging situation. Iran is a radical, revolutionary state involved in a long war with Iraq, as well as numerous shooting incidents with the US Navy.

North Cape & Central Europe: These regions are the most challenging. Here the full strength and power of the Soviet Union and the Warsaw Pact are opposed by numerically inferior but qualitatively superior NATO forces (including your F-19). Should superpower skirmishing or a full-blown World War III occur, victory and defeat would hinge on events in these two regions.

Level of Conflict

The level of conflict in the region has a dramatic effect on how you must fly your missions. Each type of conflict has its own challenges. No choice is easier than another. In general, the hotter the war situation, the more violent and frenetic the situation, while cold war demands careful planning and good judgement — different skills, but no less important ones!

Cold War means clandestine missions. Flying without being detected is paramount. If you are detected, you must destroy the plane or radar which saw you. However, the more you use weapons, especially against any other targets, the greater the scandal, and the less successful your mission. In fact, many missions in the cold war involve photo reconnaissance, flying secret materials in or out, or surgically "removing" a single, specific target.

In the Cold War stealthy flying is crucial. Fortunately, enemy radars and SAMs aren't expecting trouble. They often confirm a contact many times before attacking.

Limited War missions are also clandestine. It is still important to fly without being seen, but since warfare is ongoing, military targets are fair game now. However, be careful to avoid hitting civilians. Attack and strike missions are common, but so are photo reconnaissance and clandestine spy missions. In limited war enemy radar operators expect some trouble. Their reactions are slightly faster.

Conventional War is all-out conflict. Inflicting the maximum destruction upon the enemy is the main objective here. Avoiding detection has no political importance, but is useful if you want to survive the mission! Any target in enemy territory is fair game, military or civilian. However, enemy air defense operators rarely confirm their targets — in wartime everybody shoots first and asks questions afterward!

You may select from two types of “real” missions and two types of “training” missions. Training missions represent flying a flight simulator instead of flying a real aircraft.

Air-to-Air Missions have an enemy aircraft as your primary objective. If you’re a hotshot with AAMs (air-to-air missiles) and dogfighting, this is your cup of tea. However, the secondary objective is often a ground target.

Strike Missions have a ground target as the primary objective, and usually as your secondary objective too.

Training Missions generate normal air-to-air or strike missions, as appropriate, with three exceptions:

(1) *No Damage*: You cannot be hurt by enemy fire. Hits inflict no damage on your aircraft.

(2) *No Score*: You are not scored for the mission. You receive no rating points, no decorations, no promotions. After all, the mission wasn’t real! On the other hand, a poor showing doesn’t bring down your average (as it might after a real mission).

(3) *Libya*: If you selected Libya, your specific mission orders are always fixed. Strike missions are always against a ground target in Tripoli, Air-to-Air missions are always against fighters over Benghazi. If you’re just learning to fly and fight the F-19, this feature allows you to try the same mission over and over, until you understand fully what’s happening.

The quality of your opponents controls the difficulty of the simulation. The better your opponents, the more difficult your job, but the greater your rewards. Your score is significantly affected by this option.

Selecting regular or green opponents reduces your score, making promotions slower and putting the highest medals out of your reach. Selecting elite opponents increases your score, speeding up promotions and making medals easier.

Green Opponents: Here the enemy has older aircraft and SAMs. His radar sets are poorly maintained and frequently out of order. Radar operators only understand the rudiments, and therefore are very bad at understanding the sometimes strange signals given off by your plane (allowing you to fly closer to them without being spotted). Enemy pilots have virtually no skill in aerobatics and dogfighting (just flying the plane is a big challenge for them).

Regular Opponents: Here the enemy has aircraft and SAMs appropriate to the region: older equipment for third world and client states, more modern equipment when you face a superpower directly. Radar operators are trained

Type of Mission

Opponent Quality

and drilled, but lack combat experience. Enemy pilots have practiced mock dogfights and aerobatics, but lack the quick perception and aggressive maneuvering of a combat veteran.

Veteran Opponents: Here the enemy has aircraft and SAMs appropriate to the region, like regulars, but tend to use only the better equipment in combat (veterans realize the futility of using obsolescent weapons against a first class enemy like you!). Radar operators are experienced, with a good sense of judgement that makes your job harder. Enemy pilots are skilled dogfighters, often with a few kills to their credit. Expect fast, aggressive moves from them.

Elite Opponents: Here you face the enemy's best. Elite troops always get the best available equipment. Radar operators know their equipment inside out, and can interpret your faint, confusing returns only too well. Enemy pilots are often aces who know every trick in the book, and aren't above inventing new tricks where they can. Dogfighting against these guys is the ultimate challenge.

Flight Performance

No Crashes: This is the ideal choice when learning to fly. Your F-19 literally cannot crash. In a crash situation it just rights itself and keeps on going. If you hit a mountain side you're bounced upwards and keep on going. When landing you can hit the ground as hard as you like and still survive. Unless you're landing (i.e., with landing gear down), an automatic barometric altimeter keeps your plane above 200', simplifying low-level flying.

However, enemy weapons are not affected by this choice. If your plane is shot out of the sky by guns or missiles, it will crash and kill you (unless you successfully eject first).

Your score is significantly reduced if you select this option, making promotions and medals hard to get.

Easy Landings: This is the preferred choice of casual, weekend flyers. Safe landing parameters are relaxed considerably, which makes one of the toughest jobs (landing a really hot jet) much easier. To avoid a crash you must touch down on a runway, aircraft carrier, or prepared landing strip. Hitting the ground or water anywhere else destroys the plane. As in "No Crashes", an automatic barometric altimeter keeps your plane above 200' unless you're landing (i.e., with landing gear down).

Exact landing parameters are shown on the screen. You may wish to copy these down for future reference.

Your score is only slightly reduced if you select this option. Promotions are not materially affected, and you can qualify for all but the highest medals.

Realistic Landings: This is the real experience, in full. You must be skilled and "in practice" to be consistently successful with realistic landings. Coming down too fast (either vertically or horizontally) can mean instant death.

Exact landing parameters are shown on the screen. You may wish to copy these down for future reference

Your score is full value if you select this option. If all other selections are of similar difficulty, you gain higher rank and medals quickly.

On this screen move the *Controller* up and down to highlight one of the options below. Then press the *Selector* to toggle that option's data on and off the map. When an option's data is visible, moving the *Controller* left or right cycles through specific data on each item.

This screen, with its great variety of information, is the perfect place to plan your mission. You may wish to take notes about especially dangerous enemies, or the route you have in mind.

Your takeoff point (T), primary target (P), secondary target (S), and landing point (L) are always visible on the briefing map, as reference points.

Mission Targets: This presents a detailed description of your operational orders, with specific information about the primary and secondary objectives. You should also look at your flight plan (below) for additional information.

Radar Sites: The *Selector* toggles radar sites on and off the map. You can use the *Controller* to cycle through data on each site in turn.

Missile Ranges: The *Selector* toggles missile sites on and off the map. You can use the *Controller* to cycle through data on each site in turn.

Air Bases: The *Selector* toggles airbase sites on and off the map. You can use the *Controller* to cycle through data on each site in turn.

Flight Plan: This presents a detailed description of your takeoff and landing sites, estimated fuel required, and your ROE (Rules of Engagement).

Special Events: This shows any special enemy activity. Areas marked as especially active are likely to have lots of small shoulder-launched SAMs, and therefore be quite dangerous.

Exit Briefing Room: This ends the intelligence briefing. You can return later if you desire.

Here you can select whatever weaponry and equipment you desire for each of your four weapons bays.

To select a weapon, use the *Controller* to move the highlight among the weapons, then use the *Selector* to choose the highlighted weapon. Then you must use the *Controller* once more to move the highlight among the bays (to select which bay will carry the weapon) and press the *Selector* a second time to put the weapon in that bay (removing the weapon originally present).

Note that your estimated fuel required, and current fuel carried, appear along the bottom of the aircraft diagram. Make sure you have enough fuel to complete the mission!

Default Armaments: The initial weapons loaded in Bays #1 and #2 represent your crew chief's choice of ordnance for your mission. The weapon in Bay #1 (the upper left graphic) is for the primary target, the weapon in Bay #2 (the upper right graphic) is for the secondary target. Extra fuel in bays #3 or #4 represents the crew chief's guess that you'll need it, given the distance involved.

Intelligence Briefing

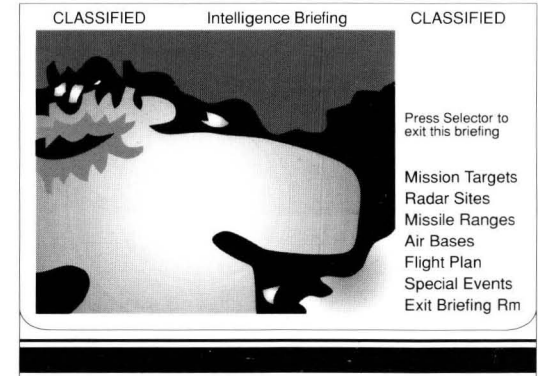

Arming

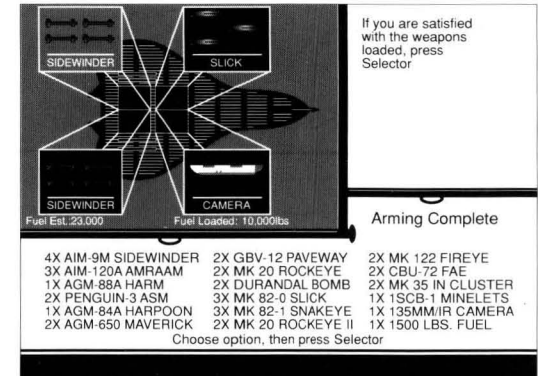

Choosing Armaments: See the "Data Charts" on pages 129-134, for details about each weapon. The "Weapon Effectiveness against Common Targets" chart, page 131, rates all weapons against all common targets. It's wise to carry at least one "A" or "B" rated weapon for the primary and secondary objectives.

Final Choices

Your final option before leaving the preflight briefing area has the following four choices:

Select New Mission: You can refuse the current mission and ask for a new one. There is no penalty involved in this, but it's considered a cowardly and unpatriotic act that earns the disdain of real fighter pilots everywhere.

Intelligence Briefing: This returns you to the intelligence briefing screen, where you can further examine the current situation and orders.

Arm Your Plane: This returns you to the arming options, where you can reconfigure your aircraft as you prefer.

Begin Mission: When you select this option, you're ready to fly. In seconds you'll be in the cockpit, ready to take off.



Simulation Controls

As an aid to learning flight maneuvers, a variety of out-of-plane viewpoints are available. In all these views you are outside of your aircraft, looking at it and/or the enemy. Many different perspectives are available.

Press the *Cockpit* key to return to the normal in-the-cockpit viewpoint.

Press the *Slot View* key for this view. It is named after the famous “in the slot” position used by aerial acrobatic teams.

Here you are positioned directly behind the F-19. Unlike the chase plane, the viewpoint remains level with the ground, so you can clearly see the degree of pitch and roll in the F-19 itself.

The *Zoom* and *UnZoom* keys function in this view, moving your viewpoint closer to (*Zoom*) or farther from (*UnZoom*) the F-19.

This view is an excellent one for learning the most efficient and effective flight maneuvers.

Press the *Chase Plane* key for this view.

Here you are positioned in a “chase aircraft” that follows a short distance behind the F-19. As the F-19 accelerates, it will tend to “run away” from the chase plane, while when the F-19 slows down it tends to “fall back” toward the chase plane.

Although this view is very dramatic, its use as a teaching and learning aid is limited.

Press the *Side View* key for this view.

Here you are positioned to the right side of the F-19. The *Zoom* and *UnZoom* keys function in this view, moving your viewpoint closer to (*Zoom*) or farther from (*UnZoom*) the F-19.

This view can provide a useful reference point. It’s also an excellent way to check the state of your landing gear. Missile launches are most dramatic when seen from this viewpoint.

Press the *Tacti View* key for this view.

Here you are positioned right behind the F-19, looking past it at whatever target is being tracked on the plane’s HUD. This view automatically rotates and pans to keep both the F19 and its target in view.

The *Zoom* and *UnZoom* keys function in this view, moving your viewpoint closer to (*Zoom*) or farther from (*UnZoom*) the F-19.

This view is invaluable when dogfighting. It helps you outmaneuver and

Out-of-Plane Views

Return to the Cockpit

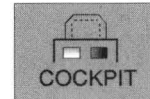

Slot View

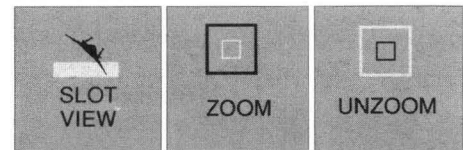

Chase Plane View



Side View

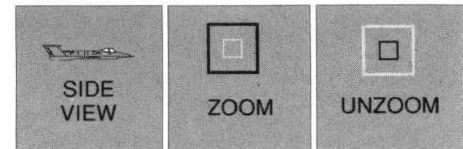

Tactical View

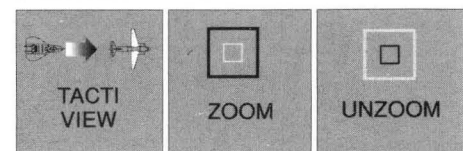

line up on an opponent (although it's wise to return to the cockpit before shooting, to avoid wasting ammo). The view is also useful if you want to return for a second or third attack run on a ground target.

Inverse Tactical View

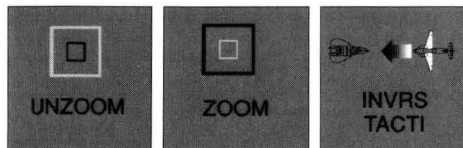

Press the *Invrs Tacti* key for this view.

Here you are positioned right behind the F-19's *target*, looking past it at the F-19 itself. The target may be another plane, or a ground target — whatever your tracking camera is following (see pages 43-44). In either case, you see the target in the foreground, and the F-19 far away. In fact, often your F-19 is nothing but a dot in the sky. This view automatically rotates and pans to keep both the target and the F-19 in view.

The *Zoom* and *UnZoom* keys function in this view, moving your viewpoint closer to (*Zoom*) or farther from (*UnZoom*) the F-19's target.

Experienced pilots find this a very dramatic view when making attack runs on ground targets. It's a great showoff view, swinging to follow your plane as you fly overhead.

Missile View

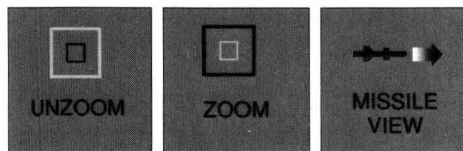

Press the *Missile View* key for this view.

Here you are positioned directly behind the F-19's active weapon. If ordnance is in flight, you are positioned behind the weapon launched most recently. If no ordnance is in flight, you are positioned behind the plane, and will follow the first item launched.

The *Zoom* and *UnZoom* keys function in this view, moving your viewpoint closer to (*Zoom*) or farther from (*UnZoom*) the missile.

This view is very entertaining, as it lets you follow the weapon directly to the target. If you're having trouble understanding why your weapons miss, switching to this view after launch can be extremely educational.

Standard & Wide-Angle

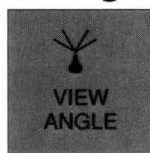

The *View Angle* key toggles between a 60° standard viewing arc and a 120° wide-angle viewing arc. This inclusion/exclusion of peripheral vision applies to all the views above.

The Movie Director

An experienced pilot, flying in training mode, can use these views to good effect. By switching between the cockpit and various views, you can illustrate what's happening and impress casual bystanders.

For example, you can use the *Chase Plane* view to watch your plane launching from the carrier and turning onto course (use the autopilot after launch to simplify this). Then switch to *Slot View* and show off loops, rolls, split-S turns and Immelmans (see pgs 94-95 for details on these maneuvers). Find an enemy aircraft and use the *Tacti View* to show your plane maneuvering against his. Then switch to *Invrs Tacti* to watch his responses. Before launching a missile go to the *Side View*, to watch the weapon dropping away. Then jump to the *Missile View* to follow it into the target. The possibilities are as endless as your imagination.

Other Controls

The *Pause* key immediately and instantly freezes the simulation. To resume action, press any key. Some computers have a special "pause" or "hold" key. Depending on the internal design of your machine, this key may also work.

Pause

The *Accel Time* key doubles the rate at which time passes. "ACCEL" appears on the HUD. Accelerated time is useful when flying long distances without encountering any significant threats or opposition.

Accelerated Time

The *NormTime* key returns the simulation to its normal time rate, regardless of what the accelerated rate was. You should return to normal time before combat: it's very hard to control and fight your craft in accelerated time.

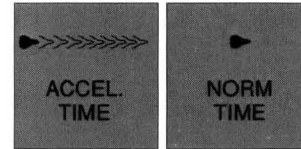

In combat and landing situations you're automatically returned to normal time. Accelerate time automatically stops if either (a) you're detected by enemy radar, (b) open the weapons bay, or (c) lower the landing gear.

The *Detail Adjust* key allows you to change the amount and depth of ground detail visible through the cockpit. See the Technical Supplement for details. In general, the slower your computer, the lower the level of detail you should use.

Detail Adjust

The *Volume Adjust* key allows you to change the type and variety of sounds used in the simulation. See the technical supplement for details. When you press the key, the new sound setting appears briefly on the HUD.

Volume Adjust

The *Resupply* key is available *only* in training missions. Pressing this key fills the plane's fuel tanks and gives it extra weapons. Resupply is designed for sight-seeing and target practice. Needless to say, those who prefer realism in simulations (including in training) should never touch this option.

Resupply

The "*Boss*" *Hide Game* key immediately pauses the simulation and clears the screen, effectively concealing what software is really running on the computer. To resume, you must press the "*Boss*" *Hide Game* key again.

"Boss" Hide Game

This key is not only useful at the office, but also to forestall irate parents, children, spouses, and relatives who complain time you spend at the computer!

There is no "save" key in *F-19 Stealth Fighter*. Instead the simulation automatically saves your record as a pilot whenever you leave the pilot roster during the preflight briefing.

Save

This "automatic save" feature requires you to be using a copy of the program (a copy on either a floppy or hard disk), rather than the original MicroProse disk from the box. If you are using the original disk, you cannot save data, although you can otherwise run the simulation normally.

The *Quit* key immediately ends the simulation. It does not save any information to disk, so any accomplishments since the last time you saw the pilot roster will be lost.

Quit

Aircraft Controls

Terminology

Keys: Each control has a name in *italics*, which is used on the keyboard overlay. A master list of all names and keys also appears in the Technical Supplement (in case your overlay is damaged or lost).

Controller refers to the pointing device used by your computer. This may be a mouse, joystick, or cursor keys, depending on your hardware. See the Technical Supplement for details.

Selector refers to the mouse button, joystick trigger, return key, or enter key, depending on your hardware setup.

During flight, the function of joystick and mouse buttons are defined in the Technical Supplement. For example, on a typical two-button joystick, the first button acts as the *Fire Cannon* key, the second as the *Fire Ordnance* key.

Head-Up Display (HUD)

The HUD is designed to provide you, the pilot, with all the crucial flying and weapon information in a graphic format. HUD data is projected onto a wide-angle clear pane in the front of the cockpit. You look "through" the HUD display to the situation outside. As a result, valuable information is right in front of your eyes, where it is most useful.

See the Technical Supplement for a detailed depiction of the HUD and cockpit display.

HUD Modes

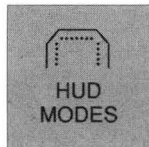

The HUD display has three modes: NAV, AIR-AIR, and AIR-GROUND. You switch between modes using the *HUD Modes* key.

The current HUD mode appears on the bottom center of the HUD display.

The NAV mode is designed for flying and navigation between airbases. In this mode your tracking system is restricted to friendly and neutral airbases and aircraft carriers.

The AIR-GROUND mode is designed for attacking ground targets. Your tracking system is restricted to these targets. Although your tracking system contains only a limited subset of the possible targets, you can temporarily add more using the *Designate New Targ* key.

The AIR-AIR mode is designed for attacking aircraft. Your tracking system is restricted to these targets only.

Some HUD information is universal across all modes. Other information is specific, available in just one of the modes.

Universal HUD Information

Airspeed appears on the left-side vertical scale, in knots. Beside the tick-mark showing your current speed is a digital readout of your speed.

Stall Speed Indicator: At times a colored bar rises from the bottom of the scale. This bar represents your stall speed. If the bar rises above the center tick-mark on the scale, your plane has stalled. A stalled plane falls out of control for a period of time before the automated recovery system takes over. A stall at low altitude is often fatal.

Altitude appears on the right-side scrolling vertical scale, in feet above average ground level. At 1,000' and higher the scale changes to thousands ("2K" means 2,000' altitude, "13K" means 13,000' altitude, etc.). A digital readout of your current altitude appears next to the scale's tick-mark.

VVI Indicator:

At times a colored bar extends upward or downward from the center tick-mark on the altitude

scale. This is the VVI (Vertical Velocity Indicator).

If the VVI bar extends downward, your plane is losing altitude. Each tick-mark represents 100 feet per minute. Therefore, the larger the bar, the faster you're going down.

If the VVI bar extends upward, your plane is gaining altitude. Each tick-mark represents 100'/min. Therefore, the longer the bar, the faster you're going up.

Landing Speed Indicator: This colored arrow appears only when your landing gear is down. It indicates the safe maximum VVI for landing. If the VVI bar is below this mark, attempting to land risks a crash.

Heading: The horizontal scale across the top is your heading in degrees. North is 000°, East is 090°, South is 180°, and West is 270°.

INS (Waypoint) Direction Indicator: The colored diamond marker on the top of the scale shows the heading you should fly to reach the currently selected INS "waypoint". To get "on course", turn until the diamond marker is above the middle tick-mark on the scale.

Nose Indicator: This cross-hairs symbol is fixed in the middle of the HUD, and represents the direction your nose currently points.

Flight Path Indicator: This indicator shows the direction you are flying (which can be different from the nose indicator!). It is available only in the NAV and AIR-GROUND mode. In AIR-AIR mode it is replaced by the gunsight.

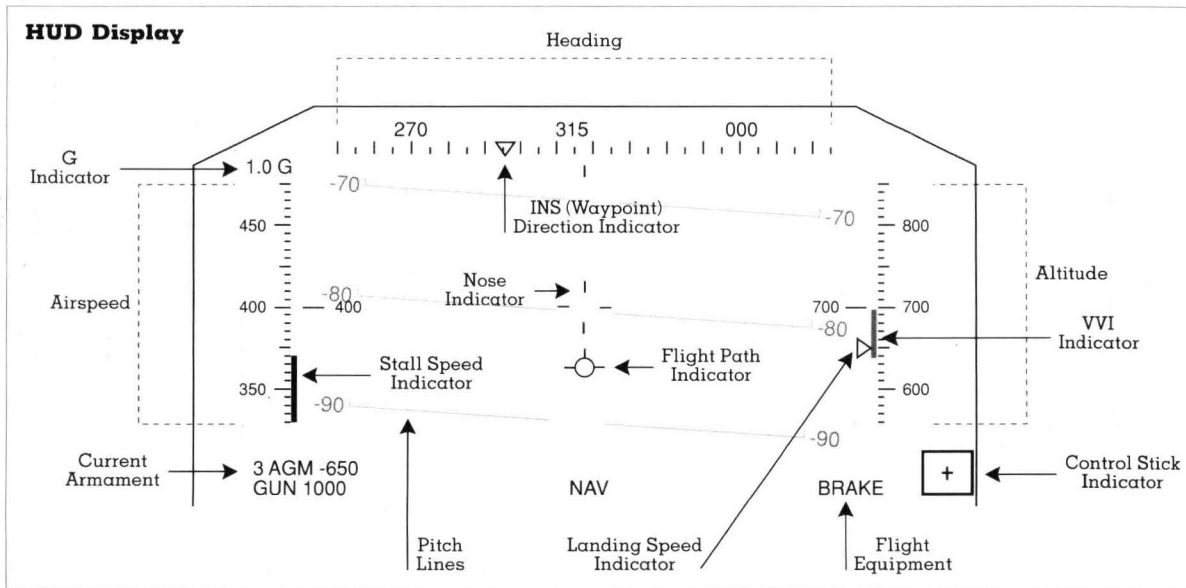

The plane is geometrically level when the nose indicator and flight path indicator overlap. However, this is rare in an aircraft. Furthermore, *level flight* (where you are neither climbing or diving) often requires the nose to be pitched slightly above the flight path, to achieve a useful *angle of attack*. See *Aerodynamics and Flying Techniques*, page 70, for more information.

G-Indicator: This readout in the upper left corner of the HUD indicates the current G-forces on your plane's airframe. In general, the plane can withstand more G stress than the pilot, whose limits are between -3 G and +9 G, depending on training and experience.

Pitch Lines are superimposed on the HUD if your nose is pitched so far up or down that the horizon is invisible. Each major line represents 10° of pitch up or down. If your aircraft is geometrically level, pitch is 0°. If your aircraft is climbing straight up or diving straight down, the pitch is 90°.

Roll is indicated by the relationship of the horizon or pitch line to the cockpit and nose indicator. If the horizon or a pitch line is perfectly horizontal, your craft is level. If the line angles to the left or right, you craft is rolled to the right or left.

Current Armament: In the lower left the HUD indicates what weapon is currently selected, and the number currently available, such as 3 Sidewinder AIM-9M missiles, or 2 Slick Mk 82-0 bombs, etc.

Below this line is the word "Gun" followed by the number of rounds currently available. This refers to your 20mm cannon and its remaining ammunition. A jam or loss of the gun, should it occur, is noted here also.

Flight Equipment Indicators: If special flight equipment is functioning, a note appears on the lower right of the HUD. "FLAPS" appears when the flaps are extended. "BRAKE" appears when the airbrake is extended or wheel-brake is on.

Control Stick Box: If you aren't using a physical joystick, the control stick locator box appears in the lower right corner of the HUD, to help you see the current stick position.

Radio Messages: Coded burst transmissions arrive by radio periodically. These are decoded by your onboard computers and displayed as text across the top of the HUD, just underneath the heading scale.

Tracking Box: Tap the *Cam Ahead* key to activate (or reset) the F-19's computerized optical tracker. A small box appears around the nearest standard target ahead, to help you locate it. The HUD mode determines whether ground or air targets are tracked. The *Cam Rear*, *Cam Left* and *Cam Right* keys set the optical tracker in that direction instead (see below). Once the tracker is locked onto a target, it follows that target, even if it moves from one quadrant to another. Of course, the box is only visible on the HUD when the target is directly in front of you.

Air-Air Mode Indicators

Tap the *HUD Modes* key to change your HUD into air-air mode.

Gunsight: In this mode the gunsight circle replaces the flight path indica-

tor. The gunsight shows where your shells would be landing if you'd fired two seconds ago (the time it takes them to travel the 6 kilometer maximum range). If you're tracking a target that's closer than 6 km, it shows where the shells would land if you'd fired the proper time in the past for them to travel that range. See "How to Fight, the 20mm Cannon" (page 57) for details on using the gunsight.

Missile Targeting Envelope: This is a large but faint circle fixed on the HUD. It represents the area of the sky where an air-to-air missile can be aimed and "locked on" to a target.

Tracking Box & Oval: Any of the four *Cam* keys activates the tracking camera system in that direction. A small box appears around the target, to help you locate it. On most systems the tracking box is color-coordinated with the current armament (as shown on the HUD, see above). The box color indicates whether the current weapon is effective against that target. See the Technical Supplement for details on colors.

When using missiles or other self-guided weapons, the box turns oval when the target is within firing range and the missile is "locked on". This is a maximum range shot that assumes the target is stationary and your plane is moving at maximum speed (over 500 kts). When the oval changes color the shot is now a "sure thing", with nearly no chance of missing.

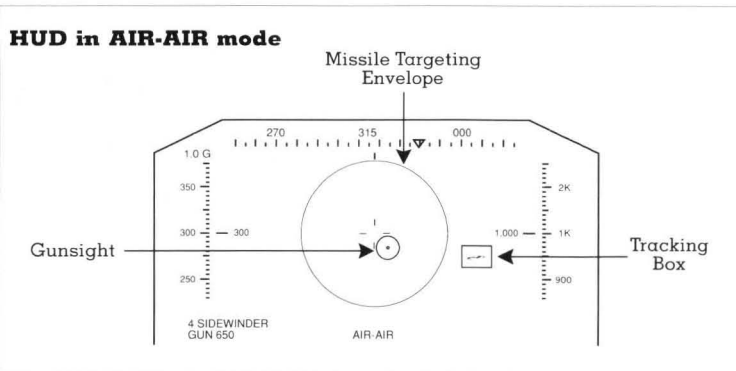

Tap the *HUD Modes* key to change your HUD into air-ground mode.

Tracking Box & Oval: Any of the four *Cam* keys activates the tracking camera system in that direction. A small box appears around the target, to help you locate it. On most systems the tracking box is color-coordinated with the current armament (as shown on the HUD, see above). The box color indicates whether the current weapon is effective against that target. See the Technical Supplement for details on colors.

When using missiles or other self-guided weapons, the box turns oval when the target is within firing range and the missile is "locked on". The oval changes color when accuracy has reached its maximum.

Bombsights: When free-fall and/or retarded bombs are the current armament, a special set of bombsight aids appears on the HUD. Note that the fall-line and bullseye only appear for free-fall bombs.

Bombing Flightpath Guide: This indicates the "path in the sky" you should fly for a perfect bombing run. Keeping your flight path indicator centered within this symbol means you're "on course".

Bombsight Ranging Bar: This indicates the distance before

Air-Ground Mode Indicators

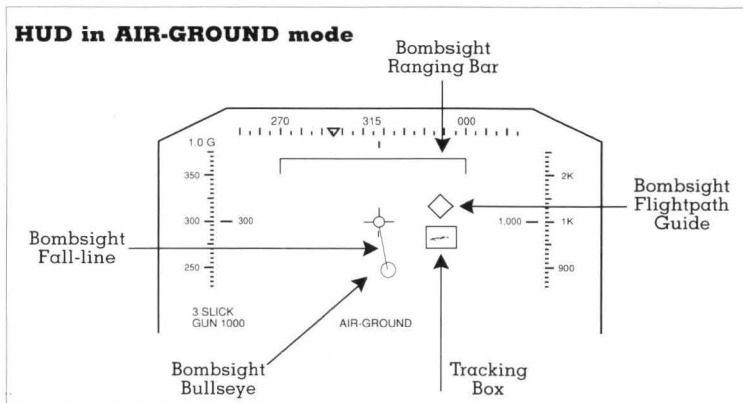

proper bomb release. As you get closer to the drop point, the bar compresses. When it becomes a single vertical line (or dot) it's time to drop the bomb.

Bombsight Fall-line: This appears only if free-fall bombs are the current armament. A line extends from your flight path toward the ground. At the end of this line is a circle. Your bomb will land in the middle of this circle.

Bombsight Bullseye: This is a circle at the end of the fall-line. The center of the circle indicates the predicted strike-point of the bomb.

Killing Yourself: If your current course, speed and altitude will take you within a bomb blast, the HUD bombsight symbology flashes. You can still drop a bomb in this situation, but you should take appropriate action to escape the resulting blast.

Camera Lens Sight: If your current armament is the 135mm/IR camera, the camera lens sight appears on the HUD. This is a small "+" symbol in the lower center. It represents the direction your camera lens aims.

Cockpit CRTs

Maps (Left-Side) CRT

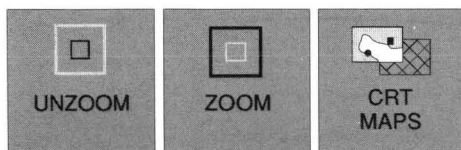

This CRT appears on the left side of the cockpit. It displays two different types of maps. Tap the *CRT Maps* key to toggle between the two types.

Either map can be expanded or contracted to show more area or more detail, using the *Zoom* and *UnZoom* keys.

The Satellite/Radar Map portrays the geographical features of the region, and is oriented so North is always toward the top of the CRT.

Enemy radar signals are displayed graphically on this map. Dotted arcs are pulse radars, solid line arcs are doppler radars. Ground search radars are entire 360° circles, while ground fire-control tracking radars are short arcs. Aircraft radars, search or fire-control, are short arcs except for AEW&C aircraft (the Il-76 "Mainstay" or E-3C "Sentry"), which have an entire 360° circle.

Missiles and aircraft also appear on this map as color-coded dots. See the Technical Supplement for details. If a dot is your primary target, it flashes and glows.

The Tactical Display portrays the local tactical situation. It is oriented so the top of the face corresponds to your flight path. Thus the map rotates as you turn.

The map graphically depicts aircraft (color-coded for altitude), missiles, ground radar sources, airfields, and incidental ground targets. A 16km square grid is superimposed for range referencing. See the Technical Supplement for details on the color coding of this map.

Warning: The airbase symbols on this map are icons only. They may not be correctly aligned. Do not use this map for landings!

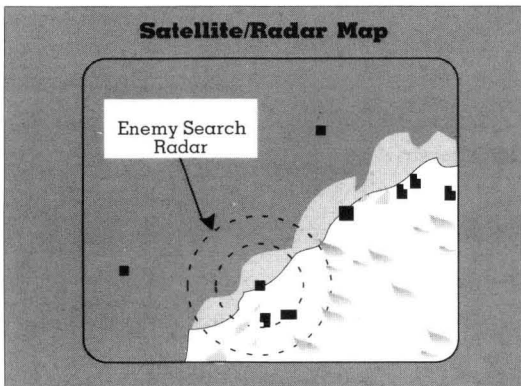

Camera/Data (Right-Side) CRT

This CRT appears on the right side of the cockpit. It has many different functions. Tap the appropriate key to activate the desired function:

Cam Ahead: This aims the tracking camera ahead and locks it on the nearest standard target. A zoom TV view of the target appears on the CRT with

range and direction information.

Cam Rear: This aims the tracking camera to the rear, locking it onto the nearest standard target, and showing the zoom TV picture on the CRT.

Cam Left: This aims the tracking camera to the left, locking it onto the nearest standard target, and showing the zoom TV picture on the CRT.

Cam Right: This aims the tracking camera to the right, locking it onto the nearest standard target, and showing the zoom TV picture on the CRT.

Data: Displays data on the target currently targeted by the tracking camera.

Ordnance: Displays the ordnance currently on board your F-19.

Damage: Displays which systems (if any) are damaged on your F-19.

Waypoints: Displays waypoint data for each of the four INS waypoints, and displays predicted fuel consumption (given current flight performance).

Way Reset: Resets the INS (inertial navigation system) waypoints to the initial (default) values. Waypoint #2 always becomes the primary target, waypoint #3 always becomes the secondary target.

ILS: Toggles the Instrument Landing System (ILS) on and off. When turned on, it projects ILS symbology on the HUD and locks the tracking camera to an airbase.

Mission: Displays a summary of your mission orders.

Camera/Data (Right-Side) CRT

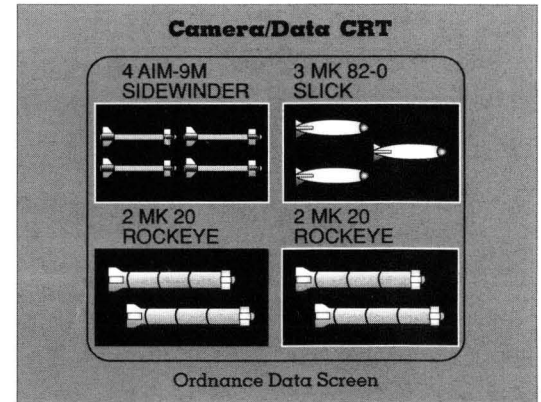

Flight Controls

Control Stick

The F-19 has a standard aircraft control stick. Pushing the stick forward pitches the plane down, pulling it back pitches the plane up. Pushing the stick left rolls the plane to the left, while pushing it right rolls the plane to the right.

Note that the more you push the stick, the more the aircraft pitches or rolls in that direction. When you release the stick (i.e., center it) the aircraft remains pitched or rolled in that attitude. You must move the stick in the opposite direction to level your plane.

The control stick may be represented by a physical joystick, numeric/cursor keypad, or some other device. See your Technical Supplement for details. If you are not using a "real" joystick, a control stick locator box appears in the lower right corner of the HUD. This shows you the current position of your stick.

The throttle controls the power output of your engines. Maximum throttle ("full military power") gives you maximum speed and performance, but also uses up fuel faster and increases your EMV (electro-magnetic visibility).

Throttle Handle & Indicator: The twin handle device on the far left of the cockpit represents the throttle control. The closer the handles are to the main cockpit panel, the greater your engine power. On the base of the handles is a bar-like scale that shows the amount of thrust being generated.

Throttle Controls: The *Max Pwr* key immediately opens the throttle, giving you maximum thrust.

Throttle

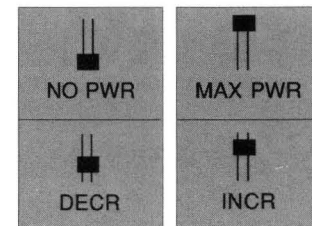

The *No Pwr* key immediately closes the throttle, shutting down the engines.
The *Increase* key opens the throttle a small amount.
The *Decrease* key closes the throttle a small amount.

Autopilot

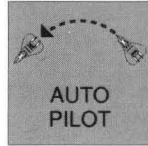

The *Autopilot* key toggles the automatic pilot on and off. The autopilot, when active, flies you toward the next INS waypoint. If you're below 500' altitude, the autopilot climbs to that altitude. When the autopilot is on, the cockpit "AUTO" light is on.

If you touch the control stick in any way, the autopilot automatically turns off. In other words, it works like the "cruise control" of a modern American automobile.

Warning: The autopilot does not avoid hills and mountains!

Brake

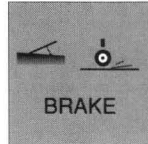

If your aircraft is airborne, the *Brake* key toggles the airbrake retracted (in) and extended (out). When the brake is extended the aircraft slows down because the airbrake causes extra drag.

If the aircraft is on the ground, the *Brake* key toggles the landing gear brakes on and off.

In either case, if the brakes are on, the word "BRAKE" appears in the lower right corner of your HUD.

Flaps

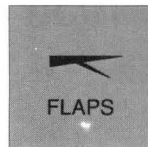

The *Flaps* key toggles the wing flaps between extended (out) and retracted (in). When the flaps are extended (out) the aircraft slows down, gains lift, and stall speed is reduced.

If the flaps are extended, the word "FLAPS" appears in the lower right corner of your HUD.

Do not have your flaps extended above 300 kts speed. Higher speeds can rip off the flaps, causing serious damage to your wings.

Landing Gear



The *Gear* key toggles your landing gear up and down. The "GEAR" light in the cockpit indicates the landing gear position (see the Technical Supplement for colors).

If the "GEAR" light flashes, it means the gear is down at too high a speed — you should either slow down or raise the landing gear. Not only does extended landing gear slow you down, but high speeds can rip it off entirely, causing serious damage.

Viewing Controls

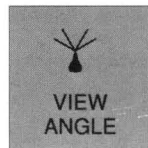
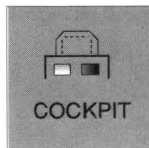

Cockpit: Tap the *Cockpit* key for the standard pilot view, looking out of your cockpit through the HUD.

View Angle: The *View Angle* key toggles between a standard viewing arc (about 60°) and a wide-angle viewing arc (about 120°). The wide angle arc is an excellent way to spot and track objects, especially in a fast-moving dogfight.

The current viewing angle (standard or wide) applies to all other views, and can be changed from any view.

View Forward: Tap the *View Ahead* key to turn off the HUD and look up

over the cockpit control panel. This view gives you maximum visibility forward, unobstructed with the cockpit or HUD.

View Rear: Tap the *View Rear* key to look out the back of your aircraft.

View Left: Tap the *View Left* key to look out the left side of your aircraft.

View Right: Tap the *View Right* key to look out the right side of your aircraft.

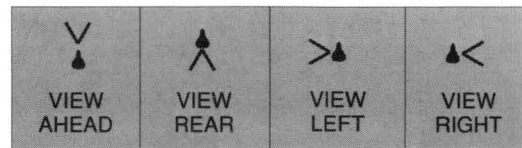

Concept: The INS (inertial navigation system) has up to four programmable "waypoints". You use these to map out a route to your target(s) and back again. The default waypoint setup puts the first point halfway between your starting base and the primary target. The second is the primary target; the third is the secondary target; and that last is your landing point.

Waypoints Display: The *Select Way Pt* and *Change Way Pt* keys display the INS waypoints list on the right-side CRT and your projected flight path from waypoint to waypoint on the satellite/radar map of the left-side CRT.

The waypoints list includes the current time at top, the flight time to each waypoint, and across the bottom a fuel gauge. The fuel gauge is a bar-graph of predicted fuel consumption, given your current speed and altitude. The far right side of the bar shows the amount of empty space in the tank, the far left side shows your reserves, while the center parts show the amount of fuel needed to reach each waypoint. The gauge is color-coded, see the Technical Supplement for details.

Selecting Waypoints: The INS waypoints list on the right-side CRT has one point highlighted. Your HUD's INS Waypoint Direction Indicator steers you toward the *highlighted* waypoint.

To select a new destination, tap the *Select Way Pt* key. Then use the *Last Point* and *Next Point* keys (among the *Waypoints* controls) to move the highlight up and down the list. As you move the highlight the HUD's INS Direction Indicator moves accordingly.

Changing Waypoints: To change a waypoint to a new location, first tap the *Change Way Pt* key. Then use the *Last Point* and *Next Point* controls to select the waypoint you wish to move. Finally, use the keypad waypoint keys to actually move the point.

To observe the results, make sure to tap *CRT Maps*. This sets the left-side CRT to the satellite/radar map. Then use the *UnZoom* key as necessary to show the entire course. Notice that as you move a waypoint the flight paths adjust accordingly.

Tap the *Reset Way Pt* key to reset all waypoints to the original (default) waypoints described in "Concept" above.

INS "Waypoints" System

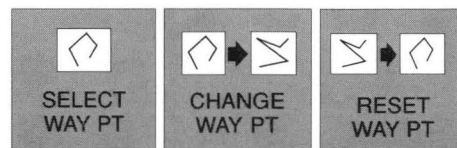

Waypoints CRT Screen

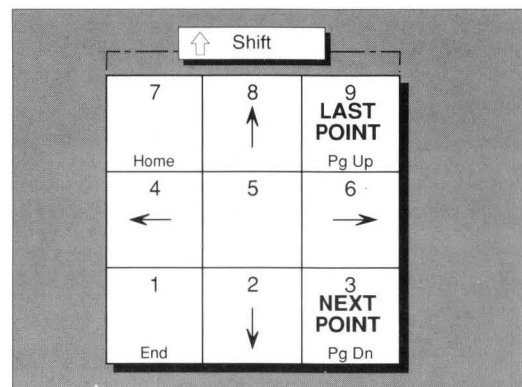
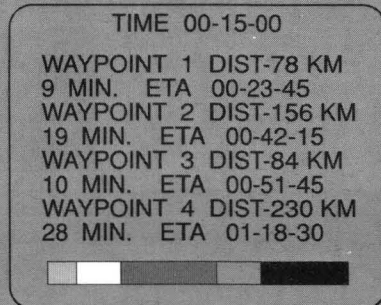

Fuel

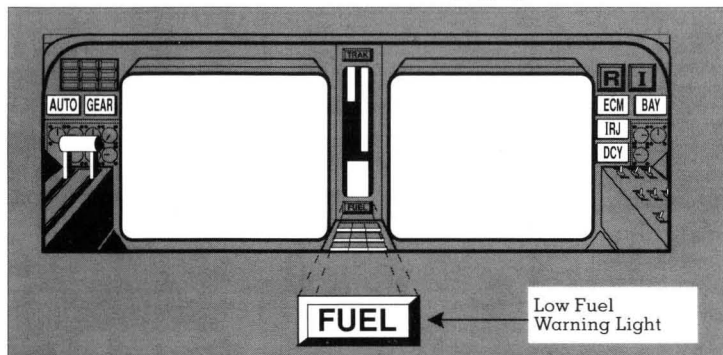

Fuel Warning: The "FUEL" light on the cockpit control panels goes on whenever your fuel tanks are low.

Extra Fuel: If you are carrying extra fuel in your weapons bay, you can pump that fuel from the bay into the main tank by tapping the *Select Ordnance* key until "EXTRA FUEL" appears on the lower left of the HUD. Then tap the *Fire Ordnance* key to move the fuel from the bay into your main tanks.

ILS (Instrument Landing

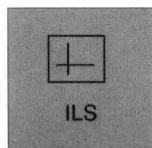

The *ILS* key toggles the ILS (instrument landing system) display on and off your HUD. When the ILS is on, a vertical and horizontal bar guide you toward the nearest friendly airbase.

Principles of Operation: The ILS is designed to aid you "on final", steering you down the descending "glide path" to the runway. If you are flying a pattern to land, use the ILS to guide you to the airport, then turn it off until you are "on final."

The ILS guides you to the runway or carrier deck, but ends there. Rather than produce inaccurate readings over the runway, the ILS automatically turns off before it degrades to being useless.

Vertical "Course" Bar: To use the ILS, fly the plane so that the vertical bar lines up with your HUD Nose Indicator. This means you're on course toward the airbase.

Horizontal "Glide Slope" Bar: The horizontal bar of the ILS represents the "glide slope", an imaginary line extending from the airbase up into the sky.

If the bar is above your HUD Nose Indicator, you are beneath the glide slope. You can either fly straight ahead until you "intercept" it, or climb to get to the glide slope faster.

If the bar is beneath your HUD Nose Indicator, you are above the glide slope. You should descend until the bar crosses directly through the HUD indicator.

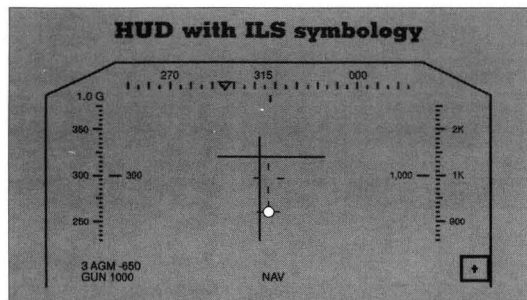

Mission Summary & Success



Tap the *Mission* key to display a short summary of your mission on the right-side CRT.

When you accomplish your primary or secondary mission, the mission summary is updated to show this. Therefore, if you're uncertain whether you hit the target, just check this display.

Tap the *Eject* key to “punch out” of your plane. Your F-19 has a zero-zero ejection seat, the safest and most flexible design available. Ejection is never entirely safe, but your best chance of survival exists if your altitude is between 2,000' and 14,000' while you are flying level or slightly climbing.

To prevent sensitive technology from falling into hostile hands, you should eject far out over open sea whenever possible. If not, bail out in friendly territory where you can. Ejections while over enemy coastlines or inland territory should be avoided at all costs.

These instructions only give the bare rudiments of how to operate each weapon. Many important secondary considerations (like not launching some too low) and tactical tricks are described in “How to Fight” (pages 56-63) and “Techniques & Tactics” (pages 78-97).

See “Equipment, USAF Ordnance”, page 131, for a chart that indicates which weapons are most effective against which targets. Further details about each weapon can be found on pages 140-146. The Ordnance currently available always appears in the lower left corner of the HUD.

Cannon: Your 20mm cannon is always available for use (unless out of ammo or damaged).

Ordnance: Tap the *Ordnance* key to display your weapons bay equipment on the right-side CRT. This includes both names and illustrations of all weaponry, cameras, fuel, etc. The ordnance currently selected is highlighted. The current armament also appears in the lower left of the HUD.

Tap the *Select Ordnance* key to change the weapon “locked into” your fire control system. Each keypress changes you to the next item in a weapons bay.

If your HUD is in AIR-AIR mode you can track aircraft targets. If your HUD is in AIR-GROUND mode you can track ground targets. The F-19 uses a zoom TV system with backup thermal imaging. Although the most useful and flexible system available today, it is limited to about 80 to 100 kilometers maximum range in daytime, less at night.

Tracking Camera: Tap one of the *Cam* keys to lock your target tracking camera onto the nearest target within 80-100 km ahead of your plane. A zoom-TV view of the target appears in the right-side CRT, including the target’s name, range, and bearing.

Primary and secondary objectives are listed as such. Civilian targets (which you shouldn’t hit in Cold War or Limited War situations) are noted also.

Normally you’ll use the *Cam Ahead* key to track a target in front of you. This is because all your weapons are forward-firing. However, you can use the *Cam Left*, *Cam Right*, and *Cam Rear* as well, although weapon launches are unlikely to hit the target.

Tracking Box: On your HUD the target is framed by a colored box (see the Technical Supplement for the meaning of various colors). If the box is invisible

Bailing Out

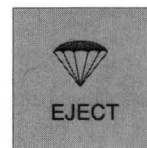

Weaponry

Selecting Weapons

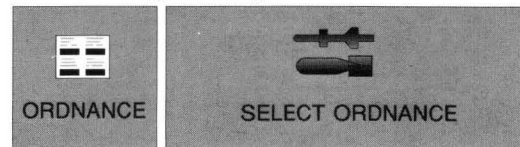

Tracking Targets

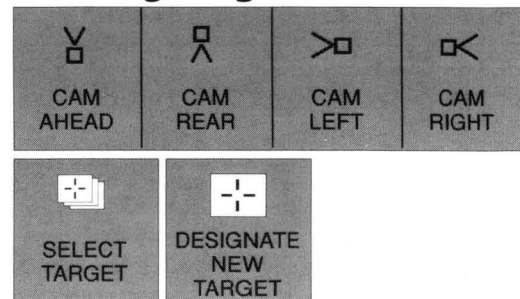

F-19 TV/FLIR Camera Coverage Arcs

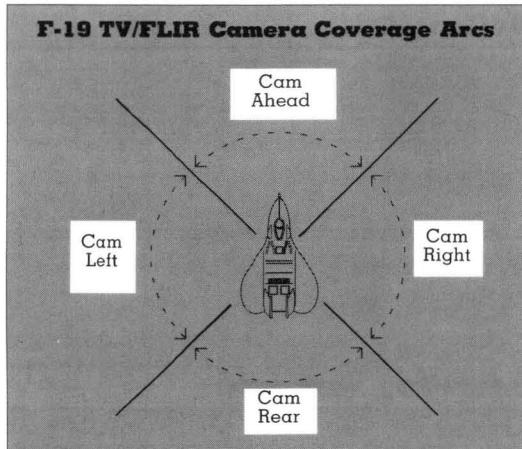

on the HUD, but you have an image on right-side CRT, the target is not directly ahead of you.

The color of the target box indicates whether the target can be hit with the current ordnance selected from the bay. The size of the box indicates the potential effectiveness of the weapon (a small box means poor effectiveness, a large box means superior effectiveness).

Note: If you have the weapons bay open and selected the 135mm/IR recon camera as your current weapon, the right side CRT shows the view through the fixed recon camera rather than the normal tracking camera. Close the weapon bay or select a different weapon to see the tracking camera view.

Target Data: Your F-19 has an onboard computer file of data on common targets for that region. Tap the *Data* key to get additional information about the current target.

Changing Targets: The onboard computer has a pre-programmed list of possible targets in the region, including your primary and secondary targets. Tap the *Select Target* key to move the tracking camera to the next nearest target within 80-100 kilometers.

Designating New Targets: In addition, you can reprogram the tracking camera to aim at any target on the ground. Simply aim your nose at the target and tap the *Designate New Target* key. The camera will lock onto the nearest new target.

Due to a limitation in your onboard computer, you can only designate new targets ahead of your aircraft. When you select this option the tracking camera automatically switches to the view ahead.

Firing Weapons

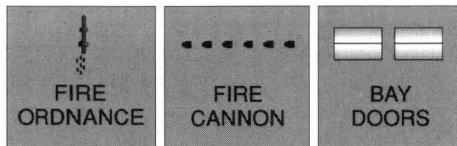

See "How to Fight", pages 57-60, for specific instructions on launching ordnance. Also see "Air-to-Ground Tactics" (pgs 78-88), "Air-to-Air Tactics" (pgs 89-97), and "USAF Ordnance" (charts on pgs 129-134, detailed descriptions on pgs 135-146).

Cannon: The *Fire Cannon* key (or button) fires one burst. Your 20mm cannon is always available for use (unless out of ammo or damaged).

Weapons Bay Doors: Before using ordnance you must toggle open the weapons bay doors, using the *Bay Doors* key. The "BAY" cockpit light flashes when the bay doors are open.

After you have launched the ordnance you should toggle the doors closed again (tap the *Bay Doors* key once more).

Launching Ordnance: Tap the *Fire Ordnance* key (or button) to launch a weapon. This fires one missile or drops one bomb. The weapon currently selected is the one used.

Reconnaissance Cameras (the 135mm/IR Camera) are "fired" like a weapon from an open weapons bay. Each "shot" takes one picture.

Special Equipment can be airdropped by opening the doors and "firing" it out. It floats to the ground using a parachute. It is also loaded or unloaded on the ground at appropriate airstrips automatically (a message appears on your HUD when loading or unloading is complete).

For detailed information on the concepts of stealth aircraft, enemy weapons, and appropriate defensive tactics see Part 3 ("Techniques & Tactics", pgs 74-97) and Part 5 ("Equipment", pgs 129-156).

Evasion & Defense

This gauge shows the "stealthiness" of your aircraft.

Your EMV: The "visibility" of your plane to enemy radars appears as a bar rising from the bottom of this gauge. Your visibility increases as you climb to a higher altitude, increase speed, open bay doors, lower gear, or use jammers.

Enemy Radars: The bars coming down from the top of the scale are incoming enemy radar signals. Ground-based radars appear on the left, aircraft radars on the right. The bar color represents whether the radar sees you or not (see the Technical Supplement for a color key). Bar colors match the radar arc colors that appear on the Satellite/Radar map (on the left-side CRT).

Search Warning: Enemy search radar detects your plane when the enemy radar strength bar overlaps your EMV bar, on the EMV scale. Search radar appears as a round, expanding circle on the Satellite/Radar map (on the left-side CRT).

The enemy radar symbols changes color on the EMV scale. The Satellite/Radar map also shows these color changes. See the Technical Supplement for the radar color key).

Frequently a single search detection does not give the enemy sufficient data to recognize your plane. A message on the HUD warns you when repeated detections indicate the enemy has "found" your plane.

Tracking Warning: Long-range and medium-range SAMs must track a target with radar before firing. Tracking radar appears as a short, narrow arc on the Satellite/Radar map.

When the enemy tracks you, the "TRAK" warning is lighted in the cockpit.

Some short range enemy missiles do not use a radar tracking system. Therefore, "TRAK" is not a foolproof warning of impending attack.

Missile Warning Lights: If a radar-homing missile is launched toward you, the "R" missile warning light flashes in the cockpit. If an IR (infrared) homing missile is launched toward you, the "I" missile warning light flashes.

EMV (Electro-Magnetic Visibility) Scale

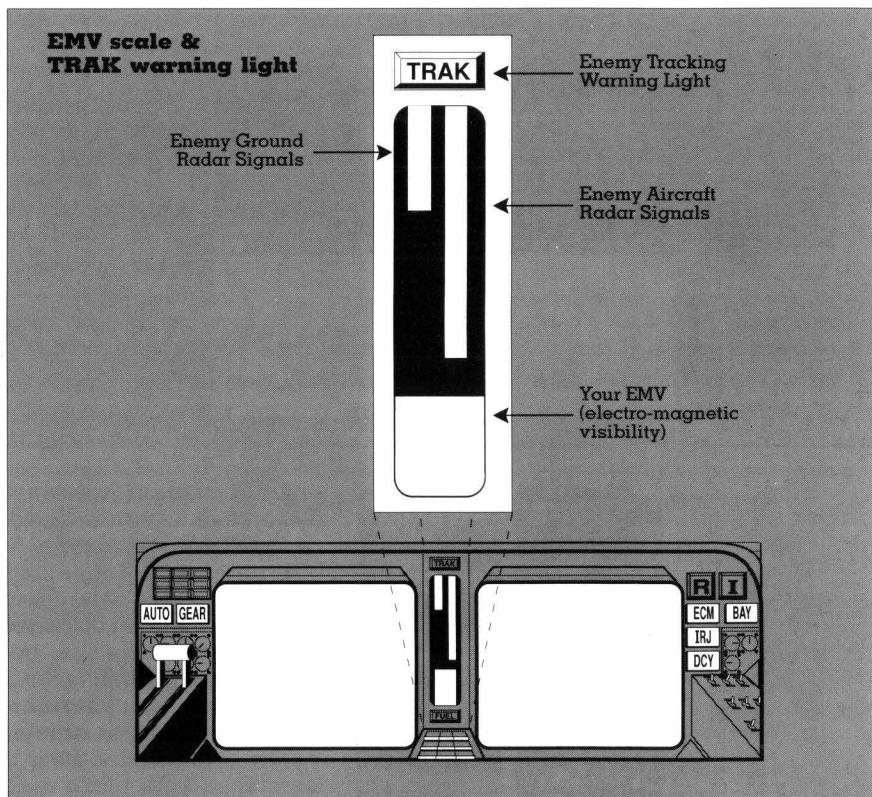

Warning Devices

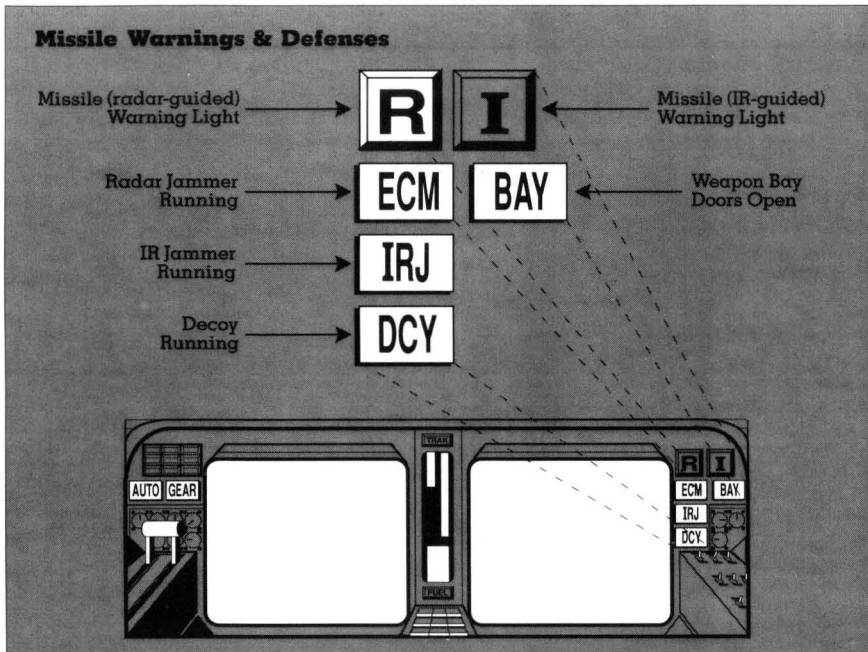

The appropriate light continues to flash as long as the missile is homing on your plane. If jammers or some other device confuse the missile, the light goes off. If the missile later finds you again and starts homing once more, the light begins flashing again.

If two or more missiles of the same type are homing on you, that light continues to flash as long as any missile is homing.

Missile warning lights are very important, since they're the only way to tell what kind of missile is attacking. The type of attacking missile (radar or IR) determines what sort of defenses you should use.

Missile Proximity Klaxon: When a missile approaches within a few seconds flight time of your plane, the proximity klaxon goes off. This very loud signal means you must do something, immediately, or you'll be hit soon. Typically you'll drop a chaff or flare cartridge, depending on the type of threat (chaff for radar missiles, flares for IR missiles). However, you should also make some last-minute maneuvers, especially if under attack by missiles with doppler radar guidance systems.

Missile Defenses

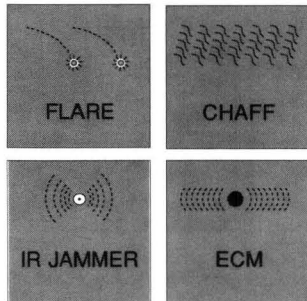

ECM (radar) Jammer: The *ECM* key toggles this device on and off. When the jammer is running the cockpit "ECM" light is on.

The ECM radar jammer "blinds" radar-guided missiles. Their missile stops homing on your plane and just flies straight ahead. The jammer is very effective against older "beam rider" (command guidance) radar homing missiles, but only good at long ranges against advanced "semi-active" radar homing missiles. These can "burn through" your jamming at short range.

When the ECM jammer is running your EMV is much larger.

IR (infrared) Jammer: The *IR Jammer* key toggles this device on and off. When the jammer is running the cockpit "IRJ" light is on.

The IR jammer "blinds" IR (infrared) guided missiles. They missile stops homing on your plane and just flies straight ahead. The jammer is highly effective against older "first generation" IR missiles, but only good at long ranges against advanced "second generation" missiles.

When the IR jammer is running your speed is reduced. In addition, the jammer cannot run for long periods. When it gets too hot it shuts down automatically!

Chaff: Tap the *Chaff* key to release one chaff decoy cartridge into the sky

behind your plane. For the next two or more seconds most enemy radar-guided missiles will home in on the chaff instead of your aircraft (but see page 88).

Important Exception: Enemy doppler-radar guided missiles will not home on the chaff unless your course is perpendicular (at right angles to) the missile. As long as the missile chases you from the rear, or attacks from straight ahead, chaff has no effect on doppler radar missile.

Flare: Tap the *Flare* key to release a flare decoy cartridge into the sky behind your plane. For the next two or more seconds all enemy IR (infrared) guided missiles will home in on the flare instead of your aircraft.

Your F-19 carries only three decoys. To launch a decoy, tap the *Decoy* key. The "DCY" light in the cockpit turns on, and remains lighted while the decoy is running.

Each decoy is a computer-controlled radar emitter and reflector, plus IR source. To enemy radar and infrared it looks just like your plane, only stronger. The decoy gradually floats down under a parachute. It self-destructs before hitting the ground.

Enemy missiles, aircraft, and ground radars are all fooled by decoys, although the amount of time depends on the experience and skill of the opposition (time typically varies from 15 to 60 seconds). During this time the enemy chases and attacks the decoy instead of you.

The upper left of the cockpit has a bank of "telltale" lights that indicate which systems (if any) are damaged. See the Technical Supplement for the layout and color-coding of these telltales.

To see a detailed display of your F-19, with all systems and their status, tap the *Damage* key. The display appears on the right-side CRT.

RWR / IWR: The Radar Warning Receiver and IR Warning Receiver are inoperative. The "R" and "I" warnings of approaching missiles will not work.

Engines: Engine damage reduces the maximum thrust possible. Additional damage anywhere on the aircraft further reduces thrust.

Flight Controls: Control surface damage makes the plane more difficult to control.

Avionics: Avionics damage means the INS system is malfunctioning, so waypoints are no longer available. In addition, the autopilot is disabled, since without an INS it cannot function.

Bay Doors: The ordnance bay doors are damaged and jammed open. Your EMV is permanently increased.

Jammers: The ECM and IR jammers are inoperative.

Fuel Tanks: Damage and stress breakage is causing fuel to leak. Once a leak starts, any further damage, anywhere on the aircraft, increases the rate of fuel loss.

Decoys

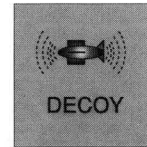

Damage

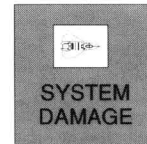

Random Malfunctions

Your F-19 is an extremely complicated piece of equipment. Random malfunctions are possible in any of the systems at any time. The malfunction may include the reporting systems on board the craft. If so, you won't know that something has malfunctioned until you discover it doesn't work!

Malfunctions are more likely in intense combat situations, due to the heavy burden that places on your sophisticated electronic systems.

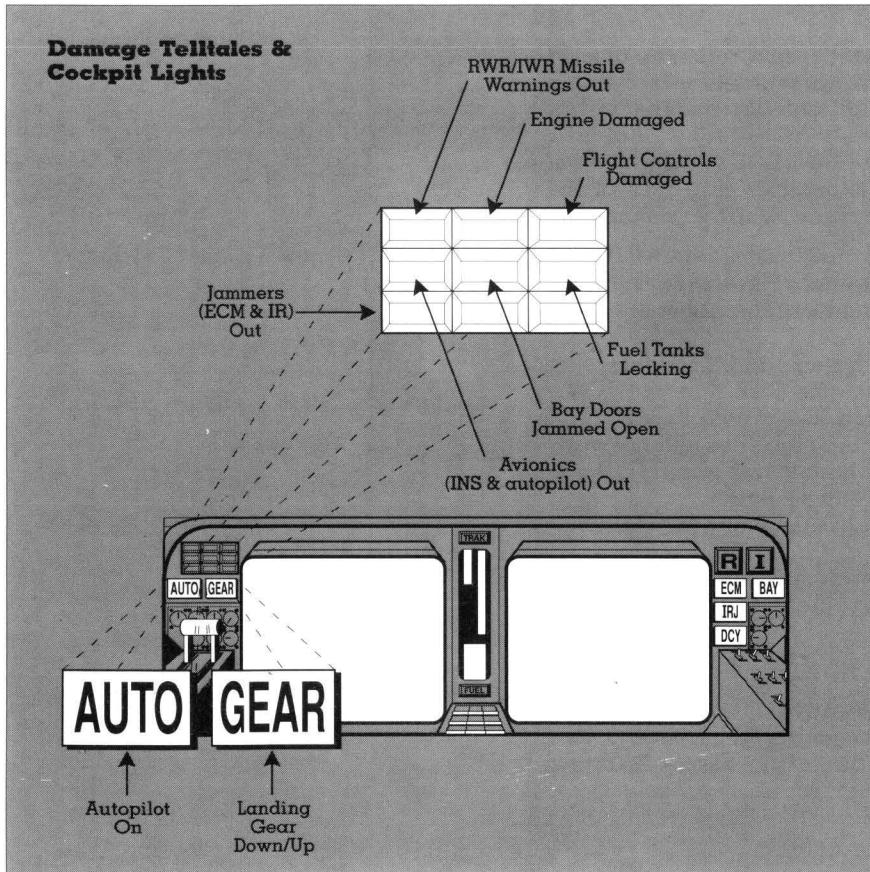

How to Fly

This section only provides the rudiments of flying. For a more in depth description see "Aerodynamics & Flight" (pages 69-73).

The preflight checklist for your F-19 Stealth Fighter is:

1. Check your INS system. Display the satellite/radar map on your left-side CRT (using the *CRT Maps* key), and the INS waypoints on the right-side CRT (using the *Select Way Pt* key). Look up on the HUD and note on the heading indicator the location of the INS Direction Indicator. Fly in this direction to reach the first waypoint. Advanced pilots often adjust their waypoints at this time.

2. Check Armament: Check your ordnance (tap the *Ordnance* key) on the right-side CRT. Use the *Select Ordnance* key to toggle through the weapons. Note the active weapon is in the lower left corner of the HUD.

3. Extend the Flaps by tapping the *Flaps* key. Note the "FLAPS" indicator in the lower right corner of the HUD. Flaps give you more lift during takeoff.

4. Check the Catapult System (on Aircraft Carriers only): When launching from an aircraft carrier, the brakes must start set (i.e., "on"). This represents attaching the aircraft to the deck's steam catapult. If the HUD does not show "BRAKE" in the lower right corner, tap the *Brake* key to set the brakes and engage the catapult.

5. Start the Engines: Turn on your engines by tapping the *Max Pwr* key.

6. Activate Catapult (on Aircraft Carriers only): First wait until the bar gauge on the throttle (left side of the cockpit) shows maximum power. Then tap the *Brakes* key. This releases the brakes and catapult, hurling your off the deck.

7. Accelerate Past Stall Speed: As you move down the runway or carrier deck, watch the speed scale (left side of the HUD) very carefully. A colored bar on the side of that scale will gradually go down. This is the Stall Speed Indicator. When the bar drops below the center tick-mark on the scale your plane is past stall speed. This happens very quickly on a carrier deck, and somewhat slower on a runway.

8. Climb into the Sky: Pull back gently on the stick. Watch the altitude scale on the right side of the HUD: you'll start climbing.

9. Retract Landing Gear: Tap the *Gear* key to retract your landing gear. Don't leave the gear down — both it and your plane can be damaged if left down at too high a speed.

10. Retract Flaps: Tap the *Flaps* key to retract your flaps. You no longer need the extra lift.

11. Turn onto Course: Pull the control stick left or right until the INS Direction Indicator along the top of the HUD matches up with the center tick of the Heading scale. Since this is a stealth mission, you'll want to stay low. About

Takeoff

200' to 500' is ideal.

Alternatively, you can simply tap the *Autopilot* key and let your autopilot turn you onto the correct course to the first waypoint.

Flying Techniques

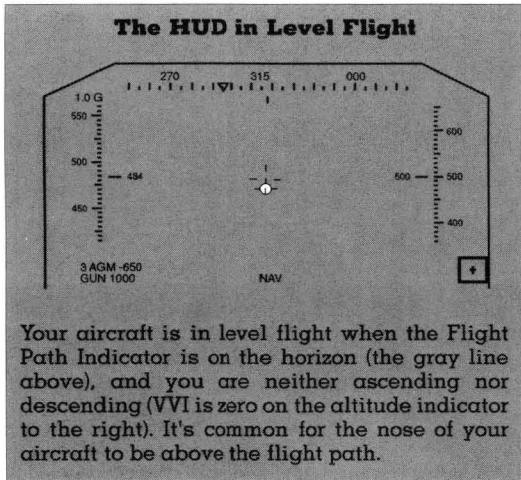

Your aircraft is in level flight when the Flight Path Indicator is on the horizon (the gray line above), and you are neither ascending nor descending (VVI is zero on the altitude indicator to the right). It's common for the nose of your aircraft to be above the flight path.

A Light Touch: Use a light touch on your *Control Stick*. The most common pilot error is a "ham-fist" on the stick, throwing the plane around the sky in uncontrolled abandon. That kind of heavy-handed flying may be fun in a dogfight, but it's totally useless for lining up a bombing run, or making a landing. Unless it's an emergency never "peg" your control stick (push it to the limit).

Chasing the Gauges: When you change an aircraft's operating regime, by moving the stick, changing the throttle, etc., the effects of the change don't happen instantly. It takes a second or two for your gauges and displays to "settle out" and show the new situation. For smooth flying a pilot always makes a change, then observes the effects. Constant adjustment and correction should be avoided, because all you'll do is "chase the gauges", overcorrecting every move.

Straight & Level Flight: To be a good combat pilot, you need to master level flight. Do this in a training scenario, rather than real life.

To learn level flight, climb to an altitude above 500' (say 2,000', or 2K on the HUD altimeter). Now level the aircraft so the nose of the plane points at the horizon. Next reduce the throttle to about 75% to achieve an economical cruising speed.

Although the cross-hair nose indicator on the HUD may appear level with the horizon, a glance at the HUD's altimeter and VVI will probably show that the plane is gradually climbing or descending. If you're gradually climbing, push forward a tiny bit on the *Control Stick* (pitch down), then let go and see what happens. If you're descending pull back (pitch up) a bit instead. Your objective is to keep the altimeter rock steady. You'll notice that your flight path indicator aims at the horizon, but your nose indicator may be pointed above or below it, depending on your speed. Generally, the slower you're travelling, the higher you must pitch the nose up to achieve level flight (i.e., to place the flight path indicator on the horizon).

Now experiment. Tap the *Brakes* key. This slows down your plane. Watch the HUD and notice how the flight path indicator drops down. Meanwhile, on the sides of the HUD, your speed is dropping (no surprise, with the brakes on!) and so is your altitude. To achieve level flight at this new, lower speed pitch up (pull back on a stick a tiny bit) until the flight path indicator is level with the horizon. You may need to adjust once or twice to find the setting.

This adjustment of pitch to achieve level flight is called changing your "angle of attack" (the angle at which your wings slice through the air). See "Aerodynamics & Flight", page 70, for a detailed explanation.

Turns: As your roll angle (when turning right or left) increases beyond 45°, your stall speed rises from the normal 120 knot range to over 200 knots (in a 90°

roll). Since tight turns often “bleed off” airspeed, a long, tight turn can reduce your airspeed below the stall speed. Keeping an eye on the airspeed and stall speed is especially important when making tight turns at low altitude. If you’re only a few hundred feet from the ground, a stall means a crash!

In very tight turns (where you roll 80°, 85°, or even 90°), once in the turn you can tighten your turn rate by pulling back on the stick (i.e., pitching up the nose). However, this trick bleeds off airspeed even faster, so keep a close eye on the stall speed bar (on the HUD airspeed gauge).

Loops are easy in your F-19 Stealth Fighter, but ballistic (“straight up”) climbs can only be maintained for short periods: the engines are insufficient for a prolonged ballistic climb.

Remember that any prolonged vertical maneuver greatly reduces airspeed, which risks a stall if you didn’t start the maneuver with a lot of speed. However, going vertical is very handy for changing direction, since you can roll while vertical, quickly pointing your nose in the desired direction, then push down into level flight again.

Low Altitude Flying: At altitudes under 500 feet you can expect increased buffets, downdrafts and other irregularities that make flying difficult. Also beware of low ridges and mountains. It’s easy to fly into a mountain if you’re not looking. Good pilots develop a “cross check” routine of scanning the entire HUD periodically, to make sure everything is okay.

In “No Crash” and “Easy” flight options you have a barometric/laser altimeter. If you drop below 200’ this device automatically but gently pushes your plane above 200 feet. Be warned, the device does automatically turn off when the landing gear is down, or when the gun is firing. The device is not proof against power dives, stalls, or other radical maneuvers, but works fine in normal flight regimes.

In fully realistic flight the automatic altimeter that keeps you above 200’ is turned off. This allows a skillful pilot to cruise at even lower altitudes.

Airbases: All ground runways and aircraft carriers have a north-south orientation and a center stripe down their middle. On approach a course of 000 (if coming from the south) or 180 (if coming from the north) will aim you directly at the runway.

Airbase runways are more than twice as long as your safe landing distance at 200 kts. You have a large safety margin.

Aircraft carriers have arrestor wires near the stern. You must touch down before or on these wires, which catch and stop your plane. If you miss the wires you will roll off the deck (your brakes aren’t good enough to stop the plane in such a short distance). Do not attempt to land on the bow of an aircraft carrier. There are no arrestor wires there. Furthermore, regular aircraft spotted for launching may be positioned there. You don’t want to crash into them!

The ILS glide slope (see below) for aircraft carriers is steeper. In fact, some pilots refer to a carrier landing as a “controlled crash”.

Runway Layouts

USN Aircraft Carrier Deck Plan

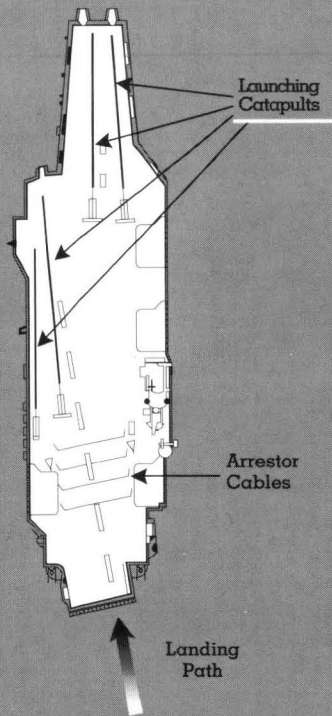

Typical NATO Runway Layout

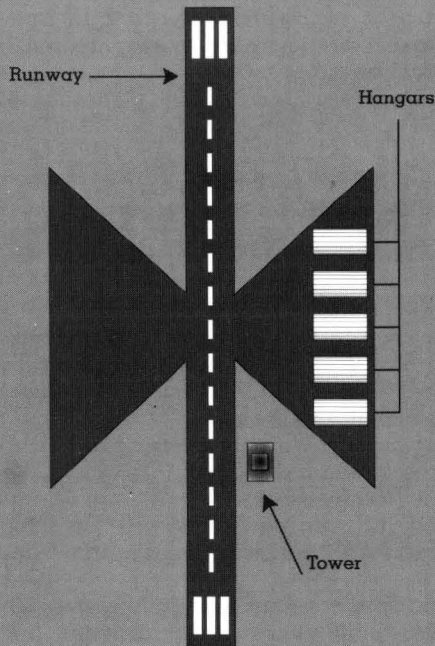

Aborted Landings: If you get in trouble landing, open the throttle to full power, then retract the flaps and landing gear. Climb away and come around for another try. Do not make wild movements with the control stick while landing or aborting. Wait for your airspeed to exceed 300 knots before making any big turns or similar maneuvers. Until then, gross maneuvers with the control stick may stall the plane, causing a fatal crash.

To use the ILS, switch the HUD to NAV mode (tap the *HUD Modes* key as necessary), turn on the tracking camera (tap the *Cam Ahead* key), and tap the *ILS* key. The ILS and camera will automatically track the nearest friendly or neutral landing site. It will not track on rough airstrips behind enemy lines; there you must land without ILS aid.

Concept: The ILS symbols represent your position in relation to the "glide slope". The glide slope is an invisible

"beam" that angles out and up from the end of the runway. Approaching from a distance (say, 50 km away) you first fly beneath the glide slope and turn onto its bearing. Then you follow it toward the airbase, eventually intercepting it. Then you follow it down to the airbase.

Line Up Your Approach: The first step is to line up on the correct course to the airbase (or aircraft carrier). To do this, fly at 500' to 1,000' (1k') to a point about 40 to 50 km north or south of the base and turn until the ILS vertical bar is centered on your HUD's nose indicator.

If the horizontal bar is above the HUD's nose indicator, you are flying beneath the glide slope (the bar represents the position of the glide slope). This is correct. Since all airbases and carriers are north-south oriented, your course should be either 000 or 180.

If the bar is beneath your nose indicator, you are flying above the glide

Using the ILS (Instrument Landing System)

Using the ILS (Instrument Landing System)

ILS on HUD

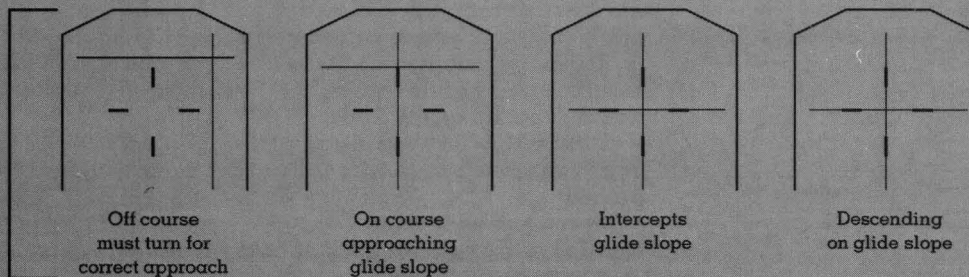

Top View

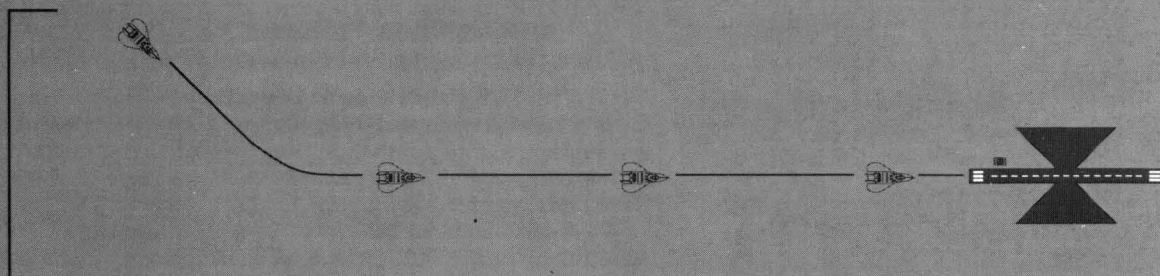

Side View

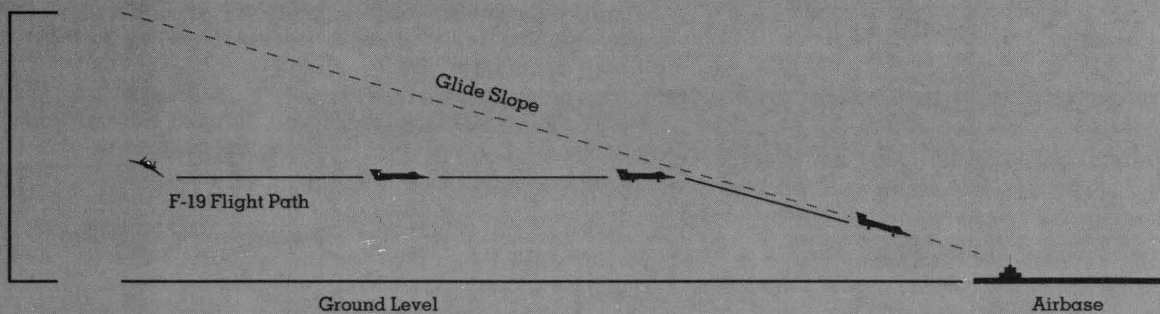

slope. You are either too high or too close to the airbase, perhaps both. Fly away and/or lower and try again.

Intercept the Glide Slope: Once you are beneath the glide slope (vertical bar centered, horizontal bar high), fly along this course. The horizontal bar should gradually drop down, until it too is centered. When the horizontal bar is centered, you are now intercepting (flying through) the glide slope.

As you fly your course to the intercept, you should prepare for landing by reducing the throttle (see below). Using this "straight-in" approach, you can now extend (open) the flaps.

Descent: When you intercept the glide slope, begin your landing descent. You want to keep the horizontal bar centered, which means making a gradual descent.

You must manage the descent like a normal landing (see below). This means opening flaps, extending the landing gear, reducing the throttle, and making small pitch-up adjustments to maintain the correct descent speed.

Touch down: The ILS will not guide you to touch down. It is not accurate in the immediate vicinity of the base. It turns off automatically before you reach the runway.

ILS and Landing Patterns: The ILS is designed to guide you to the airbase. It does not control your plane through a landing pattern.

Straight-in Landing

1. The ILS (Instrument Landing System): First use the ILS to line up onto a correct approach (see above). Beginners should plan to intercept the glide slope (i.e., get onto their approach) about 40 km to 50 km from the runway. Attempting to find the approach and make a landing less than 20 km from base is not advised for beginners.

2. Approach at 300 kts: Fly your approach at 500' to 1,000'. Reduce the throttle to about 70%, which should reduce your speed to about 300 kts. Eventually you'll need to pitch up (raise the nose) a little to maintain level flight.

3. Level flight at 300 kts (throttle 70%): As you approach in level flight, reduce your throttle until the airspeed shows 300 knots (about 70% throttle). You'll need to raise the nose 5° to 7° maintain level flight until you're about 20 km from base.

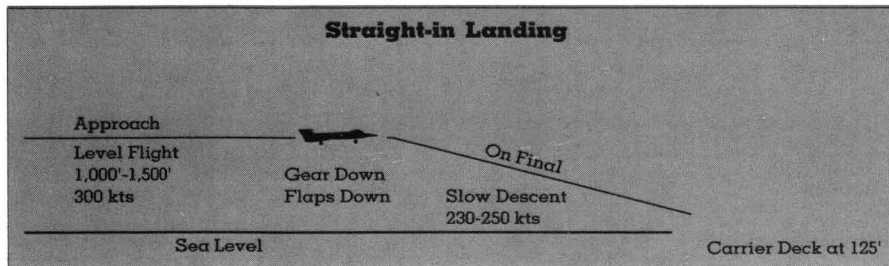

4. Flaps Out, Throttle 50%, Gear Down: Now extend the flaps and reduce the throttle to about 50%. This slows the plane to about 230 kts. As you reach this speed, lower your landing gear. If you're moving too fast, extend the brakes (tap the Brake key) for a brief period, then retract them again.

5. Descend 'On Final': When the ILS' horizontal bar reaches the middle of the

HUD nose indicator, you should start descending down the glide slope.

There are two methods for descending. One is to reduce the power slightly. If you were in level flight, but now have less thrust, you will gradually descend. This method is generally preferred by pilots, but in a hot jet like the F-19 it takes effect very slowly.

The other method is to reduce the pitch of the nose slightly. Typically you're landing with the nose pitched up about 5° to 7°, to maintain level flight at low power. Therefore, reducing this upward pitch a few degrees will cause a gradual descent. Do not point the nose down and dive for the runway.

In either case, your nose should always have a positive pitch (i.e., the HUD nose indicator should be above the HUD flight path indicator).

Use the ILS horizontal bar to control your rate of descent. Adjust the throttle or pitch (depending on your technique) to keep the bar in the middle of the HUD's nose indicator. A good pilot will set up his descent rate as he enters the glide path and leave it untouched as the plane gradually descends.

Finally, keep an eye on your airspeed and the stall bar. If the stall bar indicator gets too close to your current airspeed (within 25 kts), your throttle is too low or you're flying with brakes on. Increase the throttle or take off the brakes. Conversely, if you're moving too fast (over 250 kts), extend the brakes (tap the *Brake* key) for a brief period, then retract them again.

6. Touch Down: Your altimeter will read an altitude of 0' on a runway, and 125' on an aircraft carrier deck. These are your "touch down" altitudes. The safe touch down vertical velocity is shown by an arrow on the VVI portion of your HUD altimeter. A VVI of 400'/minute or less (4 ticks on the scale) is always safe. In certain conditions a higher VVI is allowable.

The easiest and safest touch down is simply to gradually continue the descent until you're on the runway. Then cut the power (tap the *No Pwr* key) and engage the brakes (tap the *Brakes* key).

Aircraft Carriers: Landing on a carrier is slightly more difficult, since you must touch down in the arrestor cables area. To avoid overshooting the cables, increase your descent by lowering the nose a little extra, then at the last second extend the air brake (tap the *Brakes* key) as you pull the nose back up a bit.

If you miss the carrier's arrestor cable area, don't bother trying to touch down. Instead close the brakes (if you opened them earlier) and hit maximum throttle (tap the *Max Pwr* key). Since your nose is pointed up, you'll climb upwards again.

How to Fight

This section provides a short primer is how to engage the enemy, and how to defend yourself from their attacks. For more information see "Techniques & Tactics", pages 74-97.

Firing Procedures

Hitting the Target

See "Aircraft Controls, Weaponry" (pages 43-44) for a detailed list of each weapon control.

(1) Find the Target: The world is a very large place. Fortunately, your primary and secondary targets are stored in the memory of your INS. Initially your #2 waypoint is always the primary target, #3 your secondary target. If you've changed the waypoint positions, you can recover the initial default by pressing the *Reset Way Pt* key.

To reach to the target easily, call up the waypoints (press the *Select Way Pt* key), step by keypress down to the appropriate point (#2 or #3) using the *Next Point* key, then steer toward it using the INS Direction Indicator on the HUD's heading scale.

(2) HUD: Change the HUD to the correct mode. Use the *HUD Modes* key to select the right mode: NAV (for takeoffs and landings), AIR-AIR (for firing at aircraft), or AIR-GROUND (for firing at everything else).

(3) Camera: Lock your tracking camera onto the target. Tap the *Cam Ahead* key to aim the camera at the nearest standard target ahead. The camera remains blank if there are no targets ahead within 80 to 100 km in daytime, less at night.

To see other standard targets, tap the *Select Target* key. However, the selection is limited to those "standard" targets in your onboard computer. This group always includes the primary and secondary target, of course.

To line up a target not in your onboard computer tap the *Designate New Target* key. The nearest target ahead is temporarily added to the computer's database. If you previously designated some other target, this new designation replaces that one. Once you've added a target, it remains in the computer, and becomes part of the group that "Select Targets" cycles through.

(4) Weapon Selection: Make sure you have the correct weapon selected. The size and color of the tracking box on the HUD indicates whether the current weapon is effective against that target. The larger the box, the more effective the weapon. See the Technical Supplement for the color key.

Press the *Select Ordnance* key to cycle through the weapons available in your bay. The 20mm cannon is always available (it has a separate firing control).

(5) Aim & Fire: Different weapons are aimed in different ways, described below. Depending on the weapon selected, make sure it is correctly aimed at

the target before you fire. See below for details.

(6) Results: Friendly AWACS aircraft observing your mission will report the results. Sometimes a hit will damage a target without destroying it, sometimes you may miss entirely, and other times a hit may be ineffective. Ineffective hits are caused by using the wrong weapon (your fault), or because the weapon was a dud.

See "Equipment, USAF Ordnance", page 131, for a chart that indicates the cannon's effectiveness against various targets.

Air-to-Air — Anticipation Firing: The tracking box on the HUD shows the enemy airplane that's your target. The range appears in the right-side CRT. Your maximum cannon range is 6 kilometers. Effective cannon range is about 3 km (beyond that shells miss frequently).

The moving gunsight shows the position your shells would be landing, assuming you fired in the past. This is called an "historical gunsight." It takes cannon shells about 1 second to travel 3 kilometers. The gunsight assumes shells will travel about 2 seconds (6 kilometers) unless you are tracking a closer target.

To fire, you must "anticipate" when the enemy and your gunsight will meet. At the appropriate time before that meeting you open fire. For example, if the enemy and your gunsight are converging and the range is 6 km, you should open fire 2 seconds before they converge. If you estimated correctly, they will converge just as your gunsight moves onto them.

Air-to-Ground — Walking Fire: Attacking ground targets is much easier, since they don't move. The easier way to score hits is by "walking" your fire over the target. Do this by opening fire about 6 km from target and observe where the shells hit the ground. Guide your plane to "push" the advancing explosions onto the target. Unfortunately, this technique consumes ammo rapidly unless you fire in short bursts, spaced well apart until .

See "Equipment, USAF Ordnance", page 131, for a chart that indicates which weapons are most effective against which targets.

Target Envelope: If the HUD is in Air-Air mode and an AAM is your current armament, a wide circle appears on the HUD. This is the target envelope of your missile's seeker head. The missile can lock on to enemy aircraft within this area, provided it's within range.

Oval lock-on: The tracking box on the HUD shows your target. When the tracking box becomes an oval, the missile is locked on and has a good chance of hitting. When the oval changes color, the missile has superior accuracy.

To fire, open the weapons bay (tap *Bay Doors* key) and then tap the *Fire Ordnance* key.

The 20mm Cannon

20mm M61A1 Vulcan Cannon

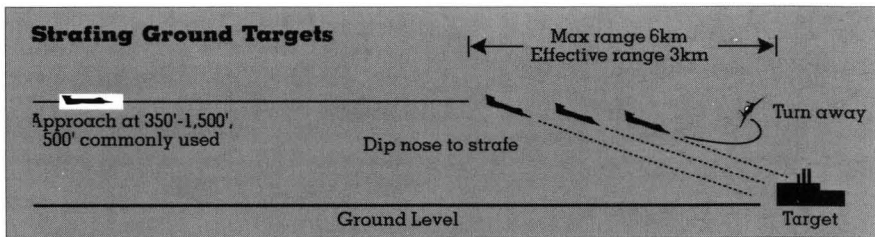
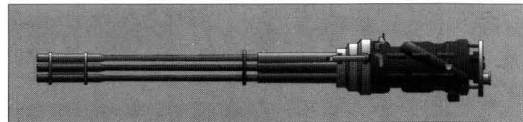

Guided Missiles

Air-to-Air Missiles (AAMs):

AIM-9M Sidewinder
AIM-120 AMRAAM

Air-to-Ground Missiles (AGMs):

Penguin-3 ASM
AGM-84A Harpoon
AGM-65D Maverick
AGM-88A HARM

Guided Missiles

Restrictions: Missiles drop about 300 to 400' from your plane when launched, depending on weight, etc. In addition, they drop away with whatever airspeed, climb rate, or dive rate your plane has. As a general rule, don't launch a missile below 500' or in a power dive — it may hit the ground before it can fly away! See part 5, "Equipment, USAF Ordnance", page 131, and the descriptions following on pages 140-142 for more details.

PAVE TACK Laser-Guided Bombs

GBU-12 Paveway
CBU-72 FAE
Mk 20 Rockeye II

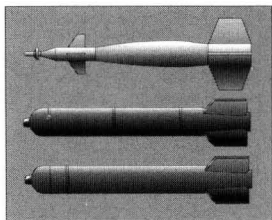

These weapons are essentially motorless missiles. They glide from your plane to a target "painted" by the PAVE TACK laser mounted on the bottom of your plane. See "Equipment, USAF Ordnance", page 131, for a chart that indicates which weapons are most effective against which targets.

Oval & CRT lock-on: The tracking box on the HUD shows your target. When the tracking box turns oval, the bomb is locked on and has a good chance of hitting. When the oval changes color, the bomb has superior accuracy.

You should always use the tracking camera (tap *Cam Ahead* key) with these weapons. When the box turns oval the "Missile Lock" crosshairs appear on the right-side CRT. If you are "toss-bombing" (see below) the HUD box/oval is often invisible, so the tracking camera message on the CRT is your only indication of lock-on.

Toss Bombing: The problem with glide bombs is that they travel about as fast as your plane. If you launch them from low altitude, they arrive at the target about the same time as your plane, and the resulting explosion can damage or destroy you.

Therefore, the standard attack technique is "toss bombing". Approach level, flying full speed at 500' altitude. At 3 km to 6 km from the target you pitch up into a climb (30° to 40°) and watch the CRT until lock-on occurs (see below). Then launch the bomb and turn away. You must keep the underside of your plane aimed at the target until the bomb hits, so don't make the turn too violent! For more details on toss bombing, see page 79.

To fire, open the weapons bay (tap *Bay Doors* key) and then tap the *Fire Ordnance* key.

Restrictions: Laser-guided bombs glide to the target; they have about 1 km of range for every 500' of altitude you have. The weapon explosion has a danger space of 3,000', so it's important that you gain enough distance or altitude to avoid being caught in the blast. However, you must keep the underside of your aircraft facing the target until the bomb hits. If not, the laser guidance for the bomb breaks and it will almost surely miss.

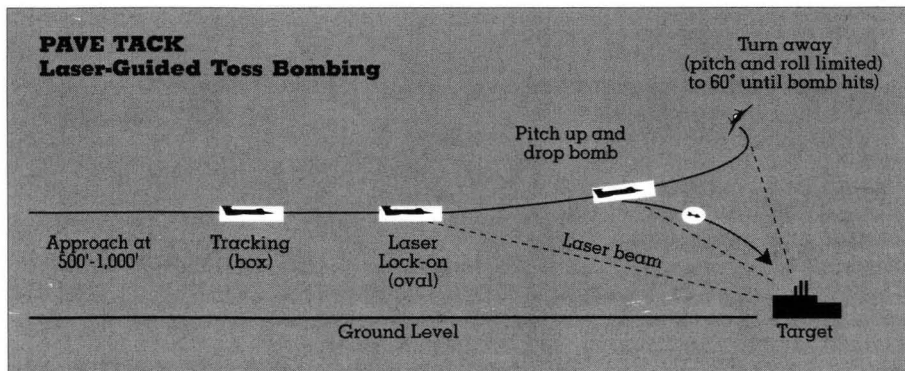

These are unguided bombs with special fins that slow them down very quickly. As a result, they rapidly fall behind your aircraft, allowing safer bombing at lower altitudes. See "Equipment, USAF Ordnance Charts", page 131, for a chart that indicates which weapons are most effective against which targets.

Level Bombing: In this standard technique for retarded bombing, you fly straight over the target at low altitude, releasing the bomb(s) according to the cues on your HUD. For details and tactics on level bombing, see page 00.

Flightpath Guide: Begin your bombing run by flying level above 500'. Turn to match your course (the flightpath indicator) to the diamond-shaped flightpath guide on your HUD.

You can be above or below the flightpath guide without losing accuracy, but being left or right of the guide will cause a miss.

Ranging Bar: As you approach the target, the ranging bar gets shorter and shorter. The cue to release a bomb is when the line becomes a single dot. You may wish to extend your brakes (tap the *Brakes* key) to make your bombing run slower and more manageable.

To Fire: Open the weapons bay (tap *Bay Doors* key) and then tap the *Fire Ordnance* key. If your brakes are extended, retract them immediately (tap the *Brake* key a second time) after firing to hasten your escape from the blast area.

Restrictions: The HUD bombing symbols flash if dropping a bomb could injure your aircraft. For example, this may occur early in a bombing run, before you climb above 500'. However, the computer predictions assume you continue to fly "as is". If you drop the bomb, then immediately turn up and away, you could drop a bomb within the "danger area" and escape.

As a general rule, it's very unsafe to drop retarded bombs below 500' altitude.

These are traditional bombs that arc down at high speed toward the target. See "Equipment, USAF Ordnance", page 131, for a chart that indicates which bombs are most effective against which targets.

Level Bombing: This is the easiest method of using free-fall bombs. Level bombing with free-fall bombs is essentially the same as using retarded bombs, except the minimum safe bombing altitude is 3,000' instead of 500'.

See page 00 for additional tactics and techniques, notably dive bombing.

Flightpath Guide: Begin your bombing run by flying level at 3,000'. Now turn to match your course (the flightpath indicator) to the flightpath guide on the HUD.

You can be above or below the flightpath guide without losing accuracy, but being left or right of the guide will cause a miss.

Ranging Bar: As you approach the target, the ranging bar gets shorter and shorter. The cue to release a bomb is when the line becomes a single dot. You may wish to extend your brakes (tap the *Brakes* key) to make your bombing run slower and more manageable.

Retarded Bombs

Mk 20 Rockeye
Durandal
Mk 82-1 Snakeye
Mk 35 Incendiary Cluster
ISC B-1 Minelets

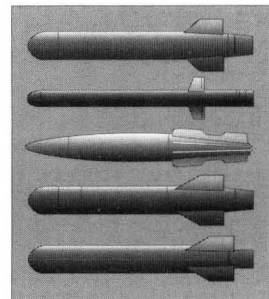

Free-fall Bombs

Mk 82-0 Slick
Mk 122 Fireye

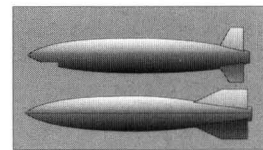

Bombsight Fall-line & Bullseye: In level bombing the fall-line indicator usually extends off the HUD, with the bullseye out of sight below.

To fire, open the weapons bay (tap *Bay Doors* key) and then tap the *Fire Ordnance* key. Then immediately turn away. Don't fly over the target, since you could be caught in the explosion. If your brakes are extended, retract them immediately (tap the *Brakes* key a second time) after firing to hasten your escape from the blast area.

Restrictions: The HUD bombing symbols flash if you're within the blast area of the bomb (within 3,000' of the predicted drop point). Do not drop the bomb unless you are confident you can escape the blast. As a general rule, you need 3,000' altitude when level-bombing with free-fall bombs.

135mm/IR Recon Camera

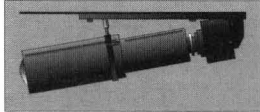

This is a reconnaissance camera mounted in the weapons bay that is fixed forward (unlike your target tracking camera, which moves):

Camera Operation: To configure your HUD and cockpit for camera operations, follow these steps:

- (1) Switch the HUD to Air-Ground mode (use the *HUD mode* key).
- (2) Selected the 135mm/IR camera as your ordnance (use the *Select Ordnance* key).
- (3) Aim the tracking camera at the target (use the *Cam Ahead* key, with the *Select Target* key if necessary).
- (4) Open the weapon bay doors (tap the *Bay Doors* key).

Taking Pictures: To take pictures, fly the plane so the small cross symbol passes through the center of the target box on the HUD. As this happens, you'll see the object pass through the lens on the CRT. As it does, hit the *Fire Ordnance* key once or more to take the pictures. You'll see a message on the CRT indicating a good picture (when and if you get one).

Special Equipment

Delivering or Picking Up Equipment: Finding the secret airbase and landing there is a major challenge. Secret airstrips have no ILS system — just a few flares at each end of the runway! Furthermore, the runway is very short: only half the length of the runway at a major airbase.

To pick up or deliver equipment at a secret airbase, land at the airbase. Equipment is unloaded or materials delivered to you automatically. A message in the HUD indicates when this occurs. Then you can take off again.

Airdropping Equipment: To airdrop equipment, open the weapon bay (tap *Bay Doors* key) and make sure the equipment is the current bay ordnance (tap *Select Ordnance* key until it appears in the lower left corner of the HUD). As you pass over the top of the radio beacon launch the equipment by tapping the *Fire Ordnance* key.

The minimum safe altitude to airdrop equipment is 500'. Try to avoid dropping it from altitudes above 1,000' (1K'), since the higher you are, the less accurate the drop.

Stealth & Defenses

Evading Detection

Keeping a Low EMV: The lower your EMV, the more difficult it is for enemy radars to spot your aircraft. To maintain a low EMV you must fly low and level. Your gear should be up and your weapons bay doors closed. The jammers should be off.

Enemy Radar Effectiveness: Enemy radars vary with terrain, range, and type (pulse or doppler). On most systems, color represents the strength of an enemy radar signal. See the Technical Supplement for the color codes used.

Terrain: Radar is most effective over open water or flat countryside. In wooded and rolling hills radar effectiveness is less, while in mountainous country radar effectiveness is greatly reduced. The lower the radar effectiveness, the weaker their signal. This weakening is visible on the EMV scale: the bars representing enemy radar signals become shorter.

Range: At very long ranges enemy radar is weak. As the range gets smaller, the radar becomes more powerful. Maximum range for a radar varies dramatically with the set. As enemy radars emit signals you can graphically see their ranges on the Satellite/Radar map on the left-side CRT (use *CRT Maps* key)

Pulse Radar: These radars are represented by dotted arcs on maps. Pulse radars are least effective when your nose or tail is pointing toward them, and most effective when your side points at them. Therefore a common tactic is to fly directly at a pulse radar, then just after it emits a signal make a tight turn and fly away from it again.

Doppler Radar: These radars are represented by solid arcs on maps; they are generally more powerful than pulse radars. Doppler radar is most effective when you are flying toward or away from them, and least effective when you keep a constant distance from it (i.e., your side points at it). Therefore a common tactic is to fly toward a doppler until just before it detects you, then turn and fly in an arc around it, keeping a constant distance.

The war situation (Cold, Limited or Conventional) determines the Rules of Engagement (ROE) in force. In Cold or Limited War you must prevent enemy aircraft and radars from reporting your presence. This means any who do see you should be destroyed if possible.

Aircraft visual sightings are especially dangerous. You should make every effort to shoot down an aircraft that gains a visual sighting.

Radar sightings are less dangerous, but a number of sightings is also very bad. Destroy radar sets that sight you where possible.

Also note that the ROE during Cold and Limited War will penalize you for hitting certain targets. Indiscriminate slaughter and destruction is not rewarded in these situations! See "Briefings, Rules of Engagement," (page 99) for more details

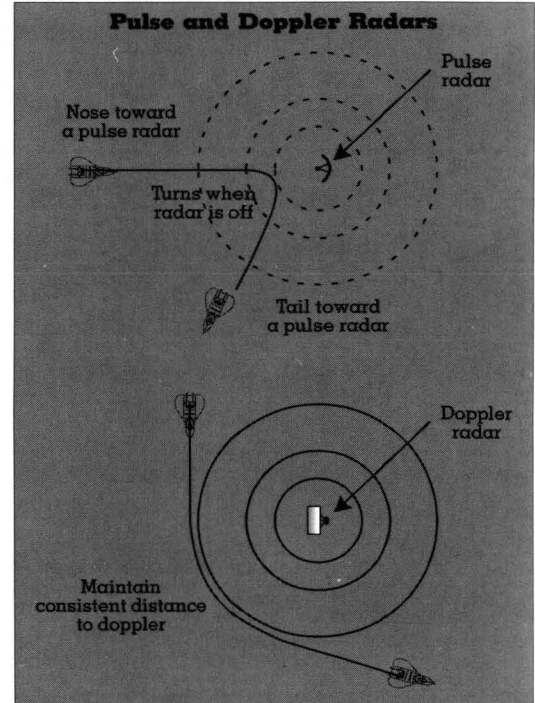

Rules of Engagement

Defending Against Attacks

Recognizing an Attack: Missiles cannot be fired until the enemy discovers your presence. As long as enemy search radars don't see you, you're safe from attack (with one exception, see below).

Enemy radar-guided missiles and longer-ranged IR (infrared) missiles "telegraph" their intentions by tracking you on radar first. This activity lights up the "TRAK" warning light in your cockpit. Once a missile is fired the "R" radar missile warning light, or "I" infrared missile warning light begins flashing. When a missile is within a few seconds of hitting your craft the missile alarm klaxon sounds.

Many short-range IR missiles don't use radar guidance. Therefore, these missiles do not activate the "TRAK" light. Instead they're launched from a visual sighting. They do not require any radar searches or tracking. If you fly near these launchers or over troop concentrations, you can be attacked at any time.

Disappearing: If you are attacked by radar-guided missiles (either the "TRAK" light is on, or the "R" missile warning is lighted), you can evade the attack by reducing your EMV or lower the enemy radar's effectiveness (or both). If the enemy radar loses sight of you the missile loses guidance and flies blindly ahead. It continues until either the enemy finds you again and steers the missile back on course, or the missile runs out of fuel.

Decoys: Your F-19 carries three (3) general-purpose decoys (launched with the *Decoy* key). Each one lasts 15 to 60 seconds after launch, depending on enemy quality. Launch a decoy to draw the enemy away from your course, or if you're under attack by so many missiles and planes you can't possibly evade them all.

Jammers: Use the ECM jammer against radar-guided missiles (missiles that light the "R" missile warning in your cockpit); use the IR jammer against IR guided missiles (those which light the "I" missile warning in your cockpit).

After you turn on the jammer, change to a different course and get away from the missile. If you don't, when you turn off the jammer (or an advanced missile gets close enough to "burn through" your jammer), it will start homing on you again. Advanced missiles that can "burn through" jamming include semi-active radar and second generation IR missiles.

Don't leave your jammers running. The ECM jammer increases your EMV, while the IR jammer reduces your speed. In addition, the IR jammer can overheat, causing it to automatically shut down until it cools off.

Chaff and Flares: A chaff or flare cartridge will decoy a missile for a few seconds. During that time the missile flies toward the chaff (if a radar homing missile) or the flare (if an IR homing missile).

Fire a flare cartridge (tap the *Flare* key) when an infrared missile ("I" missile warning is lighted) causes the klaxon to sound.

Fire a chaff cartridge (tap the *Chaff* key) when a radar missile ("R" missile warning is lighted) causes the klaxon to sound. Then immediately turn perpen-

pendicular to the missile's path, which is the safest way to evade a doppler-radar missile.

Maneuvering: Missiles only have a 45° forward "view". If you are outside of this arc, the missile cannot track you. Therefore, if you can lure the missile with a decoy, chaff or flare, or jam it, then fly outside of this arc, it will fly off. Some missiles, unfortunately, may circle around for another pass.

Missiles also have very wide turning circles. You can "turn inside" a missile, causing it to zoom past you.

A Note on Missile Warheads: Most missiles have proximity warheads: they explode when they pass within a certain distance of an aircraft. The warhead is in the center section of the missile. However, the rocket motor to the rear is often unaffected by the warhead, and continues running. Therefore a missile may appear to keep on going after it explodes.

Postflight Debriefing

Ending a Mission

Safe Landings: When you land, stop, and turn off your engines the mission is over. Once you land, you *cannot* refuel or rearm to continue the mission. All stealth missions are costly, carefully planned "one shot" operations. If a mission fails, higher-ups will decide later whether to try again, and if so, when, where and how. You may even get the same mission again some day!

Crashes: If you're using easy or realistic flight, crashing the aircraft ends the mission. It also ends your career. To remain alive, you must eject before the plane hits the ground. Of course, selecting "no crash" eliminates this problem. It also greatly reduces your possible score.

Bailing Out: Safe ejection occurs between 2,000 and 14,000' altitude with the plane in a gentle climb. Ejecting outside of these limits, especially from a plane under 2,000' altitude or in an inverted dive, can cripple or kill you.

Where you eject is important. Ejecting over water, away from an enemy coastline, is the ideal location. You can be rescued and the aircraft sinks out of sight. The next best location is over friendly territory. Again, you can be rescued, but fragments of the wreckage could be found by the public or enemy spies. Bailing out over enemy territory is the worst option. You will probably be captured, and fragments of the wreckage will certainly be found by the enemy, helping them learn the secrets of American stealth technology. Furthermore, if you are captured, you may suffer a public trial and other humiliations before the Air Force manages an exchange to get you back.

Ratings

After the mission you are debriefed. Your commander goes over the mission step by step, evaluating each event as it occurs and assigning a numerical score. Basically, if you accomplish the mission and follow the Rules of Engagement (ROE, see page 99), you'll do well. The more difficult the opposition, the more credit you'll get.

Objectives: Above all, accomplish the primary mission. It's hard to do badly if you achieve this. Failing that, at least accomplish the secondary objective. If you fail both of these, it is either difficult or impossible to gain any credit.

Cold War: Here it's important that nobody detect your presence. Visual sightings by enemy aircraft do the most damage. Enemy radars that positively track your plane are also bad. On the other hand, your commander gives you some credit for undetected flight through enemy territory.

Needless to say, random destruction is also a "no-no" in cold war. Naturally, destroying friendly planes and ground installations is the worst possible event. However, destruction of neutral or civilian targets is almost as bad. The least embarrassing events are destruction of enemy military targets, although even that should be avoided. In fact, the only time it is "permissible" to destroy

targets is if your mission orders require it, the enemy has sighted or tracked you, or if the enemy fired first.

Limited War: Here it's still important to avoid detection, although the penalties aren't as great. Flying undetected is worth a bit, but not much. On the other hand, your commander wholeheartedly approves of attacks on enemy forces, including military aircraft and obvious military installations. Civilian targets (such as passenger airliners, oil wells, refineries, bridges, etc.) will cause political problems and lower your rating.

Conventional War: Here your commander doesn't care if you're detected. Of course, you may still care, since when the enemy detects you they tend to launch all sorts of aircraft and missiles in your direction!

You will gain credit for destroying anything in enemy territory, even civilian targets (although military ones are worth more). In fact, your commander rather expects that you'll do a bit more than just hit the objectives. The only negatives possible come from the destruction of neutrals and friendlies.

Training: You get no credit for training missions. Training missions do not count toward promotions either (and therefore don't "drag down" your average either).

Combat Decorations: If your rating on a single mission is high, your commander will recommend you for a decoration. The five possible decorations, from easiest to most difficult to achieve, are:

- AM: Airman's Medal - recognizes heroic performance
- DFC: Distinguished Flying Cross - for superior performance in combat
- SS: Silver Star for Valor - for heroism in combat
- AFC: Air Force Cross - for extreme heroism
- CMOH: Congressional Medal of Honor - America's highest military decoration

You'll find that you must be outstandingly successful against the toughest opposition in the world to be nominated for the Congressional Medal of Honor.

Other Decorations: The *Purple Heart* is awarded to pilots who come home wounded. Surviving a mission with a badly damaged aircraft frequently yields this award.

The *Combat Readiness Medal* is awarded to pilots who successfully complete combat training by achieving the mission objective. Beyond this, the number of missions you survive determines what other ribbons you may receive: 5 missions for the *Overseas Ribbon - Short Tour*, 15 missions for the *Overseas Ribbon - Long Tour*, 30 missions for the *Longevity Service Ribbon*, and 60 missions for the *Longevity Service Ribbon with Gold Cluster*.

Promotions: Your starting rank is 2nd Lieutenant. Promotions are based both on your total score *and* on your average score per mission. Therefore, if you "goof up" and do badly in a mission, you may need extra high-scoring missions before you qualify for promotion. In addition, you can't get promoted

Decorations, Promotion & Reputation

without having sufficient experience (at least 2 missions for First Lieutenant, 5 missions for Captain, 10 for Major, etc). Ranks available, from lowest to highest, include:

2nd Lt:	Second Lieutenant (lowest)
1st Lt:	First Lieutenant
Capt:	Captain
Maj:	Major
Lt.Col:	Lieutenant Colonel
Col:	Colonel
B.Gen:	Brigadier General (highest)

Brigadier General is not a flying rank. You don't have a chance of earning that rank until you're retired from active duty. No pilot is expected to fly more than 99 missions. After that the Air Force decides: are you promoted to Brigadier General, are you simply given a Washington desk job, or do they suggest you leave the service and seek your fortune in civilian life? Very few pilots survive 99 missions with a record good enough to earn their "star".

Incidentally, don't feel badly about a middling rank. In active fighter squadrons most pilots are First Lieutenants and Captains. Majors serve as flight leaders, Lieutenant Colonels as higher squadron officers or commanders, and full Colonels as squadron or wing commanders. Promotion to Major or above is increasingly difficult. A Lieutenant Colonel or Colonel still flying active combat missions is an awesome thing in the USAF.

Reputation: In the Officer's Club ("O-club") bar, a flier's reputation is based primarily on how many missions he's flown. A 50-mission veteran has much greater prestige than a 1-mission greenhorn. Veterans of similar seniority may sometimes compare ratings, but nobody worries much about ranks or medals: as a fighter pilot, you're already a member of a very exclusive club.

Saving Your Record & Ending the Simulation

Pilot records are saved automatically. Every time the simulation exits the Pilot Roster screen (either to quit the game or to start a new mission) the records for all pilots on the roster are updated.

Note that dead (KIA - killed in action) and retired pilots cannot fly missions, but you can leave them on the roster to remind you of past glories (or failures).

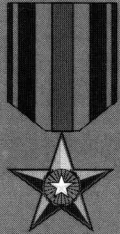

The Silver Star

This medal is awarded for gallantry in action against opposing armed forces. The large gold star design has a tiny silver star in the center, surrounded by a laurel-wreath design.

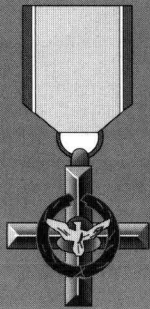

The Air Force Cross

This medal is awarded for extraordinary heroism in connection with military operations against an opposing armed force. It is the second highest combat decoration available to US Air Force pilots.



TECHNIQUES & TACTICS

3

This discussion of lift and flight is not rigorous or precise in a scientific sense. It only provides a rudimentary portrayal of the physics of flight and its practical effect on aircraft handling.

Aerodynamics and Flying

Lift: Aircraft fly because of a pressure difference as air flows over and under the wing. The wing design and airflow result in air moving faster over the top than over the bottom. This causes high pressure beneath the wing and low pressure above it. The wing is pushed upward, providing lift. If the pressure difference is great enough, the upward lift is greater than the plane's weight (i.e., the force of gravity) and the aircraft flies.

The Four Forces: Aircraft in flight have four basic forces acting on them. Thrust pushes the plane forward; it varies with engine power. Drag reduces the effect of thrust, but is relatively constant. Therefore, when horizontal, more thrust means faster forward velocity. Gravity pulls the plane toward the ground, regardless of the plane's attitude. Lift pushes upward from the wings, directly opposing gravity when the wings are level.

Basic Forces

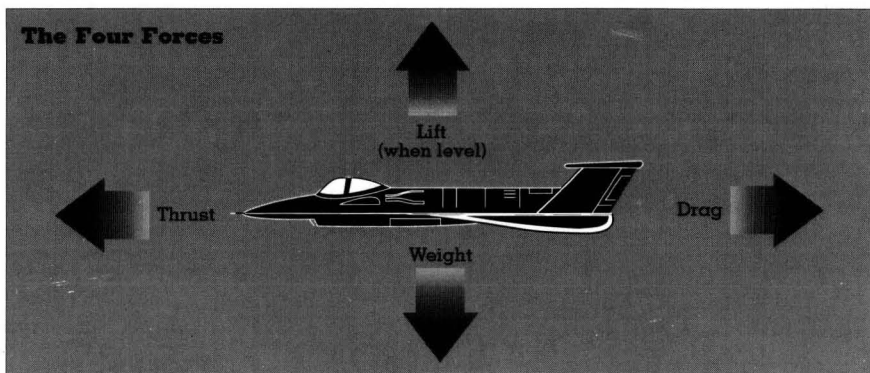
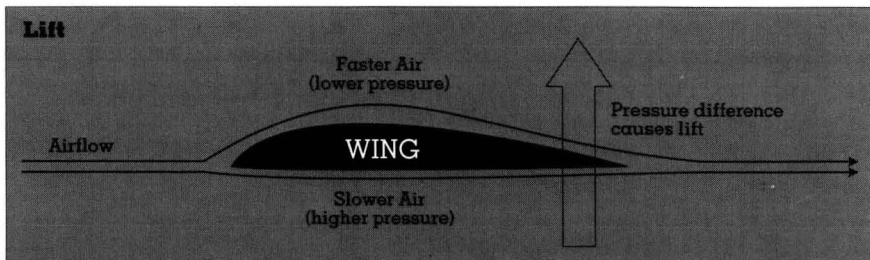

How Lift Varies

Speed & Lift: The amount of lift generated by the wing varies with airspeed. The faster the plane flies, the faster the air flows, so the greater the pressure difference. If your plane is in level flight at a certain speed, reducing the speed reduces lift, causing a descent (even though you didn't nose down).

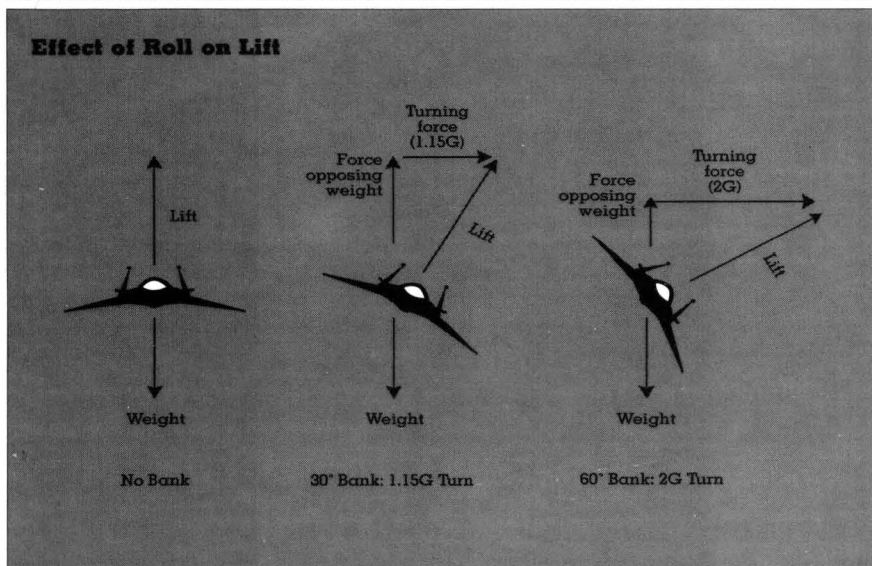
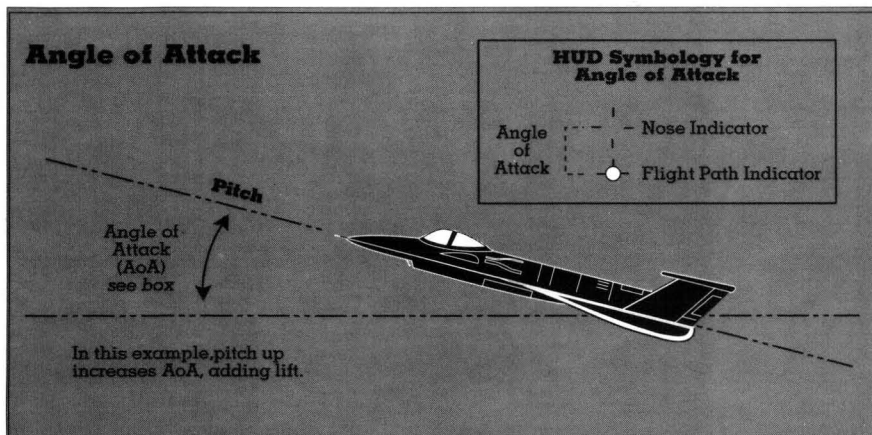

The Effect of Roll

Angle of Attack & Lift: The amount of lift generated also varies with the angle between the wings and the airflow. If you pitch up a few degrees, you increase the pressure difference across the wing, increasing the lift. If you pitch down the nose, the reverse occurs. This difference between the airflow direction and a line through the wing (the wing "chord") is the "angle of attack" (AoA).

Angle of attack is visible on your HUD in NAV and AIR-GROUND modes. In level flight, whenever your nose indicator is above your flight path, the difference between the two is the Angle of Attack.

Level Flight: To achieve "level" flight at a given power setting, a pilot raises or lowers the nose until the VVI shows zero (i.e., no ascent or descent appears on the "V" strip gauge). Note that a pitch of 0° may show ascent or descent. Nosing up or down to a new "angle of attack" adds or subtracts lift as needed to achieve level flight. *Never* assume that a pitch of zero automatically means level flight. Chances are good it doesn't!

To achieve "level" flight at a specific airspeed, the pilot first gets into level flight, next adjusts his throttle to achieve the desired speed, then adjusts his nose to find level flight for the new airspeed.

Lift is a force perpendicular to the wing. If the wings are tilted (your aircraft is rolling or banking) the lift force is no longer straight up. Instead it has two components, one moving the aircraft sideways, the other straight up. This causes the plane to turn. However, it also reduces the force opposing gravity.

As the bank increases, more and more force is needed to keep the plane flying level, since a smaller and smaller part of the force counter-

acts gravity. This force is measured in Gs, and is the reason pilots are pressed into their seats during a tight turn. Normal gravity and weight, standing on earth, is 1G. Pilots normally cannot survive more than 7 to 9 Gs; any more and they black out, losing control and crashing.

During a turn a pilot can adjust the angle of attack by control stick "backpressure", that is, by pulling back slightly on the stick. The amount of adjustment is very small. Overcorrecting is a common error among beginner pilots.

Stalls: An aerodynamic stall occurs when the wing's angle of attack becomes too large. The air stops flowing smoothly over the wing, and instead part breaks away onto an independent path. This erases the pressure difference, vastly reduces lift, and generally causes the nose to drop. Stall speed varies considerably depending on aircraft attitude, flaps configuration, etc. Tight turns increase the stall speed. Note that simultaneously the act of turning tends to decrease your airspeed. As a result, stalls are quite common in tight turns.

Some versions of the F-19 have an audible stall warning horn. All versions have a colored bar showing stall speed on the HUD's airspeed indicator.

The F-19 includes a computerized stall recovery governor that instantly reconfigures the wing edges for automatic recovery, making your job much easier. To recover from a stall, first level the wings, then bring the pitch back to normal. A stall invariably costs you altitude, so a stall at low altitude can be fatal!

Flaps: Lowering flaps extends the wing surface and increases the pressure difference, adding more lift. They also increase drag, which lowers your speed. However, flaps are only useable at low speeds (under 300 knots).

The "straight-in" landing technique described on page 00 is used by pilots who are wounded or are flying damaged aircraft. Military pilots normally use a 360° Overhead Pattern for maximum speed and efficiency in the landing pattern. Pilots who fancy themselves "real Air Force men" should use real military landings, not simple straight-in landings.

A military land pattern has 7 parts: Initial, Pitch Out, Inside Downwind, Perch, Final Turn, Final, and Touch Down.

The "Initial": Start your "initial" landing leg at 400 knots, a slight pitch up (usually just 1°), at 1,500 to 2,000' altitude. Adjust your throttle to this speed, then nose up (for a greater angle of attack) to maintain level flight. Approach the runway/aircraft carrier in the direction you wish to land, with the runway/ carrier sliding beneath you.

Pitch Out: Shortly after the runway disappears beneath you, begin the "pitch out" turn by banking gradually to a 45 to 60° roll (a left bank is preferred by many pilots). This will be a full 180° turn. Your speed should drop to about 300 knots while in the turn. You may need to raise or lower your nose in the turn to maintain your altitude.

Inside Downwind: When you finish the turn and level out, you're on the

Special Situations

Military Landings

Military 360° Overhead Pattern

Pitch Out:
180° turn at 45-60° roll
Maintain 1,500'-2,000'
Speed falls to 300 kts

Inside Downwind:
Level flight or slight descent,
300 kts speed,
Landing gear down

Perch:
Lower flaps
Begin turn and descent

Final Turn:
180° turn at 15-30° roll
Speed falls to 200-230 kts
Descend to 300' (runway)
or to 100' (carrier)

Initial:
Level flight
1,500'-2,000' altitude
400 knots

Bow Catapults

"Island"
Superstructure

Arrestor
Cables

Final &
Touchdown

"inside downwind" leg of the landing. Immediately reduce the throttle and nose up a bit more to maintain level flight at 300 kts, then lower your landing gear.

Perch: Look to the side at the runway. When you are even with the end of the runway or carrier deck, you've finished the inside downwind and are at "the perch", ready to start the final turn. Don't be surprised if the first time you look, you're already at the perch — it comes up fast!

At this point you lower your flaps. Now pitch the nose down until your VVI indicates a descent. As you drop the nose begin your final turn.

Final Turn: This is a slow 180° descending turn. You will descend to about 300' (for a runway) or 100' (for an aircraft carrier) at 200 to 230 knot airspeed. Your roll should be 15° to 30° in the turn. Notice that the altitude gauge on the HUD gains speed and detail once you pass the 1,000' (1K) mark. Make sure you don't start out with too fast a descent.

Change your nose pitch (up or down) to control the rate of descent in this final turn. You should finish the turn with the runway or carrier deck dead ahead.

Final: When you finish the final turn lined up with the runway/carrier, pull the nose up to gain level flight, then back off a tiny bit for a very gentle descent. Change pitch to adjust your descent, and your throttle to adjust your speed. However, regulating your descent rate with pitch changes takes practice. You regulate with pitch (not throttle) because if you're too fast you can always cut the throttle or use the speed brake at the last minute, or at least come around again for another try. But if you get the throttle setting too low you may stall and crash.

Touch Down on Runways: When the wheels touch down on the runway, cut the throttle, lower the nose wheel to level, and apply the brakes. When you stop moving the

mission is over. As in all other landings, the downward vertical velocity should be less than 400'/minute at touch down

A gradual touchdown, as described on page 55, is the safest and easiest method. However, "real" pilots reduce the throttle and pull on the stick slightly to "flare" on touch down. This scrubs extra speed and softens the landing. Of course, this can be tricky — novices sometimes "porpoise" or "bunny hop" down the runway because of too much stick movement, or worse yet, go too far and stall the plane.

Touchdown on Aircraft Carriers: When the wheels touch down on the stern of the carrier, you should snag an arrestor cable and stop immediately. Cut the throttle and apply the brakes to end the mission. You can touch down on a carrier at greater vertical velocity than on a runway.

Radar & Stealth

Radar

F-19 Radar Reflections

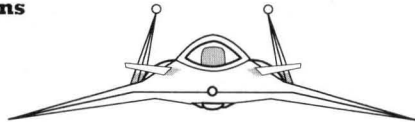

Cockpit, canards and stabilizer roots are the only significant radar reflectors

●
Front or Rear
Radar Return

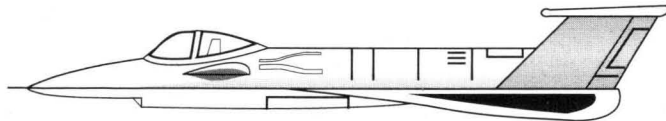

Canards and stabilizers show more surface area to side, increase radar reflection

●
Side
Radar Return

Radar sends high frequency electro-magnetic waves through the atmosphere at virtually light speed. These waves bounce off solid objects. Some bounce back toward the radar set, which includes a signal receiver. By measuring the strength of the returning signal, angles of returning waves, time it took to return, etc., radars estimate the range, position, and size of an object.

Radar waves bounce best from solid, dense, flat, perpendicular surfaces. Traditional aircraft shapes, especially aircraft engine intakes, slab-sided fuselages, and vertical tail fins make excellent radar reflectors.

The radar reflections of an object are greatly reduced if its shape minimizes the returning waves. This does not make the object invisible, but does make it very hard to "see". For example, if a normal airplane is visible to a radar at 200 kilometers away, a carefully shaped airplane

Stealth Technology

might be invisible beyond 50 kilometers! Creating this shape in a form that is also aerodynamic requires extremely complex computer modeling. As the world's leader in computer applications, it's inevitable that America would be first in this field. The SR-71 spy plane is an early example of such shapes in aerodynamics; the redesign of the B-1 bomber fuselage is another example.

In addition to shape, certain rubber and ceramic compounds tend to "absorb" radar waves, making the return signal weaker than normal. Known generically as RAM (Radar Absorbent Material), it can be incorporated in paints, or planted in "wedges" along the surface of a wing or fuselage.

Finally, an airplane's heat signature is an important consideration. Many airplane-killing missiles home on heat sources. The newer longer-wavelength sensors see warm parts of the craft (such as leading edges of the wings, tail, and air intakes) heated by air friction. The main defense against heat-seekers is to incorporate heat-resistant materials onto edges that "cut" through the air, and to mask and disperse the hot engine exhaust as much as possible

"Stealth" is the combination of superior shapes and RAM materials that vastly minimizes the radar and infrared visibility of an aircraft. The F-19 design sacrifices speed, maneuverability, and payload for maximum stealth. The air intakes to the twin turbofan engines are masked. The fuselage is molded into the wing shape to eliminate hard angles, as well as letting the

fuselage itself act as a "lifting body". The tail is twinned and tilted inward to reduce reflections. Upper and lower hull and wing surfaces are covered with RAM inserts. All weapons are carried internally, since external pylons and armaments are excellent radar reflectors. All leading edges incorporate heat-resistant surfaces. The jet exhaust is directed through slats that absorb heat and mix in cooler air to break up the rearward heat signature.

Stealth also demands a new approach to combat operations. For decades jet aircraft have carried radars of increasing power, using them to aim weapons, check altitude, and to fly low at high speeds. All this radar broadcasting often reveals a plane long before enemy radars discover it. A stealth aircraft must fly without active radar emissions. The F-19 uses visual, thermal and laser systems instead of radars. In addition, it has a radio burst decoder that is designed compatible with other USAF transmission equipment. On an active mission the F-19 constantly receives data bursts from friendly AWACS planes and ground radars.

Overall, the F-19 is most difficult to detect at very low altitudes. Even at higher altitudes (over 1,000') it is far less visible on radar than a normal aircraft. This not only allows the F-19 to "sneak up" on the enemy, it also reduces the range and accuracy of enemy weapons.

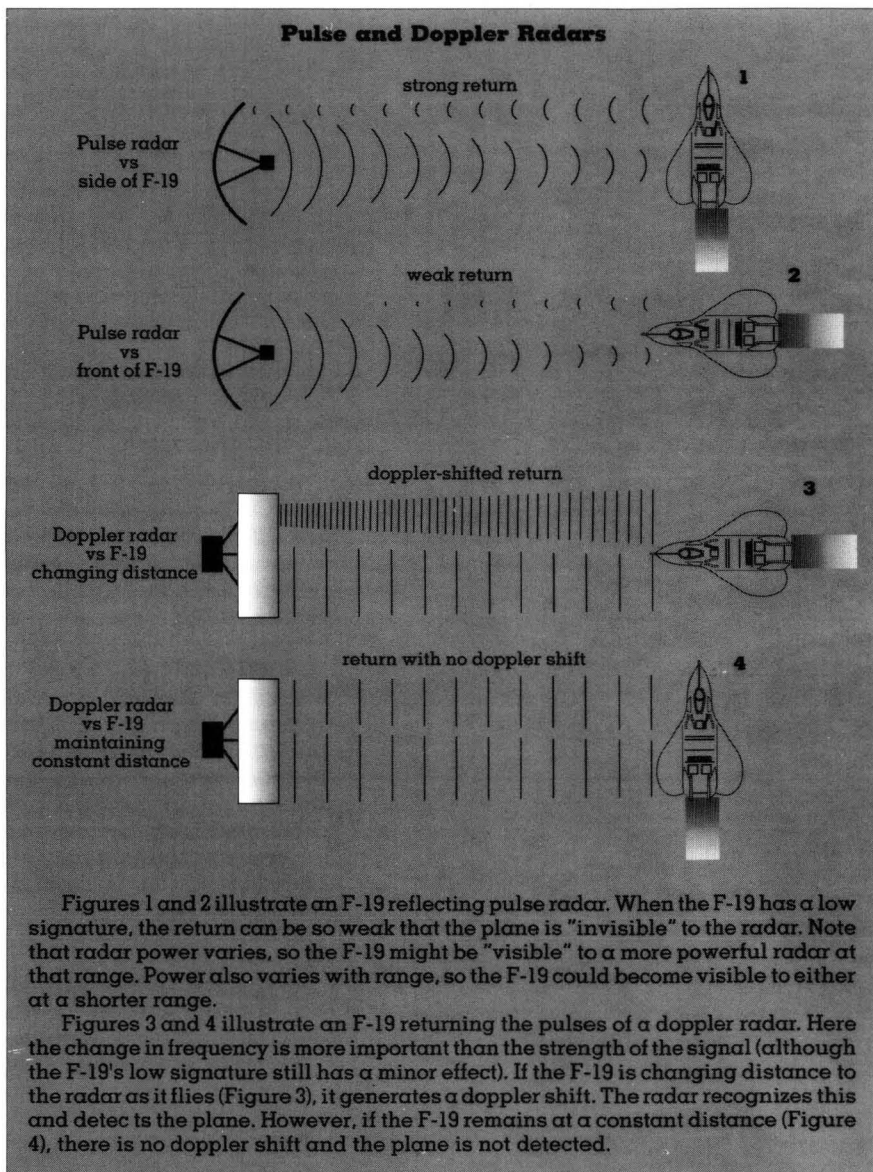

Stealth Tactics

Planning: As a stealth pilot, you must plan your mission. You're seeking the best way to slip past the enemy radar defenses, a route in and out that either makes you invisible, or makes you visible for the shortest periods of time.

Even the best of plans must be modified once the mission starts. Enemy fighter patrols and Mainstays can force you to change your plan, while the periodic shut-downs of enemy radars can suddenly open new opportunities. You must keep your plans flexible.

EMV: The F-19's stealth configuration is most effective when flying at very low altitudes (at 500' or less, and preferably about 200'). The EMV is further reduced if the engines are throttled back to cruise speed (70% power). Level flight, which presents a horizontal profile, is best. The steeper the turn, the more topside or underside surface is presented as a radar reflector, and thus the higher your EMV.

Your flight path is a crucial consideration with enemy doppler radars. Changing distance to a doppler radar increases their detection abilities manyfold. If you remain at a constant distance, arcing around the radar, their detection ability drops precipitously.

On the negative side, opening the weapons bay, firing a weapon, or using the ECM jammer all raise your EMV, making the plane more visible. On the plus side, if you want to deliberately lure the enemy to a certain location without wasting a decoy, then turning on your jammer, opening the bay, and spiralling upward in a tight turn often raises the EMV enough to make you visible. You can then close up, dive down to 200' again, and zoom away while they chase phantoms.

Low Altitude Tactics: On long missions with flight legs outside effective enemy radar range it's perfectly safe to use the autopilot and cruise at 500'. When within enemy radar maximum range, get down as low as you can. Flying through valleys between hills and mountains is always better than flying over them. Although coming up over ridgelines is fun flying, every time you crest a ridge you're a sitting duck for enemy radar. Under 500' be prepared for a rough ride due to air temperature changes near the ground.

One especially sneaky tactic is to fly extremely low (200' or less) and throttle back your engine to about 30% power. You'll need to extend flaps and pitch up (for a high angle of attack) to stay airborne, but your EMV is now extremely low. F-19s have skimmed underneath patrolling MiG-29s and MiG-31s using this tactic.

Threading the Needle: Penetrating through enemy radar umbrellas is a tricky job. Remember that you should arc around doppler radars, but fly directly toward (or away from) pulse radars. The plotting of paths through radar areas is sometimes termed "threading the needle".

Typically the pulse radars are shorter ranged and less efficient, making the dopplers your biggest problem. If you must fly into a pulse radar's effective range, you can arc around just inside and hope that your EMV is low enough,

and their crews sleepy enough that they don't see you.

Beware of enemy fighter and AEW&C patrols when "threading the needle". Your ideal course can turn into a death trap if enemy fighters are waiting for you, or you fly strait toward toward an Il-76 "Mainstay".

Decoys: In Cold War or Limited War you must avoid leaving a positive radar ID. If your flight path takes you too close to enemy radars, you can try leaving one or two decoys behind you. This can prevent them from getting a positive radar ID on you.

Dash: Many radars turn off periodically. If you see a critical doppler radar station stop broadcasting, that may give you just the edge you need to get past them without being seen. Dashing through a radar's area while he's off the air is always risky: you never know if he'll "wake up" and find you. Alas, sometimes there's no better way.

Blast: If you can't think of any better way to get through the enemy radar screen, a final device is to use a Maverick or HARM missile to destroy the radar, opening a gap. Of course, you've got to dash through the gap and get away quickly, since enemy aircraft are drawn like flies to the site of any attack. Other radar stations also tend to "wake up" and stay on the air more after an attack. One way to "set up" a blast attack is show yourself briefly in one location, drawing enemy fighters away from the area you plan to fly through and/or attack.

Threading the Needle

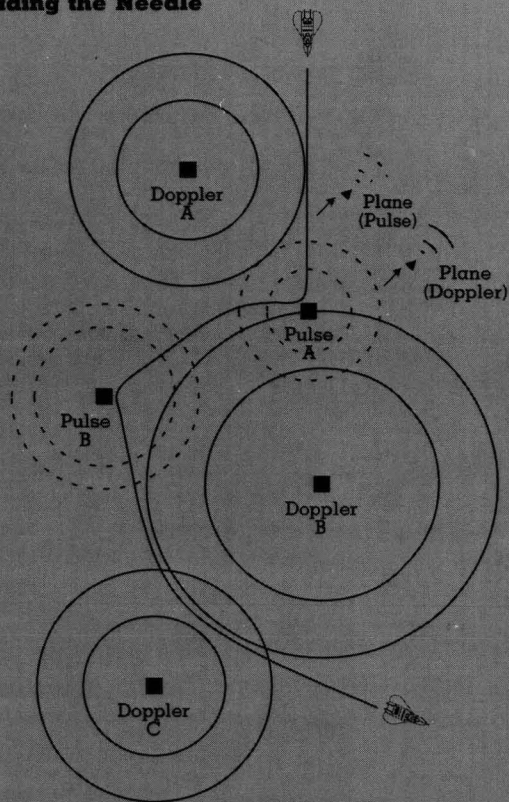

The F-19 selects a route past the edge of Doppler A's effective range, slipping in behind the two patrol planes while their forward-only radars are facing the wrong direction. It charges Pulse A, turning away when Pulse A is off. It then skims around Doppler B, charges Pulse B (as it did A) and turns away when B is off. There is no "safe" route available between Dopplers B and C. The pilot could fly between them, but instead selects to skim around B and fly into C somewhat. Since C has the smaller effective range, it is weaker, and therefore (the pilot reasons) less likely to see the plane. Of course, the pilot could get lucky and find that Doppler B or C shut down for a period, allowing him to pass through the temporary gap.

Air-to-Ground Tactics

Ground Attack

Target Selection

Regardless of the weapon system you're using, attacks are much easier if your tracking camera is following the target. Remember that the color and size of the target box on your HUD graphically illustrates the effectiveness of your current ordnance. A totally ineffective weapon shows a special color target box (see the Technical Supplement). If a weapon is effective, the larger the box, the greater its effectiveness.

The *Select Target* key cycles among all pre-programmed targets in the near vicinity ahead of you. Pre-programmed targets include your primary and secondary targets, SAM sites, warships, and airbases.

If you wish to select some other target, you must use the *Designate New Target* key function. This locks the tracking camera onto the nearest available target directly ahead. The new target joins the pre-programmed list (in the *Select Target* cycle) until you either destroy it or designate something else instead. A nearly infinite variety of ground targets can be designated, from troop concentrations to major bridges.

Strafing with Cannon

See "How to Fight, The 20mm Cannon," page 57 for specific instructions on how to operate the cannon.

Using your M61A1 20mm Vulcan cannon against ground targets requires some skill. In a strafing attack you fly low (under 500') and level. Because the cannon gunsight is optimized for air-air combat, "walking" your shells across the ground is the best way to hit a target. Unfortunately this uses a lot of ammunition. Experienced pilots confine themselves ranging bursts until they're close, then use continuous "walking" fire at the very end, just before they pull away.

The most difficult problem in strafing runs is your limited range. Maximum cannon range is only 6 kilometers, and effective range really 3 kilometers. This means you have just a couple of seconds to hit the target before it passes beneath your gun.

A common error when strafing is "target fixation" where you ignore altitude. Remember that strafing means diving— and you've got to come up again sometime!

After you pass your target, close the air brakes, open the throttle and turn away. Keep an eye on your missile warnings and be ready to drop chaff or flares.

Air-to-Ground Missile Launch

See Aircraft Controls, Weaponry, page 43-45 for specific instructions on how to use air-to-ground missiles.

The Maverick (AGM-65D) and HARM (AGM-88A) missiles are both "fire and forget" weapons. Once your tracking camera is on the right target, it's just a

matter of waiting for the tracking box to change from square to oval (indicating a lock-on), and then the oval to change color (indicating a high-accuracy firing solution). Air-to-ground missiles are valuable, so it's generally wise to wait for the highest accuracy shot possible.

When launched the missile starts with your course and velocity, but will fall through the air about 300' before its motor fully ignites and accelerates the weapon. Therefore, unless you're climbing, it's unwise to fire below 500', and very unwise to fire in a power dive (as the missile may slam into the ground before it can fly away). It is also extremely unwise to fire while in a tight turn or inverted, as the missile may tumble when leaving the bay, losing guidance or even smashing into your plane.

The maximum range of a missile depends both on the amount of fuel it has and its launching speed. The faster you're flying, the greater the missile range. The tracking box turns oval when you are in absolute maximum range. Therefore, if you're flying slowly it's wise to wait a bit before launching.

Once the missile is launched you can change to new targets, new weapons, and maneuver as you wish.

See "How to Fight", page 58 for specific instructions on operating PAVE TACK laser-guided bombs, including toss bombing.

Range: Glide bombs can fly about 2 kilometers distance for every 1,000' of altitude you have.

Toss Bombing: This tactic (described on page 58) is the best method, since you can approach the target low (about 500'), and only pitch up briefly during the release, after which you roll over and turn away as the bomb hits the target.

Level Bombing: You can level bomb with glide bomb weapons. As a general rule you'll need to attack from at least 2,000' altitude. Here you can lock onto the target at 4 km range. Attack immediately and turn away. Remember, though, to keep your underside facing the target. You can fly over the target instead of flying past at an angle, but you must rise above 3,000' to do this safely.

Needless to say, these high altitudes make you a sitting duck for enemy radars and SAMs.

See "How to Fight", page 59 for specific instructions on launching retarded bombs.

Altitude: Retarded bombs are the easiest and safest weapons to use, and one of the most popular among USAF pilots. If you keep up speed in your bombing run, you can safely release from just above 500' altitude, even though the burst area is 3,000'. This is because retarded bombs lose speed very quickly,

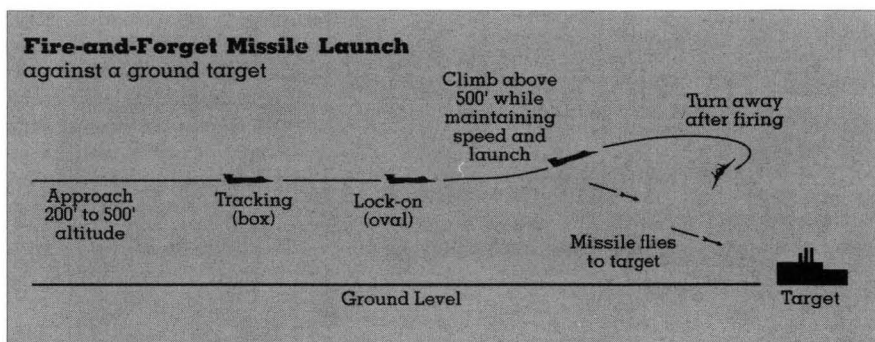

PAVE TACK: Laser Glide Bombing

Retarded Bombs

causing them to rapidly fall behind your aircraft.

Accuracy: Retarded bombs are also less accurate than free-fall or laser-guided bombs. Therefore it's unwise to attack from a high altitude, since they will probably miss. It's also very difficult to hit pin-point targets with retarded bombs, although cluster bombs (like the Rockeye or the Mk 35) give good area coverage, compensating to some degree for drop inaccuracies.

Dive bombing and toss bombing don't produce useful results with retarded bombs. You must use level bombing.

Free-Fall Bombs

See "How to Fight", pages 59-60 for specific instructions on dropping free-fall bombs in level flight. Although easily perfected, this technique requires you to fly a long, straight course at high altitude (3,000') — a rather dangerous practice! Dive bombing is a more accurate technique, but requires considerable practice and skill.

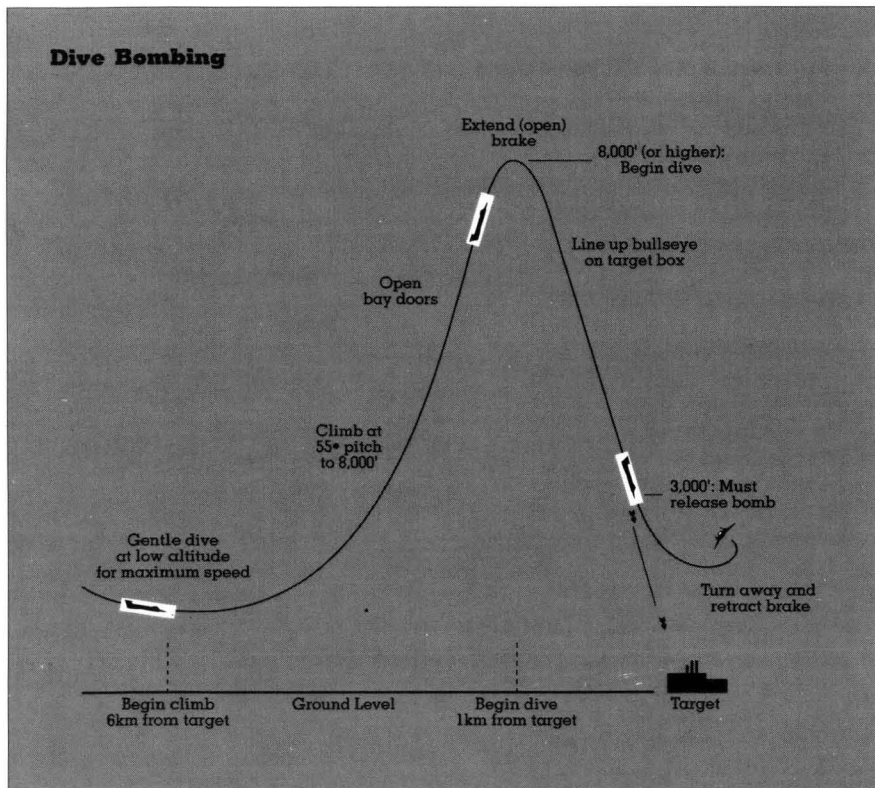

Dive Bombing Technique: To make a dive-bombing attack, start by flying low toward the target. Switch your HUD to Air-Ground mode, make sure the correct ordnance is selected (Mk 82-0 Slick or Mk 122 Fireye), and put your tracking camera onto the target. Now follow these three steps:

(1) *Guide on the Bombsight Flight Path:* Approach the target by flying straight at the diamond-shaped bombing flight path indicator. It's okay if the indicator is above or below your flight path, but make sure it's not to the left or right.

(2) *Climb to Attack Point:* As you get to 6 km from the target, zoom up into a 55° climb to reach an altitude of 8K (8,000') opening your bay doors as you climb. Your objective is to reach the 8,000' point about 1.5 to 2 km away from the target.

(3) *Dive onto the Target:* Level out, flick open the brakes (tap the *Brakes* key), and at just under 1 km away push down into a steep (80°) dive. As you plummet earthward, line up the bomb bullseye (the circle on the end of the fall-line) onto the target box center. Keep an eye on your altitude. If you drop below 3K' (3,000'), pull out and try again — you must drop before reaching 3K' altitude.

(4) *Release Bomb and Turn Away:* If you manage to keep the bullseye steady within the

target box before reaching 3K' altitude, release a bomb immediately. Then continue the dive and alignment, releasing another just before you reach 3,000', assuming you can keep the plane aligned on the target box. After the release pull up sharply and roll away in a 90° turn. Close the brake as you do this, to maintain maximum speed into the turn. Then close the weapon bay doors.

Notes: The zoom climb to 8K is the most critical phase of the attack. If performed flawlessly, a 55° climb will cover 4 km of ground, assuming you start at maximum level speed with 200' altitude and wish to arrive at 8,000'. Some pilots prefer to use a slightly shallower zoom climb up to 10,000', but this exposes you longer, at higher altitudes, to enemy fire.

Climbing to a dive bombing position usually broadcasts your presence to the opposition. Therefore, once you're turning away from the target after the bombing run, look over and check the R and I missile warning lights for an attack.

The most common mistake when dive bombing is forgetting to open the brakes at the top of the climb (i.e., just before you dive). With the brakes closed you plummet so fast it's almost impossible to line up the target and release the bomb before reaching 3K' altitude.

See "How to Fight", page 60 for specific instructions on how to operate the 135mm/IR camera. Always remember to use Air-Ground mode and lock the tracking camera onto the target at the start of the run. After you open the bay doors you'll fly to align the Camera Lens Sight in the target box, snapping the pictures as you do so.

Camera runs are similar to strafing runs, but somewhat easier because the downward cant of the camera means you can fly a level run, rather than dive and pull-out. Some camera experts prefer to fly in a gradually increasing climb to hold it on target.

The greatest difficulty in camera runs is clicking the picture at just the right instant. Flying with air brakes extended slows your speed, making it easier to line up your shots.

Remember: A successful photographic mission requires a safe landing to deliver the film.

Cameras

To avoid enemy SAMs you must understand them. Then you can intelligently apply the appropriate defense.

Concept: Medium- and long-ranged SAMs are controlled by radar. All types use the same three-step process to engage you, their target:

(1) *Radar search:* Their search radar scans the sky for alien planes, such as yours. Although human eyesight can aid in the search, its range is much less,

SAMs (Surface-to-Air Missile Systems)

Radar-Controlled SAMs

Radar-guided SAMs (Surface-to-Air Missiles)

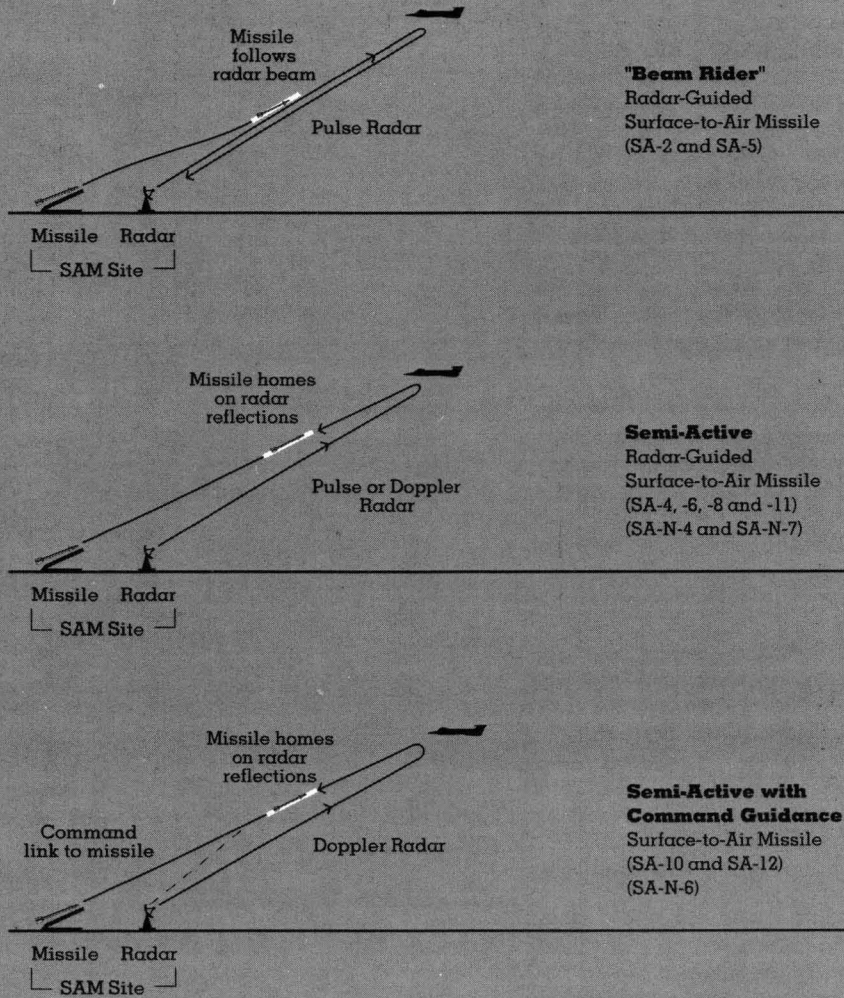

especially in bad weather. Search radars scan an entire 360° area periodically.

(2) *Radar tracking:* When a search radar finds your plane, it "hands off" the prospective target to a narrow-beam fire control radar, usually running on a different frequency. This narrow beam finds and locks onto your craft. When the fire control operators are sure their beam is tracking correctly they launch a missile.

(3) *Radar control:* Once the missile is launched, the ground radar continues tracking your plane so the missile's course can be updated and corrected. There are two common methods of doing this, the older "beam rider" (or "command guidance") technique, and the newer "semi-active homing" technique.

Beam Rider SAMs: Using this system, the tracking radar simply continues tracking you, its target, while the SAM guides along that radar beam toward you. As long as the tracking beam remains on your plane, the SAM will hit.

ECM jammers are an excellent all-purpose defense against beam riding missiles. Since your radar reflections must travel all the way back to the ground radar, the jammer remains effective even if the missile is very close.

Beam-riders are also the least maneuverable of missiles. If the radar beam moves too fast the missile can't correct fast enough and "loses" guidance.

Semi-Active SAMs: This type of missile has a radar receiver and computer in its nose. The tracking radar on the ground "paints" your aircraft with a radar signal and the missile's nose receiver "catches" the reflections. The missile homes on these reflections until it hits you.

ECM jammers are useful only at long range against these semi-active SAMs. At close range the "painting" reflections to the missile are very strong — strong enough to "burn

through" your jamming. As a result, the missile finds you again, assuming you've remained in its 45° field of view.

Command Guidance SAMs: These modern missiles use semi-active guidance (see above). In addition, the firer has a command link to the missile, which he can use to override the semi-active guidance. This means that if the missile loses guidance or is otherwise confused, the ground controller can turn the missile around and try again.

Reduce EMV: The basic way to evade radar-guided SAMs is to disappear from their radar. If their signals are just barely overlapping your EMV, you should find a way to simply "disappear."

First and foremost, the further you are from the enemy radar, the weaker their signal. Therefore you may wish to simply turn and run away from a while, until their signal is too weak to "see" you. If the enemy is a doppler radar, at various points you should turn parallel to the radar. When you do, his signal weakens.

Also remember that reducing your altitude, lowering your engine power, and levelling out your flight all help. Make sure the weapon bay doors are closed, the landing gear up, and the ECM jammer is off.

Decoys: A decoy will fool enemy radars for 15 to 60 seconds, depending on the skill of the enemy. During this time missiles, like everyone else, will pursue the decoy instead of you. This gives you a perfect opportunity to outmaneuver the missile by escaping its 45° field of view.

ECM: Your ECM (electronic counter-measures) radar jammer is an excellent defense against beam-riders. As long as it's running they are flying blind, and therefore unable to hit you. However, ECM is effective against semi-active SAMs only at long range. Remember that if you continue flying toward a jammed semi-active missile, eventually it will "burn through" and start homing on you.

ECM jamming makes a lot of noise. Therefore, don't use a jammer against semi-active SAMs unless you're going to turn away.

Chaff: Each chaff cartridge deploys a cloud of tiny tin-foil strips that reflect enemy radar. For two or more seconds the strips form a huge radar reflector, effectively blinding it, like a smoke screen.

Therefore, the classic chaff technique is to wait until a radar-guided missile is just a couple seconds away (i.e., when the missile proximity klaxon sounds). At that instant fire a chaff cartridge (tap the *Chaff* key) and turn away. The blinded missile will fly straight into the chaff, missing you.

Warning: Chaff may not fool a doppler-guided missile (SA-10, SA-12, SA-N-6, or AA-10). In this case, you must turn perpendicular to the missile.

Maneuvering: It's important to remember that defense devices aren't perfect. Some missiles can "burn through" your ECM. All missiles continue seeking after your decoy or chaff expires. Doppler missiles will ignore chaff if you're on the wrong course.

Evading Radar Guided SAMs

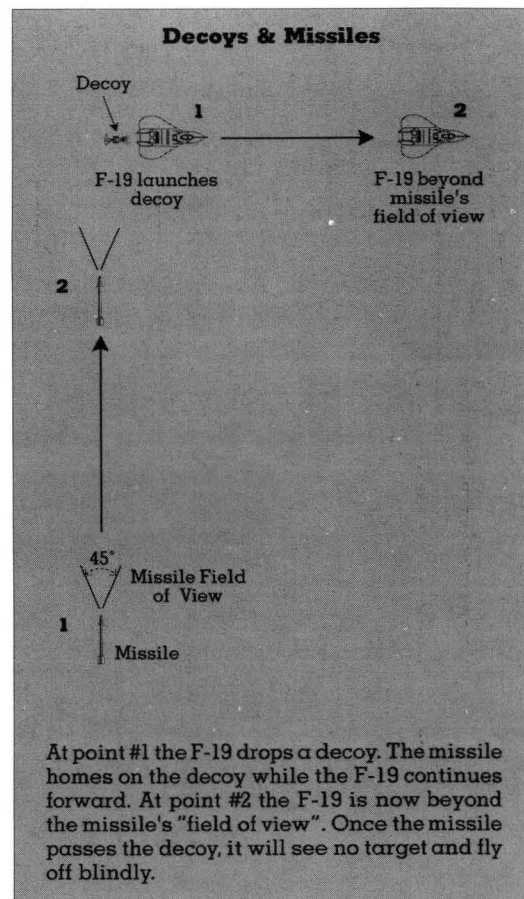

Therefore, it's important to maneuver out of the missile's field of view when the defense expires. If you don't, the missile will re-acquire you and continue on a collision course!

If you're an especially skillful pilot, you can try out—maneuvering an enemy missile without mechanical aids.

In any case, see "Outmaneuvering a Missile", below. Smart pilots normally use both their equipment and their maneuvering skills.

Warnings & Responses: Your first warning of a radar SAM attack is when enemy search radar finds you. Your second warning is when they switch over and begin tracking. This sets off your cockpit TRAK light. During these stages reducing the EMV is your best defense.

Your third and most important warning is when the missile warning light (in this case the "R" light) comes on. This means a missile is in the air, flying toward you. Reducing your EMV may derail the enemy attack, but if you're too close to their radar you must use other defenses.

Against a beam-rider you can turn on the ECM, change course a bit, and laugh as it flies blindly past.

Against a semi-active missile you can either jam with ECM or drop a decoy, then change course. Some people use both — decoy first, then the jammer for insurance. However, this technique only makes sense if you can escape the missile's 45° field of view before the decoy and/or ECM effects end.

Your final warning is the missile proximity klaxon. It sounds when the missile is just a couple of seconds away. Check the cockpit — if the "R" light is burning then a radar missile is inbound. *Immediately* drop a chaff cartridge and turn away.

IR (Infrared) Homing SAMs

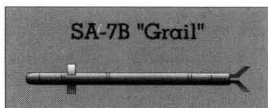

Concept: Short-range SAMs are usually IR (infrared) homing. The largest and most powerful use a three-step process like radar-guided missiles:

(1) *Radar search:* A search radar finds your aircraft (watch the EMV scale for this).

(2) *Radar tracking:* A tracking radar follows your aircraft (the "TRAK" light comes on in the cockpit).

(3) *Missile launch:* The IR homing missile is launched (the "I" missile warning light comes on in the cockpit). At this point tracking radar is unnecessary, as the missile can guide itself to target.

However, many shorter-ranged IR SAMs use a much simpler technique:

(1) *Search:* The enemy, searching the sky, detects your plane. Some systems use a search radar, others get search information from other radar stations over the radio, and some rely on simple eyesight.

(2) *Missile lock-on:* The missile is aimed at your plane. If you're close enough and "hot" enough, the missile will see your heat signature and lock on.

(3) *Missile launch:* Once locked on, the missile launches and guides itself toward you.

Shoulder-Launched IR SAMs: The existence of man-portable IR SAMs

makes your life difficult. The enemy frequently waits until point-blank range to launch these missiles, the preferred technique being to launch them during your attack run.

Carried by infantrymen, in trucks and jeeps, or stacked inside a building door, they are virtually undetectable until fired. Wherever significant enemy military forces are deployed you can expect these weapons. This includes rear area headquarters and depots as well as frontline troops.

First Generation IR Homers: Early IR homing systems required a large heat signature as a target. On a jet airplane, the only area hot enough was the engine exhaust. As a result, the missile wouldn't "lock on" until aimed at the rear of the plane. Furthermore, the homing head wasn't especially sophisticated or sensitive. Just about anything would confuse it (including the sun or hot rocks on the ground!)

Your IR jammer is almost guaranteed to confuse a first generation IR homer. As long as you leave the jammer on, the missile will be unable to follow your plane. Remember, though, that the jammer slows you down, and will eventually overheat, causing it to shut off automatically.

You can also outmaneuver first generation IR missiles by turning tightly toward them. This "rotates" your hot exhaust away from the missile's view. The missile may try to turn and follow your exhaust, but a tight enough turn always outmaneuvers it (see "Outmaneuvering a Missile", below).

Second Generation IR Homers: Modern IR homing systems are far more sophisticated and sensitive. They are tuned to fine changes in temperature, and only "recognize" temperature variations typical of aircraft. This includes not only the hot exhaust, but all surfaces heated by air friction. This heating typically occurs at the nose, wing roots, and across the upper surfaces of the plane. Therefore the front and top of a plane appear "hot", while the underside is relatively "cool". The missile can lock onto your plane whenever it "sees" a hot surface.

IR jammers are only effective at long ranges against second generation IR homing missiles.

Reduce EMV: As with radar-guided SAMs, if you reduce your EMV and disappear from search radars, the enemy is unable to launch new missiles at you. Unfortunately, it has no effect against missiles already in the air.

Infrared Signature of the F-19

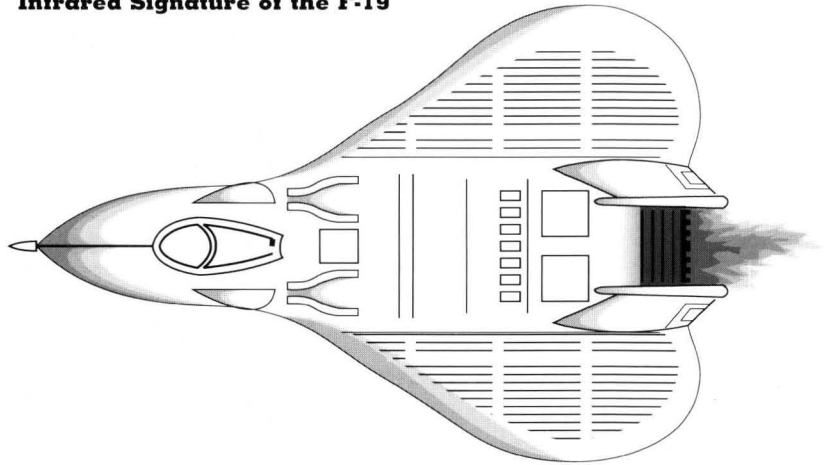

The shaded areas on the nose, leading edges of the wings and tails, air intakes, and engine exhaust represent the hottest regions of the aircraft.

Evading IR SAMs

EMV reduction methods are the same as above (see "Evading Radar Guided SAMs").

Decoys: A decoy will fool enemy IR missiles (like everyone else) for 15 to 60 seconds. Tactics are therefore just like decoys against radar missiles — outmaneuver the missile by getting outside its view before the decoy expires.

IR Jammers: This device is a heat strobe. It sends out pulses of heat that confuse a missile's warhead. The disadvantage of this equipment is that it must deploy a generator to provide sufficient power, slowing your airspeed by roughly 15%. In addition, the strobe can overheat if left running too long. When it overheats an automatic shut-off occurs (before it melts down!). If you try to turn it on again shortly after shut-off, the strobe is still hot. It will only run for a short time before shutting off again!

First generation IR missiles are easily confused. The jammer is effective at virtually any range against these missiles. Unfortunately, second generation IR missiles are more "intelligent". They are "fooled" by IR jammers only at longer ranges. Even then the strobe pattern can be recognized by a seeker with advanced computer logic, and once recognized the seeker actually homes on the jammer, instead of being confused by it.

Therefore, it's unwise and sometimes downright dangerous to leave a jammer running when second-generation IR missiles are getting close (not to mention the jammer overheating and shutting off at an inconvenient time).

Flares: Although called "flares", these are really small, finely tuned heat decoys. A flare lures an IR missile toward it (and away from you), but only during the 2 to 3 seconds it burns. After that the flare dies and the missile resumes seeking. Therefore, like chaff, the standard technique is to wait until the missile is a couple of seconds away (the klaxon sounds), then drop a flare while you turn away.

Maneuvering: Maneuvering techniques against IR missiles are the same as those used against radar guided missiles. The only difference is that IR missiles tend to be smaller and more maneuverable. Second generation missiles are often the most maneuverable, so you're best off relying on decoy, jammer and/or flares against them.

Unlike radar guided SAMs, most IR SAMs are very maneuverable, with the ability to turn toward their target almost immediately after launch. As a result, flying low and close to a battery of maneuverable IR SAMs is very dangerous!

Warnings & Responses: Your first warning of an IR missile attack can occur at any time. A search or tracking radar may alert you, just like a radar-guided SAM attack. In fact, at that point you can't tell that an IR missile attack is coming. However, when the missile is launched, the "I" missile warning light goes on (rather than the "R" light).

In many cases your first warning of attack is the "I" missile warning light. This is because lots of cheap IR SAMs have no search radar — just eyesight searching. Your first warning is their launch.

If you know the missile is a first-generation homer, you can turn on the IR

Turning Inside a Missile

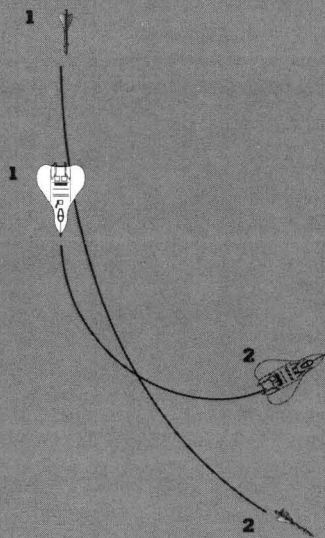

Here your F-19 turns so tightly the missile can't "stay with you" and passes harmless off to the right. This is a common tactic for evading IR homing missiles.

jammer, change course and laugh it off. However, it pays to be wary. Against second generation missiles the IR jammer may still work — if you can get outside its 45° field of view before it gets too close, or the jammer overheats. The reduced airspeed due to using the jammer doesn't help, either. Otherwise, you'll have to wait for the proximity alarm klaxon.

Many IR missiles are fired from very short ranges, so short that the "I" light is almost immediately followed by the proximity alarm klaxon. When you hear the klaxon and see the "I" light burning, your first act must be to drop a flare and then dodge!

Whether you're using jammers, decoys, or just plain guts, the basic principles of outmaneuvering a missile remain the same.

Evading the Missile's View: SAMs can only "home" on targets within the acquisition arc of their seeker. This arc is a bare 45° ahead of the missile. If decoys, jammers, or whatever temporarily confuse a missile, you evade attack by moving outside this 45° arc. Usually the quickest escape course is one perpendicular to the missile's flight path.

Turning inside a Missile: When a missile is close, you still have a chance to outmaneuver him. Its turning arc is larger than yours.

If the missile is trying to fly up your tail, roll over onto a wingtip for a tight turn, then pull back hard on the control stick to tighten the turn further. Keep an eye on the airspeed, since you can't stay long in this kind of a turn — soon the plane will stall. But meanwhile, the missile is making a wider, faster turn that causes it to zoom past harmlessly

Turning toward a Missile: If a SAM approaches you from the side, gradually turn toward it, increasing the tightness of your turn as it comes closer. The objective is to keep the missile's course at right angles (perpendicular) to your own.

This tactic works because the missile cannot turn with you. Instead it gradually falls behind, zooming past your tail.

Evading Frontal Attacks: If a SAM approaches you from the front, wait until it's about 8 to 12 kilometers away (about 2/3rds of a grid square on the tactical display).

Then make a quick 90° turn. This puts the missile facing your side. Now roll over 180° and turn toward the missile. Now you're set up for a turning battle (see "Turning toward a Missile" above).

Outmaneuvering a Missile

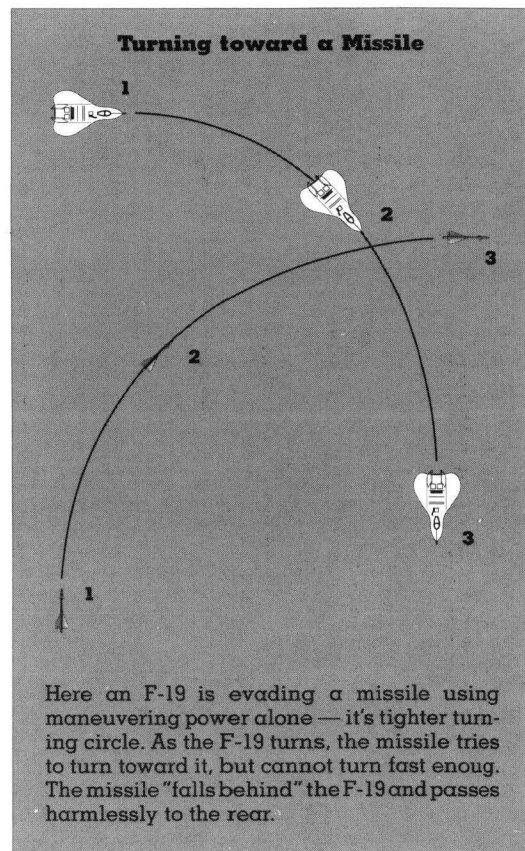

Special Tactics & Problems

The "Doppler Cross" Missile Evasion

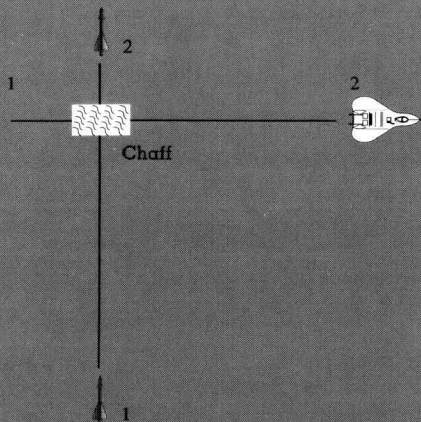

The F-19 observes an enemy doppler-guided SAM approaching (SA-10, SA-12 or SA-N-6), and until his course is perpendicular (at right angles to) the missile, as shown in position #1. Then the F-19 drops chaff (as shown) or a decoy, and continues on a perpendicular course, keeping the missile at a constant range. Flying on a different course can be disastrous, as the missile will "see" the doppler shift as you change range.

Missile Minimum Range: Large less-maneuverable missiles fire straight up when first launched. This means that they can't begin homing until they're beyond a certain distance (in range and altitude) from their launches. As a result, circling right over a battery of low-maneuverability SAMs can actually be very safe.

Doppler Missiles: Enemy missiles with doppler guidance systems are a special danger. These missiles will not home on the chaff unless your course is perpendicular (at right angles to) the missile. If the missile chases you from the rear or attacks from straight ahead, chaff has no effect.

Only three SAMs (Surface-to-Air missiles) currently have doppler guidance: the SA-10, SA-12, and SA-N-6. Only one AAM (air-to-air missile) has doppler guidance: the AA-10.

Air-to-Air Tactics

Attack Techniques

Missile Ranges: The maximum range of a missile depends not only on its motor, but your plane's speed at launch and the direction of enemy movement. The initial "lock-on" range corresponds to missile maximum range if you're at maximum speed. However, if you're moving slower the missile may not get that extra boost needed to reach the target.

A much more important consideration in the enemy's flight path. If the target plane is flying toward you, even a maximum range launch is likely to reach him. However, if the target plane is flying away the missile has a long "stern chase" ahead of it. In such a situation you should wait until the oval changes color before launching.

Radar Guided Missiles: Your AIM-120 AMRAAM missile is one of the best medium-range weapons in the world. It is the only "fire and forget" radar-guided missile in American inventory. It has sufficient circuitry to penetrate most defenses, and sufficient maneuverability to chase down most fighters, not to mention nailing bombers and transports. Because the AIM-120 has greater range than the Sidewinder (32 km compared to 17 km), pilots typically open fire with the AIM-120, then switch to Sidewinders if any enemy aircraft survive to that range.

IR Guided Missiles: The short-range AIM-9M Sidewinder is probably the best dogfighting missile in the world. It is more maneuverable than the AMRAAM, giving it a better chance of "hanging on" to a twisting, turning target. The most advantageous firing position for the Sidewinder is up the enemy's tailpipes. The next best position is from above, diving down onto the top (hot side) of the enemy plane. The third best position is directly into the enemy's nose. Shots against the enemy as it crosses in front or you, or at its underside (the cold side) have very little chance of hitting.

The main weakness of the Sidewinder is its limited range.

Technique: When firing a missile, always remember to (1) open the bay doors, and (2) wait for the lock-on. If you don't wait for the target box to become oval-shaped, you're firing without lock-on, and will almost certainly miss. Then look at your airspeed. If you're moving fast (around 500 kts) or the target is closing, a maximum range lock-on shot will probably hit. However, if your speed is low or the target flying away you should wait until the range closes, ideally until the circle turns color.

Missile accuracy doesn't take into account enemy defensive equipment or evasive maneuvering. First line and elite fighter aircraft may prove more difficult to hit. Although the "Mainstay" AEW&C craft maneuvers poorly, it has superior defensive equipment. You may find that guns are necessary against Mainstays flown by a capable crew.

Missiles

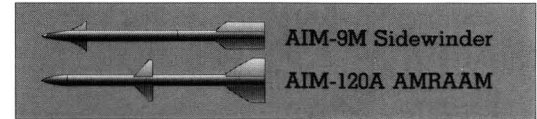

AIM-9M Sidewinder

AIM-120A AMRAAM

Firing Attitude: Also remember that AAMs, like other missiles, will fall 300' to 400' before their motor is powerful enough to guide them away to the target. Until then the missile has your speed and VVI. If you're diving at the ground, the missile may slam into the ground before it can fly away. Firing in a tight turn, or while inverted, can cause the missile to tumble as it leaves the weapons bay. The wisest method is to fire only when you're level and above 500'.

Target Discrimination: Sidewinders and AMRAAMs always home on the most prominent target, which is usually the nearest. They will do so even if you were tracking someone else. In Cold War and Limited War, beware of this limited "brainpower" in your missiles. You may be tracking a primary or secondary target, fire a missile, and then discover it goes for one of the fighter escorts that happens to be closer!

Notes: Your F-19 uses a tracking camera instead of weapon guidance radars. This system "downloads" appropriate launch parameters to the AIM-120 AMRAAM. Although the AIM-120 itself uses radar, the set switches on when the missile is launched. As a result, missile targeting does not increase your EMV. Of course, opening the bay doors to fire does increase EMV. A skillful stealth pilot only opens the bay doors just before a launch, or during a dogfight.

Guns



Jet aircraft travel so quickly that conventional machine guns and cannons cannot fire fast enough to guarantee a hit: a plane could literally fly between the shells. Therefore, modern aircraft cannons are either a group of guns (such as the twin 23mm cannons in many Russian MiGs) or a multi-barrel gatling gun (such as the six-barrel 20mm M61A1 on most American jets). Cannons are used because they fire explosive shells (machine guns fire less destructive solid lead slugs). Small 20mm to 30mm cannons are used because large weapons cannot fire fast enough.

Aircraft cannons have an effective range of 0.5 to 3 kilometers, a maximum range of 6 kilometers. Inside 0.5 kilometers there is a significant danger that a piece from a disintegrating target might hit you.

The Historical Gunsight: Your F-19 has the most modern and advanced gunsight available: a "historical" gunsight with automatic laser rangefinder. In normal operation this gunsight "assumes" you are firing at maximum range (6 kilometers). However, if your tracking box is on a closer target, that shorter range is used instead for gunsight calculations.

The gunsight computer constantly calculates range, flight path, and ballistics for you. It then displays where your shells *would be* if they were hitting the target now. The gunsight continually calculates firing, delays the appropriate time and displays potential hits as they would occur. Therefore, the sight is "assuming" that you fired at the correct time in the past (hence the term "historical" gunsight).

Anticipation Firing: It takes about two seconds for M61A1 20mm shells to travel the maximum 6 kilometer range. Therefore, to hit a target you must

judge the speed at which the target and your sight converge. You should fire about two seconds before they meet. If the range is less than 6 km, wait a little less. For example, at 3 km wait until target and sight are one second apart; at 1.5 km wait until target and sight are a half second apart, etc.

You can use this sight like an old fashioned predicting sight. That is, wait until the sight is on the target, then shoot. But at 6 km range you'll have to hope the target stays on the same course for two seconds to insure a hit. Airplane targets aren't always so obliging!

In short, the key to using a historical gunsight is anticipation. Don't wait for the sight to reach the target. Instead, learn to *anticipate* the meeting of sight and target, then shoot ahead of time.

Performance Limitations: Although the maximum range of your M61A1 20mm Vulcan cannon is 6 kilometers, this is not the recommended engagement range. At ranges beyond 3 kilometers accuracy falls off considerably. Also beware of firing at ranges less than 0.5 kilometers. If the enemy is any closer, you could be hit by pieces of wreckage.

Your 20mm cannon has a large ammunition supply, but the huge rate of fire means it goes quickly. Fire short bursts instead of long ones, especially against aircraft. "Hosing down" a target is extremely wasteful. If the shot is that difficult to achieve, you're crazy to waste ammo on it. In air combat cannon shots are usually very good or very bad, with very few intermediate cases.

Notes: The historical gunsight requires conscious "retraining" to use well, since it doesn't require you to "place the sight on the target". However, this weakness is more than compensated for by the advantages of anticipation firing. The sight allows you to fire sooner, and more accurately, than any other sight in existence. The historical gunsight is the device of choice among "in the know" fighter jocks.

The gunsight on this model uses a laser rangefinder slaved to the tracking camera, rather than the traditional ranging radar. This means you can use your gun without increasing your EMV.

Air-to-Air Duels

The Ambush

The best way to start air-to-air combat is to surprise your opponent. Enemy aircraft have only forward-facing radars (except the Il-76 "Mainstay" AEW&C craft). The best way to ambush an enemy plane is to slide up behind him.

Traditionally fighter pilots prefer to attack from above. This gives them an energy advantage in any dogfight. However, missile tactics and the importance of secrecy make a height advantage less valuable for a stealth pilot. Gaining height makes you visible to enemy radar, which in turn will certainly warn your targets. Therefore, approaching low and from behind is often wiser. Only if your missile attacks fail and the enemy discovers you should you begin to seek an altitude advantage.

If you're surprised or "bounced" (attacked from above) by the enemy, imme-

diately look for incoming missiles and take appropriate defensive action. Missiles arrive faster than aircraft, and therefore must be avoided first. Only then can you begin dogfighting or attempt to escape.

The Missile Exchange

Often an air-to-air battle starts because the enemy has discovered you, and vectors fighters in your direction. The result, quite frequently, is a head-to-head face-off, you against him.

In this western-style showdown each side starts with an exchange of long- to medium-ranged radar missiles. Be prepared to decoy, jam, and possibly chaff the "incoming". Once your radar missile is away, switch to an AIM-9M Sidewinder. You may get a second close-range missile shot if the AMRAAM fails. Scoring with a head-to-head cannon shot is much more difficult, and not worth the ammo unless either (a) you're out of missiles, or (b) you're an incredibly good marksman.

Naturally, if you can get off a second missile shot, so can the enemy if he carries second-generation IR missiles (the AA-8 or AA-10 IR version). These nasties show up frequently on MiG-29s and Su-27s, but aren't unknown on other craft flown by Veteran or Elite pilots.

The Early Turn: One of the most difficult, but most useful tactics in a head-to-head match is making an early turn (see diagram). Against inexperienced pilots this trick is easy, since greenhorns usually keep boring in, hoping for a cannon shot, and only thinking about a turn after they've passed you. Against vets and better an early turn requires fine timing. If you turn more than a second or two ahead of the enemy you're just telegraphing your intentions. If you wait too long, you get no advantage at all.

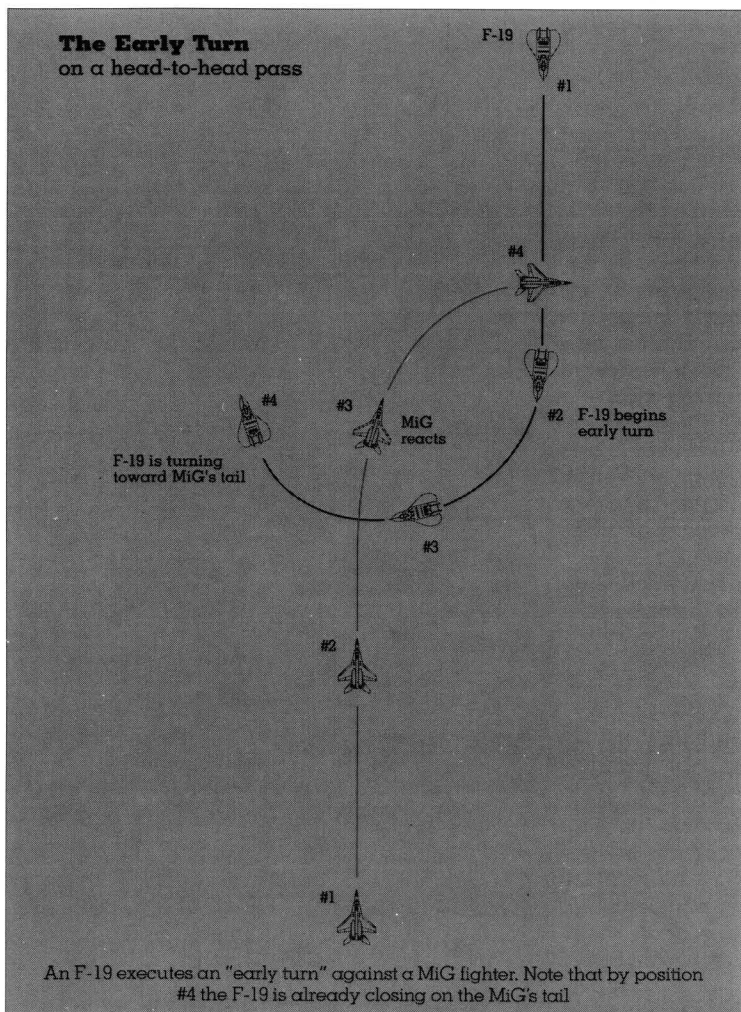

Enemy Missiles

Radar-Homing AAMs: The Russian AA-10 Alamo is a “fire and forget” missile just like your AIM-120 AMRAAM. All other Russian radar-guided weapons are semi-active homers. Here the launching aircraft must continue to “paint” you with its radar — the missile homes on the “paint”.

You avoid radar-homing AAMs just like SAMs (see Air-Ground Tactics, Defensive Tactics Against SAMs, page 00). That is, use reduced EMV, ECM jamming and ultimately chaff. Decoys can be very effective. Note that the MiG-25 and MiG-31 carry extremely long-ranged radar SAMs. Low EMV, ECM and decoy tactics are especially effective against these weapons.

Consider yourself fortunate that none of the Iranian F-14s have operational Phoenix missiles. These long-range killers are especially difficult to evade.

Infrared (IR) Homing AAMs: All IR homing AAMs are “fire and forget” weapons. Of these the AA-8 is the most dangerous because of its second generation IR seeker and great maneuverability. If enemy MiGs and Sukhois close to AA-8 range (8 kilometers) you’re often in trouble.

Techniques to evade IR AAMs are the same as those used against IR SAMs (see Air-Ground Tactics, Defensive Tactics Against SAMs, page 00). That is, use the IR jammer at long range, flares at short range. The decoy also works.

In practice, many IR homers are fired at short ranges during a dogfight. This means you’ve got to leap onto the IR jammer when you get a launch warning, then dodge out of the missile’s 45° field-of-view immediately. At dogfighting ranges missile flight times are very short — you don’t have time to fool around! If this fails, or you delay too long, the missile approach klaxon will go off. Now you’ve got bare seconds to react: dump a flare immediately and dodge, or you’re history.

One nice thing about IR AAMs is that the older AA-2, AA-6 and AA-7 designs all use first generation seekers. The enemy must get on your tail before these missiles lock on. Keep him off your tail and you avoid this entire class of weaponry. Of course, doing that requires dogfighting skills.

The essential rule in dogfighting is to get on the enemy’s tail. On all fighter aircraft, guns and missile guidance systems only face forward. If you’re on the enemy’s tail, you can shoot and he cannot. If you can’t get on his tail, at least try to place his aircraft ahead of you as much as possible, so you have the maximum number of firing opportunities.

Maintaining higher speed or altitude is valuable in a dogfight. A plane slower and lower can only dodge attacks. A plane faster or higher can attack or retreat as desired. Having a higher speed or altitude is termed the “energy advantage”.

If the enemy is behind you, there are various classic escape maneuvers: Turning Inside, the Scissors, the Immelmann, the Split-S, and the Yo-Yo. Not only should you learn them, but also learn to recognize these maneuvers so you can apply the appropriate counter-maneuver.

Turning Inside: The simplest solution to an enemy plane coming up

Dogfighting

Scissors Turn

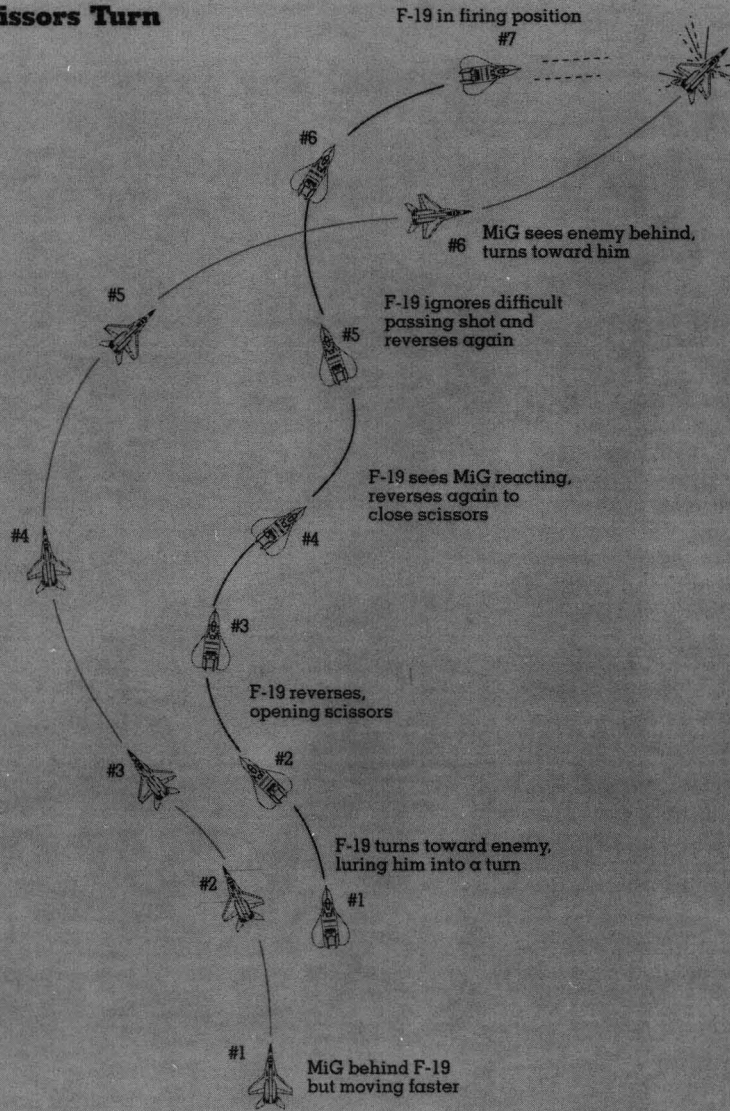

behind you is — turn toward him (i.e., turn in the direction of the enemy aircraft). If you're turning faster than he, you'll gradually circle around and get onto his tail. This kind of a "turn match" is frequently seen when green-horns dogfight.

Of course, if the enemy is turning faster than you, he will eventually come around behind you. If this happens try something else immediately. The longer you wait the worse it gets, until he lines up a shot and toasts you.

Scissors: A more complex way to out-turn an enemy aircraft is the scissors maneuver. Begin a turn toward him, but once he begins to turn with you, quickly roll over to turn in the other direction. This opens the scissors. As the enemy realizes you've turned away and turns toward you again, you reverse the procedure and roll back toward him again. If your turns were quicker and tighter than his, and/or you're a slower plane, he will eventually pass in front of you. This allows you to get onto his tail.

Novice pilots trying to turn with you can be lured into a scissors with ease. Even if their planes turn better, their slow reactions to each scissor opening and closing will quickly give you the edge. More experienced enemies may avoid this tactic by anticipating your next turn and blasting you (if they're less maneuverable), or by pulling up and over in a yo-yo (if they're faster).

Immelmann Turn: This maneuver is an excellent way to reverse direction quickly. First you perform a half loop upwards to reverse direction, then a half roll to right your aircraft. If an enemy aircraft is behind you, an Immelmann can bring you nose-to-nose with him.

The original Immelmann, a German WWI fighter pilot, reputedly rolled while vertical, allowing him to finish the loop in whatever direction he desired. He still finished the half-loop inverted — it's aerodynamically more efficient that way.

Note that an Immelmann gives you to an

altitude gain but costs speed, since a half-loop upward slows you down significantly.

Split-S Turn: This maneuver complements the Immelmann. Begin by rolling inverted, then pull the stick back to half-loop downward. Many pilots begin the loop before the roll is completed, rolling the plane while looping. The split-S causes you to lose considerable altitude, so it's often wise to reduce throttle and/or use speed brakes to minimize altitude loss.

The Split-S complements the Immelmann because you gain speed and lose altitude. Unwary fighter pilots have sometimes tried to Split-S into or away from the enemy without remembering their altitude. The result can be a Split-S right into the ground!

Yo-Yo Turn: This maneuver is used mainly by higher speed jets against slower opponents. Therefore the relatively slow F-19 has little occasion to use it dogfighting. However, you may see enemy MiGs attempting it against you! This turn also requires excellent cockpit visibility, something that both the F-19 and early MiGs lack.

In a Yo-Yo turn you climb and roll toward the enemy — until he's visible out the top of your canopy. Then pull over into a dive while still turning. During the dive you roll the plane to help line up your shot. Very often you'll take that shot while inverted. Don't let it bother you.

Because a Yo-Yo requires good spacial perception, first practice it using the Slot View (if alone) or Tacti View (if you've got a target). In combat conditions switching to a wide angle view is extremely helpful in pulling the HUD around onto the enemy after you come over the top. Then you can switch back to normal view again.

In effect a Yo-Yo plane makes a very big turn in three dimensions. Most of the turn radius is "consumed" with the climbing and diving, allowing a faster plane to travel further and turn wider, yet still come out on the tail of the more maneuverable plane. American F-4 Phantom pilots used this maneuver with great success against slower but more maneuverable MiG-21's over North Vietnam during the Vietnam war.

Note that the best defense against a Yo-Yo is to

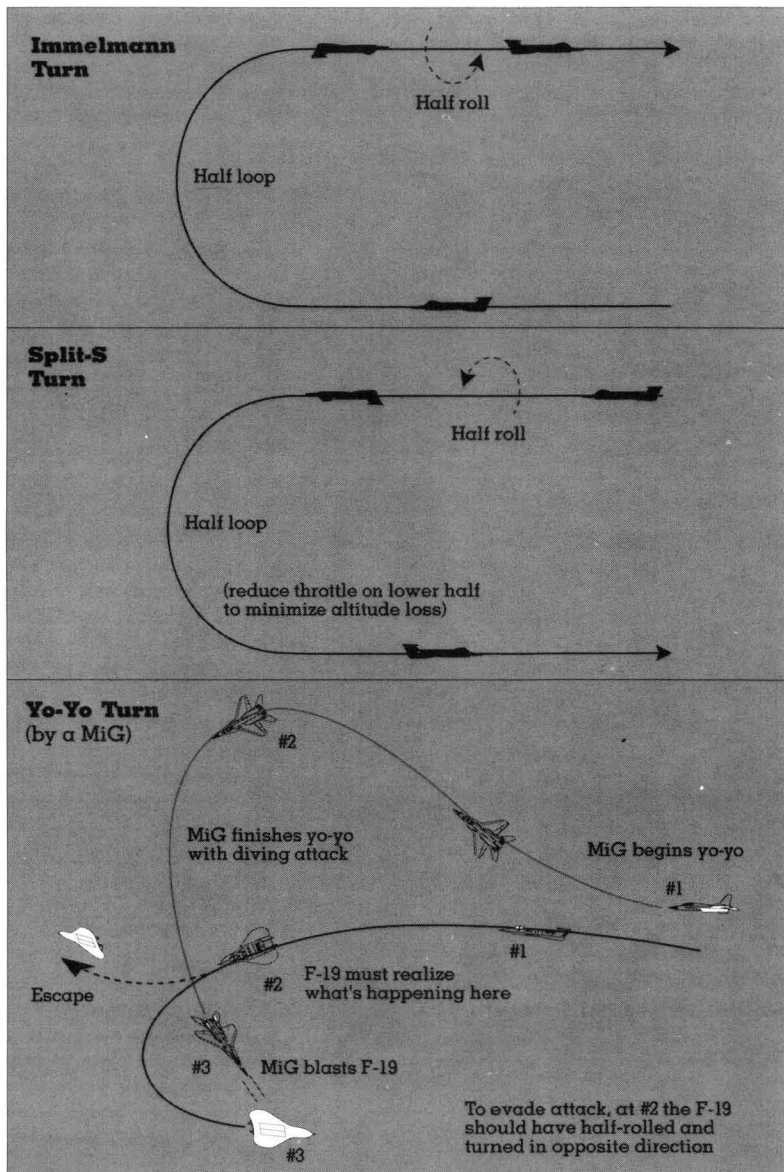

reverse your turn, or to use the third dimension yourself (usually by going into a split-S).

Enemy Guns

The enemy has cannons equivalent to yours in range and power. However, the enemy still uses old predicting gunsights. This means they are virtually required to get behind you before they can make a decent shot. In addition, all but the most elite pilots will be slow to fire, since they must place the gunsight on the target and keep it there to score a hit.

If you sense the enemy is behind you and ready to fire cannons, "jinking" (small, violent moves in random directions) can throw off his aim.

Finally, Russian-built aircraft with the older GSh-23 cannon may not always hit, since the lower volume of firepower increases the chance of you "flying between the shells" and escaping serious injury. Don't rely on this, though — not every 23mm shell is an unlucky one!

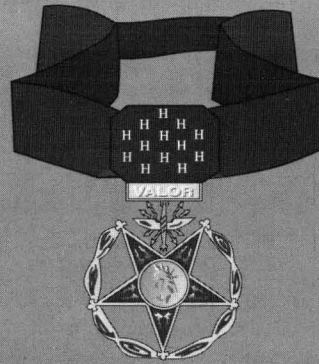

The Congressional Medal of Honor is America's highest military decoration. According to the United States Department of Defense, it is awarded for "conspicuous gallantry and intrepidity of the risk of life, above and beyond the call of duty, in action involving actual conflict with an opposing armed force".



MISSION BRIEFINGS

4

Rules of Engagement (ROE) outline what targets a pilot can and cannot attack. In an age of nuclear weapons unrestricted warfare would destroy the planet within 24 hours. Therefore, all wars are limited to some degree. If warfare is limited to just a local area with specific goals, ROEs are much more restrictive. If an official state of war does not exist then the rules will be extremely restrictive.

In stealth missions, ROEs also determine what "exposure" of your aircraft is allowed. In cold and limited war situations it is important that the enemy not know exactly who or what performed the attack. This allows the politicians to say whatever they want.

ROE: "You may attack and destroy a target only if it is specifically required by your mission orders. You may engage other targets only if they fire first, or if they have spotted your plane. The mission is completely clandestine. You must avoid detection, especially visual detection by enemy aircraft. Enemy air or ground forces that do detect you should be destroyed, to prevent embarrassing disclosures. Neutrals and civilians must be considered friendlies, and above all you should avoid detection by neutral aircraft and radars."

Background Notes: In cold war situations the State Department must have "deniability" for every mission. If the mission is successful and the political climate seems good, the USA may claim credit for the deed. In other cases, however, America may not wish to attach its name to the action.

You are warned when enemy radar returns are good enough to spot your craft, or when enemy aircraft come close enough to visually identify you. These enemies should be destroyed, although the effort can be counterproductive if the attack generates lots of additional sightings!

Gratuitous or wanton destruction of all other targets is very bad in cold war. Hitting targets of value to the civilian sector, such as bridges, oil wells and tanks, refineries, etc., is especially bad. Your record will rapidly accumulate

Rules of Engagement

Cold War Situations

black marks if you act like "Rambo" during the Cold War. After all, Rambo is fiction, this is reality!

Limited War Situations

ROE: "You will engage and destroy all targets specifically required by your orders. In addition, all other targets with active weaponry (i.e., which could fire on your craft) may be attacked. You may engage these military targets even if they haven't see you yet. You may never attack non-military targets unless so required by your orders. Neutrals must be considered friendlies at all times, and in addition you should avoid detect by neutral aircraft and radars at all costs."

Background Notes: In limited war the State Department may require deniability, since American aid to the contestants may need to be secret. However, since there is a war, and military targets get destroyed in war, you can attack military targets of opportunity and be rewarded (rather than penalized) for your efforts. However, hitting non-combatant targets of value to the civilian sector (unless ordered to) is forbidden.

Conventional War Situations

ROE: "You engage attack and destroy all targets specifically required by your orders. In addition, any and all other targets in enemy territory may be attacked, including civilian targets. If able to select additional targets, select those with immediate military capability first. Neutrals must be considered friendlies at all times, and in addition you should avoid detect by neutral aircraft and radars at all costs."

Background Notes: In a conventional war you are allowed unrestricted conventional attacks on enemy territory. This includes civilian targets formerly forbidden. However, targets with immediate military capability are more important. Therefore, destroying enemy aircraft, airbases, SAMs, radars, depots, headquarters, etc., gives more reward than bridges, oil refineries, oil wells and platforms, etc., whose importance is long-term. This is because even conventional wars are fought for short-term goals (such as the Grenada invasion in 1983, or the Falklands Islands campaign of 1984).

However, from a pilot's point of view, conventional war is "fun" because anything in enemy territory is fair game. Of course, the disadvantage is that the enemy are prepared and alert for intruders.

ONC Map Coordinates

ONC maps use the standard US Army military grid system for locating positions anywhere on the globe.

The maps are divided into large squares. Each square is identified by a two-letter code, such as WX, JC, etc. Within each square are smaller rows and columns, ruled into smaller squares. These smaller squares are identified by column and row number from 0 to 9. Following the "read right and up" rule, the column number appears first, then the row number. This is the same as basic algebra, where the "x" horizontal value is given first, then the "y" vertical value.

For example, coordinate JC79 means large map square JC, column 7, row 9.

Missions

Air-Air Missions

Selecting Armaments

In limited or conventional war situations the AIM-120A AMRAAM is the missile of choice. You can lob these at the enemy from a full 30 kilometers range. If you're firing at a plane with close escorts, space the shots 5 to 10 seconds apart (the higher their altitude, the longer the spacing). This is because a burning, exploding plane is a prominent target to the missile's seeker. If your missiles arrive right behind one another, those following may home on the plane hit by the first. Worse, the terminal homing of the AMRAAM is somewhat questionable — it tends to take the closest target at the time, rather than the target you originally designated! Therefore, when shooting into a group you can't count on which plane will be hit. Finally, if the enemy is veteran or elite, don't be surprised if the enemy manages to outmaneuver your missile by turning inside it.

In cold war, guns are the weapon of choice. With these you can insure the proper target is hit, and no others. Unfortunately, getting close enough for a shot may reveal your presence. A good compromise is the AIM-9M Sidewinder, a fast-turning close-in dogfighting missile. It's usually easy to line up a 5 to 8 km shot, where the Sidewinder has a clear run at the target and nobody else is likely to get in the way.

Here an important personage is travelling by plane; your job is to make sure he doesn't arrive! The plane takes off about the same time as your own. Remember that his plane, your objective, is the flashing dot on the satellite/radar map (on your left-side cockpit CRT).

Although it's possible to just fly to his destination and wait, roving fighter patrols or local air defenses eventually will spot you. In general, the wiser approach is to find the best way to "sneak through" enemy patrols and SAM radars to intercept him *en route*.

In limited or conventional war you can take down his plane and escort with AMRAAMs. In a cold war situation you'll need to close for a clean Sidewinder or gun shot. Remember, though, that if the fighter escorts get a visual ID on your plane you must to "zap" them too. If your attack location is well away from any ground radars or Mainstay AEW&C planes, you can attack from above, hit your man, drop a decoy to confuse them, and zoom away with maximum speed at low altitude (say 200').

In this mission you know a transport plane, accompanied by fighters, will head for friendly territory. Your objective is to eliminate them before they arrive. The problem is, you don't know their destination.

As you take off, watch the enemy aircraft carefully. Circle around a bit,

Ambushing a Leader

Intercepting Terrorists or Commandos

observing their course until you can guess their objective. Once you know their goal, it's easy pick a nice quiet spot to ambush them. Often you can stay in friendly territory all the way! Properly executed, this mission is a nice, easy milk run.

Eliminating a Fighter Patrol

Enemy fighter patrols have a nasty habit of lurking near their own air defense systems, and/or being supported by Mainstay AEW&C planes. Going in after them can cause quite a battle.

One trick to avoid this mess is to publicize your presence in a nearby area. You should pick an area with little or no SAM coverage, and with no nearby airbases. If you can lure the fighter patrol to you, at this spot, the battle may be much easier. The typical way to accomplish the lure is to raise your EMV (by flying high, turning on the ECM, and opening the bay doors). If that doesn't work, clobbering a thing or two on the ground may catch their interest.

Once you've "dangled the lure", it's wise to take a low profile again, so you can ambush the enemy fighters as they arrive. As in many other aspects of modern warfare, getting the first shot is a big advantage.

Destroying a Recon Bomber

In most cases you must chase an enemy plane on its way home. Catch and attack him as quickly as possible. The longer you delay, the closer he gets to SAM cover and fighter aid. This is one mission where climbing to a higher altitude can be rewarding — you travel faster, farther at high altitude than low. Of course, don't go so high that you wake up the enemy and attract lots of fighters and missiles!

Attacking a Cruise Missile

These aircraft are most unobliging targets. They cruise around deep behind their own lines, guarded by SAMs and closely escorted by fighters. Given the defenses, attacking these planes is like hitting a ground target. You need to sneak or punch your way through defenses, elude counterattacks, and blast the primary, just like a strike mission.

Taking Down the Mainstay

The Il-76 "Mainstay" AEW&C plane is the most difficult aircraft target. Sooner or later its radar will see you, forcing you to fight through fighters and SAMs to reach it. Make your approach as stealthy as possible: it postpones this hour of reckoning. Destroying one or two crucial SAM radar sites on your way in can be useful — it opens a radar-free corridor to the target, and at the same time may draw off enemy interceptors, perhaps even some of the Mainstay's fighter escort.

Strike Missions

Choosing Your Weapons

Selecting armaments for ground attacks is always difficult. The favorite weapon is the AGM-65D Maverick missile. It's your longest-ranged ground attack weapon (30 km; the Harpoon fires farther but is only good against warships). The Maverick's also an accurate "fire and forget" weapon. Its only

weakness is that one missile can't always do the job (see the Weapon Effectiveness Chart on page 131 — ratings below B- mean the missile may not destroy the target). Fortunately, Mavericks are just fine against radar installations. Most pilots carry as many as they can afford, and fear the day when the crew chief tells them no more are available.

Choosing between laser-guided bombs, retarded bombs, and free-fall bombs is often a matter of personal preference. Many times more than one weapon will do the job, so you can pick a type whose attack run suits your style. Other times you may be forced to use a certain weapon because nothing else does the job right.

When choosing weapons, don't expect much from a weapon rated C or D against a target. Scoring a hit with such always requires a lot of luck. Certainly don't rely on such to take out your primary target. Weapons rated A or B can be relied upon, provided you deliver them accurately.

Dropping off or picking up items deep behind enemy territory seems rather straightforward. After all, you don't have to fly into SAM batteries or go head-to-head with fighter patrols.

Instead, a secret airstrip challenges your flying skill. You must manage a landing without an ILS to guide you. Worse, the strip is only half the length of a normal runway. You must land gently, at low speed (under 160 kts, preferably), and touchdown near the start. Otherwise you'll roll off the other end and crash! To make matters worse, the strip's lights are only for a limited time. Make a note of the time the lights go off, then periodically check the Waypoints screen on the right-side CRT (tap *Select Way Pt* key) to see how much time you've got. Once the lights are out landing is virtually impossible.

If your opponents are skillful, their intelligence may have dangerous information about this mission. You could find enemy fighter patrols uncomfortably close to your objective, or bouncing you just as you're trying to land!

These missions are usually "milk runs". Your job is to avoid action and just fly over a radio beacon that's quite clear on your HUD. The only real worry is reaching the beacon before it is turned off. Make the note of the "turn off" time and periodically check the Waypoints screen on the right-side CRT (tap *Select Way Pt* key). Once the beacon turns off there's no way to find the drop site.

Be warned that skillful opponents may have intelligence about this mission from their spies. You could find enemy fighter patrols lurking around the objective. If so, you could attempt to lure them away, or blow them away, depending on your ROE (rules of engagement).

There are two hard things about photographic missions: using the camera, and keeping a low profile while you're doing it!

Because the 135mm/IR camera is on a fixed mounting, you must steer the plane to aim the camera. This is more difficult than it seems, since the target swims into and out of view all too fast. Experienced pilots advise you to line up

Secret Airstrips

Airdrops

Photo Recon Runs

on the target 8 to 10 km away. Set up a perfectly straight course and keep to it. At 2 km to 4 km hit the bay doors and brakes, then pull the nose gradually up, bringing the camera's aim onto the target. Keep in this regime, using subtle pitch changes to keep the target in the camera, while snapping pictures. You've got plenty of film: don't be afraid to take plenty of extras!

Success is announced right on the CRT. As soon as you have it, close the doors and brakes, then dive low for your escape. Don't be surprised if the enemy spots you during the photo run.

Photo runs over enemy troop concentrations and/or near SAMs are especially nerve-wracking. You may need to take out a SAM radar before making the run. If shoulder-fired SAMs infest the area, your only hope is to dump a decoy before your start, run your IR jammer as long as you can, and/or periodically dump flares.

Flying against SAMs

Destroying a SAM battery requires that you "sneak up" on them as best you can, then nail his radar first with a Maverick or HARM. With the radar out of action, the missiles are helpless. Unless there are other SAMs nearby you can have a strafing "picnic" with the missile launchers until a fighter patrol shows up.

Remember that the safest place around a SAM battery is directly above it. The radar cannot look straight up, and the longer-ranged missiles (such as the SA-2, -5, -10 and -12) have a minimum range of 4 to 5 km. Of course, getting to this point can be rather tricky. It doesn't hurt to run over the litany of defense techniques before going after a SAM: disappearing, decoys, ECM, chaff and maneuvering.

Hitting the Sub Pens

The Severomorsk submarine pens in the North Cape are a unique and special target. These must be attacked by toss bombing from the north: you must place an FAE *through* the sea doors. This means flying straight at the mountain, pulling up at the last minute. You may wish to make your run at 500' to 1,000', instead of 200'. This lets you begin the toss sooner (about 3 to 4 km away), giving you more leeway to clear the mountainside.

Beware the Krivak-class frigates that patrol seaward of this submarine base. Their radars and SAMs cannot be ignored! You'll want to bring along a couple Penguin-3 ASMs to eliminate these fellows. Even in Cold War, chances are good a Krivak will get a radar "make" on you, forcing you to hit him.

Sinking Ships

The ideal ship-killer is the AGM-84A Harpoon. This heavy missile is your longest ranged weapon. It has a superb targeting system that hits the ship you target, even a carrier with a ring of escorts.

However, don't underestimate enemy warships, especially those of the Russian Northern Fleet. The larger ships have exceptionally good radars and very powerful SAMs. Patrol ships can be knocked out with a single missile, but a task force has so many ships that any close approach means you'll be dodging missiles left and right.

Most enemy ships stay close to friendly shorelines, with fighter cover nearby (if not overhead already). Don't forget that enemy aircraft carriers have their own fighters: you can count on a few flying CAP (combat air patrol).

When fighting a conventional war with Libya, or in the Persian Gulf, be careful about attacking merchant ships. Avoid those on the high seas or near friendly coastlines; only attack ships close to enemy ports or shore. Otherwise, you could end up hitting a neutral ship by accident.

When attacking with laser or free-fall bombs, you'll have to rise above minimum altitude during the attack run. This, combined with the open bay doors, raises your EMV considerably. Try to minimize this exposure as much as possible. Remember, the higher your EMV, the better target you are for enemy missiles. The longer you're a big target, the more chances the enemy has to launch and hit you.

The most frightening prospect is a bombing run directly over enemy troop concentrations. There's nothing worse than a host of shoulder-fired SAMs rising up at you. These are on the one missile site you can't knock out. Fortunately, they have very short range. Still, flying through a barrage of SA-14s, dumping a flare every two seconds, while trying to line up a bomb, will turn your hair prematurely white.

Bombing Runs

Libya

Introduction

Politics: Libya is ruled by Col. Mu'ammar al-Qadhafi, leader of the secret army organization that deposed the former king in 1969. The capital city is Tripoli and the nation's chief source of wealth is oil sold to western nations.

Military Forces: Rich by third world standards, Libya buys most of its armaments from the Soviet Union. Personnel are trained by Soviet military advisors, but national pride has prohibited (so far) any significant Soviet presence. Soviet advisors are not invited on combat operations.

The Libyan Army has approximately 60,000 men, the Navy has 53 ships and 6,500 men, while the Air Force has about 530 planes, 30 combat helicopters, and 8,500 men. A paramilitary "Pan-African Legion" of about 10,000 also exists.

In addition, Libya has built and supported a variety of training camps for terrorist groups.

Geography: Libya is a desert nation. Along the coast it has only one mountain region that is visually distinctive: the Jabal al Akbar to the east of Benghazi. These mountains greatly restrict the capabilities of Benghazi and Benina radars. Deep in the desert, east of Sabha, are the more desolate and isolated mountains of the Al Haruj al Aswad, while to the west are the great sand seas (ergs).

Level of Conflict

Cold War: At times Libya has been enthusiastic backer of international terrorist organizations. It provides funds, arms, military training, and base camp sites for a variety of Arab and other terrorist groups. America has already attacked tactical military targets in retaliation for Libya's role in numerous incidents of international terrorism in Europe and the Mediterranean.

Limited War: The Libyan army has fought minor border clashes against Egypt to the east. Egypt is an American ally, and so far has proved considerably superior, militarily, to Libya. The Libyan army has also attempted an invasion of Chad to the south. After a protracted campaign against Chad and her ally France, Libyan supply lines through the Sahara desert were cut, forcing a Libyan retreat. Future limited wars between Libya and any of her neighbors are possible.

Conventional War: In the event of NATO-Warsaw Pact conflict in the Mediterranean and/or Europe, Libya is expected to provide bases for Soviet aircraft and warships operating in the Mediterranean. These bases could become the westernmost outposts of Russian forces contesting the Mediterranean.

Friendly Bases

Sigonella on Sicily (UD15): The USA maintains a military base at Trapani, on western Sicily, and the Sigonella military field in southeastern Sicily. The Sigonella runway is the main staging point for air attacks against the North African coast, especially Libya. Unfortunately, the flight distances are quite long. Using this base virtually requires that your F-19 carry extra fuel.

CV America at Sea (UD70): This 60,000-ton "Kitty Hawk" class conventional aircraft carrier, designated CV66, often serves with the US 6th Fleet in the Mediterranean. It participated in the 1986 raids against Tripoli and Benghazi. The carrier is ideally positioned for launching and recovering strikes against Benghazi, the Gulf of Sirte, or targets deep in the Libyan desert. Here it cruises on a southerly course with its traditional ring of close escorts. The carrier remains well north of the Gulf of Sirte to avoid SSM attacks from enemy ships and aircraft. It is surrounded by escorts and regularly replenishes the CAP (combat air patrol) with F-18 launches.

These airbases are in neutral territory. You should not use these bases unless specifically so ordered, or if you must make an emergency landing.

Suda Bay on Crete (VD41): This airfield, near the city of Khania, is not an American base, although in years past it was a major NATO air and naval base. It has the advantage of being both closer and less public than equivalent airfields in Greece or Egypt.

Halpar on Malta (UD13): This airfield is on the island of Malta. Once a critical strength position for the British Commonwealth in the Mediterranean, it is now a neutral port and sometime tourist haven.

Flying over Libya is a unique experience. It is a truly desert nation, a land of red and brown hardscrabble with patches of tan sand and gray boulder fields. Water is all underground, seeping to the surface in occasional patches of green oasis or mountain valley. Mountain ranges are low, undulating areas full of small hillocks and short peaks. From the air it's often hard to tell the difference between aging roadways and the dark wadis (gullies) in the desert. But some works of man stand out, particularly the rust red of oil wells and pipelines, or the distinctive star-pattern of SAM batteries.

Tripoli (TC87): The capital city of Libya has a large military-civilian airbase at Idris, and is well protected by SAM batteries. Until recently these were long-range SA-5 Gammons, but there are indications that Russian military advisors may replace these with the formidable SA-12 Gladiator.

Tripoli is also the site of a major army headquarters, various military depots, oil storage areas, and sometimes terrorist training camps. Missile boats often cruise off the coast.

Sabha (UB17): This southern town is the main military base supporting Libya's southerly border expansion. It was the major depot for the Chad war, and is still extremely important to Libyan trans-Saharan ambitions. The most important military installations here are the large airbase and the SAM battery protecting it.

Misratah (UC26) & Sirt (UC43): These two coastal towns are much smaller areas, with lower level military headquarters. The ports include oil storage tanks for refueling ships. Sirt is a secondary naval base, supporting missile boats that cruise the western side of the "Line of Death".

Neutral Bases

Seeing the Sights in Libya

Libya

Ras Lanuf (UC82) & Port Brega (UC92): Ras Lanuf is Libya's largest and newest oil facility. The majority of all oil for export is stored here, and a large number of oil tankers are usually coming and going at all times. There is also a refinery, vast "farms" of oil tanks, and a major military headquarters. Port Brega is older oil facility, still in operation despite the completion of Ras Lanuf.

A number of SAM batteries are sited in this strategically vital area. In addition the Port Brega airfield, west of the town, serves both ports.

Benghazi (VC16): This city is the site of Libya's second-largest military base, including the Benina airfield and powerful protective SAM batteries. The city itself is large, with a military headquarters and a few small oil storage facilities to serve the ancient port. Terrorist training camps are not uncommon in the hills to the west.

Al Badya (VC37): This sleepy coastal town in the mountainous Jabal al Akbar has major military significance. It overlooks the narrow Ionian sea between Libya and Greece, making it an ideal site for anti-ship missiles. There is a small airstrip and SAM site as well.

Oil Fields: The great oil fields of Libya are in the southeast, where literally thousands of wells pump crude from the ground, which is piped to Ras Lanuf and Port Brega. The great producing fields can be found near Raguba (UC90), Waha (VB18), Amal (VC30), Jalo Oasis (VC40), and Gialo (VB49). Most of the great fields have a few storage tanks on site, to hold crude temporarily until it can be piped to the port. However, the majority of storage tanks are at the ports, not here on the fields.

Secret Bases: Western intelligence operatives in Libya are preparing two secret, hard-pack surfaces suitable for aircraft landings. One is at Al Mukhayli (ONC VC43), the other is on the edge of the great ergs, at Yafran (ONC TC93).

Air Defenses

Libyan air defenses use Russian-built equipment. Russian advisors train native Libyan crews, who then operate the equipment. SA-2 Guideline and SA-5 Gammon SAMs have been the backbone of Libyan air defenses, but there are rumors of upgrades to the new SA-10 Grumble and SA-12 Gladiator systems.

Local military forces make use of the SA-7 and SA-14 shoulder-fired missiles. These are also popular terrorist weapons, and can be expected in the vicinity of terrorist camps. Libyan army units use various medium-range SAMs, including the SA-8, -9, -11 and -13. However, these are not always in the best state of repair.

Air Force

Fighters: The Libyan Air Force is primarily composed of MiG-23MF "Flogger" fighters, with over 140 craft in inventory. It also has a smaller number of MiG-25 "Foxybats" for reconnaissance and long-range interception, as well as some antiquated MiG-21s. The Air Force also has various Mirage 5D fighter-bombers for ground attack missions.

Intelligence expects that MiG-23s and 25s will be your primary air-to-air opponents, although in Conventional War, or against higher quality pilots, you

may encounter the new MiG-29 "Fulcrum" flown by Soviet personnel.

Reconnaissance Bombers: Although Libya does not possess any Tu-95 "Bear" reconnaissance bombers, Russian planes of this type frequently operate from Libyan bases.

Airborne Early Warning & Control: Libya has no AEW&C craft. No Russian Il-76 "Mainstays" are expected to use Libyan bases, since they are too precious. In wartime Libya is a distant outpost in the middle of NATO's great strength in the Western Mediterranean. Aircraft losses would be high — too high to permit risking the rare and costly AEW&C craft.

Air Transports: It is suspected that Libya's antiquated fleet of C-130H and C-47 air transports (built in America) will be replaced with Russian equipment, perhaps including the new An-72 "Coaler" jet transport.

The Libyan Navy is primarily composed of Missile Corvettes and Missile Patrol Boats. The largest of these are the 770-ton Russian-built Nanuchka II class armed with Styx surface-to-surface missiles, SA-N-4 surface-to-air missiles, and a twin 57mm gun turret. The other boats include the Russia Osa-class, Italian-built Wadi M'ragh class and the French-built La Combattante II types; these have poorer missiles and SA-N-5 SAMs, or no SAMs at all.

The Nanuchkas are the best boats in the Libyan Navy. They perform the most aggressive patrols, making them the primary threat. Patrols occur frequently in the Gulf of Sirte, south of the "Line of Death." Sometimes the Libyan air force flies fighter missions in support of the patrols.

Navy

The Persian Gulf

Introduction

Politics: Iran has been ruled by Shi'ite (a Moslem sect) radicals since their overthrow of the pro-American Shah in 1979. In September, 1980 Iraq attacked Iran, beginning a long, costly war between those nations. Both contestants are viewed with distrust by the Arab states along the south of the Persian Gulf. Iran's use of international terrorism as a tool of foreign policy has not improved the nation's image.

Iran also calls for a Shi'ite religious revolution throughout the Islamic world. This naturally bothers the leadership of the Arab states, since their governments are Sunni (another Moslem sect). However, Iran is populated by Persians, not Arabs. So far this cultural and linguistic barrier has hindered the spread of Iranian Shi'ite radicalism across the Persian Gulf to the Arab states.

Military Forces: Under the Shah, Iran's oil-rich finances permitted massive investment in military forces, mostly from the USA. Since the revolution many complex weapons have failed for lack of spare parts and maintenance, while most of the rest were damaged or destroyed in the war with Iraq. Iran has some sophisticated aircraft and missiles remaining, but these are deployed to protect key cities in the interior, rather than as a border defense.

Geography: Iran is a large nation with varied geography. The Elbruz and Zagros mountain ranges run from the northwest corner (where Iran touches Turkey and the Soviet trans-Caucasus) diagonally southeast, along the border with Iraq, and then parallel to the Persian Gulf. South of these mountains, at the head of the Gulf, are Iran's oilfields. North of the mountains the nation is divided into two regions. The western part, near Iraq, Turkey, and trans-Caucasus Russia, is fertile, heavily populated, and includes most of the major cities and industrial plants. The eastern part, bordering Pakistan, Afghanistan, and Soviet Central Asia, is mostly barren deserts and mountains with a small, impoverished, undereducated population.

Level of Conflict

Cold War: Iran's use of terrorism has been very effective to date. America's confused policy response, culminating in the Iran-Contra scandal, is one example. However, eventually the continued violence may provoke a military response from the Western nations.

Limited War: Iran and Iraq have been fighting a limited war since 1980. The cities of Abadan and Basra, on the national border where the Tigris-Euphrates rivers empty into the Gulf, are largely ruined by the fighting. Running northward are two opposing lines of trenches and bunkers with a "no-man's land" between.

Each side attempted to discourage Persian Gulf shipping from aiding the opposition, resulting in missile and rocket attacks on many freighters and tankers. In 1987 and 1988 American fleet units escorting oil tankers became involved in surface battles with Iranian ships and boats, as well as an

unfortunate civilian airliner that flew through a battle area and was shot down by the somewhat inept crew of the missile cruiser USS Vincennes.

Conventional War: Russia could invade Iran as part of a wider NATO-Warsaw Pact conflict, or as a counter to the Shi'ite radicals, who would like to spread their revolution to the USSR's Moslem population. America may be drawn into invading Iran by its confused foreign policy. The vast and often hostile geography, not to mention a large and hostile population, argue against traditional military invasions. Instead, a gradual escalation from limited war, including bigger and deeper air attacks, is more probable.

America's strongest allies in the Persian Gulf are Saudi Arabia and the tiny island kingdom of Bahrain.

CV Nimitz at Sea (KY83): This huge 80,000-ton nuclear carrier is the class ship of the latest and most powerful program of aircraft carriers. Normally assigned to the Pacific Fleet, it is prepared to visit the Indian Ocean at any time. Here it sails with a close escort of destroyers, and has its F-18s on regular rotation in CAP (combat air patrol).

American aircraft carriers do not sail into the restricted waters of the Persian Gulf, where they would be "sitting ducks" for land-based air and missile attacks. Carrier task forces remain in the Indian Ocean, although the Nimitz and her ring of close escorts have sailed deep into the Gulf of Oman, to provide a base as close as possible to Persian Gulf targets. If threatened the ship can always sail to the southeast and escape into the vast expanses of the Indian Ocean.

Ras as Saffaniyah (JY19): This is Saudi Arabia's northernmost oil terminal and port along the Gulf. Its airfield is in a useful strategic location. Basing privileges for a secret "stealth" mission can be arranged with the pro-American Saudi monarchy.

Dhahram (JY54) & Al Hufuf (JY44): Dhahram is Saudi Arabia's largest port city on the Persian Gulf, making its airfield an unwise choice for stealth aircraft operations. However, the Al Hufuf airfield slightly inland is a strategically useful and less public position for basing missions and raids. Either can be used for stealth missions, although Al Hufuf is preferable.

As Salamiyah (JY00): This small airbase outside of the capital Riyadh is a nice, quiet location where clandestine missions can be organized easily. Unfortunately, the gulf coast is far away.

Bahrain (JY65): This small island nation is strongly pro-American, providing large naval and air base facilities for American military forces. It is fairly easy to operate stealth missions from here.

Kuwait is a friendly neutral nation, Oman is neutral but pro-Western, and the UAE are studiously neutral.

Kuwait City in Kuwait (JZ12): Originally neutral, Iranian threats and attacks caused Kuwait to seek US military aid and support. The Kuwait airport can be used to occasionally stage missions that demonstrate America's sup-

Friendly Bases

Neutral Bases

port to Kuwait, or for emergency landings. However, Kuwait is fearful of provoking more Iranian hostility, and therefore will not grant America basing rights. Besides, they'd like to stay on the good side of the Soviet Union too!

Kuwait's great oil fields are south of the city, in ONC JZ20 and JZ30.

Qatar (JY75): This small independent nation works hard at the appearance of neutrality, probably because it has strong pro-American and strong pro-Iranian factions. Although missions cannot be staged regularly from here, it is possible to use the pro-American groups to aid in specific clandestine missions or emergency landing situations.

Ruweiss (KY01) & Tarif (KY11): These small oil ports of the United Arab Emirates are not especially friendly to the American cause. Because the UAE is a decentralized government, pressure and money in the right places could permit a clandestine mission or emergency landing.

Some of the largest oil fields of the UAE are in this area (ONC KY22-23).

Abu Dhabi (KY31): Abu Dhabi is the major city of the United Arab Emirates (UAE), where the appearance of neutrality is most important. Staging missions or emergency landings from this base is very difficult, but not impossible if Iranian diplomacy succeeds in making yet more enemies.

Al Khafi at Dubai (KY65): This large airfield, outside the city of Dubai, is the most strategically useful of all UAE airfields. It is the base closest to south-central Iran, and as such an important launching or retrieval point for deep missions. However, as at Abu Dhabi, political problems make the use of this base difficult to impossible.

Muscat in Oman (KY90): Oman is careful to remain neutral in all affairs, but is strongly pro-Western. For example, much of its army is trained and officered by "retired" British military personnel. The military portion of the Muscat airfield is available for missions and emergency landings, provided everything remains secret and politically "deniable"

The Sights in the Persian Gulf

The Persian Gulf is a desert region, not unlike Libya, except for the large, high spine of mountains that runs diagonally through Iran from the northwest to the southeast. However, water is more plentiful, especially in Iran, resulting in increased agriculture and a large number of local irrigation works to control the seasonal run-off from the mountain highlands.

The Gulf has many interesting and exceptional areas, such as the Tigris-Euphrates watershed that reaches the head of the gulf around Abadan. Once a great seaport and teeming metropolis, the destruction of the Iran-Iraq war has reduced the area to a ruin of small towns and villages.

Kharg Island, despite wartime attacks, remains one of the great wonders of the world. Surrounded by oil platforms and supertankers, guarded by missile boats and fighter patrols, it remains the site of numerous refineries and oil storage tanks. There are also great oilfields south of Kuwait City, north of Bushehr in the Bandar-e-Rig, on Bahrain and Qatar, and along the UAE coastline near Ruweiss and Tarif, as well as assorted individual platforms

along the Arabian Gulf coast.

Another interesting region of Iran is the great valley of Bandar-e Lengeh and Bandar' Abbas. Seasonal rivers, flowing from the mountains, have formed a fertile valley floor that empties into the Straits of Hormuz, the strategic doorway to the Persian Gulf. On the opposite side (the southern side) of the straits, the mountainous peninsula of Musandam knives into the straits, creating a narrow choke-point of naval traffic.

Upper Khuzestan Triangle - Dezful (JZ38), Masjed Soleyman **Iran**

(JZ47), Ahvaz (JZ37): These cities are the main "rear areas" behind the Iraq-Iran battlefield. They have a variety of SAMs. Although all originally had airbase facilities, it is believed that only Masjed Soleyman's is still intact.

Abadan (JZ24): This city is located at the final junction of the Tigris and Euphrates Rivers, just before they empty into the Persian Gulf. Numerous battles in and around this area have destroyed a large part of the city. The surrounding countryside, once contained with dikes and irrigation projects, is now reverting to a poisonous marshland in the aftermath of heavy fighting, which included the use of poison gas.

Bandar Khomeyni (JZ44): This is the main Iranian military base behind the southern part of the Iran-Iraq front, and a major staging base for military supplies and munitions of all sorts. It has a large airbase, powerful SAM batteries, and a major military headquarters.

Bandar-e-Rig Oil Fields: These oil fields, clustered along the coast and inland hills (JZ61 and JZ71) are a key source of Iran's oil wealth.

Kharg Island (JZ60): This island is covered with refineries, oil storage tanks, and port facilities for oil tankers. Until the Iran-Iraq war it was the greatest oil terminal in the world. Repeated attacks have ruined many of the facilities, but never all of them. Now protected by SAM batteries, and missile boat patrols, it is still Iran's main port for oil export.

Much of Iran's oil wealth is slightly offshore. One of the heaviest concentrations of oil platforms exists in this vicinity of Kharg Island. Beware that some platforms are now used by Iranian Shi'ite "Guards" as military bases.

Bushehr (JZ80): This important coastal city was once a major oil port, but is now completely overshadowed by neighboring Kharg Island. The military forces on its airbase, and the SAM batteries, are not always first rate. However, it is home port for many Iranian frigates and missile boats that patrol the gulf.

Shiraz (KZ03): This inland city, sited on a highland plateau, is one of the largest Iranian cities. It is also the nerve center and main headquarters for Iran's southern military command — the forces responsible for the Persian Gulf. There is an exceptionally large military airbase here, and it is usually protected by a powerful SAM battery.

Esfahan (JZ89): This inland city, nestled in a large col of the Zagros Mountains, is the classic "gateway" to northwestern Iran. As a transportation and population center it naturally boasts an airfield, and SAM sites protecting

it. The current state of the Iran-Iraq war has a powerful effect on what sorts of aircraft are based here.

Yazd (KZ38) and Kerman (KZ84): These two cities are distant population centers on the edge of the Iranian deserts. Both cities are dominated by a strong traditionalist sentiment, which in recent years has translated into fervent Shi'ite extremism. However, the huge war losses are causing many families to reconsider their support for the Jihad.

Bandar-e Lengeh (KY57): This western city on the Straits of Hormuz has a minor military base, including an airfield and SAM battery. However, its primary function is civilian, serving the large oil fields in this area.

Seasonal rivers running from the mountains to the west down into Bandar-e Lengeh have a variety of interesting road and rail bridges over them.

Offshore Oil Platforms are especially common in KY35-45.

Bandar 'Abbas (KY68): This city is Iran's major military base on the Straits of Hormuz. Major Iranian Navy elements are based here, as well as the latest SAMs and a large, well equipped military airbase.

Secret Bases: Western intelligence operatives in Iran are preparing two secret, hard-pack surfaces suitable for aircraft landings. One is in the Shalamzar valley (JZ67) in the Zagros Mountains, the other in the mountains south of Kerman, at KZ82.

Air Defenses

HAWK batteries are Iran's longest ranged surface-to-air missiles. Nearly exhausted in fighting with Iraq, these weapons are formidable defenders of Iran once more. The reason? A large shipment of parts and spare missiles by Lt. Colonel Oliver North, USMC. He hoped to trade them for American hostages in Lebanon. Iran got the missiles, the hostages remained in Lebanon, and North resigned from the Marines Corps. Think about that when one fires at you!

Rapier batteries, sold by Britain to Iran, are fast, but shorter ranged, and hindered by a fire control system that is primarily visual, with the radar intended originally as backup. The Rapier radar system never approached the quality or sophistication of the HAWK. In fact, in the Falkland Islands fighting, the Rapier was surprisingly ineffective.

The Tigercat, an antiquated British design, appears in less-important areas. Many Tigercat sites have little or no radar, since the missile is designed for visual control. The Seacat is a naval version of the Tigercat, found on Iranian Vosper Mk 5 type frigates. It is somewhat more dangerous because the frigates have decent radar search systems.

Iranian Air Force

This service arm is composed primarily of American-built aircraft acquired during the Shah's rule. Before the outbreak of the Iran-Iraq war the Air Force had a nominal strength of 75 F-14 Tomcats, about 200 F-4D and F-4E Phantom IIs, 140 F-5E Tiger IIs, plus various other planes and helicopters, including C-130 Hercules transports and P-3F Orion reconnaissance bombers.

Fighters: Iran lacks the sophisticated technicians and parts to keep its F-14s operational. Within a year after the revolution fewer than five were

functional. No missiles or parts exist for the long-range Phoenix AAM system, but some F-14s still have functional long-range radars. F-14s can carry AIM-7F Sparrows or AIMN-9H Sidewinders.

The older but less effective F-4s and F-5s are easier to maintain. These planes are the backbone of the Iranian fighting air force, intercepting Iraqi raids, guarding rear areas and ships from attack, and occasionally attempting a raid into Iraqi territory.

Iranian fighters are equipped with AIM-9H Sidewinders, one of the last and best first-generation IR AAMs. The F-4 Phantoms (but not the F-5 Tigers) are designed to carry the AIM-7F Sparrow, a long range radar-homing missile.

Reconnaissance Bombers: Iran has few naval reconnaissance bombers, and most of those are P-3C Orions with inoperative electronic gear. Such planes are reduced to making visual patrols only — a waste of aviation fuel in a modern warfare environment!

However, it's possible that long-range Russian Tu-95 "Bear" bombers may make an appearance, flying from Afghanistan or Yemen.

Airborne Early Warning & Control: Iran has no "AWACS" or other AEW&C aircraft. Instead, the few operational F-14s are used in this role, since the F-14 has an extremely powerful air search radar.

Air Transports: Iran has a variety of small, medium and large air transports, including the American C-130 Hercules, German Fokker F.27, French Dassault-Breguet Falcon 20, and Boeing 707 and 747 transport models. The exact types available vary greatly, depending on the supply of spare parts and the presence of knowledgeable mechanics. Given Iran's dislike of the West, some consider it likely that she will shop in Russia for the next transports bought, perhaps the new and very flexible An-72 Coaler.

The Iranian Navy has suffered greatly in the Iran-Iraq war, since most resources go into the army and air force. Many ships were damaged in the fighting and remain unrepaired; others have deteriorated badly for lack of maintenance. The great naval base at Khorramshahr, near Abadan, was destroyed early in the war and remains a ruin in no-man's land.

It is believed that one or more of the four Vosper Mark 5 frigates are still functional. These 1,100-ton ships include a Seacat SAM surface-to-air missiles, and a 4.5" gun turret. Occasional patrols by these or smaller ships can be expected in the region of Kharg Island or in the Straits of Hormuz. If functional, the Vosper frigates pose a significant military threat.

Iran's Shi'ite "Guards" also man a large number of fast motorboats. The crew carry rocket-propelled grenades to attack shipping, and shoulder-launched IR SAMs to protect themselves from air and helicopter attack. Virtually invisible, these "mosquitos" are a threat only to unarmed merchant shipping, or an aircraft unlucky enough to pass over the area. These boats are based all along the Iranian coast, especially at Bandar 'Abbas, and from a variety of offshore oil platforms.

Navy

The North Cape

Introduction

Politics: The North Cape area is shared by four nations. West to east, they are Norway, Sweden, Finland, and the Soviet Union. Their political orientations parallel their geographic locations: Norway belongs to NATO, Sweden is a pro-Western neutral, neutral Finland accommodates the Soviets, and the Soviet Union, of course, leads the Eastern Bloc.

Military Forces: In terms of global politics, the North Cape is the single most important military region in the Soviet Union. Murmansk is Russia's only year-round open-sea access to the Atlantic ocean. Russian SSBNs (ballistic missile nuclear submarines), the heart of nuclear deterrence, sail from here into the Atlantic and Arctic oceans. The Soviet Northern Fleet protects these invaluable weapons, as well as maintaining a credible threat to NATO's Atlantic lifelines.

Norway fields a large, tough force tailored for a dogged defense of its mountainous homeland. Reasonably well-equipped, the majority of the forces guard the populous southern regions. The northern bases have only token garrisons. Northern Norway seems more important to NATO than it is to the Norwegians, since important NATO air, naval and marine troop assets are plan to reinforce this area in time of war.

Sweden's armed forces are designed to make the Russians (or anyone) think twice about violating that country's neutrality. The forces are well equipped and well trained, with a nationwide reserve system that makes a large part of the citizenry part-time soldiers. However, the northern part of Sweden is almost unpopulated, so the defenses there are considerably lighter.

Recently Sweden has been greatly irritated by Russian midget submarines literally crawling around inside her fleet bases, and by a Russian diesel sub that ran aground in a harbor entrance while carrying a nuclear-tipped torpedo (a serious insult to anti-nuclear Sweden). As a result, Sweden may be willing to support NATO clandestine operations as a form of revenge.

Finland fields a much smaller and less sophisticated force than its neighbors. Although fiercely independent, Finland has learned to accommodate the desires of its powerful neighbor, the Soviet Union. The Soviets maintain this "friendly" attitude by garrisoning powerful military forces near the Finnish border, and strongly encouraging Finland to buy Soviet military equipment. So even if Finland could detect F-19 overflights in its northern regions, it's unclear whether it would bother informing its "friend" Russia immediately.

Geography: This entire region is a harshly cold climate. Northern Norway is a long, mountainous country with a harsh climate and "iron" (rocky) sea-coast. In this terrain a small group of determined defenders could stop an army for years. The "open" areas of Finland and Sweden are deceptive. On the map it may appear to be an open plain, perfect for attack. In reality it's a frigid wilderness in the winter and a vast, marshy bog in the summer.

Cold War: Because of the potential threat posed by the Northern Fleet's ships and aircraft to the shipping lanes in the Atlantic, NATO and Russian forces are constantly sparring with each other, testing the other's responses and jockeying for position should hostilities break out. Officially at peace, the two sides wage a covert conflict of intelligence gathering and military posturing that can turn deadly at any instant.

Limited War: If Russian or American foreign policy was conducted with greater hostility, the North Cape would make an ideal place for Western raids or retaliations against the Soviets. Similarly, their air and sea defenses could get excessively "trigger happy" and shoot before asking questions. Even among men of good faith, there is always a temptation to send in a secret mission to "take out" something that really bothers you. Israel and South Africa, for example, have surrendered to this temptation from time to time.

Conventional War: The balloon's gone up. NATO and the Warsaw Pact are officially shooting at each other in this part of Europe (perhaps elsewhere too). The Northern Fleet is making a sortie into the Atlantic, Soviet troops have crossed the border into Norway, Mainstays and MiGs are clouding the skies. Now missions are no joke at all. Getting in and out with your skin intact will be very, very tricky!

The two Norwegian land bases here are civilian airfields, but both are closer to the Russian border than the NATO bases at Banak and Bardu. It is easy and wise to stage stealth missions through either Lakselv or Kautokeino, rather than flying longer distances from more rearward fields. Such staging could be just a quick landing and refueling both inbound and outbound. In effect, the fields can function as grounded refueling tankers.

Kautokeino (WX11): Located in the barren tundra of the Finnmarksvidda, Kautokeino airfield is well suited for operations across the top of Finland to Murmansk. The population is very small and the entire area well defended by tundra swamps and bogs in the summer, or sub-zero blizzards in the winter.

Lakselv (WX34): Located at the inland end of the Porsangen Fjord, Lakselv town has an airfield ideally suited to operations into Russia. It is far enough from the border to survive the first few days of fighting, but close enough for easy flying.

CV Kennedy at Sea (WX67): In the middle 1980s the Secretary of the Navy announced a new policy — a wartime policy of sending aircraft carriers deep into the Norwegian Sea, to challenge Russia's fleet near its home ports. Although considered suicidal by some, this policy is certainly useful for launching stealth missions. Here CV67, one of the conventional carriers with the US Atlantic Fleet, makes a quick dash to the North Cape to launch your mission. As always, the carrier is accompanied by a screen of escorts, and is constantly launching and recovering a CAP of F-18s.

Available neutral bases in this region are all Swedish. Sweden is strictly neutral in international politics, but economically closely tied to the Western

Level of Conflict

Friendly Bases

Neutral Bases

bloc. Given recent events and aggressive Russia moves, it's not unlikely that a few clandestine stealth missions, or emergency landings, would be allowed at northern Swedish airbases.

Kiruna (WW28): The northernmost airfield in Sweden, this base is located in the nearly unpopulated foothills of the Esrange Mountains. Stealth missions could operate easily from this area, with nobody but reindeer to observe the events.

Gällivare (WW26): Although this airfield is also far north in Sweden, Gällivare town is a junction of rails and roads. In the summer months it is also a popular tourist area, with the Muddus National Park a few miles to the west. Stealth missions operating from this base must be very discreet.

Luleå (WW13): This fairly populous city is the main Swedish military base in the Northern Region. It is also a port on the Gulf of Bothnia, the northernmost arm of the Baltic Sea.

The Land of the Midnight Sun

The North Cape (Nordkapp in Norwegian) is a realm of extremes. In summer the sun shines throughout the night, while in winter it never rises above the horizon.

The most northerly areas are realms of tundra and permafrost — ground that remains frozen throughout the year, save for the top few inches in the summer. Only moss and coarse grass grows here, although it can turn brilliant green on good summer days.

The majority of the region is taiga, vast pine forests that are home to reindeer, arctic fox, and rock ptarmigan. The southerly lowlands are a deep watershed, full of small lakes, marshes and bogs. The White Sea coastline is almost entirely marsh as the land blends gradually into sea.

The interior of the Kola Peninsula has the characteristic mountains of a tundra-taiga borderland: low, rolling, rocky and bare, with pockets of snow even in summer. The Norwegian coast has more dramatic terrain. Here is the topmost end of the spine of mountains that divides Norway from Sweden. Even here they are still steep, bare rock with clinging patches of ice and snow.

Amid this monotonous, desolate terrain are impressive human works, especially the city of Murmansk with its sprawling military complexes. Hideously expensive to build and maintain through the long, deep winter, this region is surely the most valuable military real estate in the world, judging by money invested per acre!

Northwestern Russia

Murmansk (XX11): This major city is Russia's only year-round port on the Atlantic Ocean. Its great piers and depots support not only a steady stream of merchant shipping, but the powerful Red Banner Northern Fleet. Murmansk is literally "at the end of the line", in this case a long railway line that runs southward 700 miles to Leningrad.

Murmansk is also the nerve center of Russia's powerful air forces, including both PVO air defense planes and Naval Aviation of the Northern Fleet. Satellite airfields surround the city, including large bases at Kildenstroy (XX10) and

Kilpyaur (XX00). The Northern Fleet includes, roughly, one aircraft carrier, 75 other major surface warships, one marine brigade, 133 submarines, and 446 naval aircraft. The protection of its bases is the duty of 12 Divisions of army troops (about 300,000 men total) and 150 planes of Tactical Aviation (air force planes supporting the army) and the PVO (air force interceptors guarding the border).

The great Severomorsk (XX31) submarine pens are also just outside of Murmansk. This underground base is the home port for the new Typhoon class of ballistic missile subs, as well as many other diesel and nuclear undersea craft.

Pechenga (WX91): This town is Russia's forwardmost military base in the far north. Just a few miles from the Norwegian border, Pechenga is the inevitable staging point for any invasion into NATO territory. Although it has an airbase and strong SAM defenses, the Polyarnyy airbase complex to the east (in WX80) is somewhat larger.

Monchegorsk (XW18) & Olenegorsk (XW19): These two towns, near the base of the Kola peninsula, are major airbases for long-range naval aviation bombers, as well as providing fighter and SAM cover to the railroad link between Murmansk and the south.

Kandalaksha (XW16): This small city is the main population center at the base of the Kola peninsula. It is primarily a transportation hub, with rail lines and a naval port the faces eastward, into the White Sea.

South of the city lies the Loukhi (XW04) air defense complex, including a large SAM battery that covers this section of the Murmansk-Leningrad rail line.

Kem (XW21): South of Kandalaksha, Kem is the next significant city along the Murmansk-Leningrad line. It too is a small port facing onto the White Sea. It is also the starting point for the Voknavolok rail line that runs westward to the Finnish border. This is a purely military line, intended to support the Russia military presence on the Finnish border.

Arkhangel'sk (XW71): This city is Russia's largest port on the Atlantic. Although closed by ice during the winter, it has much better rail and road connections to the interior of Russia, and is almost totally invulnerable to enemy attack. In addition to large port facilities, the city is surrounded by military defenses, the most notable being the complexes at Severodvinsk (XW51) and Kushkushara (XW84). In addition, units of the Northern Fleet patrol offshore in the White Sea.

Secret Bases: Western intelligence operatives in this area have secret created two hard-frozen airstrips suitable for landings, one at XW57, the other at XX20.

The Kola Peninsula is vital to the Soviet Union because of the access it affords to NATO's lines of communications, but its very proximity also makes it particularly vulnerable to NATO counterstrokes. Consequently, the Kola

Air Defenses

Peninsula is likely to prove one of the most challenging anti-aircraft environments in the world today.

In clandestine missions it may prove impossible to penetrate and escape this area without eliminating at least one radar system. However, you may get lucky — the systems often shut down for varying periods of time due to maintenance difficulties in this most rigorous of climates.

Long Range SAMs: These are area defense weapons that, along with fighters, are your primary opposition. The older SA-2s and SA-5s have been undergoing continual upgrade to SA-10 and SA-12 quality. The entire system is enhanced by the LPAR early warning radar system at Kirovsk.

Light SAMs: Soviet ground forces in this area are outfitted with the usual battlefield SAMs, including the older SA-9 and SA-13 IR missiles, as well as the newer SA-8 and SA-11 radar guided missiles. Mobile infantry carrying SA-7 and SA-14 shoulder-launched IR SAMs are a significant threat as well. Check out your intelligence briefing (preflight) for “special event” areas showing the latest enemy troop concentrations.

The PVO and Naval Aviation

Fighters: This region is defend partly by the PVO units, with long-range MiG-25 and MiG-31 interceptors using long-range radar-homing AAMs. Naval aviation fighters operating from either carriers or land strips include the Yak-38 V/STOL jet and the new Su-27 multi-purpose fighter. During wartime shorter-ranged units may arrive, including MiG-29 and Su-27 dogfighters with short-range IR missiles as well as long-range radar weapons.

All these planes but the Yak-38 are worthy opponents. The Yak can only carry IR homing missiles (generally AA-8 Aphids). It is considerably slower and less flexible than the other fighters.

Reconnaissance Bombers: Many long-range Tu-95D “Bears” are based in this area, to keep tabs on NATO naval activity in the North Atlantic. A nuisance in peacetime, these planes pose a serious threat in a war. Eliminating them is always a high priority in NATO war plans. That would blind the Russian high command to activities in the Atlantic and Norwegian seas.

Transports: Russia possesses numerous air transports for its huge force of airborne units. The most modern of these is the jet propelled An-72 “Coaler,” which is particularly suited to fast, high priority missions like inserting commando teams or transporting critical command personnel.

AEW&C Aircraft: The Soviets routinely deploy Il-76 “Mainstay” aircraft in this region. The 300+ mile radars on this plane may be your most formidable enemy. If you’re spotted and can’t discover how or by whom, chances are it’s a Mainstay.

The Red Banner Northern

Russia’s Northern Fleet offers both tempting targets and a significant threat. Its modern Sovremenny-class destroyers carry SA-N-7 missiles, while the numerous Krivak class frigates sport the SA-N-4. The larger Kiev-class carrier has the powerful SA-N-6, a sea-going equivalent to the SA-10. These warships are more than capable of defending themselves. Stationed off the

northern coast, they significantly extend the Soviet anti-aircraft umbrella.

In addition to these ships' SAMs, the Kiev carries a complement of Yak-38 "jump-jet" fighter aircraft. While less capable than ground-based fighters, the British Harriers in the Falklands taught the world not to underestimate the capabilities of such planes.

An upcoming addition to the northern fleet is a class of huge aircraft carriers fitting out in the Crimea. Tentatively titled the "Kremlin" class, these ships are expected to join the Northern Fleet soon.

Central Europe

Introduction

Politics: Central Europe is where the full force of East and West meet. Since World War II Europe has been two hostile blocs, with a few neutrals balanced between. On one side are the communist East European nations, created in the wake of Soviet armies at the end of WWII. On the other side are democratic Western European nations, created by the USA and Britain in the wake of *their* armies during WWII. Since 1949 the West has been linked by NATO. In 1955 the East formalized an equivalent organization, the Warsaw Pact, dominated by the USSR. From then to now the two greatest military organizations on earth have uneasily eyed each other along the German border.

Military Forces: The Warsaw Pact can deploy almost three million men, about 80,000 armored fighting vehicles, and 6,000 combat aircraft. Against this juggernaut, the Western powers can field around two million men, 40,000 AFV's, and 4,000 combat aircraft. The numerical imbalance is partially offset by the higher quality of the Western troops and equipment, presumably along with the traditional advantages of being the defender.

Together, the two sides have almost ten thousand nuclear weapons for battlefield use in Europe. These range from small, sub-kiloton shells designed to wipe out troop concentrations, up to multi-megaton city busters. Artillery, planes, and missiles of all types and ranges can deliver these weapons. At one time NATO felt it had to use nuclear weapons to compensate for numerical inferiority. Today it has an alternative plan: "Air-land battle, 2000." In this NATO uses superior technology, including its stealth planes, to attack deep in the rear of the Warsaw Pact armies, destroying their logistical support. If this innovative strategy works NATO need not use nuclear weapons to stem the Red tide. However, if this fails, NATO must choose between a nuclear holocaust and the conquest of Europe by the Soviet Union.

Geography: The "Central Front" stretches 1000 kilometers through the middle of Germany, bordered on the north by the Baltic Sea, and on the south by the Alps. The initial strategic objective of a Russian invasion would almost certainly be the Rhine river, only 150 kilometers from the frontier (at the closest point). West German terrain is mildly favorable to the defender, especially in the forested and hilly southern half. The broad, flat North German Plain is the traditional invasion route. But every few kilometers there is a new town, village or city. Each could become a new defensive bastion.

One often neglected geographic consideration is the terrain to the *east* of the frontier. With the development of the "Air-land battle" this region takes on a new significance. The North German plain broadens toward the east, encompassing most of East Germany and Poland. It is crossed by a number of major rivers flowing northward, channeling road and rail traffic into a variety of bridges. This combination of open countryside and numerous "choke points" is well suited to air operations.

Cold War: This is the situation of the last 40 years. The two sides maintain a wary posture, generally trying to avoid overt provocations, probing each other to gain information, stir discontent in the enemy population, and gain psychological advantages. The stealth fighter, designed for clandestine penetration, is the perfect aircraft for the secret operations common in this situation.

Limited War: Now the conflict is at the brink of open warfare, but armies have not yet crossed any borders. As military acts escalate, the opportunity for stealth missions increases as well. Military actions are political signals that urge the other to back away in forceful terms. Unfortunately, sometimes fighting just escalates. This technique was successful for America on Grenada and against Libya, but it failed in Vietnam. Well, you're just a stealth pilot, carrying out orders.

Conventional War: This is it! Russian tanks pour over the West German border while NATO forces scramble to stem the onrushing tide. On one side lies conventional defeat, on the other the disaster of thermonuclear war. "Air-land battle, 2000" goes into effect. Stealth aircraft, airmobile raiding groups, and long range "smart" munitions make the dangerous crossing over the front to hammer Soviet rear echelons. If they can isolate the Russian spearheads from their base, they may give the politicians an opportunity to avert disaster.

West Germany, Holland, and Denmark are studded with airfields that could serve as bases for stealth raids into Eastern Europe. They form a gentle, north-south crescent bulging west in the middle. Which is the most suitable starting point for a particular airstrike depends mainly on the location of the target. However, the stealth fighter's unique characteristics will be most effective in the areas only thinly covered by radar to the north and south of the main arena. Therefore, deep penetration raids will usually start from Denmark or Southern Germany. Shorter tactical strikes, however, must fly directly into the mouth of the tiger.

Jutland Peninsula - Vandel (CC52) & Leck (CB59): These far northern bases make ideal jump-off points for raids out across the Baltic. Often it's easier to deal with missile boats in the Baltic than the heavier SAM defenses in East Germany and Poland.

Northern Germany (Hanover) - Ahlhorn (CB37) & Gutersloh (CB53): These bases, directly behind BAOR (British Army Of the Rhine), face across the flat, densely populated North German Plain, the most likely axis of advance should the Warsaw Pact attack NATO. Therefore, they represent the most direct route to one of the greatest concentrations of hostiles in the world.

Central Germany (Westphalia) - Rhein-Main (CB52) & Ramstein (CB50): These bases are the great, famous bases of American air power in Europe. Rhein-Main is one of the largest military bases in the world, while Ramstein is headquarters for the 4th Tactical Air Force.

Southern Germany (Bavaria) - Neuberg (CA68), Leipheim (CA57) & Memmingen (CA65): These bases are all Luftwaffe (air force of the

Level of Conflict

Friendly Bases

Federal Republic of Germany), but like many German bases, are entirely willing to host American aircraft as needed. Any of these bases makes an excellent jump-off point for missions into Czechoslovakia.

Sightseeing from the Baltic to Bohemia

Without doubt, the most impressive sights in this region are the vast urban metroplexes, from the northern ports of Hamburg (CB67) and Lubeck (CB77) to the old cities of Leipzig (CB82) or Warsaw (DB95), or the industrial sprawl of Prague (DB30) and Krakow (DB90). Those northern areas not covered with cities, towns or villages are divided into small plots of farmland. Much of the area is watered by extensive river systems flowing northward. Bridges large and small are common near cities. An especially impressive suspension bridge can be found on the southwestern outskirts of Hamburg (CB67). The southern part of this region is dominated by low mountains that virtually surround the Czechoslovakian lowlands of Bohemia (to the west) and Moravia (to the east). The valleys and passes amid the mountains provide numerous natural routes, and not a few flying challenges. Although much of the highland areas were once forested, in the last few decades acid rain has denuded many areas and started rampant erosion. The once green mountains are now more frequently brown, gray, and black. The much higher Alps, capped by perpetual snow, are generally obscured by haze to the southwest.

The Eastern Bloc

East Germany: During a limited or conventional war the main strength of the Warsaw Pact forces will travel through here, surging into West Germany. The greatest natural barrier in East Germany is the Elbe River, running from the Czechoslovakian mountains northward to Hamburg. Destroying these river bridges would cut off the Pact's forward troops from their supply lines.

Covering the Pact's forward areas are two main air defense complexes, one in the north near Wittstock (CB97) and Wittenburg (CB87), another in the south just east of Leipzig and Magdeburg, including the big radars at Mittenwalde (CB93) and Grossenheim (CB92).

Poland: In a NATO-Pact conflict Poland is the "rear area" through which Russian troops and supplies would flow toward the front lines. Many important headquarters and depots are situated in the central and western part of the nation. The Wista-Vistula river system divides Poland in half, from north to south. Destroying the road and rail bridges can seriously damage Pact operations. Polish defense complexes include a powerful system west of Gdansk at Stupsk (DB48), and south of Lodz at Radom (DB83). In addition, Warsaw (DB95) is a major transportation hub, so active SAM batteries can be expected in that area during wartime.

Czechoslovakia: This Pact nation, separated from Germany by the mountains and the rugged highlands of the Bohemian Forest, is likely to play a secondary role in wartime. Czechoslovakian defenses are also somewhat lighter than those of East Germany and Poland. Tabor (DA38) is the most significant installation. Far to the east, guarding the entrance to Hungary and southern Poland, is another defense complex at Konmarno (DA87).

Kaliningrad: This region of Russia, named after the major seaport of Kaliningrad (renamed from Königsberg in 1945) at DB89, is the Soviet "front line" on the Baltic. It includes a major OTH (over-the-horizon) radar station at EB09, as well as the Klaipeda airbase (EC02).

Equipment: Since the "Central Front" forms the focal point of the war, the anti-aircraft defenses on both sides are the most intensive in the world. The Soviets are certain to deploy large quantities of their most modern weapons, SA-10s and SA-12s, for area defense. In some areas the older, less effective SA-5 long range systems may still be in place.

Radar guided SA-8s and SA-11s are most commonly used for more local defenses, especially near important military concentrations or objectives. A few are even sited near the larger SAM batteries to provide local defense. The shorter-ranged infrared SA-9s and especially SA-13s may appear instead if the radar-guided weapons are not available.

At sea the Baltic missile boats typically have either SA-N-5 or SA-N-7 systems, although Krivaks and larger ships with the SA-N-4 can be expected in wartime.

Defended Areas: The whole region is alive with lethal metal. The most dangerous areas will undoubtedly be on or near the front lines in West Germany, and perhaps at any invasion sites in Denmark. Also beware of reserve troop concentrations in East Germany or Poland. But these are relative assessments, not absolute. Let down your guard anywhere and your aircraft will undoubtedly follow.

The Soviet Air Force is the largest in the world, and one of the most modern. It deploys a wide variety of interceptor, bomber, and support aircraft. Some are obsolescent, but many can meet the best of the West. The Soviets know the value of air superiority. They'll give high priority to that goal in any European war.

Fighters: As always, the primary foe is another pilot. With 6,000 combat aircraft to choose from, you can bet that the Red Air Force will find a few to spare for you. They'll also have the hot new models. If you're lucky, you'll only see second-line MiG-23s, but more likely you'll encounter quality dogfighters like the MiG-29 and Su-27. In the rear areas you're more likely to see long-range interceptors like the MiG-25 and MiG-31.

Bombers: The Russians have many different bomber aircraft. One of the most troublesome is the Tu-95 "Bear" modified to carry cruise missiles. Keeping a number of these craft in orbit deep behind Russian lines gives them an "untouchable" airborne nuclear force. Your job as an F-19 attacker is to prove that this nuclear weapon can be hurt too.

Airborne Early Warning & Control: The Soviet Il-76 "Mainstay" AEW&C was designed for work in this kind of environment. Flying "racetrack" orbits deep behind friendly lines, its powerful radars can see NATO air operations develop and radio appropriate orders to various fighter squadrons.

Air Defenses

Air Forces

The effort to develop these planes has been long and costly; the size, weight and expense of the electronic gear is gigantic. Each plane is precious. Eliminating them would cripple Soviet air operations. The Pact appreciates this too, so getting to them won't be an easy job.

Transports: Thousands of air transports will shuttle back and forth on both sides of the front line, carrying troops, raiding parties, munitions, staff officers, etc. The new Russian workhorse that flies anywhere and carries almost anything is the An-72 "Coaler". Its high speed and short-field capability make it the natural choice for secret missions, and a natural target for your stealth fighter.

Naval Forces

The Russian Baltic fleet, headquartered at Baltiysk outside of Kaliningrad, controls 4 cruisers, 16 destroyers (many of them obsolescent), 7 Krivak-class large frigates, 22 missile boats and other light warships, and 21 amphibious assault ships, as well as 45 submarines (mostly older diesel-electric models). It also controls the East German and Polish navies, which have numerous additional frigates and missile boats. This force has two goals: to cover the northern flank of the Warsaw Pact from air attack, and to invade Denmark in the event of war.

Stealth missions will generally deal with the former, your problem being how to penetrate the warship screen in the Baltic. Because of the many confusing classes of Russian, Polish and East German missile boats and frigates, it's always wise to check the data on a ship. The SA-N-5 is just a first generation IR homer, and no serious threat. The SA-N-4 uses older pulse radar guidance, but the new SA-N-7 is a more serious problem. Fortunately very few Baltic warships carry the powerful, long-ranged SA-N-10.

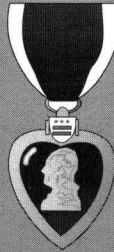

The Purple Heart

This medal is awarded to servicemen who are injured or killed as a result of an act by an opposing armed force. Typically the injury must be serious enough to require attention at a base hospital, often with reduced duties or discharge afterward.

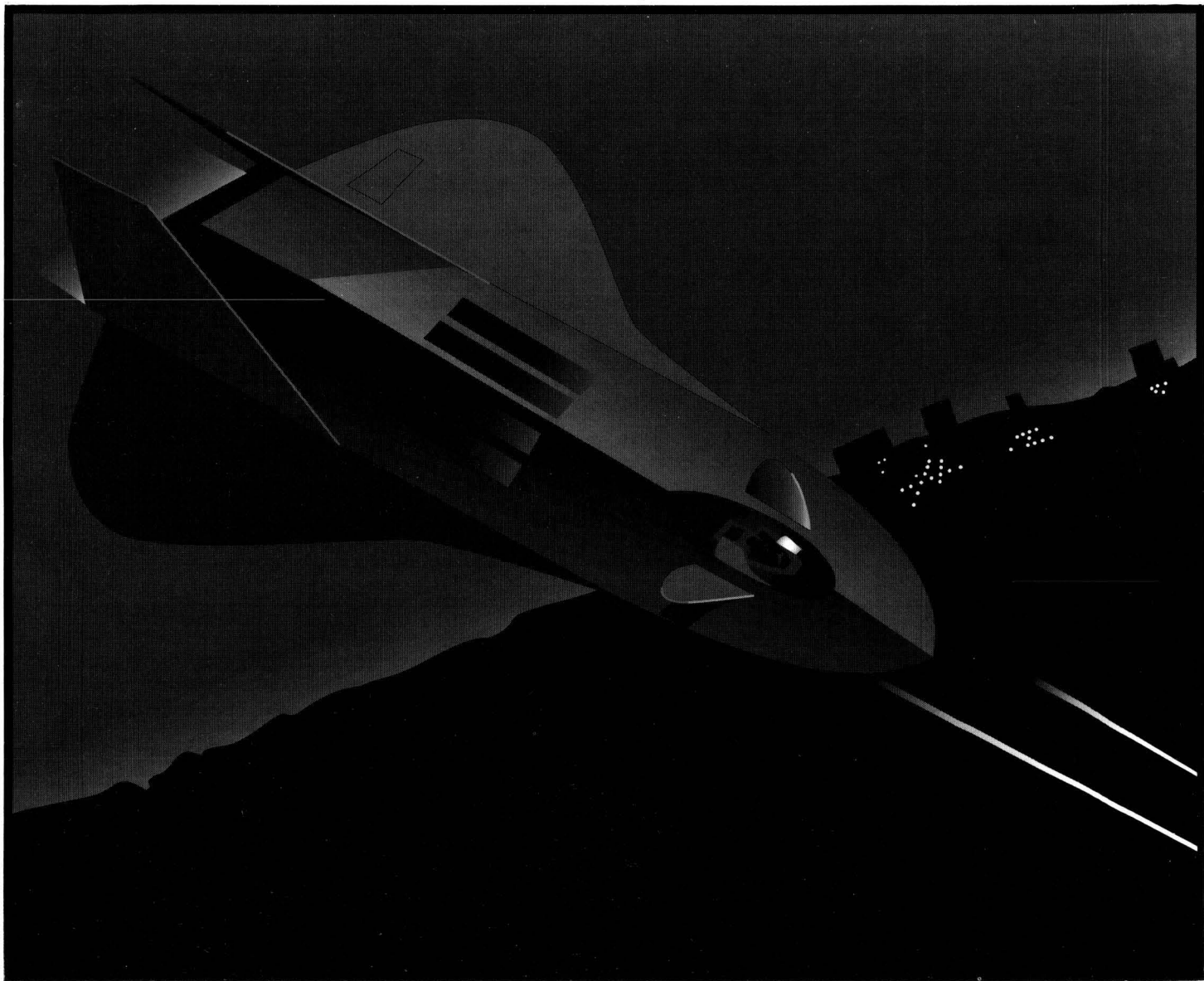

EQUIPMENT 5

The charts and tables on the following pages provide a detailed data reference for USAF ordnance available to the F-19. Also included is equivalent data on enemy aircraft weapons and SAM (Surface-to-Air Missile) systems.

Ordnance & Weapon Data Charts

USAF Ordnance Summary

Qty	Weapon	Max Range	Max Speed	Guidance System	Attack Altitude	Attack Techniques
-	M61A1 20mm Cannon	6 km	6000 kts	Historical sight	0' or more	anticipation firing
4	AIM-9M 'Sidewinder'	17 km	2000 kts	IR homing	500' or more	air-to-air fire & forget
3	AIM-120A AMRAAM	32 km	2400 kts	Radar homing	500' or more	air-to-air fire & forget
2	Penguin-3 ASM	32 km	500 kts	IR homing	500' or more	air-to-ship fire & forget
1	AGM-84A 'Harpoon'	60 km	500 kts	Radar homing	500' or more	air-to-ship fire & forget
1	AGM-88A HARM	20 km	1400 kts	Anti-radar	500' or more	air-to-ground fire & forget
2	AGM-65D 'Maverick'	32 km	700 kts	Thermal image	500' or more	air-to-ground fire & forget
2	GBU-12 Paveway	1+ km	glides	Laser homing	500' & climb	toss (or level) bombing
2	CBU-72 FAE	1+ km	glides	Laser homing	500' & climb	toss (or level) bombing
2	Mk 20 'Rockeye' II	1+ km	glides	Laser homing	500' & climb	toss (or level) bombing
2	Mk 20 'Rockeye'	0 km	retarded	none	over 500'	level bombing
2	Durandal	0 km	retarded	none	over 500'	level bombing
1	ISC B-1 minelets	0 km	retarded	none	over 500'	level bombing
3	Mk 82-1 'Snakeye'	0 km	retarded	none	over 500'	level bombing
2	Mk 35 IN cluster	0 km	retarded	none	over 500'	level bombing
3	Mk 82-0 'Slick'	0 km	free fall	none	over 3,000'	level (or dive) bombing
2	Mk 122 'Fireye'	0 km	free fall	none	over 3,000'	level (or dive) bombing
1	135mm/IR cameras	~10 km	on plane	fixed viewer	200' or more	level run
1	special equipment	0 km	retarded	none	500' or more	level run

Key to USAF Ordnance Summary

Qty: The number of weapons of this type you can carry in one of your bay positions (you have four weapons positions). The M61A1 cannon is fixed in the nose and always available.

Weapon: The name of the weapon

Max Range: The maximum range at which the weapon can be launched or fired effectively.

A 0 km range means the weapon is a free-fall or retarded bomb that must be dropped onto the target.

Max Speed: The speed at which the weapon reaches the target. This is given in knots so you can compare it with your own flight speed.

glides means the weapon 'flies' without power.

Therefore your speed, at the time of launch, becomes the speed of the weapon.

retarded means the weapon is a retarded bomb that falls away behind your craft, decelerating as it drops. Some retarded weapons even open a parachute during their descent, to stabilize the fall and line up the warhead(s).

free fall means the weapon is a traditional free-fall bomb that arcs downward to the target.

Guidance System: If the weapon has an on-board targeting system, it is mentioned here for general interest.

Attack Altitude: The recommended altitude for the typical attack method. The "500 and up" entry means any altitude above 500' is fine. The "500 & climb" means that a toss-bombing technique is used where the bomb is launched while the plane climbs from 500'.

Attack Techniques: This references the appropriate attack technique. Techniques noted in parenthesis are alternate attack methods that are either more dangerous or more difficult to learn. See "How to Fight" (pgs 56-61) and "Air-to-Ground Tactics" (pgs 78-80) for more details.

Key to USAF Ordnance, Effectiveness against Common Targets

Target Type Abbreviations

AC: aircraft in flight.

hgr: airbase hangar, which at military airfields are armored bunkers.

rwy: airbase runway.

plns: planes on airbase runways and aprons (i.e., outside of hangars).

twr: airbase tower, including the tower radars and radios.

nuc: nuclear power plant.

brg: bridge over a river.

blid: buildings, including terrorist camps, offices, warehouses, factories, villages, homes, etc.

bnk: bunker, such as fixed Army HQ sites.

dep: depot of military fuel and supplies

msl: missile launcher, including both fixed launchers and vehicles.

Launchers may have SAMs or SSMs.

sam: SAM radar station, usually with SAM missile launchers

lpar: Large-scale Phased Array Radar station

oth: Over The Horizon long-range radar station

plat: offshore oil platform

refr: oil refinery

tnks: oil storage tanks

wel: oil wells

Sub Pen: underground submarine pens

Ship: all ships, including cargo ships, warships, and surfaced submarines.

Results Abbreviations

The effectiveness of results is graded like a report card; the higher the grade, the more effective the weapon.

A+, A and A- means the weapons are especially effective against this target.

B+, B and B- means the weapons are of normal accuracy and effectiveness against this target.

C+, C and C- means the weapons are not very effective against this target, but may do damage if either you're skillful or lucky (or both).

D means the weapon has marginal effectiveness against this target. You have to be very skillful or very lucky to achieve an effective hit.

F means the weapon is totally useless against this target. Any attacks will be a complete waste of time and ordnance.

USAF Ordnance: Weapon Effectiveness against Common Targets

Weapon	AC	Airbases:				Struc:			Military:			Radars:			Oil:			Sub		
		hgr	rwy	plns	twr	nuc	brg	bld	bnk	dep	msl	sam	lpar	oth	plat	refr	tnks	wel	Pen	Ship
Cannon																				
M61A1 20mm Cannon	B	F	F	B	B	F	F	B	F	B	B	C-	C-	C-	B	B	B	B	F	C
Air-to-Air Missiles																				
AIM-9M 'Sidewinder'	A+	F	F	F	F	F	F	F	F	F	F	F	F	F	F	F	F	F	F	F
AIM-120A AMRAAM	A-	F	F	F	F	F	F	F	F	F	F	F	F	F	F	F	F	F	F	F
Air-to-Ship Missiles																				
Penguin-3 ASM	F	F	F	F	F	F	F	F	F	F	F	F	F	F	F	F	F	F	F	B
AGM-84A 'Harpoon'	F	F	F	F	F	F	F	F	F	F	F	F	F	F	F	F	F	F	F	A-
Air-to-Ground Missiles																				
AGM-88A HARM	F	F	F	F	F	F	F	F	F	F	F	A-	A-	A-	F	F	F	F	F	B+
AGM-65D 'Maverick'	F	C-	F	C-	C	B	B	C	B	C	C	B	B	B	B	B	B	B	F	B
Laser-guided Bombs																				
GBU-12 Paveway	F	B	D	C-	B	B+	B+	B	B+	B	B	B+	B+	B+	B	B	B	B	F	C
CBU-72 FAE	F	B	F	F	A-	B+	F	A-	B+	F	F	F	F	F	B	F	F	F	B+	C-
Mk 20 'Rockeye' II	F	F	F	B	B	F	F	B	F	B+	B+	B	B	B	B	B+	B+	B+	F	B
Retarded Bombs																				
Mk 20 'Rockeye'	F	F	F	B	B	F	F	B	F	B	B	B	B	B	B	B	B	B	F	C
Durandal	F	F	A+	F	F	D	C-	F	D	F	F	F	F	F	F	F	F	F	F	F
ISC B-1 minelets	F	F	A-	F	C	F	F	C	F	C-	C	F	F	F	F	C	C	C	F	F
Mk 82-1 'Snakeye'	F	F	D	B	B	F	F	B	F	B	F	C-	C-	C-	F	B	B	B	F	F
Mk 35 IN cluster	F	D	F	A-	B	F	F	B	F	A-	A-	C	C	C	A-	A-	A-	A-	F	C
Free-fall Bombs																				
Mk 82-0 'Slick'	F	C	D	C	B	D	D	B	D	B	C-	C	C	C	C	B	B	B	F	C
Mk 122 'Fireye'	F	C-	F	B	B	C-	F	B	C-	B+	C	C	C	C	C-	B+	B+	B+	D	C

Air-to-Air Missiles (AAMs)

System Name	Nation or plane	Guidance System	Effective Range	Maximum Speed	Maneuverability
Long-Range Radar-Homing					
AA-6 Acrid	MiG-25	Semi-active Pulse Radar	50 km	Mach 4	Poor
AA-7 Apex	MiG-23	Semi-active Pulse Radar	34 km	Mach 3	Poor
AA-9 Amos	MiG-31	Semi-active Pulse Radar	82 km	Mach 3.5	Fair
AA-10 Alamo	MiG-29 or Su-27	Active Doppler Radar	64 km	Mach 3+	Good
AIM-7E Sparrow	F-4, F-15 or F-18	Semi-active Pulse Radar	44 km	Mach 3.7	Very good
AIM-120A AMRAAM	any USA	Active Doppler Radar	32 km	Mach 4	Very good
Short-Range Infrared-Homing					
AA-2 Atoll	any USSR	IR (first generation)	14 km	Mach 2.5	Very good
AA-6 Acrid (IR)	MiG-25	IR (first generation)	50 km	Mach 4	Poor
AA-7 Apex (IR)	MiG-23	IR (first generation)	34 km	Mach 3	Fair
AA-8 Aphid	any USSR	IR (second generation)	12 km	Mach 3	Excellent
AA-10 Alamo (IR)	MiG-29 or Su-27	IR (second generation)	64 km	Mach 3+	Good
AIM-9H Sidewinder	any Western	IR (first generation)	12 km	Mach 3+	Excellent
AIM-9M Sidewinder	any USA	IR (second generation)	17 km	Mach 3+	Excellent

Key to Air-to-Air Missiles (AAMs)

System Name: The name of the missile system.

Plane: The type of plane which can carry the missile. If a specific plane is listed, only those planes can carry that missile. Aircraft listed are restricted to those commonly encountered.

any USA means any plane of the US Air Force, but not current or former American allies (and therefore not Iran).

any Western means any plane of a western-allied nation, including former American allies such as Iran, or neutrals such as Sweden.

any USSR means any plane of a USSR-allied nation, including such Soviet allies as Libya, Finland, Iraq, East Germany, Czechoslovakia, Poland, etc.

Guidance System: How missile finds its target.

Semi-active Pulse Radar requires that the launching plane continue to "paint" the target with radar until the missile hits.

Active Doppler Radar means the missile has its own radar

set, allowing the plane to "fire and forget". In addition, the missile's doppler radar is only fooled by chaff if the the target plane generates a small doppler (by running perpendicular to the missile's course).

IR (first gen.) means the missile is a first generation infrared homer. It chases the hot engine exhaust only, and is easily fooled by jammers and flares.

IR (second gen.) means the missile is a second generation infrared homer. It aims at any hot part of a plane, including the nose, wings and tail as well as the engine exhausts. It can recover from jamming and continue seeking a target.

Effective Range: The maximum range at which the missile can "lock on" to a target.

Maximum Speed: The launching speed of the missile. Mach 1 is about 660 knots at sea level.

Surface-to-Air Missiles (SAMs)

Name	Mounting	Search Guidance	Search Range	Firing Guidance	Firing Range	Max Speed	Max Alt	Maneuverability
Long-Range Radar-Guided SAMs								
SA-2 Guideline	Site	Poor pulse radar	200 km	Beam-rider pulse radar	125 km	Mach 3+	55,000'	Very poor
SA-5 Gammon	Site	Poor pulse radar	350 km	Beam-rider pulse radar	150 km	Mach 3	95,000'	Poor
SA-10 Grumble	Site or vehicles	Superb dplr radar	320 km	SA+CG doppler radar	125 km	Mach 3	70,000'	Fair
SA-4 Ganef	Site or vehicles	Poor pulse radar	100 km	Semi-Active pulse radar	70 km	Mach 2.5	75,000'	Poor
SA-12 Gladiator	Vehicles	Good dplr radar	290 km	SA+CG doppler radar	150 km	Mach 3+	70,000'	Fair
SA-6 Gainful	Vehicles	Poor pulse radar	80 km	Semi-Active pulse radar	30 km	Mach 2.8	60,000'	Fair
SA-8B Gecko	Vehicle	Fair pulse radar	125 km	Semi-Active pulse radar	65 km	Mach 2	25,000'	Good
SA-11 Gadfly	Vehicle	Fair pulse radar	200 km	Semi-Active pulse radar	100 km	Mach 2.5	45,000'	Good
MIM-23B Hawk	Site	Good dplr radar	175 km	Semi-Active pulse radar	125 km	Mach 1.5	52,000'	Good
Rapier	Site or vehicle	Good pulse radar	75 km	Semi-active pulse radar	65 km	Mach 2+	24,000'	Very good
SA-N-4	Warship	Pulse radar	200km	Semi-Active pulse radar	30 km	Mach 2	25,000'	Good
SA-N-6	Warship	Doppler radar	320 km	SA+CG doppler radar	125 km	Mach 3	70,000'	Fair
SA-N-7	Warship	Doppler radar	50-200 km	Semi-Active pulse radar	100 km	Mach 2.5	45,000'	Good
Short-Range IR/Visual-Guided SAMs								
SA-7B Grail	Infantry	Eyesight	Eyesight	IR homing (first gen.)	10 km	Mach 1.5	20,000'	Good
SA-14	Infantry	Eyesight	Eyesight	IR homing (second gen.)	16 km	Mach 1.5+	20,000'	Excellent
FIM-43A Redeye	Infantry	Eyesight	Eyesight	IR homing (first gen.)	7 km	Mach 1.5	10,000'	Very good
FIM-92A Stinger	Infantry	Eyesight	Eyesight	IR homing (second gen.)	10 km	Mach 2	20,000'	Excellent
SA-9B Gaskin	Vehicle	Eyesight	Eyesight	IR homing (first gen.)	30 km	Mach 1.5	20,000'	Very good
SA-13 Gopher	Vehicle	Poor pulse radar	125 km	IR homing (second gen.)	65 km	Mach 1.5	30,000'	Very good
Tigercat	Site	Poor pulse radar	65 km	Visual	30 km	Mach 1.5	12,000'	Good
SA-N-5	Warship	Poor pulse radar	50-150 km	IR homing (first gen.)	30 km	Mach 1.5	20,000'	Good
Seacat	Warship	Poor pulse radar	200 km	Visual	30 km	Mach 1.5	12,000'	Good

Abbreviations:

Dplr	Doppler
gen.	generation
IR	Infrared
km	kilometers
Mach	speed of sound, about 520 to 660 kts, depending on altitude
SA+CG	Semi-active plus Command Guidance
Site	Ground site (fixed emplacement)

Key to Surface-to-Air Missiles (SAMs)

Name: The commonly used name of the system.

Mounting: How the system appears when seen.

Site means fixed missile launchers are positioned around a central radar station in a "star" pattern.

Vehicles (plural) means the missile launchers and radars are mounted on vehicles. The vehicles are usually parked on open ground in an irregular pattern. Radars and missile launchers are on separate vehicles, so they remain fairly close together.

Vehicle (singular) means each vehicle has both radars and missiles. Although a battery usually has 2 to 4 vehicles, often widely dispersed.

Warship means the radar and missile launcher are mounted on a warship.

Infantry means the missile is man-packed, and therefore carried by ground military units, including installation guards, as well as by well-equipped terrorists.

Search Guidance: The type and quality of search radar used by the missile. Eyesight is a very poor search method.

Doppler Radar measures the change in range; it is most effective when you fly toward or away from it, least effective when you arc around it at a constant distance.

Pulse Radar bounces signals off a surface; it is most effective when you fly sideways to it, least effective when you fly straight at it.

Search Range: The theoretical maximum range of the search radar. However, against your F-19 radar performance is greatly reduced. The quality of the radar and local conditions determine its real, effective range.

Firing Guidance: The way the missile finds your aircraft. Pulse and doppler radars have varying effectiveness depending on your flight path in relation to the missile (see search guidance, above, for details).

Beam-Rider pulse radar means the missile uses pulse radar guidance, with the radar receiver at the launching site. It cannot "burn through" jamming at close range.

Semi-Active pulse radar means the missile use pulse radar guidance, with the radar receiver in the missile. Therefore it may "burn through" jamming at close range.

Semi-Active dplr radar means the missile uses doppler radar guidance, with the radar receiver in the missile. It too can "burn through" jamming at close range.

SA+CG dopper radar means the missile uses doppler radar guidance, with the radar receiver in the missile. It can "burn through" jamming at close range. In addition it has command guidance that permits multiple attacks (should the first attack miss).

IR homing (first gen.) means the missile uses infrared homing that seeks hot exhausts. It is very vulnerable to both jamming and flares.

IR homing (second gen.) means the missile uses infrared homing that seeks any hot surface, including nose, wing edges, tail, etc. It has logic circuits that help it recover from jamming or flares.

Visual means the missile is guided by a controller on the ground, who must watch your plane and react to your maneuvering.

Firing Range: Maximum range at which the missile is fired.

Max Speed: Maximum speed in flight of the missile. Mach 1 is about 520 to 660 kts.

Max Alt: Maximum altitude the missile can reach.

Maneuverability: The turning ability of the missile in flight.

Air-to-Air Armament

F-19 Weaponry

Very short range general purpose gun

Quantity: 1 fixed internally

Effective Range: 3 km

Maximum Range: 6 km

Attack Technique: Tracking camera/laser historical gunsight

Notes: This six-barrel gatling-gun type cannon is the standard internal armament of most US fighters today, including the F-4, F-14, F-15, F-16 and F-18. It can fire 6,000 rounds a minute, a high rate of fire that increases the chance that a shell will be in the "same piece of sky" as the target aircraft. Of course, this rate of fire also means that a wise pilot must fire in short bursts (otherwise he'll quickly exhaust all his ammunition).

M61A1 20mm "Vulcan"

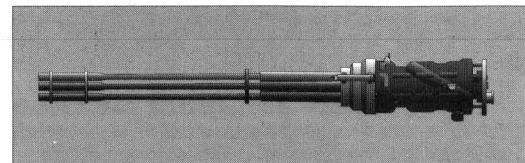

Short range air-to-air missile with infrared homing

Quantity on rack: 4

Guidance: Second generation ("all aspect") infrared seeker

Effective Range: 17 km

Missile Speed: Mach 3+

Missile Maneuverability: Excellent

Attack Technique: Air-to-Air "fire and forget"

Notes: Almost every aspect of this missile has been redesigned and upgraded numerous times. The "M" model is the latest, with a greatly improved all-aspect seeker head, a new warhead and an improved rocket engine. Although an "N" model exists, it represents rebuilds of early "B" and "E" models and is less reliable.

AIM-9M "Sidewinder"

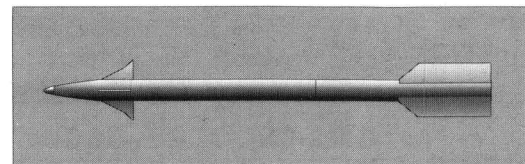

Medium range air-to-air missile with active radar homing

Quantity on rack: 3

Guidance: Active radar homing (has its own radar in nose)

Effective Range: 32 km

Missile Speed: Mach 4

Missile Maneuverability: Very good

Attack Technique: Air-to-Air "fire and forget"

Notes: This the West's first radar-guided "fire and forget" missile. The AMRAAM (advanced medium range air-to-air missile) has its own inertial guidance, onboard track-while-scanning radar, and computerized target discrimination. Pre-production and early production models are becoming available to Stealth units.

AIM-120A AMRAAM

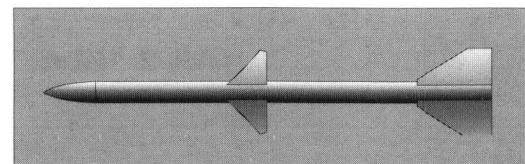

Enemy Cannons

M61A1 20mm "Vulcan"

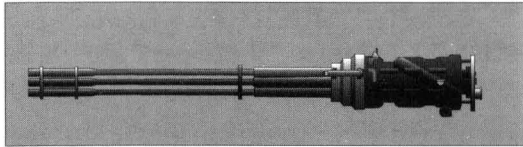

Very short range general purpose gun

Effective Range: 3 km

Maximum Range: 6 km

Attack Technique: Radar predicting gunsight

Notes: This gun is carried by Iranian F-4 Phantom and F-14 Tomcat fighters, which were purchased from the USA in the 1970s (when Iran was still an American ally).

GSh-23 23mm Cannon



Very short range general purpose gun

Effective Range: 3 km

Maximum Range: 6 km

Attack Technique: Radar predicting gunsight

Notes: This is the standard aerial cannon of USSR-built aircraft. It is a twin-barrel design that fires about 3000 rds/minute. Range is equivalent to the US weapon. The slow rate of fire (compared to the American M61) makes it a less effective weapon. A six-barrel version with a rate of fire equivalent to the American weapon may arm the MiG-29 and/or Su-27.

Enemy IR AAMs

AIM-9H "Sidewinder"

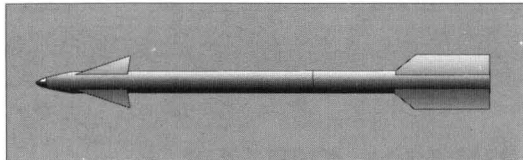

Short range air-to-air missile with infrared homing

Effective Range: 12 km

Missile Speed: Mach 3+

Missile Maneuverability: Excellent

Attack Technique: Locks onto tail exhaust, then "fire and forget"

Notes: This was the most advanced model Sidewinder sold by America to Iran. The missile is solid, reliable and easy to maintain — admirable features that unfortunately mean it must be taken seriously by American planes flying against Iran.

AA-2 "Atoll"

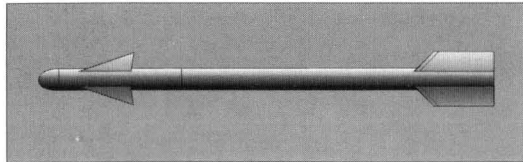

Short range air-to-air missile with infrared homing

Guidance: First generation infrared seeker

Effective Range: 14 km

Missile Speed: Mach 2.5

Missile Maneuverability: Very good

Attack Technique: Locks onto tail exhaust, then "fire and forget"

Notes: This early 1960s vintage IR missile is now obsolete. However, it was produced in vast quantities and sold throughout the world to Soviet clients. As a result, it is still carried by aircraft of poorer nations, as well as the second-line planes of larger and richer nations.

Medium range air-to-air missile with infrared homing

Guidance: First generation infrared seeker

Effective Range: 50 km

Missile Speed: Mach 4

Missile Maneuverability: Poor

Attack Technique: Locks onto tail exhaust, then "fire and forget"

Notes: Designed exclusively for the MiG-25 interceptor, this missile is an IR version of the powerful AA-6 radar homer (see below).

AA-6 "Acrid" (IR)

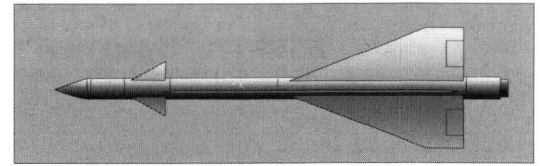

Medium range air-to-air missile with infrared homing

Guidance: First generation infrared seeker

Effective Range: 34 km

Missile Speed: Mach 3

Missile Maneuverability: Fair

Attack Technique: Locks onto tail exhaust, then "fire and forget"

Notes: This missile is an IR version of the AA-7 radar guided AAM (see below). It is most commonly found on MiG-23s.

AA-7 "Apex" (IR)

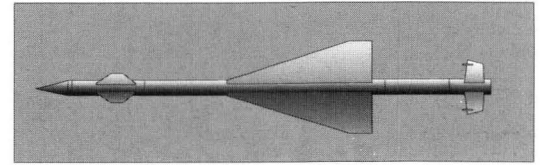

Short range air-to-air missile with infrared homing

Guidance: Early second generation infrared seeker

Effective Range: 12 km

Missile Speed: Mach 3

Missile Maneuverability: Excellent

Attack Technique: All-aspect lock on, then "fire and forget"

Notes: This small, lightweight missile is a pure dogfighting missile. Although its IR seeker may be inferior to the AIM-9M, it is considerably superior to earlier Soviet designs. This missile is replacing the now obsolete AA-2, and is carried by just about every Soviet-built fighter, interceptor and combat helicopter now in service. Soviet clients within Europe have the weapon, as do an increasing number of client states and customers around the world.

AA-8 "Aphid"

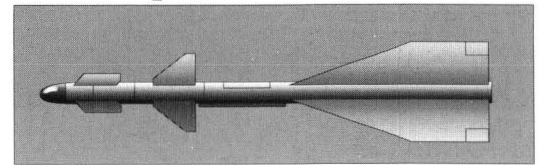

Medium range air-to-air missile with infrared homing

Guidance: Second generation infrared seeker

Effective Range: about 64 km

Missile Speed: Mach 3+

Missile Maneuverability: Good

Attack Technique: All-aspect lock on, then "fire and forget"

Notes: This missile is the IR version of the AA-10. It may be the longest-ranged second-generation IR missile in Soviet inventory today.

AA-10 "Alamo" (IR)

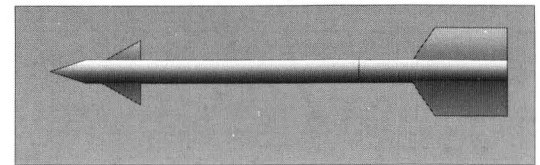

Enemy Radar AAMs

AIM-7E "Sparrow"

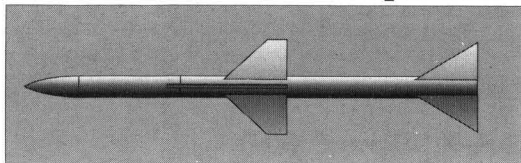

Medium range air-air missile with semi-active radar homing

Guidance: Semi-active radar homing (requires radar guidance from plane)

Effective Range: 44 km

Missile Speed: Mach 3.7

Missile Maneuverability: Very good

Attack Technique: Semi-active radar guided from launching aircraft

Notes: Nicknamed "The Great White Hope" because of its prominent exhaust plume, this missile was America's standard radar AAM in the 1960s and 1970s. The missile is not especially accurate, and depends on a close match with the firing aircraft's radar. Both the missile and radar demand regular and exacting maintenance. Although Iranian F-4s have this weapon, all these drawbacks greatly compromise its effectiveness.

AA-6 "Acrid" (Radar)

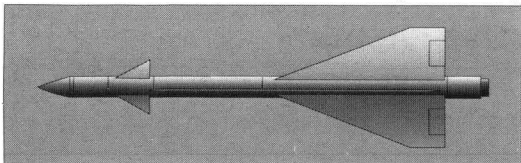

Long range air-air missile with semi-active radar homing

Guidance: Semi-active radar homing (requires radar guidance from plane)

Effective Range: 50 km

Missile Speed: Mach 4

Missile Maneuverability: Poor

Attack Technique: Semi-active radar guided from launching aircraft

Notes: This huge missile is the standard long-range armament of PVO MiG-25 interceptors, and is roughly equivalent (although technically inferior) to the Phoenix AAM on the F-14. The missile is matched purely to the MiG-25; other aircraft cannot control it. MiG-25Rs sold to Soviet client states are not normally equipped with this weapon.

AA-7 "Apex" (Radar)

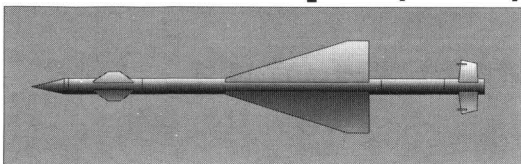

Medium range air-air missile with semi-active radar homing

Guidance: Semi-active radar homing (requires radar guidance from plane)

Effective Range: 34 km

Missile Speed: Mach 3

Missile Maneuverability: Poor

Attack Technique: Semi-active radar guided from launching aircraft

Notes: This was the standard USSR radar homing missile of the 1970s, the Russian equivalent of the AIM-7 "Sparrow". It requires a matching aircraft radar, found in MiG-23s of the USSR and Warsaw Pact. Many MiG-23s sold to smaller Soviet clients outside of Europe had inferior radars incapable of controlling this missile.

Long range air-air missile with semi-active radar homing

Guidance: Semi-active radar homing (requires radar guidance from plane)

Effective Range: 82 km

Missile Speed: Mach 3.5

Missile Maneuverability: Fair

Attack Technique: Semi-active radar guided from launching aircraft

Notes: This new, large missile is a revision or redesign of the AA-6 "Acrid", and is designed exclusively for the MiG-31 interceptor. There are some reports that the missile is an active radar homer (i.e., has its own radar), allowing "fire and forget" launching. There is even speculation that the missile could receive mid-course corrections from the launching aircraft or a ground radar station, but it is unlikely that Russian computer electronics are capable of successfully implementing this yet.

AA-9 "Amos"

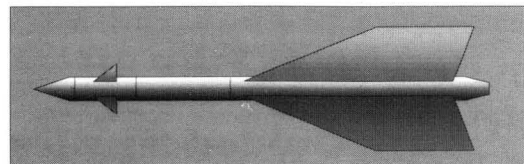

Medium range air-air missile with active radar homing

Guidance: Active radar homing (has its own radar in nose)

Effective Range: 64 km

Missile Speed: Mach 3+

Missile Maneuverability: Good

Attack Technique: Active radar homing independent of launching aircraft

Notes: This new, medium-sized radar AAM is strongly believed to be an active radar homer, that is, it carries its own onboard radar for "fire and forget" use, like the AIM-120 AMRAAM. It is commonly found on the new MiG-29 and

AA-10 "Alamo"

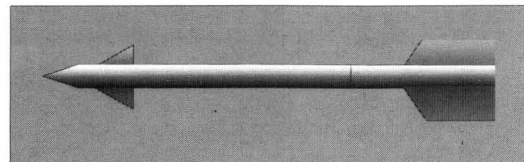

Air-to-Ground Armament

M61A1 20mm Cannon

The 20mm cannon listed in the air-to-air armament section can be used against ground targets as well.

Guided Missiles

Penguin-3 ASM

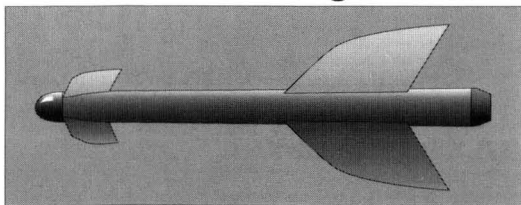

Medium-altitude infrared-homing anti-ship missile

Quantity per bay: 2

Acceptable (grade B) Targets: Ships at sea

Effective Range: 32 kilometers

Maximum Speed: Mach 0.8

Attack Technique: Air-Ground fire-and-forget launch against any warship

Minimum Launch Altitude: 500'

Maximum Launch Altitude: 40,000'

Notes: Designed by Norway, this modestly-sized and -priced missile is aimed at a point on the surface, and flies there under its own inertial guidance. At this pre-designated point the missile switches on an infrared homer, seeking out the heat of a ship against the cool ocean background. The missile is not a sea-skimmer, and is therefore easier to shoot down. However, the missile's guidance systems are entirely passive (unlike the Harpoon, which broadcasts its presence with radar signals). Although maximum range in high altitude launch is supposedly 80 kilometers, the range used here is appropriate to a lower altitude attack. Supplies of this weapon are limited because the US government is reluctant to purchase weapons from the same source that sold important military technology to the USSR in 1981.

AGM-84A "Harpoon"

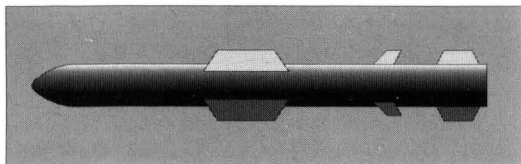

Sea-skimming radar- & inertial-guided anti-ship missile

Quantity per bay: 1

Optimum (grade A) Targets: Ships at sea

Effective Range: 60 kilometers

Maximum Speed: Mach 0.8

Attack Technique: Air-Ground fire-and-forget launch against any warship

Minimum Launch Altitude: 500'

Maximum Launch Altitude: 40,000'

Notes: The Harpoon is the standard anti-ship missile of the American Navy and Air Force. This weapon is more powerful, longer ranged and harder to stop than the Penguin. It is launched under inertial guidance with considerable computer assistance, flying at sea-skimming altitudes to avoid detection. At a pre-programmed point it turns on its radar, to find and home in on the target. Depending on the terminal guidance package installed it will either pop up and dive on the target, or fly straight in. Like most anti-shiping missiles, the remaining rocket fuel is almost as destructive as the warhead itself.

High speed anti-radiation ("homes on radar") missile

Quantity per bay: 1

Optimum (grade A) Targets: Ground radar stations

Acceptable (grade B) Targets: Warship radars

Effective Range: 20 kilometers

Maximum Speed: Mach 2+

Attack Technique: Air-ground fire-and-forget launch against any radar

Minimum Launch Altitude: 500'

Maximum Launch Altitude: 60,000'

Notes: This is America's most advanced anti-radar missile. It can lock and home on hostile radars even if they jump frequencies or switch off. The US Defense Department has hinted that it can even home on radar set components that are still warm, even if the set itself is turned off! The missile also has a "loiter" mode where it is fired blind and circles, waiting for a hostile radar to appear so it can attack it. The "loiter" attack mode is not available to HARMs carried on the F-19.

AGM-88A HARM

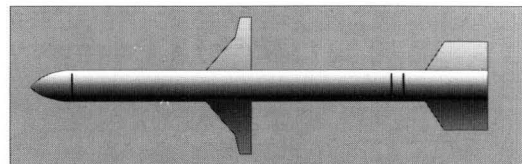

Thermal-imaging air-to-ground guided missile

Quantity per bay: 2

Acceptable (grade B) Targets: Bridges, bunkers, radar sites, oil facilities, ships

Poor (grade C) Targets: Airbase hangars, ground planes, buildings, depots, missile sites

Effective Range: 32 kilometers

Maximum Speed: Mach 1+

Attack Technique: Air-ground fire-and-forget launch

Minimum Launch Altitude: 500'

Maximum Launch Altitude: 40,000'

Notes: The Maverick is America's standard air-to-ground guided missile, and has a wide variety of guidance systems. The original design put a simple video camera in the missile's nose. While the missile remained attached to the plane the pilot used a miniature stick and screen to aim the bomb at the target below, locked it in, and released the weapon. Once in flight the bomb steered toward the image locked into its computer brain. Later versions added zoom lenses, PAVE TACK lasers, and ultimately, in the "D" model, a FLIR (forward-looking infrared) thermal imaging system that can "see" through clouds, smoke, and night. The missile usually carries a shaped-charge warhead for maximum effect against hardened targets impervious to normal bombing attacks. However, high explosive warheads can be fitted instead for maximum destructive effect against unarmored targets.

AGM-65D "Maverick"

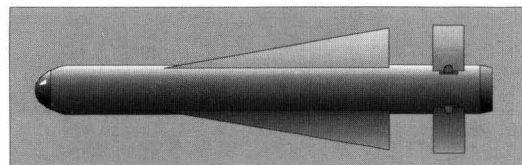

Laser-Guided Bombs

GBU-12 Paveway

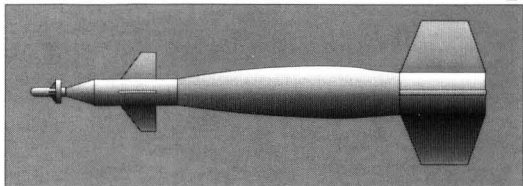

Laser-guided glide bomb

Quantity per bay: 2

Acceptable (grade B) Targets: Hangars, buildings, bridges, bunkers, depots, missile sites, radar sites, oil facilities

Poor (grade C) Targets: Ships

Effective Range: 2 kilometers per 1K' of altitude

Maximum Speed: Glide bomb

Attack Technique: Toss bombing or level bombing

Toss Bombing Attack Altitude: 500' and climb

Level Bombing Attack Altitude: 2,000' and turn away

Notes: The GBU-12 is one of the standard laser-guided bombs in the US armory. Large fighter-bombers like the F-111 favor heavier 1,000 lb and 2,000 lb models, but the F-19 must carry lighter weight munitions in its small bays. The Paveway guidance system is the most accurate way of placing a bomb on a target (short of using a guided missile like the Maverick). The advantage of using a bomb is that the weapon weight is almost entirely explosive, while guided missiles must, of necessity, use some of their weight for the rocket motor.

CBU-72 FAE

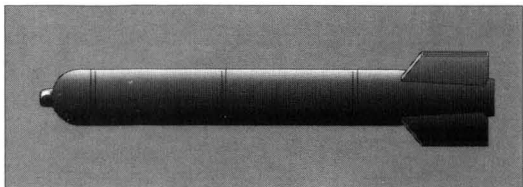

Laser-guided triple fuel-air explosive ("overpressure") bomb

Quantity per bay: 2

Optimum (grade A) Targets: Buildings

Acceptable (grade B) Targets: Submarine pens, hangars, bunkers, oil platforms

Poor (grade C) Targets: Ships

Effective Range: 2 kilometers per 1K' of altitude

Maximum Speed: Glide bomb

Attack Technique: Toss bombing or level bombing

Toss Bombing Attack Altitude: 500' and climb

Level Bombing Attack Altitude: 2,000' and turn away

Notes: This weapon contains a mixture of three heavier-than-air gases. When the bomb lands, the gases are released into the air, forming an explosive mixture. A delayed-action fuse ignites the mixture, which causes the contaminated air to burn. As well as incinerating everything, the burning gas expands instantly. In the open air this is sufficient to set off mines and flatten soft objects (such as men). However, in an enclosed space the effect is vastly magnified, with the walls, floor and roof of the structure broken and blown apart. The result in underground structures, like submarine pens, is total destruction.

Mk 20 "Rockeye" II

Laser-guided high-explosive cluster bomb

Quantity per bay: 2

Acceptable (grade B) Targets: Grounded planes, buildings, depots, missile

sites, radar sites, oil facilities, ships

Effective Range: 2 kilometer per 1K' of altitude

Maximum Speed: Glide bomb

Attack Technique: Toss bombing or level bombing

Toss Bombing Attack Altitude: 500' and climb

Level Bombing Attack Altitude: 2,000' and turn away

Notes: This weapon marries a laser guided glide-bomb system with a Mk 20 Rockeye cluster munition (see below). The laser guidance allows for earlier release and greater bomblet release accuracy. With an area weapon like a cluster bomb the former is more important, since it gives an increased safety margin to the launching aircraft.

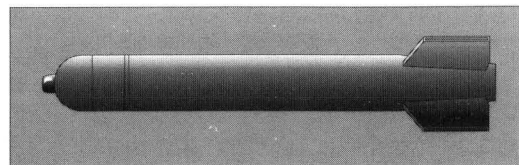

Retarded fragmentation cluster bomb

Quantity per bay: 2

Acceptable (grade B) Targets: Grounded planes, buildings, depots, missile sites, radar sites, oil facilities

Poor (grade C) Targets: Ships

Effective Range: Nil

Maximum Speed: Retarded bomb

Attack Technique: Low-altitude level bombing

Level Bombing Attack Altitude: 500'

Notes: This cluster bomb breaks open about 100' above the surface, spinning out 247 shaped-charge bomblets that can destroy buildings, armored vehicles, and people. The opening height and pattern can be pre-set for various types of targets. The U.S. Navy discovered these bombs were effective against small warships when a single cluster bomb wrecked a Libyan Nanuchka-class missile boat in 1986. Of course, not all warships are as vulnerable.

Retarded Bombs

Mk 20 "Rockeye"

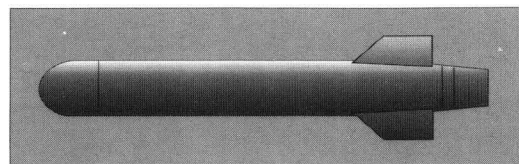

Parachute-deployed runway-penetration bomb

Quantity per bay: 2

Optimum (grade A) Targets: Runways

Poor (grade C) Targets: Bridges

Effective Range: Nil

Maximum Speed: Retarded bomb

Attack Technique: Low-altitude level bombing

Level Bombing Attack Altitude: 500'

Notes: This is the standard anti-runway weapon in the USAF arsenal, even though it's French made. When the Durandal is released over target it deploys a parachute. This causes it to float nose-down and roughly stationary over the runway surface. Then its rocket motor ignites, blasting the warhead straight down through the concrete, where a delayed action fuse explodes it. This heaves up large sections of runway surface, while smaller shards fly hundreds

Durandal Bomb

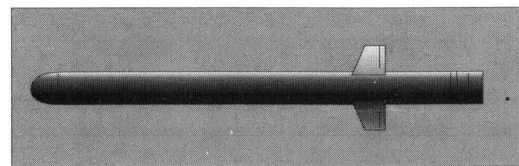

of feet through the air. The result is a thoroughly ruined surface and tons of wreckage that requires both heavy equipment and considerable time to repair.

ISC B-1 Minelets

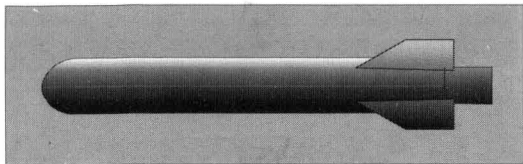

Parachute-deployed minelet dispenser

Quantity per bay: 1

Optimum (grade A) Targets: Runways

Poor (grade C) Targets: Buildings, depots, missile sites, oil facilities on land

Effective Range: Nil

Maximum Speed: Retarded bomb

Attack Technique: Low-altitude level bombing

Level Bombing Attack Altitude: 500'

Notes: This new weapon breaks open at altitude and dispenses a variety of small anti-personnel, anti-vehicle and delayed fuse mines. Used on airfields, they prevent flight operations until cleared. They can also cause problems around open-air structures such as refineries, oil wells, etc. Clearing the mines is complicated by the variety of types, as well as random delayed-fuse bombs (i.e., you'll never know when another will explode!).

Mk 82-1 "Snakeye"

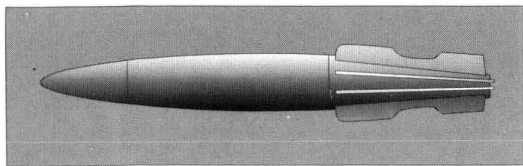

Retarded high-explosive ("iron") bomb

Quantity per bay: 3

Acceptable (grade B) Targets: Grounded planes, buildings, depots, oil facilities on land

Poor (grade C) Targets: Radar sites

Effective Range: Nil

Maximum Speed: Retarded bomb

Attack Technique: Low-altitude level bombing

Level Bombing Attack Altitude: 500'

Notes: Retarded bombs use parachutes or vanes to slow their descent, allowing the plane to clear the area before they land and explode. As a result, they can be dropped at lower altitude than free-fall bombs. However, they are less accurate, making them unsuitable against small targets. For the most accurate release, retarded bombs should be dropped in level flight. The Snakeye is the standard vane-type retarder unit for many US bombs, here attached to the Mk 82 500 lb. high-explosive bomb.

Mk 35 IN Cluster

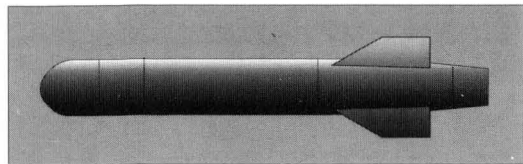

Retarded incendiary cluster bomb

Quantity per bay: 2

Optimum (grade A) Targets: Grounded planes, depots, missile sites, oil facilities

Acceptable (grade B) Targets: Buildings

Poor (grade C) Targets: Radar sites, ships

Effective Range: Nil

Maximum Speed: Retarded bomb

Attack Technique: Low-altitude level bombing

Level Bombing Attack Altitude: 500'

Notes: This cluster bomb is similar to the Rockeye, but filled with 57 incendiary bomblets. The cluster breaks apart in mid-air, spreading the bomblets over an area of several hundred yards. Then each bomblet spreads a burning liquid wherever it lands. The result is a raging fire that completely covers a wide area.

Free-fall high-explosive ("iron") bomb

Quantity per bay: 3

Acceptable (grade B) Targets: Buildings, depots, oil facilities on land

Poor (grade C) Targets: Hangars, grounded planes, missile sites, radar sites, oil platforms, ships

Effective Range: Nil

Maximum Speed: Free-fall bomb

Attack Technique: Level bombing or dive bombing

Level Bombing Attack Altitude: 3,000'

Dive Bombing Attack Altitude: Dive from 8,000', release at 3,000'

Notes: This weapon is the traditional 500 pound high explosive bomb, virtually unchanged in concept since WWII. The effectiveness of this bomb depends almost entirely on the skill of the bomber. The most important consideration when using "iron" bombs is that releases below 2,000' don't give the bomb sufficient time to arm in flight, causing "dud" hits. This occurred frequently in the Falklands war of 1982, when Argentine pilots repeatedly hit British ships with bombs dropped from 50' to 100'. Not one bomb exploded.

Free-fall incendiary ("fire") bomb

Quantity per bay: 2

Acceptable (grade B) Targets: Grounded planes, buildings, depots, oil facilities on land

Poor (grade C) Targets: Hangars, bunkers, missile sites, radar sites, oil platforms, ships

Effective Range: Nil

Maximum Speed: Free-fall bomb

Attack Technique: Level bombing or dive bombing

Level Bombing Attack Altitude: 3,000'

Dive Bombing Attack Altitude: Dive from 8,000', release at 3,000'

Notes: This weapon contains incendiary gel that spreads a burning liquid over a wide area. The liquid can flow into vents, grates, weapon slits, etc., making it effective against vehicles and fortifications as well as open-air targets. Of course, the bomb must be placed on the target with some accuracy to achieve this effect. Bombing skill is extremely important with this weapon.

Free-Fall Bombs

Mk 82-0 "Slick"

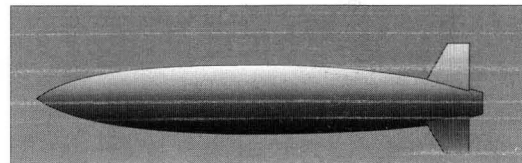

Mk 122 "Fireeye"

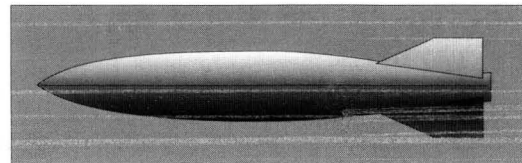

Other Equipment

135mm/IR Camera

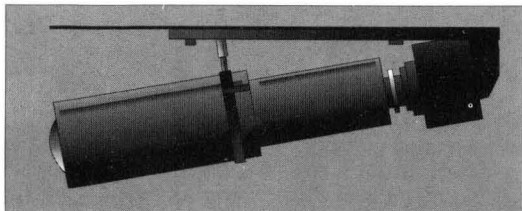

Visual & infrared photographic reconnaissance camera

Quantity per bay: 1

Targets: Any

Effective Range: Not applicable

Maximum Speed: Not applicable

Attack Technique: Level low-altitude photographic run

Photo Run Altitude: 200'

Notes: This pallet contains a 135mm high-resolution camera for use in visible light, and a second camera for infrared (IR) thermal photography. Both photographs are taken simultaneously, under pilot control. When this camera is deployed through the bomb bay, the F-19's tracking camera is "frozen" into a pre-programmed position, allowing it to function as a viewer for the big 135mm lens.

1900 lbs Fuel

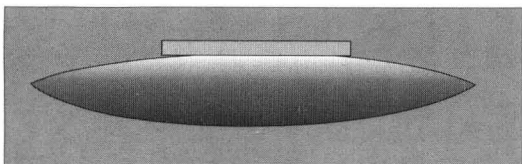

Additional fuel for extended range flying

Quantity per bay: 1

Targets: Not applicable

Effective Range: Improves flight range by 19% per tank

Speed: Not applicable

Attack Technique: Not applicable

Altitude: No effect

Notes: This fuel container gives extra range with the minimum container weight. It replaces the weapons mounting equipment in one bay. The fuel can be transferred to the main tanks with a flip of the switch. The F-19 turbofan engine fuel lines run only to the main tanks; the engines cannot be fed directly from extra tanks.

Special Equipment

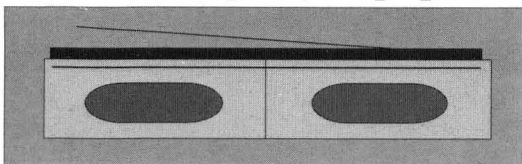

The data below refers to airdropping secret equipment

Quantity per bay: 1

Targets: Not applicable

Effective Range: Not applicable

Maximum Speed: Not applicable

Attack Technique: Airdrop from level flight or land at airstrip

Airdrop Altitude: 500' to 1,000'

Notes: Airdropped equipment in the F-19 uses a simple ripcord-and-chute design. When the equipment package is released from the weapons bay, a long ripcord remains attached. Within a second the cord draws taut and pulls open the chute.

Surface-to-Air Missile Systems

Radar Ratings: Pulse radars are generally less effective than doppler radars. Obsolescent radars of either type are greatly inferior to modern radars. As a result, modern doppler radars are the most dangerous, while obsolescent pulse radars are the least dangerous.

Ranges are given in kilometers. Note that the maximum firing range is often less than the maximum search range, due to the limited fuel carried by most missiles.

Guidance Systems: *Radar guided* missiles, with or without command guidance, are confused by your ECM jammer unless they are very close. If they are close, chaff is needed instead. *Infrared guided* missiles are confused by your IR jammer unless very close, where flares are used instead. A decoy is effective against any type of missile.

Visually guided missiles cannot be fooled, but are usually slow reacting, allowing you to outmaneuver them fairly easily.

Maximum speed is a useful measure of whether you can outrun a missile, and how much reaction time you have if one is fired. Mach 1 or 2 missiles are fairly slow and easier to deal with. Mach 3 or faster missiles are much more formidable opponents.

Maximum altitude is also a useful measure, since in some cases you can fly above the missile's ceiling.

Maneuverability indicates how easy it is to outmaneuver the missile. The less maneuverable the missile, the better your chance of turning perpendicular to its course and outmaneuvering it.

SAM Technical Specifications

The standard long-range SAM is controlled by radar. First the search radar scans the sky to find your plane. Search radars are graphically portrayed in the preflight briefing, and on your cockpit CRT maps.

When the search system finds your plane, it will "hand off" the prospective target to a narrow-beam fire control radar, usually running on a different frequency. The "TRAK" warning light in the cockpit alerts you whenever a narrow-beam tracking radar "paints" your craft. Tracking continues while the missile is airborne.

Beam Rider radar-guided missiles are the least flexible. They "ride" the controlling radar's beam. They can be easily jammed, have poor maneuverability, and cannot "turn around" for a second attack if they miss.

Semi-Active radar-guided missiles are more flexible. They can "burn through" jamming as they approach the target, and often have better maneuverability. However, like beam riders, they cannot "turn around" for a second

Radar-Controlled SAMs

attack if they miss.

Command Guidance radar-guided missiles are the most flexible. Like semi-active missiles, they can burn through jamming at short distances and have good maneuverability. In addition, they can be commanded to turn around and try again if they miss on the first pass.

SA-2 Guideline

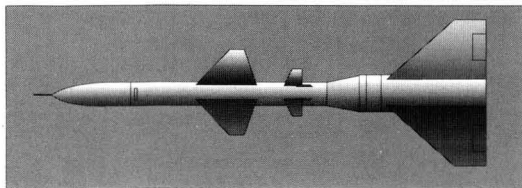

Long-range fixed-site radar-homing SAM.

Battery Configuration: Radar bunker with missile emplacements

Search System: Obsolescent pulse radar

Maximum Search Range: 200 kilometers

Guidance System: Obsolescent pulse radar "beam rider".

Maximum Firing Range: 125 kilometers

Maximum Speed: Mach 3+

Maximum Altitude: 55,000'

Maneuverability: Very poor

Notes: This very old system is used by many third-world nations outfitted with Soviet equipment. Although the radar systems have been upgraded over the last two decades, they are still inferior to modern systems. The last time SA-2s were used effectively was in the air defense of North Vietnam in the early 1970s. Today it is almost worthless.

SA-5 Gammon

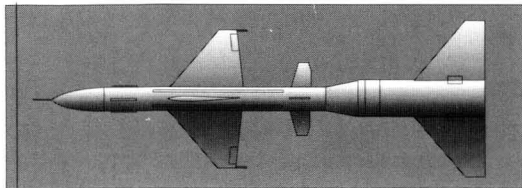

Long-range fixed-site radar-homing SAM.

Battery Configuration: Radar bunker with missile emplacements

Search System: Obsolescent pulse radar

Maximum Search Range: 350 kilometers

Guidance System: Obsolescent pulse radar "beam rider"

Maximum Speed: Mach 3

Maximum Firing Range: 150 kilometers

Maximum Altitude: 95,000'

Maneuverability: Poor

Notes: The SA-5 is the largest and longest-ranged SAM in the world today. However, bigger is not always better. Missile accuracy at extreme ranges is poor, its radar control system mediocre, and the huge missile has very poor maneuverability. Still, the extreme range poses a formidable threat. In its 1986 exchanges with Libya, the U.S. Navy's first priority was disabling the SA-5 Gammon batteries with HARM missiles.

SA-10 Grumble

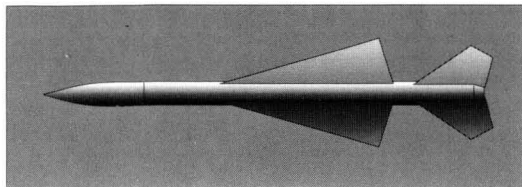

Long-range fixed-site or vehicular radar-homing SAM.

Battery Configuration: Radar bunker or armored vehicle with missile emplacements or armored vehicle missile launchers

Search System: Phased-array doppler radar

Maximum Search Range: 320 kilometers

Guidance System: Modern doppler radar & command guidance

Maximum Speed: Mach 3

Maximum Firing Range: 125 kilometers

Maximum Altitude: over 70,000'

Maneuverability: Fair

Notes: This semi-mobile all-altitude defense system was originally designed to defend the borders of the USSR from both cruise missiles and aircraft. However, recent failures to detect and engage low-flying aircraft suggest this system is less than perfect. The SA-10 is a "new generation" long-range air defense weapon designed to replace the obsolescent SA-5 Gammon. Because this weapon is new, details may be inaccurate.

Medium range fixed site or vehicular radar-homing SAM.

Battery Configuration: Radar bunker with missile emplacements, or radar and launcher on tracked vehicles.

Search System: Obsolescent pulse radar

Maximum Search Range: 100 kilometers

Guidance System: Obsolescent pulse radar & semi-active radar homing

Maximum Firing Range: 70 kilometers

Maximum Speed: Mach 2.5

Maximum Altitude: 75,000'

Maneuverability: Very poor

Notes: The SA-4 was Russia's first mobile, battlefield SAM, designed to accompany large military formations as they maneuver on the battlefield. It operates in the rear areas of the front lines, attacking aircraft that IR SAMs fail to hit. The SA-4 entered service in the 1960s. It is now obsolescent, found only in 2nd and 3rd line Russian units. It has been sold extensively to Russian allies and client states.

Medium/long-range site or vehicular radar-homing SAM.

Battery Configuration: Temporary site with radar and missile launchers, or dispersed radar and launcher vehicles.

Search System: Phased-array doppler radar

Maximum Search Range: 290 kilometers

Guidance System: Modern doppler radar & command guidance

Maximum Speed: Mach 3+

Maximum Firing Range: 150 kilometers

Maximum Altitude: over 70,000'

Maneuverability: Fair

Notes: This very new system is believed to be a semi-mobile SAM designed to accompany armies, deploying far to the rear. From that position the missile can provide a wide umbrella of defense against both air raids and missile attacks. Because this weapon is quite new, the details may be inaccurate.

Medium range vehicular radar-homing SAM.

Battery Configuration: Radar and launcher on tracked vehicles.

Search System: Obsolescent pulse radar

Maximum Search Range: 80 kilometers

SA-4 Ganef

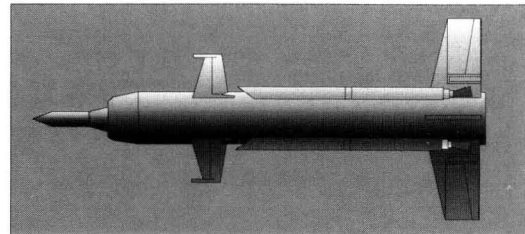

SA-12 Gladiator

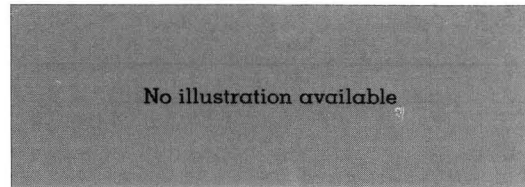

SA-6 Gainful

SA-6 Gainful

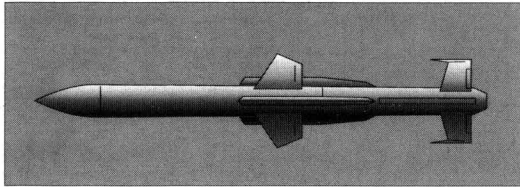

Guidance System: Obsolescent pulse radar & command guidance

Maximum Firing Range: 30 kilometers

Maximum Speed: Mach 2.8

Maximum Altitude: 60,000'

Maneuverability: Fair

Notes: This medium range battlefield SAM is also obsolescent in the Russian Army, but extensively used by the first-line forces of Soviet allies and client states. It is designed to accompany combat troops, protecting them from positions only a short distance behind the front lines. The missile was very effective in the first few days of the 1973 Arab-Israeli War, but soon succumbed to advanced ECM jammers.

SA-8 Gecko

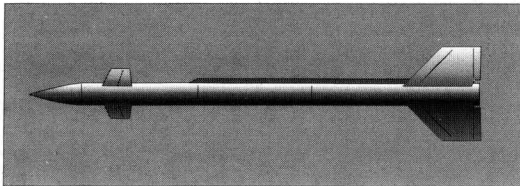

Medium range vehicular radar-homing SAM.

Battery Configuration: Radar and launcher on a single vehicle

Search System: Modern pulse radar

Maximum Search Range: 125 kilometers

Guidance System: Modern pulse radar, semi-active with video backup

Maximum Speed: Mach 2

Maximum Firing Range: 65 kilometers

Maximum Altitude: 25,000'

Maneuverability: Good

Notes: This shorter-ranged but higher quality successor to the SA-6 was the standard "up front" radar SAM of the Soviet Army in the 1970s and early 1980s. Now being replaced by the SA-11, it is likely to appear among the armies of Russia's allies and client states soon.

SA-11 Gadfly

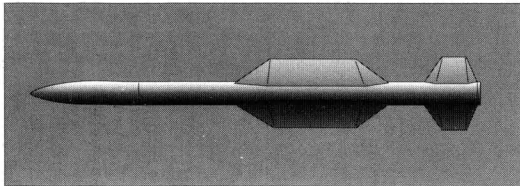

Medium range vehicular radar-homing SAM.

Battery Configuration: Radar and launcher on a single vehicle

Search System: Modern doppler radar

Maximum Search Range: 200 kilometers

Guidance System: Modern pulse radar, backup unknown

Maximum Speed: Mach 2.5

Maximum Firing Range: 100 kilometers

Maximum Altitude: 45,000'

Maneuverability: Good

Notes: This weapon is the "next generation" battlefield radar SAM, designed to replace the SA-6 and SA-8. The weapon is very new, and details may well be inaccurate.

MIM-23B Hawk

Medium range fixed site radar-homing SAM.

Battery Configuration: Radar bunker or trailer with missile launcher emplacements or trailers

Search System: Modern pulse radar

Maximum Search Range: 175 kilometers

Guidance System: Modern pulse radar & command guidance

Maximum Speed: Mach 1.5

Maximum Firing Range: 125 kilometers

Maximum Altitude: 52,000'

Maneuverability: Good

Notes: The HAWK has long been the standard SAM of the USA, with various models exported to allies, including Iran. Lt. Colonel North's famous arms deal to Iran included extra parts and missiles for HAWK batteries, then Iran's most powerful air defense system. This missile was adequate for the 1970s, but is no longer "state of the art" against first-line 1980s aircraft. The US Army's replacement, the MIM-104 "Patriot", has not been sold to any other nation.

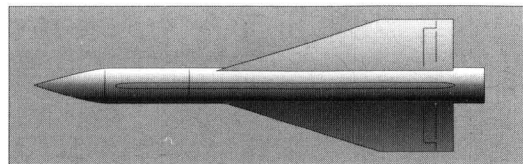

Short-range fixed site visual/radar-homing SAM.

Battery Configuration: Combined radar and launcher pedestal, or on tracked vehicle

Search System: Modern pulse radar

Maximum Search Range: 75 km

Guidance System: Optical command guidance with semi-active pulse radar backup

Maximum Speed: Mach 2+

Maximum Firing Range: 65 km

Maximum Altitude: 24,000'

Maneuverability: Very good

Notes: This is a British high-precision, high-speed SAM for general battle-field defense (roughly equivalent to the SA-8). However, it is greatly hampered by its short range, and was not very effective in the Falklands for this reason. Fixed pedestal versions were sold to the Iranian air force for airbase defense.

Rapier

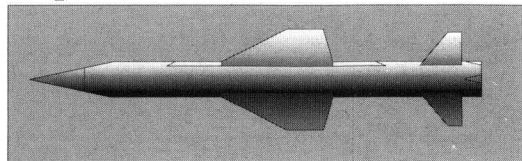

Medium range area-defense naval SAM.

Battery Configuration: Integral to warship

Search System: depends on the ship, usually some type of pulse radar

Maximum Search Range: depends on the ship, typically 100-200 km

Guidance System: Modern pulse radar with video backup

Maximum Speed: Mach 2

Maximum Firing Range: 30 kilometers

Maximum Altitude: 25,000'

Maneuverability: Good

Notes: This missile is the naval version of the SA-8 Gecko, used on some cruisers, frigates, newer missile boats (including the Nanuchka class), and amphibious warfare ships. The twin missile launcher pops up from an armored silo when ready to fire. The missiles can be fired against surface ships as well as airplanes, but are ineffective against modern anti-ship cruise missiles. This is a serious drawback, since many cruise missiles have a longer range than this SAM.

SA-N-4

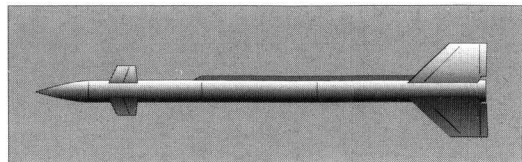

SA-N-6

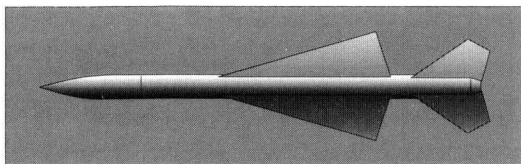

Medium range area-defense naval SAM.

Battery Configuration: Integral to warship

Search System: Phased-array doppler radar

Maximum Search Range: 300+ kilometers

Guidance System: Modern doppler radar & command guidance

Maximum Speed: Mach 3

Maximum Firing Range: 125 kilometers

Maximum Altitude: over 70,000'

Maneuverability: Average

Notes: This is the naval version of the SA-10 Grumble long-range air-defense SAM, mounted on the Kiev-class aircraft carriers and Kirov-class battlecruisers. It is an excellent all-altitude weapon capable of reaching out long distances to intercept incoming airstrikes before they launch their own missiles, as well as planes that approach more closely. It is also designed to shoot down incoming cruise missiles, should a hostile aircraft manage to launch one.

SA-N-7

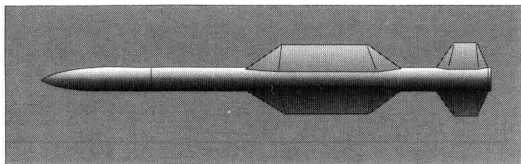

Medium range area-defense naval SAM.

Battery Configuration: Integral to warship

Search System: depends on ship, usually modern doppler radar

Maximum Search Range: depends on the ship, 50-200 kilometers

Guidance System: Modern pulse radar, backup unknown

Maximum Speed: Mach 2.5

Maximum Firing Range: 100 kilometers

Maximum Altitude: 45,000'

Maneuverability: Good

Notes: This is the naval equivalent of the SA-11 Gadfly, found on Sovremenny-class and later destroyers. It is a good self-defense weapon against air attacks that fly near or over the ship, but lacks the range to engage distant planes launching anti-ship cruise missiles. This missile is not good enough to shoot down anti-ship cruise missiles, but the Sovremennyy's carry 30mm gatling guns for that job.

Short Range IR & Visual SAMs

Expensive, sophisticated short range SAMs rely on search radars, but the less expensive designs use simple eyesight. Once acquired, the target may be tracked by eyesight, cameras, or radar.

If the missile is an IR homer, it is aimed along the tracking line and its infrared seeker turned on. When the seeker locks onto the target the missile is launched. From that point onward the missile steers itself, using its seeker.

Infrared seekers home on heat sources. "First generation" seekers were easily confused by the sun, common distress flares, even greenhouses or sun-heated rocks. More modern "second generation" seekers have filters, improved technology and computer logic, making them more difficult to "fool" with jammers or flares.

Visually guided weapons require that the controller guide the missile to the target in sight. Early designs (such as the Tigercat and Seacat) required the controller to actually fly the missile like a plane, later designs (such as the Rapier) require that the controller just keep the target in his crosshairs — the missile automatically guides itself in whatever direction the crosshair sight indicates. Visually guided systems cannot be jammed, have trouble tracking wildly maneuvering targets, or even finding a target in bad visibility.

Short-range shoulder-launched infrared-homing SAM.

Battery Configuration: Carried by infantrymen, or in any light vehicle.

Search System: Eyesight

Maximum Search Range: Eyesight

Guidance System: Infrared homing (first generation)

Maximum Speed: Mach 1.5

Maximum Firing Range: 10 kilometers

Maximum Altitude: 20,000'+

Maneuverability: Good

Notes: One of the first shoulder-fired SAMs, this missile has good speed and range, but a very weak warhead. The IR seeker has been improved in the B model, but even more upgrades appeared in the SA-14 (see below).

Short-range shoulder-launched infrared-homing SAM.

Battery Configuration: Carried by infantrymen, or in any light vehicle.

Search System: Eyesight

Maximum Search Range: Eyesight

Guidance System: Infrared homing (first generation)

Maximum Speed: Mach 1.5

Maximum Firing Range: no more than 7 kilometers

Maximum Altitude: about 10,000'

Maneuverability: Very good

Notes: This was America's first shoulder-fired SAM, and was never really very effective. Its IR seeker was very simple, the warhead small, and the range and speed barely adequate. However, during the 1970s the US Army had nothing better, and a few NATO allies were loyal enough to buy it.

Short-range shoulder-launched infrared-homing SAM.

Battery Configuration: Carried by infantrymen, or in any light vehicle.

Search System: Eyesight

Maximum Search Range: Eyesight

Guidance System: Infrared homing (second generation all-aspect)

Maximum Speed: Mach 1.5+

Maximum Firing Range: about 16 kilometers

Maximum Altitude: 20,000'+

Maneuverability: Excellent

Notes: This is a completely upgraded version of the SA-7, with greater

SA-7B Grail

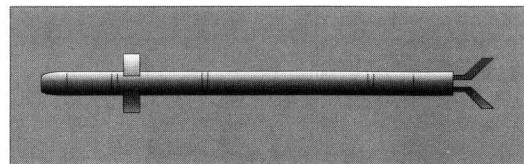

FIM-43A Redeye

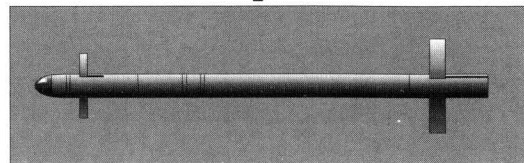

SA-14 & SA-16

No illustration available

speed, range, and a much improved IR seeker. Even further improvements and refinements will appear with the upcoming SA-16.

FIM-92A Stinger

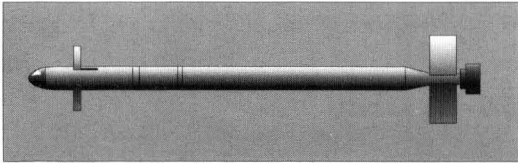

Short-range shoulder-launched infrared-homing SAM.

Battery Configuration: Carried by infantrymen, or in any light vehicle.

Search System: Eyesight

Maximum Search Range: Eyesight

Guidance System: Infrared homing (second generation all-aspect)

Maximum Speed: Mach 2

Maximum Firing Range: about 10 kilometers

Maximum Altitude: about 20,000'

Maneuverability: Excellent

Notes: Entering production in 1981, this was a much-needed replacement for the Redeye. The Stinger is a much more effective missile, largely because of its excellent and quite "intelligent" IR seeker. The CIA has been supplying quantities of this missile to guerilla movements, who in turn have traded or given this weapon to groups hostile to America, including the Iranian Shi'ite militia.

SA-9B Gaskin

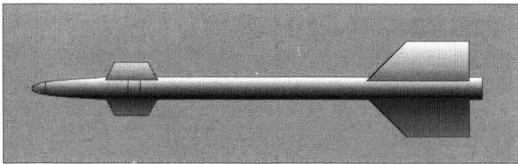

Short-range vehicle mounted infrared-homing SAM.

Battery Configuration: Radar and launcher on same armored vehicle

Search System: Eyesight

Maximum Search Range: Eyesight

Guidance System: Pulse radar aiming and infrared (IR) homing

Maximum Speed: Mach 1.5

Maximum Firing Range: 30 kilometers

Maximum Altitude: 20,000'

Maneuverability: Very good

Notes: This is an upgraded version of the SA-9 missile vehicle. The original design did very poorly in the Bekaa Valley against Israeli aircraft in 1981. The SA-9 is designed to accompany front-line combat units and provide low-level defense against strike aircraft and helicopters. The missile itself is fairly small and not especially destructive.

SA-13 Gopher

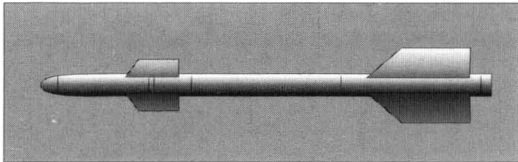

Short-range vehicle mounted infrared-homing SAM.

Battery Configuration: Radar and launcher on same armored vehicle

Search System: Obsolescent pulse radars or eyesight

Maximum Search Range: visual or 30-60 kilometer pulse radar

Guidance System: Pulse radar aiming and infrared (IR) homing

Maximum Speed: Mach 1.5

Maximum Firing Range: 65 kilometers

Maximum Altitude: 30,000'

Maneuverability: Very good

Notes: This is an improved SA-9 with a new launcher, better radar, and an improved missile. Unlike the SA-9, it can be linked with a separate search

radar system, including other obsolescent systems from older radar-guided SAMs. A number of third world nations have received this with the SA-9B missiles on the new tracked launcher.

Short-range fixed site visual SAM.

Battery Configuration: Emplacements with controller position, trailer launcher(s).

Search System: Visual or obsolescent pulse radar

Maximum Search Range: Eyesight or 65 kilometer pulse radar

Guidance System: Joystick (visual) command guidance

Maximum Speed: Mach 1.5

Maximum Firing Range: 30 kilometers

Maximum Altitude: 12,000'

Maneuverability: Good

Notes: This inexpensive land version of the Seacat missile is only useful for protecting installations from direct air raids. It is very short ranged, cannot reach high altitudes, and has a primitive "operator must fly the missile" control system. Missiles are heavy, and mounted on trailers that must be deployed well to the rear of any battlefield frontline. It's hard to take this missile seriously.

Short-range point defense naval SAM.

Battery Configuration: Integral to warship

Search System: Naval pulse radar of varying quality

Maximum Search Range: Varies with ship, 50-150 kilometers

Guidance System: Infrared (IR) homing

Maximum Speed: Mach 1.5

Maximum Firing Range: 30 kilometers

Maximum Altitude: 20,000'

Maneuverability: Very good

Notes: This is the naval version of the SA-7 Grail. Older frigates and missile boats (including the very common Osa class) use this system. The missiles are aimed visually, their IR locked on, and then fired. Larger launcher systems have four launching tubes and an operator position. The system is effective only against aircraft that fly close to the boat or ship.

Short-range point defense naval SAM.

Battery Configuration: Integral to warship

Search System: Obsolescent pulse radar (on Vosper Mk 5 Frigates)

Maximum Search Range: 200 kilometers (on Vosper Mk 5 Frigates)

Guidance System: Joystick (visual) command guidance

Maximum Speed: Mach 1.5

Maximum Firing Range: 30 kilometers

Maximum Altitude: 12,000'

Maneuverability: Good

Tigercat

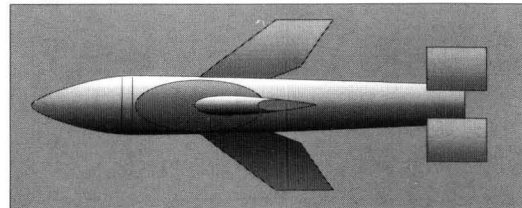

SA-N-5

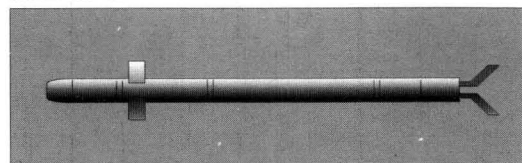

Seacat

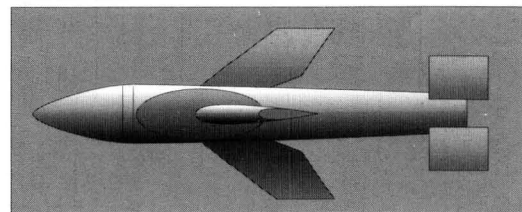

Notes: The Seacat missile is the naval version of the Tigercat, with the same primitive control system and short range. It is the anti-aircraft defense of Mark 5 frigates, built by Vosper in England for export. Iran bought a number of these ships. The Vosper's search radar is the obsolescent AWS-1, whose maximum range is 200 kilometers. Its effective range against a stealth aircraft would be much, much less.

Warplanes

Key to Aircraft

A *fighter* plane specializes in air-to-air combat, where the objective is destroying enemy aircraft.

An *interceptor* is a fighter designed to fly long distances and attack distant enemy aircraft. Many interceptors are poor dogfighters.

A *strike* plane is designed to hit surface targets in enemy territory. *Close support* strikes are against enemy front-line troops, *interdiction* strikes are against military rear areas (headquarters, supply dumps, columns on roads, etc.), while *deep strikes* attack enemy installations far behind the front line (railroad yards, bridges, airbases, etc.). *Strike* aircraft designed to function against warships are sometimes termed *attack* aircraft.

Bombers are designed for interdiction, deep strike, and/or naval attack, as well as carrying nuclear weapons and/or reconnaissance gear.

Transports carry personnel and equipment. They are not designed to fight, and almost never carry any armament.

AEW&C (*Airborne Early Warning & Control*) planes carry powerful search radar and communications gear, designed to watch friendly and hostile aircraft while simultaneously controlling friendly air operations.

If a plane has a crew of one man, cockpit aids are important: the workload for one man in a jet warplane is quite high.

This is the typical total weight of the plane, with fuel and weapons, at takeoff. If the plane can serve in both fighter and strike role, the fighter (air-to-air) weight is given. In a strike role a plane often carries 15-35% additional weight.

The total thrust of the engines (on afterburners if available) is important. Airplanes with greater thrust than weight can fly "ballistically", a useful advantage in air combat. A high thrust/weight ratio is desired by all fighter pilots.

This is the combat radius of the plane when loaded for action, but using only internal tanks (no extra fuel tanks). Often the figure is an approximation.

Maximum altitude of the plane, using afterburners if available.

Sea-level maximum speed is often much less than high altitude maximum speed, especially in high-speed jets.

This altitude level is an important benchmark because above it Mach 1 is a constant 573 knots. Although this speed is important, note that the optimum

Roles

Crew

Mission Weight

Engines

Range

Ceiling

Maximum Speed at 0'

Maximum Speed at 36,000'

turning speed for most aircraft is Mach 0.75 to 0.90 (i.e., 550-650 knots, depending on the plane and altitude); higher speeds are only good for chasing opponents, escaping from them, or quick dashes into and out of enemy airspace.

Armament

Often weapons pylons can be fitted to carry multiple bombs or lightweight missiles. The number of pylons need not limit the number of ordnance items.

Air-to-Air Radar Quality

As a stealth pilot, you are naturally interested in the range and quality of enemy airborne search radar.

Maneuverability

This is a comparative rating of how well the plane can maneuver in a dogfight. All aircraft are rated on the same standard: the superb maneuverability of the F-16 Falcon.

American-Built Warplanes

F-4E Phantom II

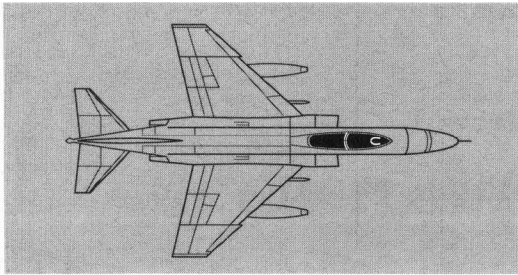

Designer/Manufacturer: McDonnell Douglas, USA

Role: Fighter & strike fighter

Crew: Two

Mission Weight at Takeoff: 27 tons

Engine(s): Two General Electric J79-17 turbojets for 35,800 lbs thrust

Range: 830 kilometers

Ceiling: 58,750'

Maximum Speed at 0': 800 kts

Maximum Speed at 36,000': 1260 kts

Armament: 6-barrel 20mm cannon, 4 missile recesses, 5 weapon pylons

Air-to-Air Radar Quality: Fair quality and range pulse radar

Maneuverability: Fair to good

Notes: This all-purpose plane served the US Navy and Air Force as both a fighter and a strike fighter throughout the 1960s and early 1970s. In the USAF it is now obsolescent, serving mainly for reconnaissance and electronic warfare ("Wild Weasel"). However, hundreds were sold to western nations worldwide, including Iran under the Shah. For air-to-air combat the plane can carry four AIM-9 Sidewinders and four AIM-7 Sparrows.

F-5E Tiger II

Designer/Manufacturer: Northrop, USA

Role: Fighter & strike fighter

Crew: One

Mission Weight at Takeoff: 12 tons

Engine(s): Two General Electric J85-GE-21B turbojets for 10,000 lbs thrust

Range: 220 kilometers

Ceiling: 51,000'

Maximum Speed at 0': Not available, probably 500-600 kts
Maximum Speed at 36,000': 950 kts
Armament: Two 20mm cannon, 5 weapon pylons
Air-to-Air Radar Quality: Poor quality and range pulse radar
Maneuverability: Fair

Notes: This inexpensive and unsophisticated fighter was never adopted by US combat arms, but has been widely sold abroad, including 138 to Iran. Underpowered, with poor avionics, it is useful only against obsolete opponents. It can carry AIM-9 Sidewinders, but not AIM-7 Sparrows.

F-5E Tiger II

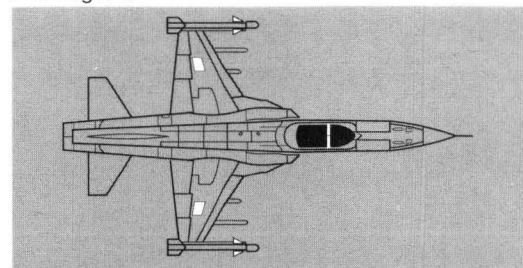

Designer/Manufacturer: Grumman, USA

Role: Fighter & interceptor

Crew: Two

Mission Weight at Takeoff: 35 tons

Engine(s): originally two Pratt & Whitney TF30-412A turbofans for 41,800 lbs thrust, upgraded in D model to two General Electric F110-400 turbofans for 54-58,000 lbs thrust

Range: 1280 kilometers

Ceiling: over 56,000'

Maximum Speed at 0': 800 kts with TF30, higher with F110

Maximum Speed at 36,000': 1350 kts with TF30, higher with F110

Armament: 6-barrel 20mm cannon, 4 weapons pallets, 2 weapons pylons

Air-to-Air Radar Quality: Excellent range, high quality doppler radar

Maneuverability: Good

Notes: This heavy, long-range interceptor has extremely powerful avionics for use with the AIM-54 Phoenix semi-active radar-homing missile, which has a 200 km effective range. The aircraft is the US Navy's long-range defender of carrier battle groups. Standard USN armament is four Phoenix and four Sidewinder missiles (two per pylon). The swinging wings are computer controlled for maximum performance, but their swing also shows the plane's energy state to the enemy. In 1987 the Navy began a program that upgraded the original TF30 engines with the newer, more powerful F110s. About 80 TF30-engined F14s were supplied to Iran, but engine troubles, complexities in the avionics system, and the delicacy of the Phoenix missiles have greatly reduced their military value. They are often used as radar-warning patrol aircraft.

F-14D Tomcat

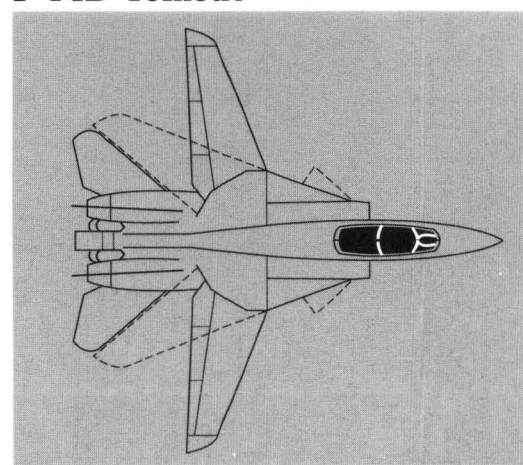

Designer/Manufacturer: McDonnell Douglas, USA

Role: Fighter

Crew: One

Mission Weight at Takeoff: 22 tons

Engine(s): Two Pratt & Whitney F100-100 turbofans for 47,660 lbs thrust

Range: 1200 kilometers

F-15C Eagle

F-15C Eagle

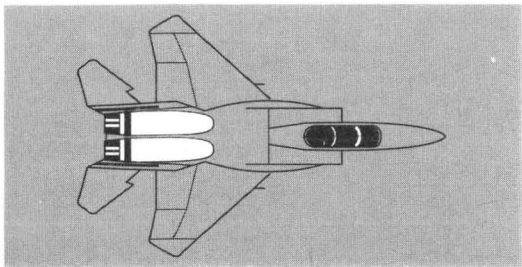

Ceiling: 63,000'
Maximum Speed at 0': 810 kts
Maximum Speed at 36,000': 1260 kts or greater
Armament: 6-barrel 20mm cannon, 4 missile ejectors, 4 weapons pylons, 2 FAST pallet points
Air-to-Air Radar Quality: Medium range, high quality doppler radar
Maneuverability: Very good
Notes: This large, powerful dogfighter is the dream plane of many USAF pilots. Although not as nimble as the lightweight F-16, it has longer ranged avionics, plus a brute size and power unmatched by any fighter until the new Russian Su-27 appeared.

F-16C Falcon

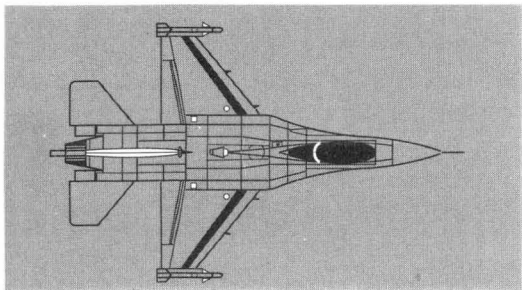

Designer/Manufacturer: General Dynamics, USA
Role: Fighter & strike fighter
Crew: One Pratt & Whitney F100-200 turbofan for 23,830 lbs thrust
Mission Weight at Takeoff: 12.5 tons
Engine(s): One
Range: 540 kilometers
Ceiling: over 50,000'
Maximum Speed at 0': 800 kts
Maximum Speed at 36,000': 1190 kts
Armament: 6-barrel 20mm cannon, 7 weapon pylons
Air-to-Air Radar Quality: Medium range, high quality doppler radar
Maneuverability: Excellent
Notes: The latest production fighter added to the US Air Force, the F-16 is the most maneuverable dogfighter in the world (possibly excepting the MiG-29). The inherently unstable airframe that gives this agility would be unflyable except for the computerized electronic controls, hence its nickname "Electric Jet". Advanced air-ground avionics and anti-missile defenses are "extras", making the basic aircraft relatively cheap. Many western nations have purchased F-16s. However, until the AIM-120 AMRAAM it had no long-range AAM.

F/A-18A Hornet

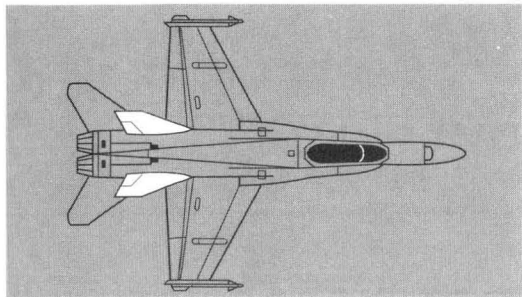

Designer/Manufacturer: McDonnell Douglas/Northrop, USA
Role: Fighter & strike fighter
Crew: One
Mission Weight at Takeoff: 18 tons
Engine(s): Two General Electric F404-400 turbofans for 32,000 lbs thrust
Range: 740 kilometers
Ceiling: 50,000'
Maximum Speed at 0': less than 660 kts
Maximum Speed at 36,000': 1050 kts
Armament: 6-barrel 20mm cannon, 9 weapons pylons
Air-to-Air Radar Quality: Medium range, high quality doppler radar
Maneuverability: Good to very good

Notes: Although not as maneuverable as the F-16, this heavier multi-role fighter has numerous avionic and defensive aids built in. These were required by the US Navy, its main user, who needed an all-purpose fighter and attack bomber able to fire a variety of sophisticated weapons. Like the F-16, it also is sold to various western nations.

Designer/Manufacturer: Grumman, USA

Role: Attack & interdiction bomber

Crew: Two

Mission Weight at Takeoff: 13 tons

Engine(s): Two Pratt & Whitney J52-8A turbojets for 18,600 lbs thrust

Range: 870 kilometers

Ceiling: 44,600'

Maximum Speed at 0': 570 kts

Maximum Speed at 36,000': 540 kts

Armament: 5 weapons pylons

Air-to-Air Radar Quality: Poor, but superb air-to-ground weapons radars

Maneuverability: Fair to poor

Notes: Designed at the end of the 1950s as a low-level attack bomber for use in bad weather or at night, this plane remains an unqualified success. Avionics and weapons have been rebuilt more than once to maintain the "state of the art", with upgrades under development. Electronic warfare (EA-6 and EA-6B) and aerial tanker (KA-6D) versions exist.

Designer/Manufacturer: British Aerospace, UK (original design) and McDonnell Douglas, USA (American version)

Role: S/VTOL Fighter & strike fighter

Crew: One

Mission Weight at Takeoff: 15 tons STOVL, 10 tons VTOL

Engine(s): One Rolls Royce/Pegasus 11-21E for 22,000 lbs vectored thrust (no afterburner)

Range: 240 kilometers

Ceiling: 55,000'

Maximum Speed at 0': 585 kts

Maximum Speed at 36,000': 520 kts

Armament: one 25mm cannon, 7 weapon pylons

Air-to-Air Radar Quality: Poor, target acquisition is usually visual

Maneuverability: Very good

Notes: Originally designed as a strike fighter, the American-British co-design greatly enhanced maneuverability. The avionics are designed for ground attack rather than air-to-air combat. Despite this, Harriers were successful as interceptors and combat air patrol in the 1982 Falklands war. The Harrier is the primary fighter of the US Marines, the British Royal Navy, and frontline squadrons of the British Royal Air Force (RAF) in Germany. Usually it

A-6E Intruder

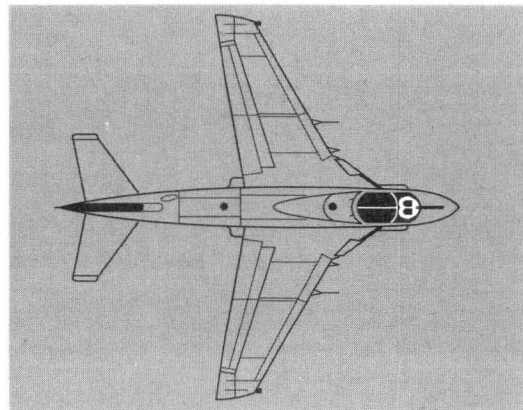

AV-8B Harrier II

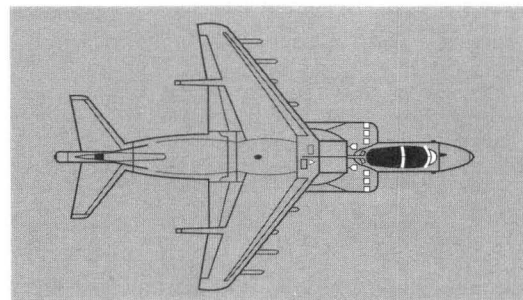

uses short segments of roadway or a "ski-jump" deck for rolling takeoffs, and later lands vertically, like a helicopter.

A-10A Thunderbolt II

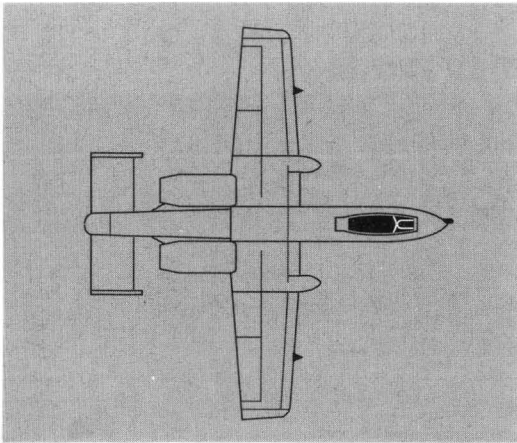

Designer/Manufacturer: Fairchild Republic, USA

Role: Close support aircraft

Crew: One

Mission Weight at Takeoff: 20 tons

Engine(s): Two General Electric TF34-100 turbofans for 18,130 lbs thrust

Range: 960 kilometers

Ceiling: probably under 40,000'

Maximum Speed at 0': 370 kts

Maximum Speed at 36,000': Unknown, probably less than 370 kts

Armament: 7-barrel 30mm cannon, 11 weapon pylons

Air-to-Air Radar Quality: Poor, air-to-ground avionics quite basic

Maneuverability: Very good

Notes: This slow, heavily armored plane was designed purely for frontline ground attack with "tank busting" its speciality. This role (unglamorous to the USAF), along with its peculiar appearance, earns it the unofficial nickname "Warthog". Although intended for combat in Europe where low clouds and bad weather are frequent, the A-10 is a fair-weather day-only plane. The manufacturer hopes to interest the USAF in a night-flying variant, currently without success. Unless protected by good fighters (F-15s and F-16s), this plane is doomed if sent into airspace contested by USSR fighters.

EF-111A Raven

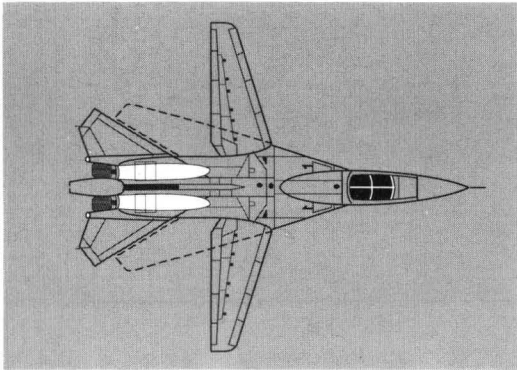

Designer/Manufacturer: General Dynamics, USA

Role: Electronic warfare escort

Crew: Two

Mission Weight at Takeoff: 43.5 tons

Engine(s): Two Pratt & Whitney TF30-3 turbofans for 37,000 lbs thrust (with afterburners)

Range: 1,900 kilometers

Ceiling: 54,700'

Maximum Speed at 0': 700 kts

Maximum Speed at 36,000': 1020 kts

Armament: ALQ-99E electronic warfare system, no other weapons

Air-to-Air Radar Quality: Medium-long range, high quality pulse & doppler

Maneuverability: Fair

Notes: This is a specially built electronic warfare version of the F-111 strike and interdiction bomber. The original concept of the F-111 was a high-speed bomber for deep strikes at high and/or low altitude, especially at night or in bad weather. The EF-111 is popularly known as the "Electric Fox" or "Spark Vark" (the unofficial nickname of the F-111 is "Aardvark" or "Vark"). It is designed to accompany deep strike and interdiction missions, providing electronic screening and jamming. It is the fastest, most powerful such craft in the world.

Designer/Manufacturer: Rockwell International, USA

Role: Strategic bomber

Crew: Four

Mission Weight at Takeoff: 225 tons with internal load only

Engine(s): Four General Electric F101-102 turbofans for 120,000 lbs thrust

Range: 5,900 kilometers

Ceiling: Unknown, probably under 50,000'

Maximum Speed at 0': 530 kts

Maximum Speed at 36,000': 725 kts

Armament: 37.5 ton capacity bomb bay, 29.5 tons additional on external mounts if desired

Air-to-Air Radar Quality: Medium range, high quality doppler radar

Maneuverability: Poor

Notes: This redesign of the B-1A (cancelled in the late 1960s) emphasizes low-level attack and minimal radar signature. The aircraft is now seriously overloaded by the numerous revisions and often unreliable electronic defensive gear. Despite the usual carping from the US press, in combat against first-line Russian aircraft this bomber has some hope of survival. The obsolescent B-52s it replaces would have no chance whatsoever.

Designer/Manufacturer: Boeing, USA

Role: Airborne Early Warning & Control

Crew: 15 to 17

Mission Weight at Takeoff: 162.5 tons

Engine(s): Four Pratt & Whitney TF33-100/100A turbofans for 84,000 lbs thrust

Range: 3,000 kilometers (11 hours unrefueled endurance)

Ceiling: over 29,000'

Cruise Speed at Altitude: over 350 kts

Maximum Speed at Altitude: 460 kts

Armament: Surveillance radar, communications, air traffic control, and electronic defenses; weapons pylons may be added.

Air-to-Air Radar Quality: Excellent range and quality radars.

Maneuverability: Poor

Notes: This 707 airliner frame holds the most sophisticated and effective airborne radar in the world. No other nation has a plane of equivalent effectiveness (the British Nimrod and Russian Moss are failures, the new Russian Mainstay is still unproven). Flying "racetrack" circles behind friendly lines at 25-30,000', this AWACS can watch and direct aircraft out to 300 miles range. Until the "C" model upgrade, too many aircraft and limited computer power caused temporary "blind spots". In wartime weapons pylons carrying AIM-9 Sidewinders or AIM-120 AMRAAMS could be added. In addition each Sentry carries various electronic defenses and always has a fighter escort.

B-1B Bomber

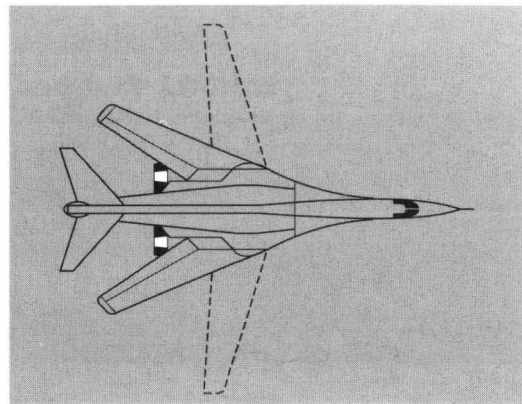

E-3C Sentry "AWACS"

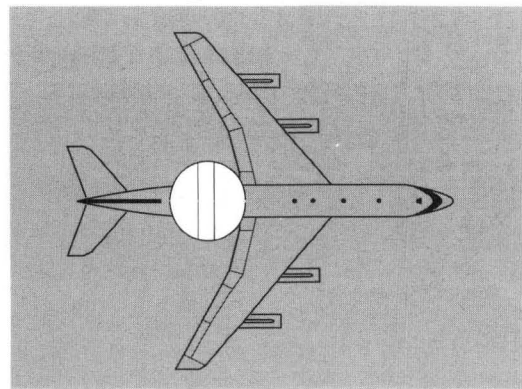

Russian-Built Warplanes

MiG-21 Fishbed

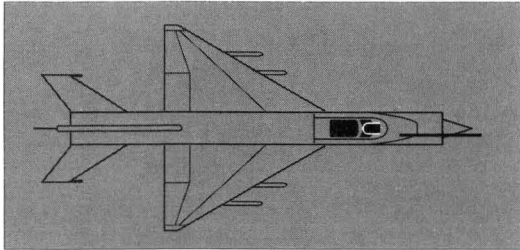

Designer/Manufacturer: Mikoyan-Gurevich, USSR

Role: Fighter

Crew: one

Mission Weight at Takeoff: 9 tons

Engine(s): One Tumansky R-11F2S-300 turbofan for 14,550 lbs thrust

Range: 630 kilometers

Ceiling: 59,000' (often only 50,000')

Maximum Speed at 0': 700 kts

Maximum Speed at 36,000': 1220 kts

Armament: Two 23mm cannon, 4 weapons pylons, 1 fuel tank pylon

Air-to-Air Radar Quality: Very short range, low quality pulse radar

Maneuverability: Good

Notes: This agile, maneuverable, easy-flying fighter was the premier dogfighting plane of the 1960s and early 1970s. It has simple avionics and a standard armament of 2 or 4 AA-2s (now often replaced by AA-8s), making it inexpensive to buy, arm and maintain. However, it has little or no HUD, weak radars, and low quality defenses, making it obsolete as a fighter. Unfortunately, its limited carrying capacity makes it poor as a strike fighter.

MiG-23 Flogger

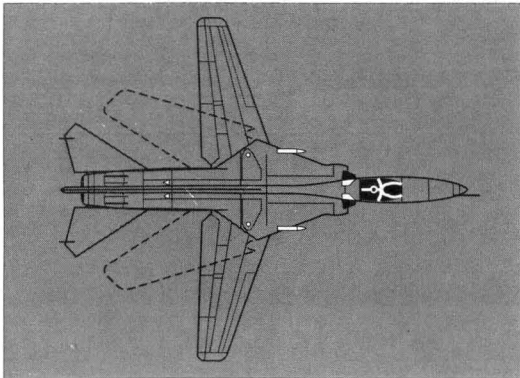

Designer/Manufacturer: Mikoyan-Gurevich, USSR

Role: Fighter

Crew: One

Mission Weight at Takeoff: 16 tons

Engine(s): One Tumansky R-29B turbofan for 27,500 lbs thrust

Range: 900 kilometers

Ceiling: 61,000'

Maximum Speed at 0': 740 kts

Maximum Speed at 36,000': 1190 kts

Armament: Two 23mm cannon, 4 weapon pylons, 1 fuel tank pylon

Air-to-Air Radar Quality: Very poor, short range range pulse radar

Maneuverability: Fair

Notes: This swing-wing fighter replacement for the MiG-21 originally had few avionics and a 22,485 lb. R-27 engine. This variant, incapable of firing sophisticated weapons and with serious performance flaws, is often sold abroad. The more advanced models, listed above, are mediocre performers. All commonly carry AA-2 and/or AA-8 missiles, most USSR and East European versions use the AA-7 radar homing missile also. With its MiG-27 brother, this plane has huge production runs, making it the cheapest fighter available today. This alone makes it one of the world's most popular aircraft.

[Physical appearance equivalent to MiG-23]

Designer/Manufacturer: Mikoyan-Gurevich, USSR

Role: Strike Fighter

Crew: One

Mission Weight at Takeoff: 22 tons

Engine(s): One Tumansky R-29 turbofan for 25,353 lbs thrust

Range: 400 kilometers

Ceiling: 52,500'

Maximum Speed at 0': 635 kts

Maximum Speed at 36,000': 925 kts

Armament: One 6-barrel 23mm cannon, 5 weapon pylons, 2 bomb racks

Air-to-Air Radar Quality: Very poor, very short range pulse radar

Maneuverability: Fair

Notes: This is the ground-attack variant of the MiG-23. In Russian frontline units it includes a laser designator for laser-guided munitions and simple terrain-avoidance radars for low-level attacks. Improved jammers and decoys are added as well. However, many sophisticated attack aids common on western strike fighters are not present. Presumably the MiG-27s compensate for this with quantity, as huge production runs greatly lower its cost.

Designer/Manufacturer: Mikoyan-Gurevich, USSR

Role: PVO Interceptor

Crew: One

Mission Weight at Takeoff: 40 tons

Engine(s): Two Tumansky R-31 turbofans for 48,500 lbs thrust

Range: 1,100 kilometers

Ceiling: 80,000'

Maximum Speed at 0': 570 kts

Maximum Speed at 36,000': 1860 kts

Armament: 4 weapons pylons

Air-to-Air Radar Quality: Medium quality, medium range pulse radar

Maneuverability: Poor

Notes: This plane was originally designed to defend the distant borders of the USSR from air attack, working with special ground radars to attack enemy bombers with a special long-ranged AAM (the AA-6). It is extremely fast, but quite unmaneuverable. A few are bought by client states for status reasons, but the reconnaissance version (MiG-25R) is more popular — its 88,000' ceiling makes it immune to normal SAM or fighter interception.

Designer/Manufacturer: Mikoyan-Gurevich, USSR

Role: Fighter

Crew: One

Mission Weight at Takeoff: 18 tons

Engine(s): Two Tumansky R-33D turbofans for 36,600 lbs thrust

MiG-27 Flogger

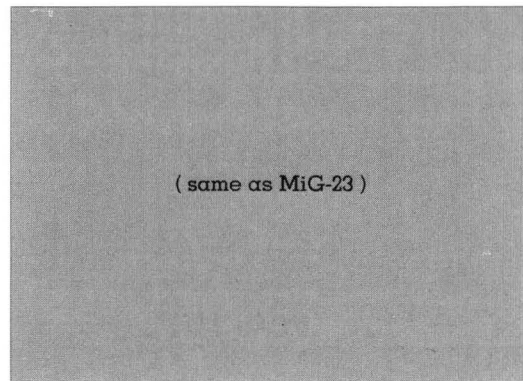

MiG-25 Foxbat

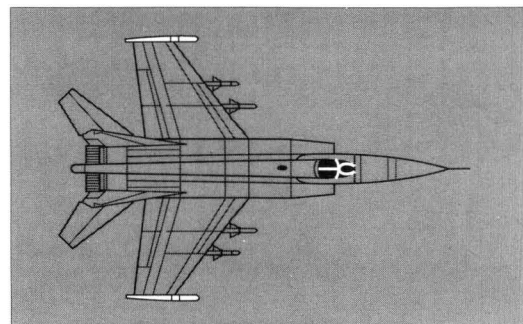

MiG-29 Fulcrum

MiG-29 Fulcrum

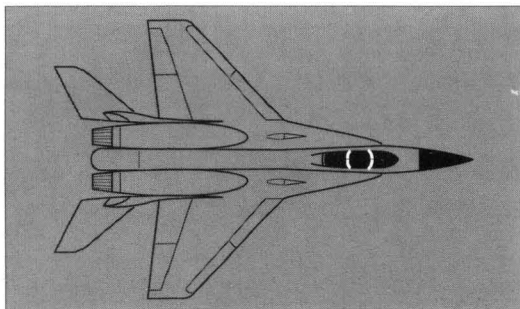

Range: 650 kilometers

Ceiling: Probably 55-65,000'

Maximum Speed at 0': 700 kts

Maximum Speed at 36,000': 1260 kts

Armament: One multi-barrel cannon, 6 weapons pylons

Air-to-Air Radar Quality: Medium quality and range doppler radar

Maneuverability: Very good to excellent

Notes: Originally designed to outfight the F-15, this plane is a modern, lightweight dogfighter with superlative agility. It has engine power in excess of its weight. Common armament is AA-10 "fire and forget" radar-homers along with some AA-8 and/or AA-10 IR missiles. The degree of sophistication in the avionics is unknown, but unlikely to match western models. Considerable debate exists regarding the relative superiority of this plane versus the F-16.

MiG-31 Foxhound

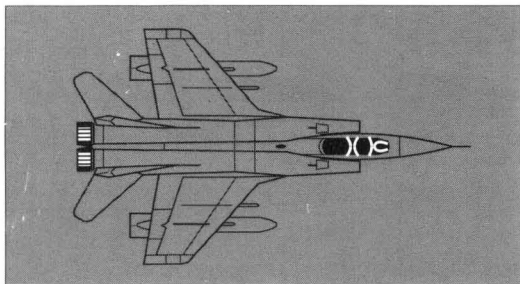

Designer/Manufacturer: Mikoyan-Gurevich, USSR

Role: PVO Interceptor

Crew: One

Mission Weight at Takeoff: 45 tons

Engine(s): Two turbofans or turbojets, estimated thrust 50-60,000 lbs

Range: 1,500 kilometers

Ceiling: 75,500'

Maximum Speed at 0': 790 kts

Maximum Speed at 36,000': 1400 kts

Armament: Cannon possible, 4 missile recesses, 4 weapons pylons

Air-to-Air Radar Quality: Superior quality and range doppler radar

Maneuverability: Fair

Notes: This aircraft is a redesigned MiG-25. Although slightly slower, it is improved in all other categories, especially low-altitude interceptions against planes and cruise missiles. The new AA-9 long-range missile is designed for look-down attacks on low-level cruise missiles. It also has AA-8s and AA-10s.

Su-24 Fencer

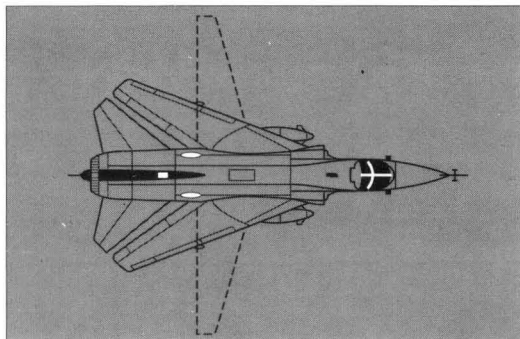

Designer/Manufacturer: Sukhoi, USSR

Role: Strike Fighter & Interdictor

Crew: Two

Mission Weight at Takeoff: 43.5 tons

Engine(s): Two Tumansky R-29B turbofans for 50,700 lbs thrust

Range: 300 to 1,800 kilometers (varies with mission profile and load)

Ceiling: 57,400'

Maximum Speed at 0': 765 kts

Maximum Speed at 36,000': 1400 kts

Armament: 6-barrel 23mm cannon, 8 weapon pylons

Air-to-Air Radar Quality: nil, avionics designed purely for air-ground role

Maneuverability: Fair

Notes: This is the most advanced air-ground attack plane built by the USSR. Externally it appears similar to the F-111, including the side-by-side

seating in the cockpit. However, its armament and avionics are designed for front-line and rear-area strikes, into the teeth of enemy air defenses. Western air and ground commanders fear the Su-24 more than any other Soviet aircraft. The aircraft may carry a few AA-8s for self-defense, but it is not designed for air-to-air combat.

Designer/Manufacturer: Sukhoi, USSR

Role: Fighter

Crew: One

Mission Weight at Takeoff: 25 tons

Engine(s): Two unknown turbojets for estimated 60,000 lbs thrust

Range: 1,150 kilometers

Ceiling: Unknown, probably 60,000' or more

Maximum Speed at 0': 725 kts

Maximum Speed at 36,000': 1350 kts

Armament: Probably a cannon, 6 weapons pylons

Air-to-Air Radar Quality: Above average quality and range doppler radar

Maneuverability: Very good to excellent

Notes: This aircraft was designed to defeat the F-14 and F-15 fighters. It is a large, powerful dogfighter whose usual armament is probably four AA-8 and four AA-10 missiles. In comparison to the MiG-29, the Su-27 is a larger, heavier plane. If its avionics and flight controls are truly modern, the Su-27 may be the superior plane. However, in dogfighting maneuverability the MiG-29 and F-16 probably have the edge.

Designer/Manufacturer: Yakovlev, USSR

Role: VTOL Fighter

Crew: One

Mission Weight at Takeoff: 12 tons

Engine(s): One Lyulka AL-21 vectored-thrust turbojet for 17,985 lbs thrust (no afterburner), plus two Koliesov liftjet engines

Range: 370 kilometers

Ceiling: 39,370'

Maximum Speed at 0': 535 kts

Maximum Speed at 36,000': 550 kts

Armament: 4 weapons pylons

Air-to-Air Radar Quality: Poor quality and range pulse radar

Maneuverability: Fair

Notes: Originally known as the Yak-36MP, this vertical take-off fighter operates from the Kiev-class aircraft carriers. These lack the equipment and deck space for conventional jets. Initially thought to be a Russian equivalent of the Harrier, the Yak-38 is considerably inferior. It has limited interception ability and very limited strike capacity. However, until this plane the Russian navy had nothing bigger than helicopters for its warships at sea.

Su-27 Flanker

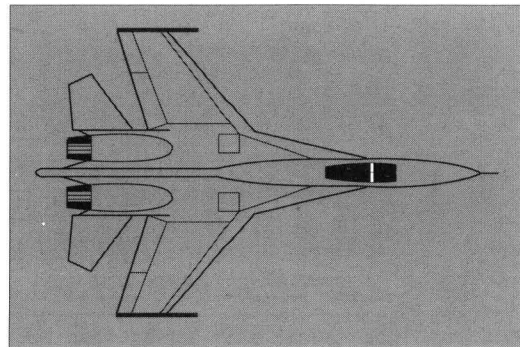

Yak-38 Forger

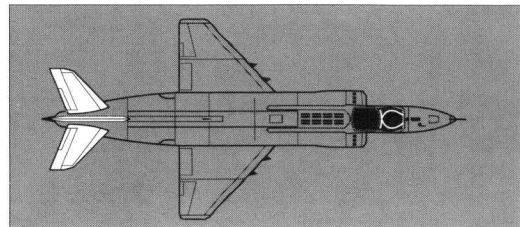

Tu-26 Backfire

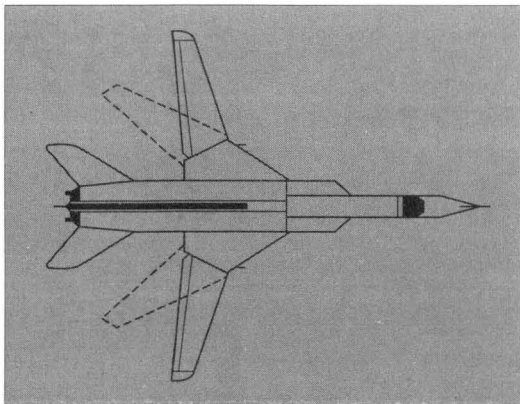

Designer/Manufacturer: Tupolev, USSR

Role: Bomber

Crew: Four

Mission Weight at Takeoff: 61 tons

Engine(s): Two uprated Kuznetsov NK-144 turbofans for 88,180 lbs thrust

Range: 5,500 kilometers

Ceiling: 55,000'

Maximum Speed at 0': 525 kts

Maximum Speed at 36,000': 970 kts

Armament: Three heavy Air-Surface missiles or 13 tons of bombs

Air-to-Air Radar Quality: Fair, with excellent air-to-surface avionics

Maneuverability: Very poor

Notes: Many of these swing-wing bombers are in service with the Soviet naval-air arm, carrying long-range missiles to attack hostile warships up to 3,000 kilometers out to sea. The Backfire's exceptionally long range and high speed, plus its powerful missiles make it a mortal threat to USN aircraft carriers. With aerial refueling it has sufficient range to get within cruise-missile-launch position of the USA. As a gesture to arms control, the USSR has removed air refueling equipment from its Air Force Backfires.

Tu-95D Bear

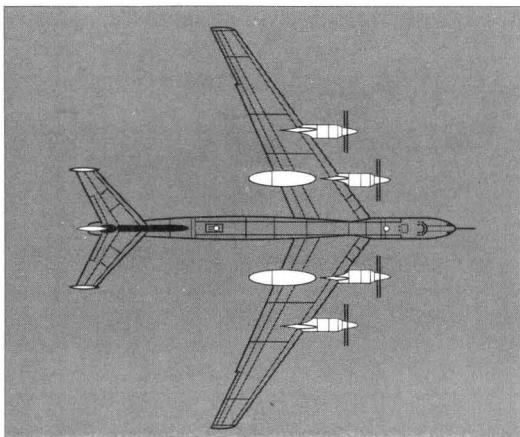

Designer/Manufacturer: Tupolev, USSR

Role: Reconnaissance bomber

Crew: 7-12

Mission Weight at Takeoff: unknown, about 145-165 tons

Engine(s): four Kuznetsov NK-12MV turboprops

Range: 8,250 kilometers (7 hours endurance)

Ceiling: 41,000'

Maximum Speed at 0': 410 kts

Maximum Speed at 36,000': 475 kts

Armament: Unarmed

Air-to-Air Radar Quality: Very good long-radar pulse radars

Maneuverability: Terrible

Notes: The Tu-95 has been the world's most sophisticated turboprop bomber for over thirty years (it entered service in 1955). It is primarily used for long-range reconnaissance, electronic intelligence, electronic warfare (jamming), anti-ship missiles, and cruise-missiles. The "D" model is a reconnaissance version, the "H" model (on a slightly modified airframe) a cruise-missile carrier.

Designer/Manufacturer: Ilyushin, USSR

Role: Airborne Early Warning & Control (AEW&C)

Crew: Estimated at 15 to 20

Mission Weight at Takeoff: About 150 tons

Engine(s): four Soloviev D-30KP turboprops for 106,000 lbs thrust

Range: About 6,400 kilometers (7 hours endurance)

Ceiling: About 40-50,000'

Maximum Speed at 0': 400 kts

Maximum Speed at 36,000': 460 kts

Armament: Possibly twin 23mm tail cannon, 2-4 weapons pylons

Air-to-Air Radar Quality: Excellent long-radar doppler radars

Maneuverability: Terrible

Notes: The "Mainstay" is a conversion of the huge Il-76 Candid transport plane to "AWACS" duties. Its purpose is to detect enemy aircraft and low-flying missiles, and act as a mobile, airborne command post that controls friendly aircraft engaging such threats. The earlier Tu-126 "Moss" AEW&C with turbo-props was a disastrous failure. Like many AEW&C planes, the Il-76 could carry a few AAMs (AA-8s or AA-10s) for self defense, as well as extensive jammers, decoys, etc.

Designer/Manufacturer: Antonov, USSR

Role: Air transport

Crew: 3

Mission Weight at Takeoff: 28 tons

Engine(s): Two Lotarev D-36 turboprops for 28,660 lbs thrust

Range: 1000 kilometers (max cargo) to 3,800 kilometers (no cargo)

Ceiling: 36,100'

Maximum Speed at 0': 350 kts

Maximum Speed at 36,000': 410 kts

Armament: unarmed; can carry 32 passengers or 11 tons cargo

Air-to-Air Radar Quality: Navigational only

Maneuverability: Terrible for a fighter, but good for a transport

Notes: This is the latest general-purpose medium air transport of the Soviet Union. Its jet engines and short-takeoff performance make it an outstanding utility craft for transporting all types of personnel and cargo between remote airfields.

Il-76 Mainstay

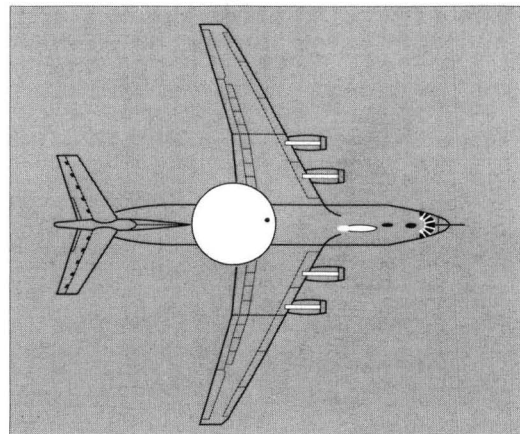

An-72 Coaler

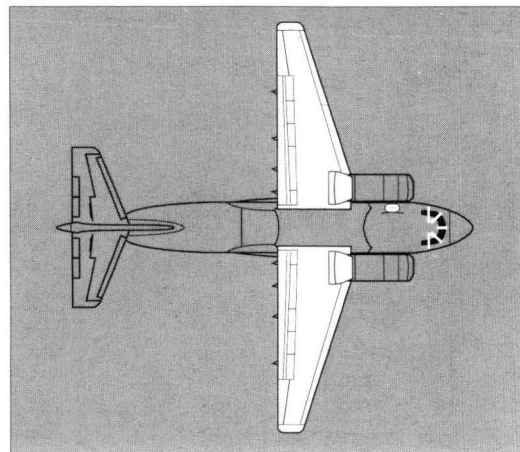

APPENDIX

Glossary

AAM: Air-to-air missile.

Ace: Pilot with five or more confirmed kills of enemy aircraft.

Ace-of-the-Base: Best flyer in the squadron.

AFV: Armored Fighting Vehicle, an armored vehicle designed for front line combat. This includes tanks, armored personnel carriers, anti-aircraft tanks, SAM missile carriers, etc.

AGM: Air-to-Ground Missile. Originally used by the US Air Force for missiles designed to hit land surface targets, but commonly extended to mean missiles designed for use against land or sea targets.

ARM: Anti-radiation Missile. Missile designed to home on enemy radar sets.

ASM: Air-to-Surface Missile. Often used for missiles designed to attack ships, but sometimes generalized to mean any missile launched against targets on the surface of the earth.

Bravo Sierra: Military words for BS, which in turn is an abbreviation for a common expletive, here indicating something especially unpleasant or unbelievable. For example: "Doing the bunny hop down the runway to a belly-flop landing, then complaining about wind sheer, is true Bravo Sierra!"

BVR: Beyond Visual Range. Any engagement where you cannot visually distinguish the target. During peacetime pilots are often prohibited from firing BVR, for fear of hitting the wrong target.

CAP: Combat Air Patrol. Aircraft patrolling over friendly forces. Originally it meant fighters launched from aircraft carriers, and assigned to patrol over those carriers, protecting them from air attack.

Check your Six: Watch your tail; literally, watch the six o'clock position of your aircraft.

Colors: Silk neck scarf worn by fighter pilots.

Ditch: Bail out, esp. over water.

Driver: Pilot.

ECM: Electronic Counter-measures. Devices designed to jam or fool ("spoof") enemy electronic sensors, notably radar.

ECCM: Electronic Counter-counter-measures. Devices designed to protect against jamming or "spoofing" by enemy ECM.

Electric Jet: F-16 Falcon.

Fangs Out: Seeking air-to-air victory in a dogfight, regardless of other dangers or considerations, such as worry about other enemy aircraft, your EMV, or even your altitude. See Knife Fight.

FEBA: Forward Edge of the Battle Area. Older NATO abbreviation for the front line or battle line with the enemy.

FitRep: Fitness Report. A report by commander that recommends subordinates for promotion (or not, as appropriate).

FLOT: Forward Line of Troops. Current NATO abbreviation for the front line or battle line with the enemy.

Flying a Desk: Staff or command job with no flying duties.

Frisbee: Unofficial nickname of the F-19 Stealth Fighter.

HUD: Head-Up Display. A large piece of glass mounted on the cockpit front, arranged so a pilot can look forward through the glass. All crucial (i.e., "real time") information is projected onto the glass, so the pilot can watch the outside while getting detailed information. Some HUDs have become so complex they defeat their designed purpose (and are equipped with a "de-clutter" switch!).

Knife Fight: Dogfight to the death — what happens when you go "fangs out." This situation is advantageous to low-speed, highly maneuverable planes and disadvantageous to higher speed but less maneuverable planes. However, either or both contestants can be surprised by other fighters and SAMs.

ILS: Instrument Landing System. A device that receives signals from an airport and displays to the pilot his position in relationship to a hypothetical glide path.

INS: Inertial Navigation System. A device that keeps track of an airplane's position (using a gyroscope) and displays that position and a desired destination. There are many different types of INS systems; those which use cockpit CRT maps and HUD pointers are the most sophisticated.

IR: Infrared. A portion of the electro-magnetic spectrum where the intensity of the signal is directly related to the heat of the object.

Mike Mike: Military words for "mm", generally referring to 20mm cannon shells. Ex: "Then I placed some Mike Mike right up his tail".

MiG: Mikoyan-Gurevich design bureau, which specializes in the design and construction of jet fighters for the Soviet Union. Often used as a generic name for all Soviet-built fighter aircraft (even though other bureaus contribute fighter designs).

Niner: Reference to the AIM-9 Sidewinder missile. The 9L version is known as the "Niner Lima", the 9M version used by the F-19 is a "Niner Mike".

Obsolescent: Outdated but not yet useless; not quite obsolete.

Promo: Promotion.

Pucker Factor: Level of fear (e.g., "When those 20 Flankers jumped us, the pucker factor sure went up!").

Punch His Ticket: To shoot down an enemy fighter plane.

Punch Out: Specifically to bail out using an ejection seat, but generally applied to a departure ("Let's punch out of here!").

SAM: Surface-to-Air Missile.

Sierra Hotel: Military expansion of the letters "SH", here an abbreviation for heated excrement. Curiously, the expression denotes admiration and excitement. For example, "Sierra Hotel, look at that guy smoke MiGs!".

Skunk Works: Quasi-official nickname of the Lockheed plant in Burbank, California that designs and builds top-secret aircraft.

Smoke: To destroy, as in "Smoked that Mig!". Originally from the smoke plume emitted by burning aircraft as they fall to earth.

Star: As in, "getting your star." Refers to the much coveted promotion from Colonel to General, where your rank insignia is now a single gold star.

VVI: Vertical Velocity Indicator. A gauge that indicates how fast a plane is ascending or descending.

Whiskey Delta: Military expansion of the letters WD, which in turn refers to weakness in a certain male organ rarely discussed in polite company. The term is an especially derogatory and insulting description of a fighter pilot (e.g., "that Whiskey Delta couldn't even find his own airbase, much less hit it with a bomb.").

Wing Weenie: Administrative staff officer attached to a fighter unit, but with no combat or flying duties. A mildly derogatory term.

Zero-Zero: Nickname for the zero-zero type ejection seat. So named because, in theory, a pilot can eject safely from a plane with zero speed and zero altitude (i.e., sitting on a runway).

Notes

Designers' Notes

The Concept

MicroProse's fame and reputation have come from military flight simulators, especially the classic *F-15 Strike Eagle*, first published in 1984. Since that date we've released many novel and popular products (*Silent Service*, *Pirates*, *Airborne Ranger*), but only one combat flight simulator, *Gunship*, and that about a helicopter (the AH-64A Apache). In the meantime, flight simulators have suddenly become popular, with almost every software publisher scrambling onto the bandwagon.

Clearly, it was time for us to create a new military aircraft simulator, a state-of-the-art product that showed what "flight simulator experts" could do. For this we selected the F-19 "Frisbee" Stealth Fighter. Although the plane is both conjectural and highly classified, it is the ideal subject for a one-man/one-plane/one-mission situation. Modern air attacks are usually a complex dance of many different machines, each with a unique specialty and role — the scouts, the electronic warfare escorts, the strike planes, the fighter cover, and the AWACS airborne controllers. The F-19 is the exception: it flies alone, relying on stealth and subtlety instead of brute force. Not since 1916 have fighter pilots gone off alone to duel the enemy. Now that bygone era of the lone wolf hero is possible again, in a very modern, high-tech environment.

The Design

Our first "new generation" jet simulator appeared in late 1987, for the Commodore C64/C128. Originally titled "Project: Stealth Fighter", it was an impressive, ground-breaking achievement for 8-bit, 1 MHz, 64K computers. However, the 3-D graphics technology in that simulator was customized to its limited environment. The 16-bit, 4.77 to 25 MHz computers with 384K or more required an entirely new programming approach. Our experience with earlier flight simulators, including *Gunship*, was a tremendous help in deciding what to do, and what not to do.

When you look at a flight simulator, the first thing to check is the detail and fidelity of the "3-D" out-the-cockpit graphics. Many "simulators" use arcade-style sprite graphics. They move a picture of the object around the screen. There are two or three (or four, or whatever) sizes of each picture, to give the impression of depth; but it's still really a two-dimensional cardboard cutout sliding around the screen. In comparison, a true simulator like F-19 Stealth Fighter has a data record of each object's dimensions, and then adjusts it for distance and viewing angle, as well as removing objects hidden behind others. We also add a scaling adjustment to compensate for the "coarseness" of a computer screen. This is because the human eye can see tiny forms and shapes that are rendered as a dot on screen. To achieve all this on a microcomputer you must make constant trade-offs between speed and detail.

You'll notice that this program automatically adjusts itself to the speed of

your computer. Regardless of whether your processor is a 4.77 MHz 8088 or a 25 MHz 80386, the simulation moves at the same real-time speed. The only changes are in the smoothness and detail of the 3-D out-the-cockpit graphics. You can even change the smoothness/detail tradeoffs we selected with the *Detail Adjust* key.

It's quite possible to create a technically impressive and factually accurate simulation, that is nonetheless a turkey. We don't allow that at MicroProse. The experience of flying the simulation, the "game play" (if you insist on viewing this as a game) must be enjoyable and interesting. We spend a great deal of time on the "feel" of the flight controls, organizing the worlds you fly in, the changing radar environment, the skill of enemy pilots, enemy reaction times, and much more.

All this realism in a flight simulator must still have a purpose. In our case, the purpose is playable, enjoyable situations. Who wants a simulator that kills you unless you've logged thousands of hours of flying? We want more than accurate missile ranges or realistic Paveway attack profiles. We also want an endless supply of new missions, situations, and opponents. We want the enemy to behave logically and rationally in these new situations. We want you to have new problems and new opportunities, with every mission. Furthermore, we're willing to spend the time and effort needed. However, we try to make things easy to learn and use. After all, what good are fifty zillion software features if you can't find them? So we insisted on including maps and keyboard overlays.

Some of our customers have asked for specific program data, especially scoring data. Unfortunately, while boardgames present this in simple tables or lists, we use more complicated techniques. In fact, the scoring logic is so complicated that we wrote a separate "scoring tester" program just to check it. But the objective of this complexity is simple: don't fly the plane for the maximum point score. Instead, imagine yourself a real pilot, in a real situation, and act accordingly. The scoring is like your CO, rewarding your good judgement, and pointing out your mistakes!

Simulations such as *F-19 Stealth Fighter* require a large, talented creative team to produce. The 16-bit version was engineered by that now-famous team of Sid Meier (master of algorithms and data structures that recreate reality) and Andy Hollis (one of the hottest 3-D and assembly programmers in the nation).

Sid's the founding father of MicroProse (along with President "Wild Bill" Stealey), and brings a veteran viewpoint of game programming and game design. A large number of features in this product started with Sid saying, "Wouldn't it be neat if..." The neat part is that Sid then goes and implements the code that very day!

Andy is one of MicroProse's veterans, and has done fast, tight 3-D code before — in *C64 Gunship*, and then again in *IBM Gunship*. Each time Andy finds new ways to get more, faster, in less space. Andy isn't our only 3-D expert. For

The Design Team

example, he used some Scott Spanburg's secret and magical object logic, which Scott had just finished conjuring for another (future) MicroProse product. Andy's a great fan of high speed anywhere: in computers and in cars (he races autocross in his spare time).

Jim Synoski, creator of the original C64 Stealth Fighter, was dragged into this version to help out. He was nice about it, especially about all the things Sid changed! He worked with ace computer artist Max ("Maximum") Remington to create the entire preflight and postflight system. Even an "old guard" expert like Jim, veteran of many other MicroProse games, can be impressed (dressed?) by the complexity and detail involved in Briefings and Debriefings. The apparently limitless variety of IBM graphics modes (VGA, MCGA, EGA, CGA, Tandy and Hercules) doesn't help!

The 3D databases for the four "worlds" were created by game designer Bruce Shelley and artist Max Remington. It was here that "Maximum" got his nickname. For a while every object he created went right to the data space maximum, causing something new to "blow" in Andy's code, like an engine overrevving too far. Fortunately 3D graphic glitches are fairly obvious to a trained eye — all were spotted and eventually fixed. Bruce's job was more difficult. A veteran of many board wargame designs, he worked within the very complicated and often frustrating limitations of a microcomputer's data space layout. The remarkable fidelity of the data space world to the "real" world is a testament to his perseverance. Fortunately he was a good sport through it all, perhaps inspired by the 7:00 AM basketball games in the warehouse with 'Major Bill' and other B-ball fanatics within MicroProse.

All this data and graphics takes up a lot of room. In fact, *F-19 Stealth Fighter* on our development systems occupies about five megabytes (fifteen 360K floppy disks!). It's problems like these that David McKibbin was born to solve. His compression schemes "shrank" the code and data to its current size! Every time the disk drive loads something, it runs through a special "decompressor" that expands the code and/or data to "full size" in memory. This means you're getting a product that would otherwise require a hard disk and command a retail price well over \$100. So David's saving you a lot of cash as well as making *F-19* commercially viable.

The paper materials were conceived by designer Arnold Hendrick, author of this manual. Usually MicroProse's marketing department is concerned about the size, weight and cost of our manuals (not that it does any good, the manuals always go over budget). But for this product the word was, "go all out". Arnold took them at that, although they gulped hard when the page estimate jumped from 128 to 192! The rumor that marketing's office furniture was pawned to pay for the extra paper is entirely unfounded. Incidentally, the design, layout and artwork of the manual, maps and overlays were all done on computer with final output on Linotronic typesetters. In his alter ego as manager of the game design group, Arnold kibbitzed unmercifully about various aspects of the

design. Surprisingly, Sid, Andy, Jim and Bruce even took him seriously (at times).

Murray Taylor, 3-D artist extraordinaire, designed the basic "look" of this manual, executed the weapons illustrations, and did the six full-page computer pictures that grace these pages. How he finds time for the triathlon remains a mystery even within MicroProse.

Barbara Bents did yeoman (yeowoman?) work with the technical drawings, maps and keyboard overlays. MicroProse uses state-of-the-art drafting and layout software on MacII's for many internal graphics. Barbara's designs, however, consistently went beyond the abilities of current postscript interpreters. Unfortunately, we didn't write the software... so when we phoned the creators they just said, "Oh, gee, sorry. You'll just have to do less complicated things!" The keyboard overlays were difficult for a different reason: we redesigned about as fast as she could redraw them on the Mac! For surviving these trials and tribulations, she wins MicroProse's competitive and coveted "most tolerant artist of the year" award.

Everybody at MicroProse takes Ken Lagace for granted. He's the quiet, silver-haired gent who gave up teaching and performing professional classical music for a career as a computer sounds composer, with scores of brilliant scores to his credit. You'll probably take him for granted too, since the sounds for F-19 Stealth Fighter fit right in!

Finally, the QA (quality assurance) staff at MicroProse approached this product like all others: with the maniacal glee of a mad scientist! Al Roireau, Chris Taormino and Russ Cooney just love to find bugs, then torment the poor, exhausted programmers with multi-page bug reports. In fact, they enjoyed it so much they stayed late nights, then came in on Saturdays and Sundays, for weeks on end, for just that purpose. In fact they're still cackling over the airfield-in-the-ocean bug, or the 1500 kts level flight bug, or... well, you get the idea. Unlike many software companies, at MicroProse QA really *does* have the final say for shipment. Until "Big Al" gives thumbs up, the product stays in testing and the programmers continue slaving over the bugs.

F-19 Stealth Fighter is protected from duplication in software, and through the aircraft identification quiz. Responding to past critiques, we've changed our schemes, making them unobtrusive. You can copy files to and from hard disks normally. However, we have not removed software copy protection.

The reason is simple: the tragic truth is that some people aren't as honest as you, the reader, who's purchased *F-19 Stealth Fighter*. The situation is much worse abroad, where organized piracy of American software is rampant in many nations. A substantial portion of your purchasing dollars go toward R&D on new and better simulations. Your purchase helps support our future work on new and better simulations. In other words, by buying this product, you're investing in quality future products. Copy protection is an "insurance policy" that helps protect and maximize this investment.

Copy Protection

Secrets & Politics

When creating simulations of military equipment that are partly or entirely classified, such as a stealth fighter, MicroProse has a standing policy: use only unclassified sources. Although we talk to real pilots and military personnel, we neither solicit nor use any classified information. Naturally, we must make some educated guesses. However, the amount of information available to the public is quite remarkable if you know where to look and how to interpret seemingly unrelated details. In the past our "guesses" have turned out correct more often than we imagined. One USAF pilot, a brigadier general, confessed to us his surprise at how close our C64 version was to an unspecified plane he'd worked with!

Our selection of regions for game scenarios is not intended to convey a political viewpoint, or promote antipathy toward any nationality or race. Military forces are required to fight whomever their government says is the enemy (even other family members, in a civil war). In this simulation, as in all our products, political circumstances of the day dictate who is hostile to whom. In the late 1980s problems with Libya, Iran, and the USSR loom large in America's war planning.

In summary, military simulations like *F-19 Stealth Fighter* allow us to experience the vicarious thrills of combat flying without having to declare war on anyone, much less hurt anybody. We enjoyed creating *F-19 Stealth Fighter*. We're sure you'll enjoy flying her.

Further Reading

A wide variety of sources were consulted for this simulation. No single source gives specifics on aircraft tactics and weapons, especially as they apply to a hypothetical stealth fighter. Among the many books and magazines used, the following stand out as generally available and interesting reading:

Books

Advanced Technology Warfare, by Friedman, Miller, Richardson, Gunston, Hoobs and Walmer, 1985, Salamander Books, London / Crown Publishers, New York. This book has a variety of interesting details about current and near future equipment and tactics, including various speculative designs for stealth fighters.

Arsenal of Democracy, by Tom Gervasi, various editions in early 1980s, Grove Press Inc., New York City. This volume, updated with II, and later III, is a detailed survey of all American defense systems. Although the author's intent was perhaps to horrify you with the cost, purpose, and occasional ineptitude in the systems described, the volume does have a variety of details and illustrations unavailable elsewhere.

Fighter Combat: Tactics and Maneuvering, by Robert L. Shaw, 1985, Naval Institute Press, Annapolis, Maryland. This is the book on modern fighter tactics. Extremely detailed, technical, and specific, it puts all other books to shame. If you're serious about dogfighting with jets, put aside the glossy picture books and dig into this.

Modern Airborne Missiles, by Bill Gunston, 1983, Salamander Books, London / Arco, New York. This small, moderately priced volume is an excellent unified source of data on airborne missiles, including model histories that would otherwise require considerable digging. Unlike most volumes in the series, it has some very useful and specific data.

Modern Weapons, Ray Bonds editor, 1985, Salamander Books, London / Crescent Books, New York. Of the innumerable Salamander books on modern military equipment (books which often copy sections from one another!), this volume stands out as a useful, concise source for many items.

Modern Air Combat, Bill Gunston & Mike Spick, 1983, Salamander Books, London / Crescent Books, New York. This is the standard glossy "picture book" about modern air warfare. It is an excellent and entertaining introduction to the subject, with lots of useful illustrations. If you're limited to just one book on contemporary air warfare, buy this one.

Stealth Aircraft, Bill Sweetman, 1986, Motorbooks International, Osceola, Wisconsin. This book presents a design history of stealth aircraft technology since World War II, details on stealth construction techniques, and speculations on future stealth aircraft, including both the F-19 stealth fighter and the B-2 stealth bomber. The speculations here were very close to the design the USAF unveiled about the B-2 in 1988.

USAFE, by Michael Skinner, 1983, Presidio Press, Novato, California. This small book is full of photographs of the US Air Force in Europe (USAFE) and lots of pilot lingo. The author spent considerable time with combat pilots in Europe, and it shows. If you want to get into the spirit of military flying, this book encapsulates it very nicely.

Zones of Conflict: an Atlas of Future Wars, by Keegan & Wheatcroft, 1986, Simon and Schuster, New York City. This book provides many useful insights into the world's trouble spots, why they are troubled, and the resources of the various contestants. Unfortunately, the book is a bit too general, with little specific data.

Aviation Week & Space Technology, published weekly by McGraw-Hill, New York City. This magazine is the premier source of information about the entire aerospace industry, including military programs. Anyone interested in large scale aviation operations, or in space programs, should subscribe. A variety of articles and reports first appeared here on stealth aircraft and stealth technology.

Jane's Weapon Systems, published annually by Jane's Publishing Company Ltd, London. This expensive volume provides indispensable specifics on missiles, radars, and electronic equipment of all types and descriptions. In other words, it gives the details about the equipment on the weapons platform, an extremely important issue often overlooked in modern warfare. Like all Jane's, the information is limited to what the manufacturer and various national governments publish. However, due to the desire for overseas arms

Periodical Publications

sales, this data can be fairly extensive.

Jane's All the World's Aircraft, published annually by Jane's Publishing Company Ltd, London. This is the standard volume on world aircraft, complete with performance statistics and model variants. Each aircraft is illustrated with both line drawings and photos. Specifics on electronic systems and armament are sparse (see Jane's Weapons Systems for that).

The Military Balance, published annually by International Institute for Strategic Studies, London. This moderately priced report is a gold mine of specific information about equipment and orders of battle for every nation in the world. No serious student of modern military affairs should be without it.

Soviet Military Power, published annually by the US Department of Defense, in Washington DC. This propaganda document appears each year as part of DoD's publicity broadside for more and better weapons (not that America doesn't occasionally need them, mind you!). Although extremely general, it always reveals at least one new Soviet weapon system each year, as well as a variety of small but interesting facts.

War Annual, by John Laffin, published annually by Brassey's, London. This short volume is a compendium of news reports and public statements about any and all wars happening around the world. No less than 34 different wars (including guerilla wars) are listed in the **War Annual 2** of 1987, with three to six pages of information on each. Although the data is slim, the volumes are an excellent continuing overview of current conflicts.

Maps

The Times Atlas of the World, 7th edition (1985), with maps by John Bartholomew & Sons, Edinburgh. This is, by far, the single best volume of topographical world maps currently available. Although the price is high, it's worth any number of less expensive volumes (we have five others, and none match this one).

Defense Mapping Agency, Washington DC, produces land, sea, and aeronautical maps and charts for the military, and for various civilian agencies such as the National Ocean Service. The military maps available through the DMA vary from year to year with the whims of policy. Our practice is to purchase anything interesting every few years, since they do not maintain a back catalog (i.e., what they have now is usually unavailable a few years hence).

Credits

Game Design

Sid Meier

(based on an original design by Jim Synoski and Arnold Hendrick)

IBM Programming

Andy Hollis, Sid Meier and Jim Synoski
with David McKibbin

Computer Graphics

Max Remington III
with Murray Taylor

World Graphics Database

Bruce Shelley
with Max Remington III

Music & Sound Effects

Ken Lagace

Quality Assurance

Alan Roireau

Playtesting

Alan Roireau, Chris Taormino, Russ Cooney, Chuck Dixon, Steve Meyer,
Bill Stealey, Arnold Hendrick, Bruce Shelley, Sid Meier

Manual

Arnold Hendrick

Maps & Illustrations

Barbara Bents and Murray Taylor

Packaging

Mark Ciola
with John Emory

Copyright Notice

**Copyright ©1988 by
MicroProse Software, Inc.,
all rights reserved.**

This manual and the computer programs and audiovisuals on the accompanying floppy disks, which are described by this manual, are copyrighted and contain proprietary information belonging to MicroProse Software, Inc. No one may give or sell copies of this manual or the accompanying disks or of listings of the programs on the disks to any person or institution, except as provided for by the written agreement with MicroProse Software, Inc. No one may copy, photocopy, reproduce, translate this manual or reduce it to machine readable form, in whole or in part, without the prior written consent of MicroProse Software, Inc. Any person/persons reproducing any portion of this program, in any media, for any reason, shall be guilty of Copyright Violation, and shall be subject to civil liability at the discretion of the copyright holder.

MICROPROSE
Simulation Software
180 Lakefront Drive, Hunt Valley, Maryland, 21030 (301) 771-1151

Limited Warranty

Neither MICROPROSE SOFTWARE, INC., nor any dealer or distributor makes any warranty, express or implied, with respect to this manual, the disk or any related item, their quality, performance, merchantability, or fitness for any purpose. It is the responsibility solely of the purchaser to determine the suitability of the products for any purpose. Some states do not allow limitations on implied warranties or how long an implied warranty lasts, so the above limitation may not apply to you.

As a condition precedent to the warranty coverage provided below and to ensure identification, the original purchaser must complete and mail to MicroProse Software, Inc., 180 Lakefront Drive, Hunt Valley, Maryland 21030, within 30 days after purchase, the Registration/Warranty card enclosed in this product. To the original purchaser only, MicroProse Software, Inc. warrants the media to be free from defects in material for 90 days. If during the first 90 days after purchase a defect in media should occur, the software may be returned to MicroProse Software, Inc., who will replace the media at no charge. If at any time after the initial 90 day period your media becomes defective, the media may be returned to MICROPROSE SOFTWARE for replacement at a \$10 service charge.

In no case will MicroProse Software, Inc. be held liable for direct, indirect or incidental damages resulting from any defect or omission in the manual, or other related items and processes, including, but not limited to, any interruption of service, loss of business, anticipated profit, or other consequential damages. Some states do not allow the exclusion or limitation of incidental or consequential damages, so the above limitation or exclusion may not apply to you.

This warranty gives you specific legal rights, and you may also have other rights which vary from state to state.

IMPORTANT: The above warranty does not apply if the you make any unauthorized attempt to modify or duplicate the product, or if the product has been damaged by accident or abuse.

MICROPROSE
Simulation Software
180 Lakefront Drive, Hunt Valley, Maryland, 21030 (301) 771-1151

Index

Note: This index only references major descriptive sections, and is intended or quick, explanatory references.

- A**
- A-6E "Intruder" bomber: 161
 - A-10A "Thunderbolt II" bomber: 162
 - AA-2 "Atoll" IR guided missile, data: 132, 136
 - AA-6 "Acrid" IR guided missile, data: 132, 137
 - AA-6 "Acrid" radar-guided missile, data: 132, 138
 - AA-7 "Apex" IR guided missile, data: 132,137
 - AA-7 "Apex" radar-guided missile, data: 132,138
 - AA-8 "Aphid" IR guided missile, data: 132,137
 - AA-9 "Amos" radar-guided missile, data: 132, 139
 - AA-10 "Alamo" IR guided missile, data: 132, 137
 - AA-10 "Alamo" radar-guided missile, data: 132, 139
 - AAM: see air-to-air missiles, or specific model name
 - Accelerated time: 33
 - Acrid (AA-6) radar-guided missile, data: 132, 138
 - Acrid IR (AA-6 IR) guided missile, data: 132, 137
 - AEW&C airborne early warning & control planes, Il-76 "Mainstay": 102, 109, 169, 120, 125
 - AGM-65D "Maverick" air-to-ground missile, data: 129-131, 141
 - AGM-84A "Harpoon" air-to-ship missile, data: 129-131, 140
 - AGM-88A "HARM" anti-radar missile, data: 129-131, 141
 - AIM-120A AMRAAM radar-guided missile, data: 129-131, 135
 - AIM-7E "Sparrow" radar-guided missile, data: 132, 138, 115
 - AIM-9H "Sidewinder" IR guided missile, data: 132, 136, 115
 - AIM-9M "Sidewinder" IR guided missile, data: 129-131, 135
 - Air-to-air combat: 57-58, 91-96, 101-103
 - Air-to-air missiles, data: 129-132, 136-141
 - Air-to-air missiles, how to use: 44, 57-58, 89-90, 92
 - Air-to-air missiles, principles of: 89
 - Air-to-air missions, described: 101-103
 - Air-to-ground combat: 78-88, 103-105
 - Air-to-ground missiles, data: 129-132, 140-146
 - Air-to-ground missiles, how to use: 44, 57-58, 78-79, 89-90, 92
 - Airbase layout: 51-52
 - Aircraft carrier deck layout: 51-52
 - Aircraft carrier landings: 54-55, 71-73
 - Aircraft carrier launches: 49
 - Aircraft, data: 158-169
 - Aircraft, identification of: 25, 157-169
 - Airdrop, of special equipment: 60, 103
 - Air Force Cross (AFC): 65, 67, back cover
 - Airman's Medal (AM): 23, 65, back cover
 - Alamo (AA-10) radar-guided missile, data: 132, 139
 - Alamo IR (AA-10 IR) guided missile, data: 132, 137

Amos (AA-9) radar-guided missile, data: 132, 139
AMRAAM (AIM-120A) radar-guided missile, data: 129-131, 135
An-72 "Coaler" air transport: 169, 109, 115, 120, 126
Angle of attack: 70
Apex (AA-7) radar-guided missile, data: 132,138
Apex IR (AA-7 IR) guided missile, data: 132,137
Aphid IR (AA-8 IR) guided missile, data: 132,137
Arming: 29, see also Ordnance
ASM air-to-ship missiles: see air-to-ground missiles, Penguin, or Harpoon
Atoll (AA-2) IR guided missile, data: 132, 136
Austria: see Central Europe
Autopilot and "AUTO" light: 40
AV-8B "Harrier II" fighter: 161

"Boss" hide game: 33
B-1B bomber: 163
Backfire (Tu-26) bomber: 168
Bail out: 43, 64
Bay doors: 44
Bear (Tu-95) recon or cruise missile bomber: 168, 109, 115, 120, 125
Bombing runs: see air-to-ground combat, level bombing, dive bombing, toss bombing.
Bombsight, symbology on HUD: 36-37
Bombsight, use of: 58-59
Brakes: 40
Briefing, missions: 101-105
Briefing, regions: 106-126
Briefing, postflight: 64-66
Briefing, preflight: 25-30

B

Cam (tracking camera) views: 43, 56
Camera, 135mm/IR reconnaissance, use of: 60, 81, 103
Camera, 135mm/IR reconnaissance, data: 146
Camera, tracking: see tracking camera
Cannon, data: 129-131, 135, 136, 140
Cannon, how to fire: 44, 57, 78, 90-91
Carrier: see Aircraft Carrier
CBU-72 FAE laser-guided bomb, data: 129-131, 142
Central Europe, detailed briefing: 122-126
Central Europe, selection of: 26, 11-12, 7
Chaff: 46-47, 62, 83, 88
Chase plane view: 31
Chasing the gauges: 50
Coaler (An-72) air transport: 169, 109, 115, 120, 126
Cockpit, view selection: 31, 40
Cold war: 26, 64, 99
Conflict level: 26, 64, 99-100
Congressional medal of honor (CMOH): 65, 97, back cover
Contents, table of: 3

C

Control stick: 39, 50, see also Technical Supplement
Conventional war: 26, 64, 100
Copyright notice: 182
Crashes: 28, 51, 64
Credits: 181
CRTs, explained: 38-39, see also Technical Supplement
Czechoslovakia: see Central Europe

D Damage: 47-48
Data charts, weaponry/ordnance: 129-134
Debriefing, after the flight: 64-66
Decorations: 65, 23, 67, 97, 127, back cover
Decoys: 47, 62, 83, 86
Defending against attack: 62-63, 83-84, 86-87, 93, 96
Designate a new target: 44
Designer's notes: 174-180
Detail adjust: 33, see also Technical Supplement
Distinguished Flying Cross (DFC): 23, 65, back cover
Dive bombing: 80
Dogfighting: 93-96
Doppler search radar: 61, 75
Duty Roster: 25
Durandal anti-runway retarded bomb, data: 129-131, 143

E E-3C "Sentry" AWACS plane (AEW&C): 163
Eagle (F-15C) fighter: 159-160
Early turn maneuver: 92
Easy landings: 28, 51
ECM (electronic counter-measures): 46, 83
EF-111A "Raven" electronic warfare bomber: 162
Eject: 43, 64
Elite opponents: 28
EMV (electro-magnetic visibility) scale: 45
EMV, use of: 61, 76, 83, 85-86
Enemy attacks, defense against: 62-63, 83-84, 86-87, 93, 96
Europe: see Central Europe
Extra Fuel: 42, 146

F F-4E "Phantom II" fighter: 158, 114-115
F-5E "Tiger II" fighter: 158-159, 114-115
F-14D "Tomcat" fighter: 159, 114-115
F-15C "Eagle" fighter: 159-160
F-16C "Falcon" fighter: 160
F-19 "Frisbee" stealth fighter, infrared signature: 85
F-19 "Frisbee" stealth fighter, radar signature: 74-75
F-19 "Frisbee" stealth fighter, technical data: 4
F/A-18A "Hornet" fighter: 160
FAE fuel-air explosive (CBU-72) laser-guided bomb, data: 129-131, 142
Falcon (F-16C) fighter: 160
Fencer (Su-24) bomber: 166

FIM-43A "Redeye" IR-guided SAM, data: 133-134, 153
FIM-92A "Stinger" IR-guided SAM, data: 133-134, 154
Fire-and-forget: 77-78, 89-90, 93
Fireye (Mk 122) free-fall bomb, data: 129-131, 145
Fishbed (MiG-21) fighter: 164, 108-109
Flanker (Su-27) fighter: 167, 120, 125
Flaps: 49
Flare: 47, 62, 86
Flight performance options: 28, 51
Flogger (MiG-23) fighter: 164, 108-109, 125
Flogger (MiG-27) bomber: 165, 108-109
Flying techniques: 50
Forger (Yak-38) fighter-bomber: 167, 120, 121
Foxbat (MiG-25) interceptor: 165, 108-109, 120
Foxhound (MiG-31) interceptor: 166, 120, 125
Free-fall bombs, use of: 59-60, 79-80
Fuel: 42, 146
Fulcrum (MiG-29) fighter: 165-166, 108-109, 120, 125

G

Gadfly (SA-11) radar-guided SAM, data: 133-134, 150
Gainful (SA-6) radar-guided SAM, data: 133-134, 149-150
Gammon (SA-5) radar-guided SAM, data: 133-134, 148
Ganef (SA-4) radar-guided SAM, data: 133-134, 149
Gaskin (SA-9B) IR-guided SAM, data: 133-134, 154
GBU-12 paveway laser-guided bomb, data: 129-131, 142
Gear and "GEAR" light: 40, 48
Gecko (SA-8) radar-guided SAM, data: 133-134, 150
Germany: see Central Europe
Gladiator (SA-12) radar-guided SAM, data: 133-134, 149
Glossary: 171-173
Gopher (SA-13) IR-guided SAM, data: 133-134, 154
Grail (SA-7B) IR-guided SAM, data: 133-134, 153
Green opponents: 27
Grumble (SA-10) radar-guided SAM, data: 133-134, 148-149
Guided missiles: see air-to-air or air-to-ground missiles
Guideline (SA-2) radar-guided SAM, data: 133-134, 148
Gun: see cannon
Gunsight, use of: 57, 78, 90-91

H

HARM (AGM-88A) anti-radar missile, data: 129-131, 141
Harpoon (AGM-84A) air-to-ship missile, data: 129-131, 140
Harrier II (AV-8B) fighter: 161
HAWK (MIM-23B) radar-guided SAM, data: 133-134, 150-151
Hitting the target: 57, 42
Hornet (F/A-18A) fighter: 160
HUD, advice on use of: 50
HUD AIR-AIR mode: 36-37, 34-35
HUD AIR-GROUND mode: 37-38, 34-35
HUD display, explained: 34-36

HUD modes: 34
HUD NAV mode: 34-36

- I** Identification quiz, aircraft: 25
 - IL-76 "Mainstay" AEW&C plane: 169, 102, 109, 120, 125
 - ILS (instrument landing system): 52-54, 42, 18-19
 - Immelmann turn: 94
 - INS (inertial navigation system): 41
 - Installing simulation for your computer: see also Technical Supplement
 - Intelligence briefing: 29
 - Intruder (A-6E) bomber: 161
 - Inverse tactical ("Invrs Tacti") view: 32
 - IR (infrared), generations: 85
 - IR (infrared) guided surface-to-air missiles (SAMs): 62-63, 84-85, 133-134, 147-152
 - IR (infrared) jammer and "IRJ" light: 45-46, 62, 86, 93
 - Iran: see Persian Gulf
 - Iraq: see Persian Gulf
 - ISC B-1 minelets, retarded bomb dispenser: 129-131, 144
-

- L** Landing, on an aircraft carrier: 54-55, 71-73
 - Landing, gear and "GEAR" light: 40, 48
 - Landing, importance of: 64
 - Landing, military: 71-73
 - Landing, options: 28
 - Landing, secret airstrips: 103
 - Landing, straight-in: 54-55
 - Launching, from an aircraft carrier: 49
 - Laser-guided bombs: 58, 79, 142-143
 - Level bombing: 59, 79
 - Level flight: 50, 69-70
 - Level of conflict: 26, 64, 99-100
 - Libya, detailed briefing: 106-109
 - Libya, selection of: 26, 11-12, 7
 - Lift: 69-70
 - Limited war: 26, 64, 100
 - Limited warranty: 183
 - Loading into your computer: see also Technical Supplement
-

- M** M61A1 20mm cannon, data: 129-131, 135, 136, 140
- M61A1 20mm cannon, how to fire: 44, 57, 78, 90-91
- Mainstay (IL-76) AEW&C plane: 169, 102, 109, 120, 125
- Maneuvering: see outmaneuvering missiles or air-to-air combat
- Map coordinates (ONC): 100
- Maverick (AGM-65D) air-to-ground missile, data: 129-131, 141
- Medals: 65, 23, 67, 97, 127, back cover
- MiG-21 "Fishbed" fighter: 164, 108-109
- MiG-23 "Flogger" fighter: 164, 108-109, 125
- MiG-25 "Foxbat" interceptor: 165, 108-109, 120
- MiG-27 "Flogger" bomber: 165, 108-109
- MiG-29 "Fulcrum" fighter: 165-166, 108-109, 120, 125

MiG-31 "Foxhound" interceptor: 166, 120, 125
Military Landing: 71-73
Minelets (ISC B-1), retarded bomb dispenser: 129-131, 144
Missile view: 32
Missile warnings: 45-46, 84
Mission, description of: 29, 101-105
Mission, selection of: 27, 65
Mission, summary of while in flight: 42
Mission, tactics: 101-105
Mk 20 "Rockeye" retarded bomb, data: 129-131, 143
Mk 20 "Rockeye II" laser-guided bomb, data: 129-131, 142-143
Mk 35 incendiary cluster, retarded bomb, data: 129-131, 144
Mk 82-0 "Slick" free-fall bomb, data: 129-131, 145
Mk 82-1 "Snakeye" retarded bomb, data: 129-131, 144
Mk 122 "Fireye" free-fall bomb, data: 129-131, 145
Murmansk: see North Cape

No crashes: 28, 51, 64
Normal time: 33
North Cape, detailed briefing: 116-121
North Cape, selection of: 26, 11-12, 7
Norway: see North Cape

N

Officer's Club: 66
ONC map coordinates: 100
Opponent selection: 27
Ordnance, effectiveness ratings: 131
Ordnance data: 129-131, 135, 140-146
Ordnance selection, at start of mission: 29, 101
Ordnance selection, while in flight: 43-44
Outmaneuvering missiles: 87, 83-84, 86

O

Parachute: see Eject
Paradrop: see Airdrop
Pause: 33, see also Technical Supplement
PAVE TACK: 58, 79, 142-143
Paveway (GBU-12) laser-guided bomb: 129-131, 142
Penguin-3 air-to-ship missile, data: 129-131, 140
Persian Gulf, detailed briefing: 110-115
Persian Gulf, selection of: 26, 11-12, 7
Phantom II (F-4E) fighter: 158, 114-115
Photo recon: see camera, 135mm/IR
Pilot Roster: 25
Poland: see Central Europe
Promotions: 65-66
Pulse search radar: 61, 75
Purple Heart (PH): 65, 127, back cover

P

Quickstart: 7
Quit simulation: 33, see also Technical Supplement

Q

R "R" warning light: 45-46, 84
Radar-guided surface-to-air missiles (SAMs): 62-63, 81-82, 133-134, 147-152
Ranks: 66
Rapier radar-guided SAM, data: 133-134, 151
Raven (EF-111A) electronic warfare bomber: 162
Realistic landings: 28, 51
Reconnaissance photos: see camera, 135mm/IR
Redeye (FIM-43A) IR-guided SAM, data: 133-134, 153
Region of the world selection: 26
Regular opponents: 27
Resupply: 33, see also Technical Supplement
Retirement: 66
Rockeye (Mk 20) retarded bomb, data, 129-131, 143
Rockeye II (Mk 20) laser-guided bomb, data: 129-131, 142-143
Roster: 25
Rules of engagement (ROE): 99-100
Russia: see North Cape, Central Europe, and appropriate equipment entries

S SA-2 "Guideline" radar-guided SAM, data: 133-134, 148
SA-4 "Ganef" radar-guided SAM, data: 133-134, 149
SA-5 "Gammon" radar-guided SAM, data: 133-134, 148
SA-6 "Gainful" radar-guided SAM, data: 133-134, 149-150
SA-7B "Grail" IR-guided SAM, data: 133-134, 153
SA-8 "Gecko" radar-guided SAM, data: 133-134, 150
SA-9B Gaskin IR-guided SAM, data: 133-134, 154
SA-10 "Grumble" radar-guided SAM, data: 133-134, 148-149
SA-11 "Gadfly" radar-guided SAM, data: 133-134, 150
SA-12 "Gladiator" radar-guided SAM, data: 133-134, 149
SA-13 Gopher IR-guided SAM, data: 133-134, 154
SA-14 IR-guided SAM, data: 133-134, 153-154
SA-16 IR-guided SAM, data: 133-134, 153-154
SA-N-4 radar-guided naval SAM, data: 133-134, 151, 120, 126
SA-N-5 IR-guided naval SAM, data: 133-134, 155, 108-109, 120, 126
SA-N-6 radar-guided naval SAM, data: 133-134, 152, 120
SA-N-7 radar-guided naval SAM, data: 133-134, 152, 120, 126
SAM: see surface-to-air missiles
Satellite/radar map on CRT: 38, see also Technical Supplement
Saudi Arabia: see Persian Gulf
Save simulation: 33, 66, see also Technical Supplement, see also Installation in
Technical Supplement
Scissors turn: 94
Seacat visually-guided SAM, data: 133-134, 155
Search (radar) warning: 45, 84
Sentry (E-3C) AWACS plane (AEW&C): 163
Ships, tactics against: 104, 131
Shoulder-launched surface-to-air missiles (SAM): 84-85, 133-134, 153-154
Side view: 31
Sidewinder (AIM-9H), data: 132, 136, 115
Sidewinder (AIM-9M), data: 129-131, 135

Silver Star: 65, 67, back cover
Slick (Mk 82-0) free-fall bomb, data: 129-131, 145
Slot view: 31
Snakeye (Mk 82-1) retarded bomb, data: 129-131, 144
Sparrow (AIM-7E) radar-guided missile, data: 115, 132, 138
Special equipment: 60, 103, 146
Split-S turn: 95
Stalls: 71
Stealth design and technology: 74-75
Stealth flying: 61, 76-77
Stinger (FIM-92A) IR-guided SAM, data: 133-134, 154
Straight-in landing: 54-55
Strike missions described: 103-105
Su-24 "Fencer" bomber: 166
Su-27 "Flanker" fighter: 167, 120, 125
Submarine pens: 104, 119, 131
Surface-to-air missiles, data: 133-134, 147-156
Surface-to-air missiles, principles: 81-82, 84-85
Surface-to-air missiles, tactics against: 62-63, 83-87, 104, 131
Sweden: see North Cape
Systems damage: 47-48

Tactical ("Tacti") view: 31
Tactical display on CRT: 38-39, see also Technical Supplement
Takeoff: 49-50
Target, box on HUD: 36-37
Target, designation of new: 44
Target, locating and selecting: 56, 44
Target, hit and miss: 42, 57
Threading the needle: 76-77
Throttle: 39-40
Thunderbolt II (A-10A) bomber: 162
Tigercat visually-guided SAM, data: 133-134, 155
Tiger II (F-5E) fighter: 158-159, 114-115
Tomcat (F-14D) fighter: 159, 114-115
Toss bombing: 58
TRAK warning light: 45, 84
Tracking box/oval on HUD: 43-44
Tracking camera: 43, 56
Training mission selection: 27, 65
Training option in-flight: see also Technical Supplement
Tu-26 "Backfire" bomber: 168
Tu-95 "Bear" recon or cruise missile bomber: 168, 109, 115, 120, 125
Turning: 50-51, 70
Turning inside, dogfighting maneuver: 93-94
Turning inside, missile defense maneuver: 86, 87
Tutorial, complete: 11-122
Tutorial, quickstart: 7-9

T

V Veteran opponents: 28
View, from the cockpit: 40-41
View, from tracking camera: 43
View, of cockpit and HUD: 31, 40
View, out-of-plane: 31-32
Volume adjust: 33, see also Technical Supplement

W War, cold, limited or conventional: 26, 64, 99-100
Warranty: see Limited warranty
Waypoints: 41
Weaponry: see Ordnance
Weapons bay doors: 44
Wide-angle view: 32

Y Yak-38 "Forger" fighter-bomber: 167, 120, 121
Yo-yo turn: 95

Unit 1, Hampton Road Industrial Estate, Tetbury, Glos. GL8 8LD. Tel: 0666 504326

F-19 STEALTH FIGHTER

Technical Supplement
Atari ST & Commodore Amiga

Seventh Draft: 6.6.90



The logo features the characters 'F-19' in a bold, three-dimensional, blocky font. Each character is composed of multiple parallel lines, creating a sense of depth and shadow. The 'F' and '9' are particularly prominent, with the '9' having a large, rounded bottom loop. The hyphen is smaller and positioned between the 'F' and '9'. Below this stylized text, the words 'STEALTH FIGHTER' are written in a clean, black, sans-serif, all-caps font.

STEALTH FIGHTER

F - 19 STEALTH FIGHTER. GETTING STARTED.

Required Equipment

Please note that this simulation requires a minimum of 512 K of RAM. A colour monitor or television is required for the ST version.

This simulation can be run entirely from the keyboard, with mouse and keyboard, or with joystick and keyboard. A joystick greatly improves the "feel" and realism, and is therefore strongly recommended.

Installation

The F-19 Stealth Fighter manual asks you to install the simulation onto back-up Floppy Disks. This is only necessary for IBM PC compatible versions. You do not need to install Atari ST or Commodore Amiga versions.

Your pilot records will be automatically saved to disk A, provided that it is write-enabled prior to loading.

Atari ST

Turn off your computer and remove all unnecessary peripherals. Insert Disk A into the internal drive and switch on the computer. The program will auto-load. Please follow any on-screen prompts. (If you have an additional external drive, disk B may be inserted into this drive, and will be automatically accessed by the computer when necessary).

Commodore Amiga

Turn off your computer and remove all unnecessary peripherals. Insert Disk A into the internal drive and switch on the computer. The program will auto-load. Please follow any on-screen prompts.

WHAT IF MY GAME FAILS TO LOAD ?

In the vast majority of cases a loading problem is not because of faulty software, but either an incorrect loading procedure or a hardware fault.

Please ensure that the loading instructions have been correctly executed. The commonest hardware failures are due to a misalignment of the heads in the disk drive. Such faults may be detected by loading the game on another computer. (Either use a friend's machine or ask the software store from which the game was purchased to test it).

Alternatively, a virus may have transferred into your hardware from another piece of software. Pirated copies of games are an incredibly common source of viruses. It always pays to own original software.

In the unlikely event of a software fault, please return the complete package, with receipt to the place of purchase. MicroProse regret that goods cannot be replaced unless bought from the company directly.

If you have any difficulty whilst loading F-19, or need help whilst running the simulation, MicroProse will be happy to help you on the Helpline. Please ring (0666) 504399.

FACT OR FICTION ? : THE DEVELOPMENT OF "F-19 STEALTH FIGHTER"

NEWSFLASH

*From the Department of
Defense, Office of the
Assistant Secretary (Public
Affairs)*

November 10, 1988 (Washington D.C.): Today the U.S. Air Force announced the existence of an operational stealth fighter aircraft. This single seat, dual-engine jet was constructed by the Lockheed Corporation. built with bipartisan congressional support, it has been operational since 1983 with the 4450th Tactical Group, based on the Tonopah Airfield at Nellis Air Force Base, Nevada.

Technical specifications, possible missions, and operations have not been disclosed. However, design features and the use of A-7 trainers suggest that the plane is intended for clandestine reconnaissance, ground attack, and air-to-air ambushes. In short, the US Air Force's actual stealth fighter is amazingly similar to MicroProse's "F-19 Stealth Fighter" simulation, published for IBM PC compatible machines twelve months prior to the actual plane's disclosure. It is known that the Air Force uses the designation "F-117A" instead of "F-19".

Stealth Fighter

- 1978:** Lockheed receives the program "go ahead" from the U.S Department of Defense.
- 1981:** Lockheed test-flies the new Stealth Fighter.
- 1983:** The U.S. Air Force accepts delivery of the first fighters and the 4450th TG becomes an operational unit.
- 1986:** A fatal Stealth Fighter crash in Bakersfield, California is hushed up by the Air Force before the news media discovers what happened.
- 1987:** MicroProse first publishes a Stealth Fighter computer simulation for IBM PC compatible machines.
- 1988:** The U.S. Air Force admits that Stealth Fighters

have been operational for the last five years.

- 1989:** MicroProse begin work in the UK on "F-19 Stealth Fighter" for Atari ST and Commodore Amiga machines. The decision is taken to retain the original characteristics of MicroProse's "F19 Stealth Fighter", as a testament to the accuracy of MicroProse's research, and to enhance the simulation by including an option to see the actual F-117A plane in external 3-D views.
- 1990:** Atari ST and Commodore Amiga versions are released.

Diagrams of F-19 and F-117A

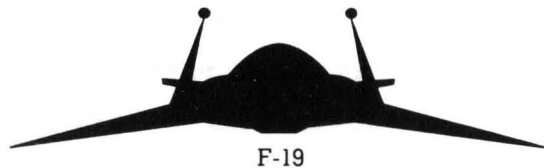

ADDITIONAL FEATURES for ATARI ST and COMMODORE AMIGA VERSIONS

Pre-Flight Options

Method of Control

Once the game has loaded, you will be asked to select your method of control, by pressing one of the numeric keys on the keyboard, as follows;

- 1. Mouse**
- 2. Joystick**
- 3. Keyboard**

The Pilot Roster

The original pilot roster will be automatically updated after each mission, provided that you have write-enabled your disk A. You do not have to 'install' the simulation onto back-up Floppy Disks.

Intelligence Briefing

Move the Controller up and down the list of options to highlight one, and press the Selector to toggle that option on and off.

To receive specific data on an item displayed on the map, move the Controller over that item on the map.

External Aircraft Views

As explained on the previous page, MicroProse's Software Engineers have added the option to view your plane in Slot View, Chase Plane, Side View, Tacti View or Inverse Tacti View, as either the F-19 or F-117A.

Your choice of plane is made immediately after the Mission Briefing, and before choosing the armaments for your mission.

In-Flight

The star system has been accurately mapped and is visible during night missions. It appears on screen as it would according to your actual position and heading. It is therefore possible to navigate by the stars !

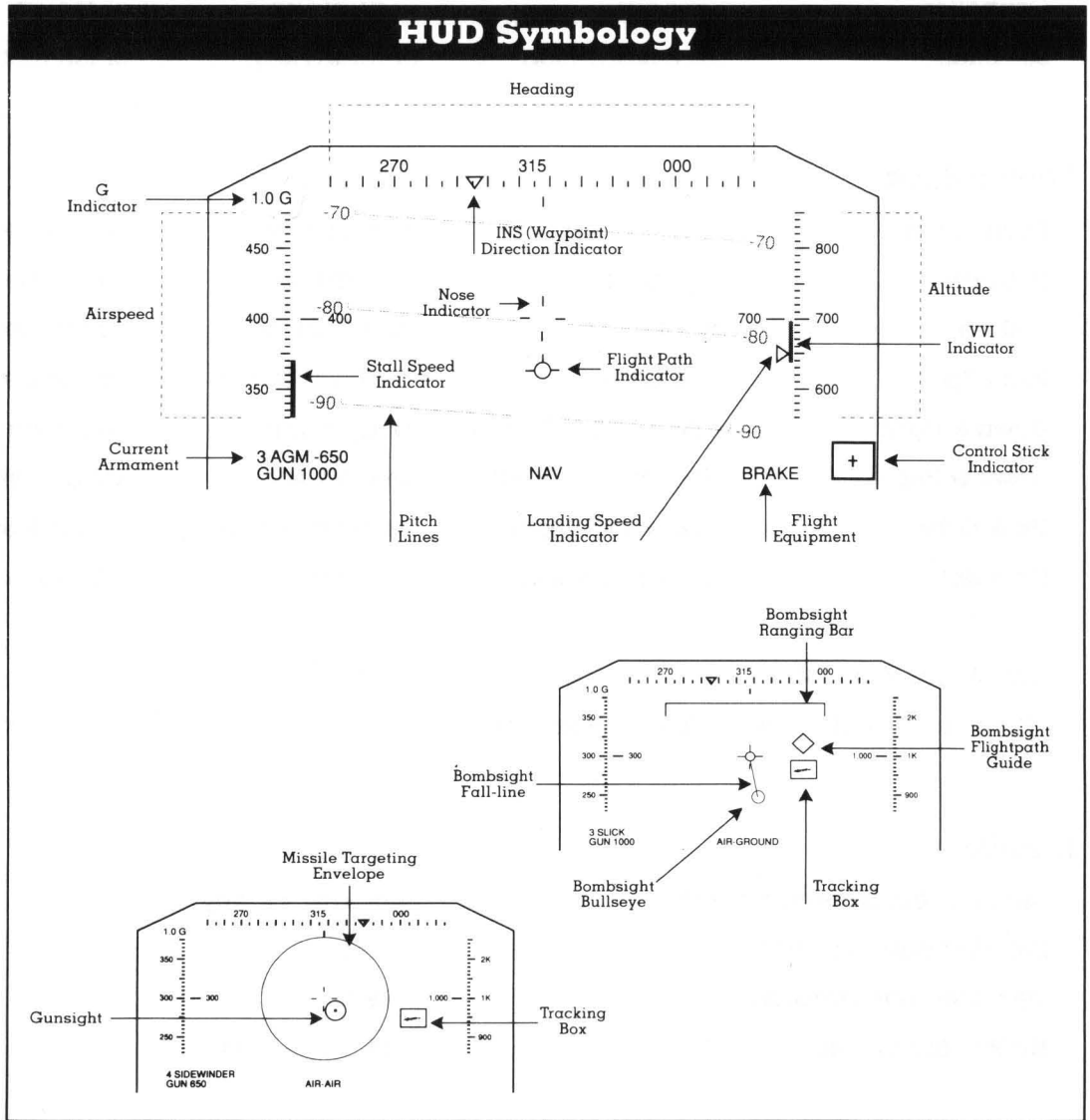

CONTROLS

Preflight & PostFlight Options

Controller	joystick,	or arrow keys,	or mouse
Selection	joystick button,	or return key,	or left mouse button

Control Stick

Pitch Down	stick forward,	or up-arrow,	or mouse forward
Roll right	stick right,	or right-arrow,	or mouse right
Roll left	stick left,	or left-arrow,	or mouse left
Pitch Up	stick back,	or down-arrow,	or mouse back
Down & right	stick forward & right,	or up & right,	or forward & right
Down & left	stick forward & left,	or up & left,	or forward & left
Up & right	stick back & right,	or down & right,	or back & right
Up & left	stick back & left,	or down & left,	or back & left

Adjust stick sensitivity
(tiny, small and medium stick movement)

'Ins' key

Throttle

Max Pwr (maximum power)	Shift and '+' key
Incr (increase throttle)	'=' key
Decr (decrease throttle)	'-' key
No Pwr (no power)	Shift and '_' key

Other Flight Controls

Gear (landing gear toggle)	'6' key (on main keyboard)
Flaps (extend/retract toggle)	'9' key (on main keyboard)
Brakes (on/off toggle)	'0' key (on main keyboard)
Autopilot (on/off toggle)	'7' key (on main keyboard)
Accel (accelerated) time	Shift and 'Z' key
Norm (normal) time	Shift and 'X' key

Out-of-Plane Viewing

Slot View	Shift and 'F1' key
Chase Plane	Shift and 'F2' key
Side View	Shift and 'F3' key
Missile View	Shift and 'F4' key
Tacti view (you & enemy)	Shift and 'F6' key
InvrS tacti (enemy & you)	Shift and 'F7' key

Out-of-Cockpit Viewing

View ahead	Shift and '?/' key
View rear	Shift and '>.' key
View left	Shift and '<,' key
View right	Shift and 'M' key

Other View Keys

Zoom (view or map)	'z' key
Unzoom (view or map)	'x' key
View Angle (narrow or wide)	'c' key

Cockpit Controls

Cockpit View	'F1' key
HUD Modes	'F2' key
CRT Maps (toggles left-side CRT)	'F3' key
Data (on right-side CRT)	'F4' key
Ordnance (on right-side CRT)	'F5' key
System Damage (on right-side CRT)	'F6' key
ILS (on/off the HUD)	'F9' key
Mission (on right-side CRT)	'F10' key
Eject (bail out)	Shift and 'F10' key

INS (Inertial Navigation System)

Select Waypoint (on right-side CRT)	'F7' key
Change Waypoint (on both CRTs)	'F8' key
Reset Waypoint (all)	Shift and 'F8' key
Select/Change Previous Waypoint	Minus (-) key on numeric keypad
Select/Change Next Waypoint	Plus (+) key on numeric keypad
Move Waypoint Up (changing pt)	Up-arrow (numeric keypad '8') key
Move Waypoint Down (changing pt)	Down-arrow (numeric keypad '2') key
Move Waypoint Left (changing pt)	Left-arrow (numeric keypad '4') key
Move Waypoint Right (changing pt)	Right-arrow (numeric keypad '6') key

Tracking Camera (appears on right-side cockpit CRT)

Cam Ahead	`/' key
Cam Rear	`' key
Cam Left	`m' key
Cam Right	`' key
Select Target (in current view arc)	`b' key
Designate New Target (ahead only)	`n' key

Armaments

Ordnance (on right-side CRT)	`F5' key	
Select Ordnance	space bar	
Bay Doors (toggles open/closed)	`8' key (on main keyboard)	
Fire Ordnance	or return key,	or right mouse button
Fire Cannon	joystick button, or backspace key,	or left mouse button

Defences

Flare (drop one cartridge)	`1' key (on main keyboard)
Chaff (drop one cartridge)	`2' key (on main keyboard)
IR Jammer (toggles on/off)	`3' key (on main keyboard)
ECM (radar jammer on/off)	`4' key (on main keyboard)
Decoy (drop one)	`5' key (on main keyboard)

Simulation Controls

Pause (press any key to un-pause)	Alt and 'p' key
"Boss" (hides simulation)	Alt and 'b' key
Quit	Alt and 'q' key
Resupply (training only)	Alt and 'r' key
Change missions to training	Alt and 't' key

Keyboard Control Stick Adjust **'Ins' key**

keybd sensitivity 3 = keypress causes large stick movement

keybd sensitivity 2 = keypress causes moderate stick movement (default)

keybd sensitivity 1 = keypress causes small stick movement

Volume Adjust (4 sound levels) **Alt and 'v' key**

sound level 3 = all sounds

sound level 2 = all sounds except engine background noise (default)

sound level 1 = firing and explosions only (no warning sounds)

sound level 0 = no sound

Detail Adjust (2 levels) **Alt and 'd' key**

detail level 1 = maximum detail on Tactical and Track Cam displays

detail level 0 = normal detail on Tactical and Track Cam displays

Slew Controls (4 directions)

slew north (training only)	Alt and 'y' key
slew west (training only)	Alt and 'j' key
slew south (training only)	Alt and 'k' key
slew east (training only)	Alt and 'l' key

Notes on Simulation Controls

Change Mission to Training (Alt and 't' key) Tapping this key converts your current mission into a training mission. This means that henceforth enemy weapons do no damage. Tapping Alt 't' again exits training.

Once a mission is converted to training you cannot score any points for it, even if you toggle training off again. However, the slew controls and resupply key only function when training is active.

Keyboard Control Stick Adjust ('ins' key) This regulates the amount of control stick movement a keypress causes. We recommend you use this key frequently when flying, and always set the sensitivity to "1" on your final approach to landing.

Detail Adjust (Alt and 'd' key) The detail displayed on the Tactical and Track Cam displays may be altered from normal (detail level = 0) to maximum (detail level = 1). The tactical display shows all the 16 km grid lines at maximum detail, and the Track Cam update will appear to be smoother.

Slew (Alt and 'i','j','k','l' keys) These keys function only in training. Tapping the key "teleports" your aircraft in that direction. The distance you're "teleported" varies with the current Zoom/Unzoom scale of the satellite/radar map. Slew is an excellent way to check out the region whilst training.

Display Colours

HUD Targeting Colours

Black Rectangle
Brown Rectangle
White Rectangle
White hexagon
Red hexagon

Ineffective Weapon (day)
Ineffective Weapon (night)
Effective Weapon
Effective Weapon, locked on target
Highly effective weapon, locked on target

EMV Scale Colours

Red line
Orange line
Yellow line
Light blue line
White line

Enemy Ground radar, has not detected you
Enemy Ground radar, has poor detection
Enemy Ground radar, which detected you
Enemy Aircraft radar, has not detected you
Enemy Aircraft radar, which detected you

Damage Tattletales

Blue
Red

System functioning
System failure (damaged or destroyed)

Autopilot Light

White
Black

Autopilot On
Autopilot Off

Landing Gear Light

Black

Flashing White

White

Landing Gear Up

Landing Gear Down at too high a speed

Landing Gear Down

Other Warning Lights

Bright Colour

Black

On

Off

Satellite/Radar Map

Flashing White Dot

Flashing Yellow-Red

Blinking Red

Red Dot

Black Dot

Yellow Dot

Dotted Line

Solid Line

White Dot

Your Aircraft

Mission objective on ground

Mission objective in air

Other Aircraft

Ground Radar

Enemy Radar

Pulse Radar

Doppler Radar

Takeoff and landing locations

Tactical Display

Grey squares	16km grid
Yellow Radar Dish	Ground Radar
Blue Boat	Warship Radar
Grey Rectangle	Airfield
Red Crossed Circle	Other Ground Targets
Grey airplane	Your F-19
Grey outline	Decoy
White Dots	Chaff
Red & Yellow burst	Flare
Blue Plane	Plane at higher altitude
Light Red Plane	Plane at similar altitude
Yellow Plane	Plane at lower altitude
Yellow Line	Radar-guided missile
Red Line	IR-guided missile
Yellow Line	Visually guided missile
White Line	Missile fired from F-19
White-boxed object	Current target (in your tracking system)
Colour-boxed object	Source of enemy radar signal

INS Waypoints Fuel Bar

Black region	Fuel consumed
White Region	Fuel for flight to current waypoint
Blue Regions	Fuel for flight to other waypoints
Yellow Region	Reserve Fuel

Tips to Pilots

When flying a mission don't expect the enemy to act randomly or stupidly. They have a surprising amount of intelligence. Fighters and AWACS planes patrol to cover radar weak spots, or protect especially important areas.

If you're spotted, interceptors are scrambled and vectored to your last known location. If they lose sight of your F-19, they investigate your last known position, but will eventually give up and go home. In addition, enemy aircraft and radar operators become more aggressive, sometimes even frantic, after they have repeated sightings, or have suffered a few losses.

The best way to get all the trouble you can handle is to engage "regular" or better enemies, and to loiter about the scene of a battle. Conversely, the best way to avoid trouble is to disappear from sight as quickly as possible. In general, trying to take on the entire enemy defence system with one F-19 is very unwise!

CREDITS

**F-19 Stealth Fighter is brought to the Atari ST and
Commodore Amiga thanks to:**

Paul Hibbard - Publisher

Peter Moreland - Development Manager

The MicroProse UK Software Engineers

Adrian Scotney

"Tim"

Malcolm Hellon

and

Mark Scott - Graphic Artist

James Hawkins - 3-D Editing

Martin Moth - 3-D Editing

**Many thanks to our colleagues in MicroProse USA for
producing the brilliant original. Full credits for their work can
be found in the manual.**

Quality Control

Martin Moth

Steve Perry

Additional Documentation - Rob Davies

Packaging - Julie Burness & Karen Wilson

Manual Typesetting - Artistix (U.K.) (0705) 252125

AMIGA 500/2000

Keyboard Overlay

F-19

STEALTH FIGHTER

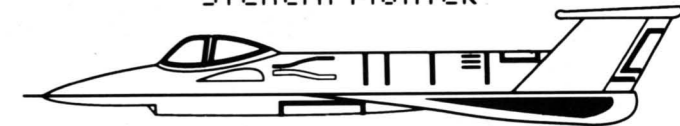

MICRO PROSE™

SIMULATION • SOFTWARE

Copyright © 1990 by Microprose Software, Inc.

Alt	D	Alt	P
DETAIL ADJUST		PAUSE	
Alt	R		
RESUPPLY (TRAINING ONLY)			

SLOT VIEW Shift F1	CHASE PLANE Shift F2	SIDE VIEW Shift F3	MISSILE VIEW Shift F4	TACTI VIEW Shift F5	INVR TACTI Shift F6	RESET WAY PT Shift F8	EJECT Shift F10		
COCKPIT F1	HUD MODES F2	CRT MAPS F3	DATA F4	ORDNANCE F5	SYSTEM DAMAGE F6	SELECT WAY PT F7	CHANGE WAY PT F8	ILS F9	MISSION F10

FLARE 1	CHAFF 2	IR JAMMER 3	ECM 4	DECOY 5	GEAR 6	AUTOPILOT 7	BAY DOORS 8	FLAPS 9	BRAKES 0	NO PWR Shift- DEC -	MAX PWR Shift+ INCR =
-------------------	-------------------	-----------------------	-----------------	-------------------	------------------	-----------------------	-----------------------	-------------------	--------------------	-------------------------------	---------------------------------

..... Joystick or
FIRE CANNON Mouse Button L
 ←

Return
 ↑
FIRE ORDNANCE
 or Mouse Button R

Change Waypoints

LAST POINT
-

NEXT POINT
+

Space Bar **SELECT ORDNANCE** Space Bar

ZOOM □ Shift Z	UNZOOM = Shift X	VIEW ANGLE C 	SELECT TARGET B 	DESIGNATE NEW TARGET N 	CAM LEFT M Shift M	CAM RIGHT < Shift <	CAM REAR > Shift >	CAM AHEAD ?/ Shift ?	Tracking Camera
ACCEL TIME ~~~~~ Shift Z	NORM TIME ▶ Shift X				VIEW LEFT >▲ Shift M	VIEW RIGHT <▲ Shift <	VIEW REAR ▲ Shift >	VIEW AHEAD ▼ Shift ?	

INSERT
 ↑ ↓
 CONTROL SENSITIVITY

ST Keyboard Overlay

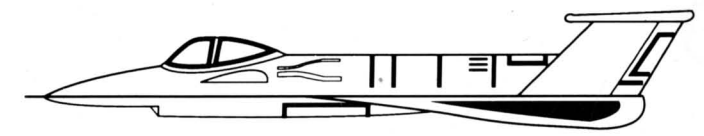

SLOT VIEW Shift F1	CHASE PLANE Shift F2	SIDE VIEW Shift F3	MISSILE VIEW Shift F4	TACTI VIEW Shift F5	INVR5 TACTI Shift F6	RESET WAY PT Shift F8	EJECT Shift F10		
COCKPIT F1	HUD MODE5 F2	CRT MAP5 F3	DATA F4	ORDNANCE F5	SYSTEM DAMAGE F6	SELECT WAY PT F7	CHANGE WAY PT F8	IL5 F9	MISSION F10

Alt D	Alt P
DETAIL ADJUST	PAUSE
Alt Q	Alt R
ABORT PRESENT GAME	RESUPPLY (TRAINING ONLY)

FLARE 1	CHAFF 2	IR JAMMER 3	ECM 4	DECOY 5	GEAR 6	AUTO PILOT 7	BAY DOORS 8	FLAPS 9	BRAKES 0	NO PWR Shift -	MAX PWR Shift +	Throttle	FIRE CANNON Joystick or Mouse Button L
										↓	↑	←	
										DECR	INCR		

ZOOM Z	UNZOOM X	VIEW ANGLE C	SELECT TARGET B	DESIGNATE NEW TARGET N	CAM LEFT M	CAM RIGHT <	CAM REAR >	CAM AHEAD ?/
Shift Z ACCEL TIME	Shift X NORM TIME				Shift M VIEW LEFT	Shift < VIEW RIGHT	Shift > VIEW REAR	Shift ? VIEW AHEAD

Space Bar ← SELECT ORDNANCE → Space Bar

Return

INSERT
↑ ↓ ↔ CONTROL SENSITIVITY

change waypoints
LAST POINT
-
NEXT POINT
+

FIRE ORDNANCE
or Mouse Button R
Tracking Camera



Copyright © 1990 by Microprose Software, Inc.



Central Europe ONC

DMA Edition 11, Series 2105
Sheet 50N15E

Map Key



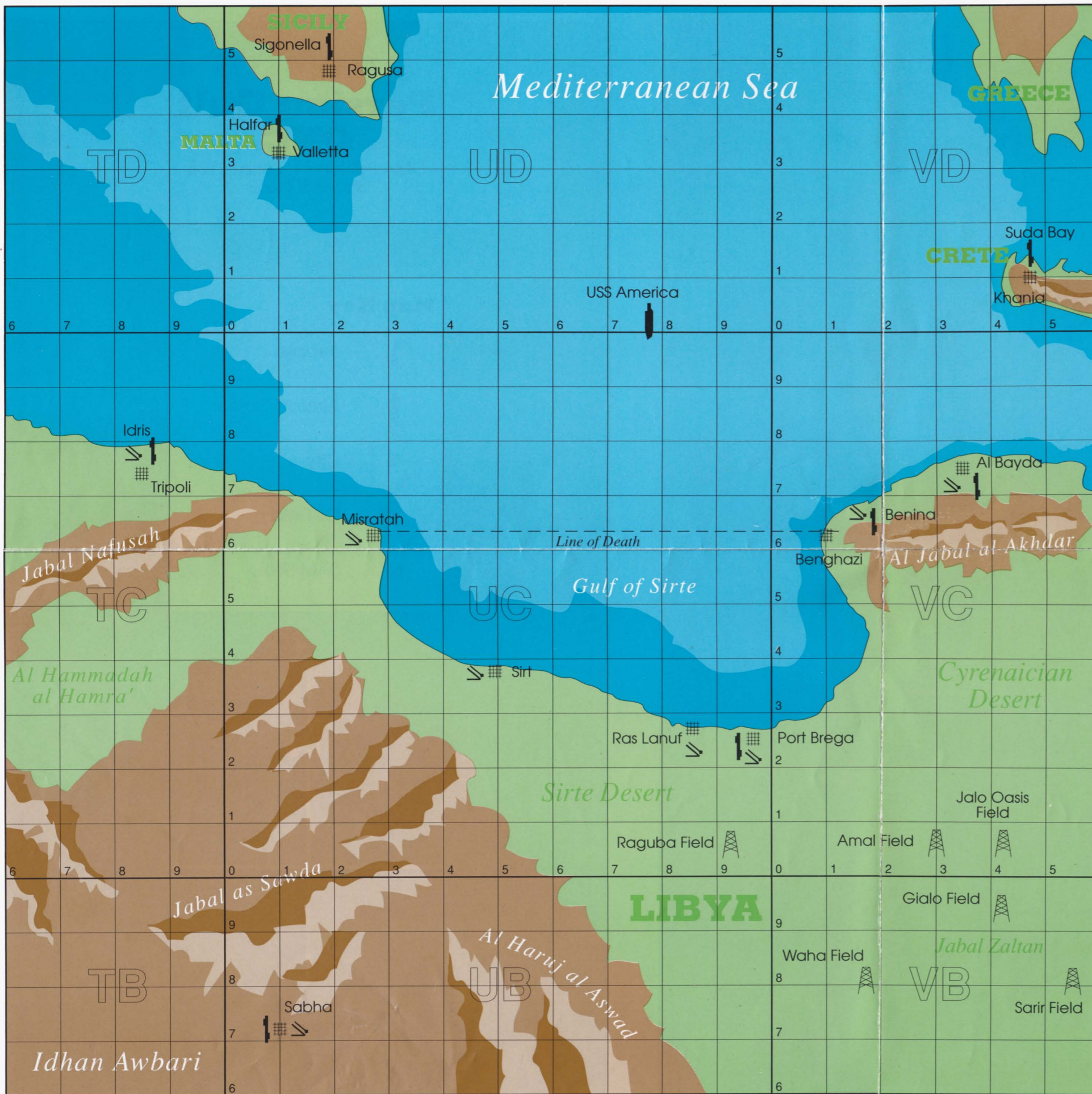

- Airbase
- City
- OTH Radar
- SAM Site
- Pact Armies



Libya ONC

DMA Edition 11, Series 2105
Sheet 35N15E

Map Key

-  Airbase
-  Aircraft Carrier
-  City
-  Oil Field
-  SAM Site

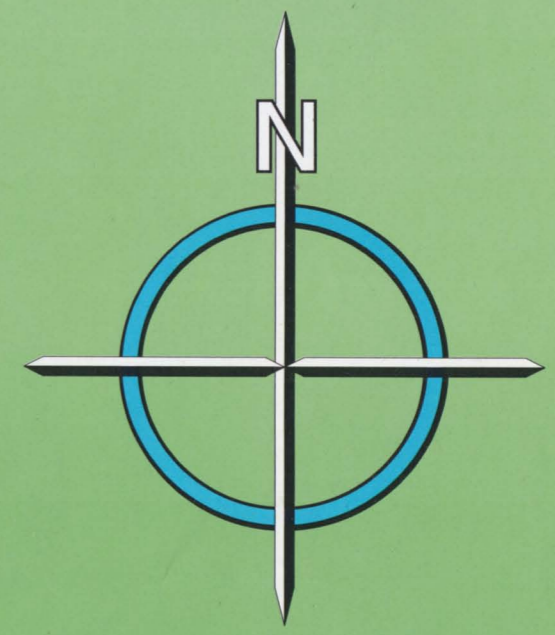









North Cape ONC

DMA Edition 11, Series 2105
Sheet 70N30E

Map Key

-  Airbase
-  Aircraft Carrier
-  City
-  LPAR Radar
-  Naval Base
-  SAM Site
-  Sub Pen

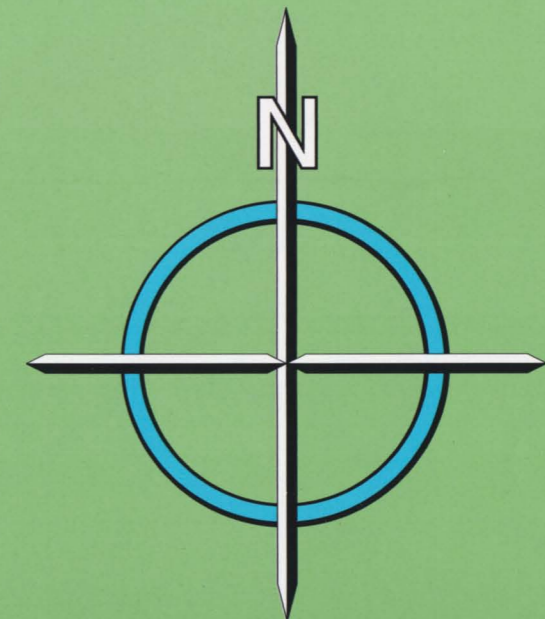







Persian Gulf ONC

DMA Edition 11, Series 2105
Sheet 30N55E

Map Key

-  Airbase
-  Aircraft Carrier
-  City
-  Oil Field
-  SAM Site

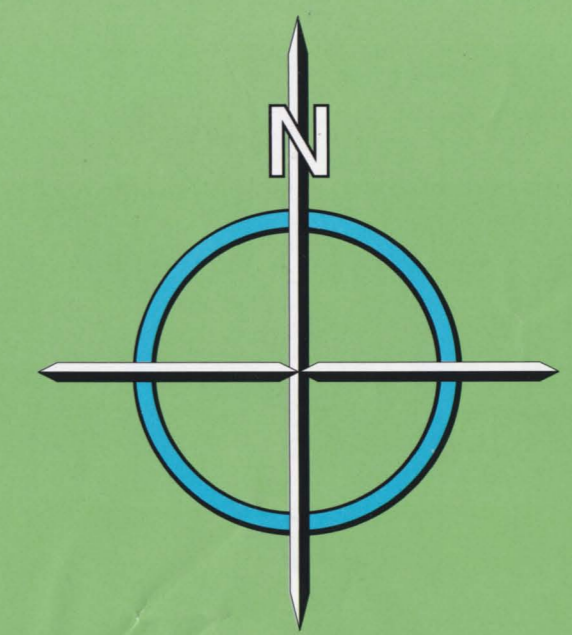

F-19

STEALTH FIGHTER

23 / 4 / 91 TIB

AMIGA

DISK A

MICROPROSE
SIMULATION · SOFTWARE

© 1988, 1990 Microprose Software Inc.

F-19

STEALTH FIGHTER

23 / 4 / 91 TIB

AMIGA

DISK B

MICROPROSE
SIMULATION · SOFTWARE

© 1988, 1990 Microprose Software Inc.