

Vectrex™
ARCADE SYSTEM

SCRAMBLE*

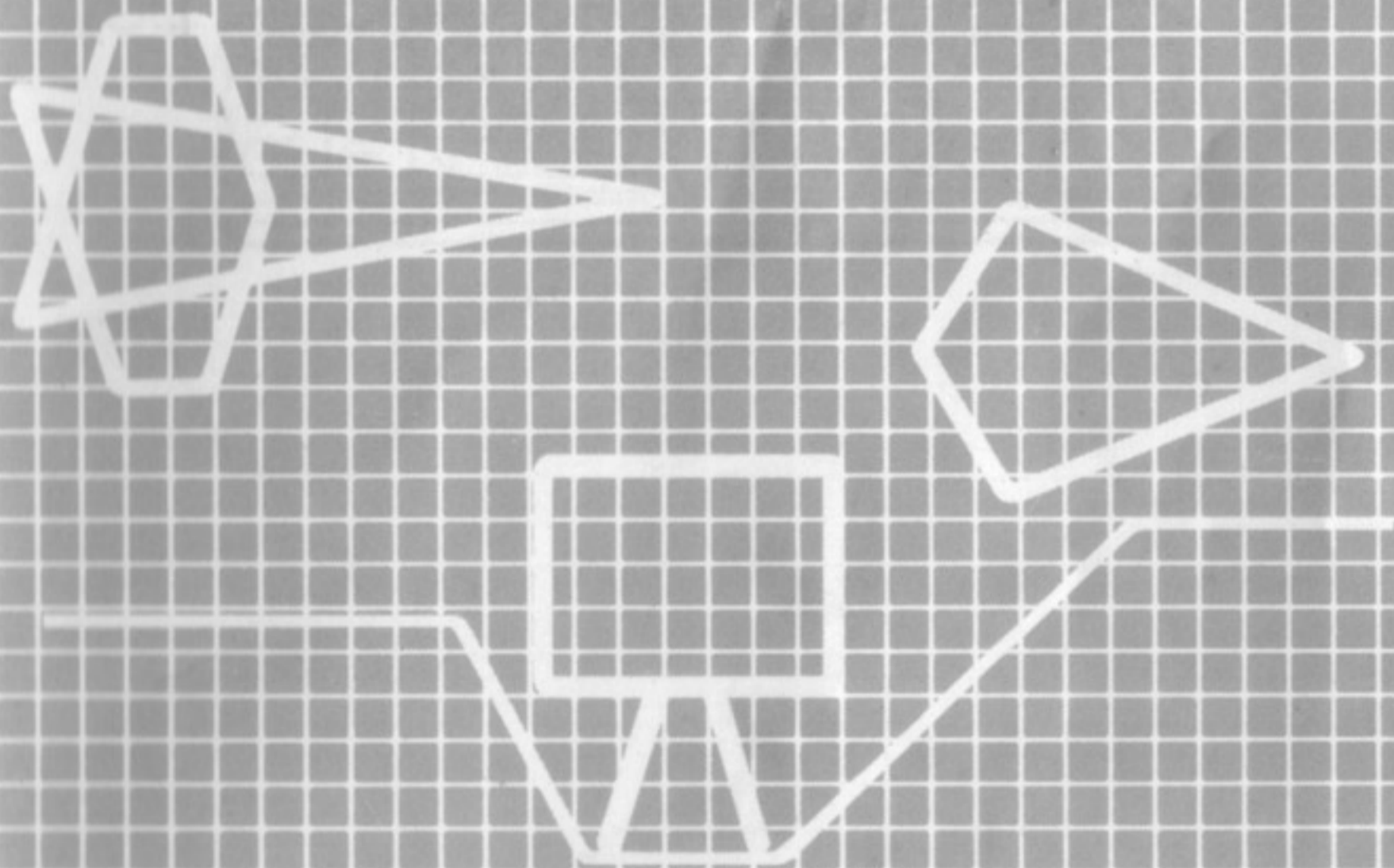

GCE™
ENTERTAINING NEW IDEAS™

© General Consumer Electronics, Inc. 1982. Santa Monica, CA 90401.
All Rights Reserved.

* Designates trademark of Konami Industry.
Manufactured under license from Konami Industry.
Copyright ©1981 Konami Industry.

SCRAMBLE*

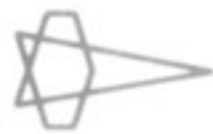
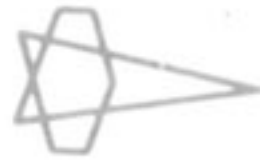
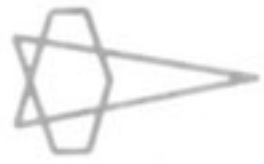

Watch out for that next mountain!
Maneuver your ship over a rough
terrain in an effort to destroy the
enemy base. Careful piloting alone
won't get you to your destination...
You must brave rockets, UFOs,
flamoids and some very tight tunnels.
Few people have ever seen the
enemy base, let alone destroy it. Will
you be one of the select few?

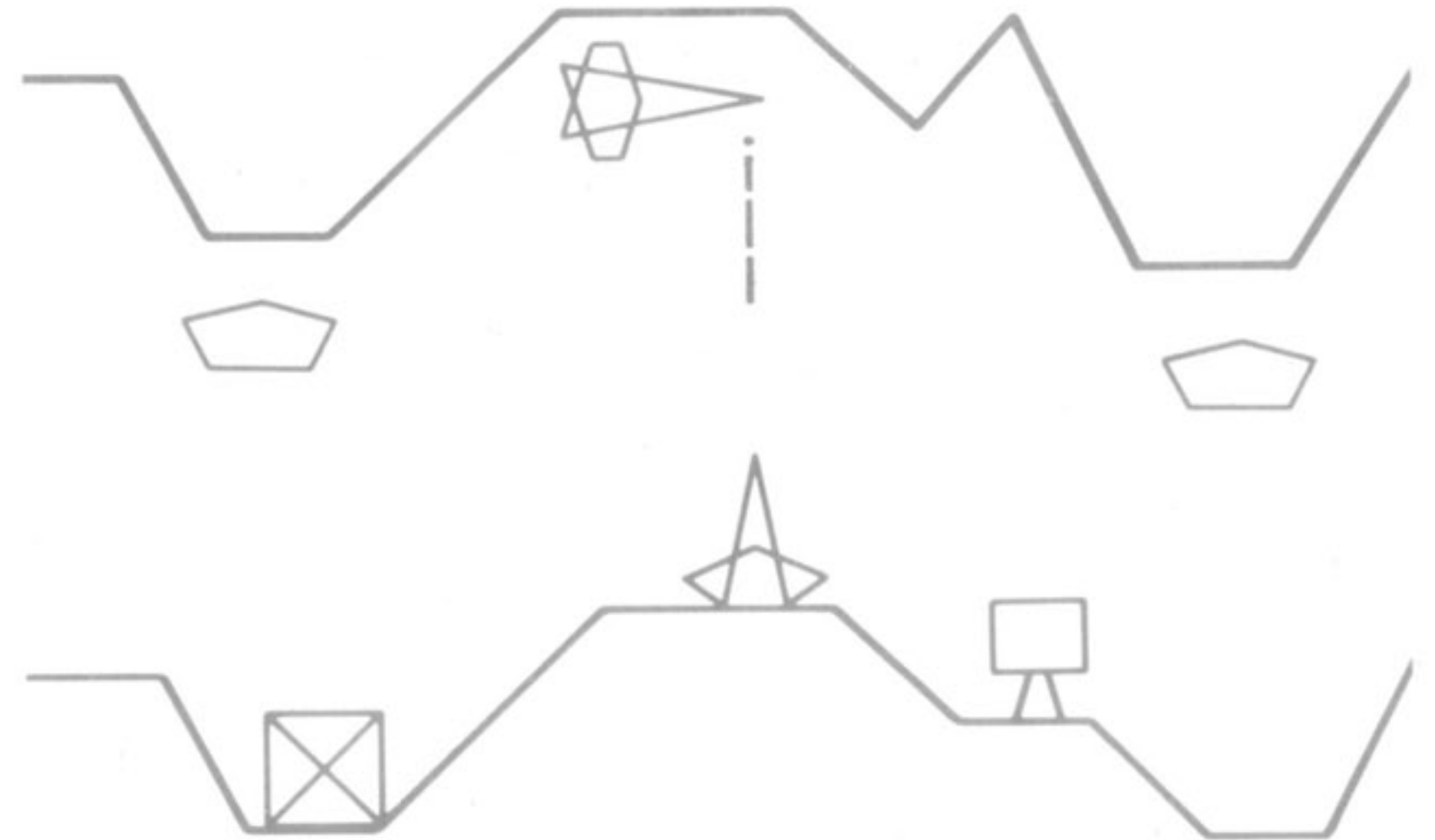

Setting Up

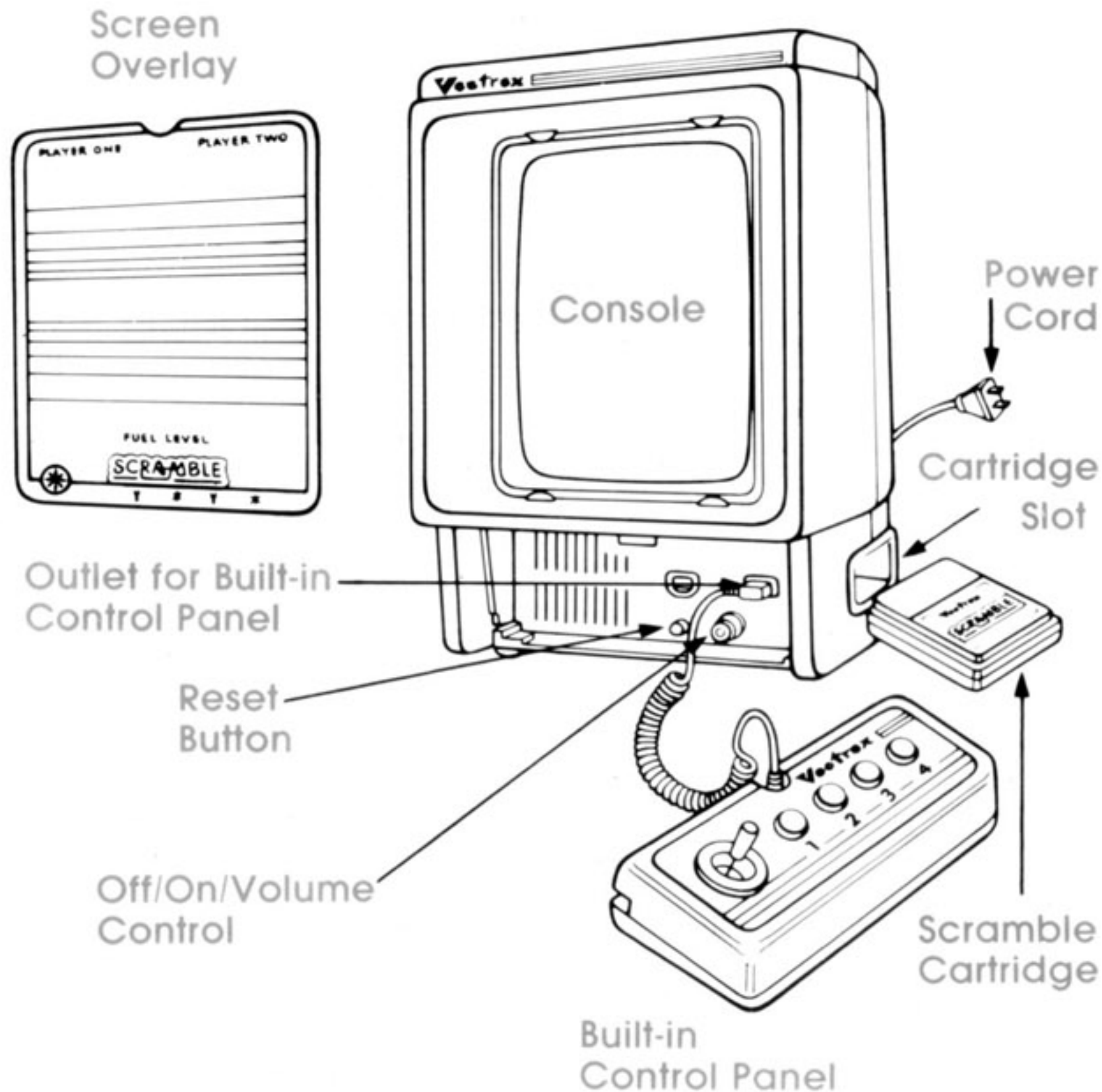

- Make sure the console power cord is plugged into a 120 volt AC 60 cycle electrical outlet.
- Check to be sure the plug for the built-in control panel is firmly seated in the control panel outlet on the right.
- Make sure the console is turned OFF before inserting the cartridge. Insert the cartridge into the slot with the label side up. Be sure it is firmly inserted to the guideline marked on the cartridge.
- Insert the screen overlay behind the tabs at the top and bottom of the screen.
- Turn the OFF/ON/VOLUME CONTROL to the ON position (clockwise). You will see the Vectrex title for a few seconds, then the name of the game.
- Adjust the volume control to the desired listening level.

Scramble Controls

Scramble is designed to be played with the built-in control panel only. The functions of the controls are:

Moves ship up or down, faster or slower. Moves in 8 directions indicated on overlay.

Bomb
Drops bombs on objects below.

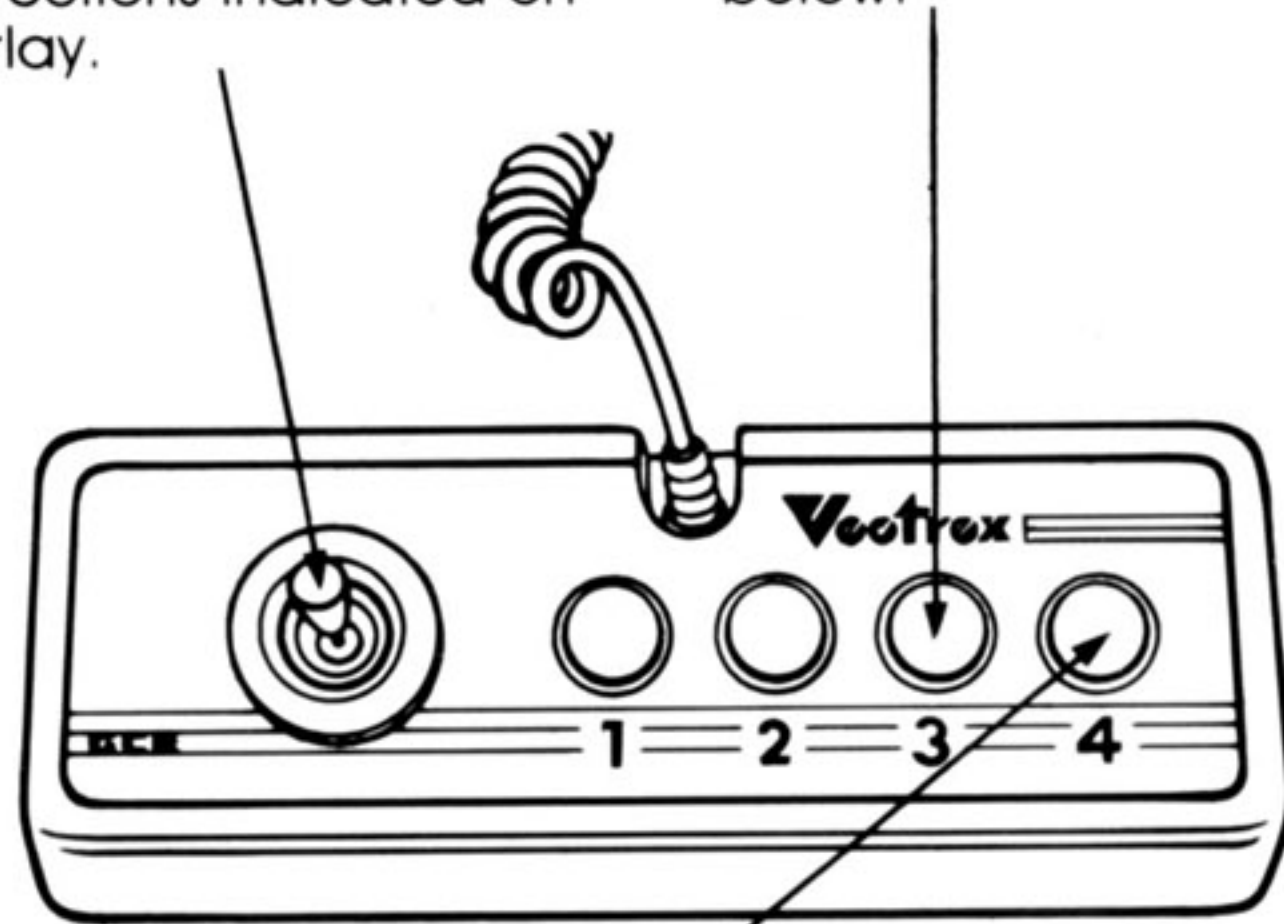

Laser
Shoots lasers at approaching objects.

How To Play

Player Selection

Scramble can be played as a one or two player game. When **PLAYER 1** appears on the screen, press Button 1

1
GAME
1

once to switch to a two player game. **PLAYER 2** will

2
GAME
1

then show on the screen. When played as a two player game, only the built-in control panel is used, and the players take turns using this control panel. You can return to a one player game by pressing Button 1 again before starting game play.

Difficulty Selection

You can select any of 3 difficulty levels when beginning Scramble:

Difficulty Level	Fuel Consumption	Missile Flight	UFO Speed	Maze Width
Game 1	Slow	Straight	Slow	Average
Game 2	Medium	Curves toward you	Medium	Average
Game 3	Fast	Curves toward you	Fast	Tight

Starting Game Play

Once you select the number of players and the difficulty level, press Button 4 to put your first ship in flight.

Game Play

Your ship will immediately come into view and the landscape of the first part of your journey will begin moving beneath you. Use the Joystick to maneuver your ship across the terrain, avoiding the mountains and other obstacles. Press Button 3 to drop bombs. Press Button 4 to fire lasers at the obstacles. If you are successful in piloting through that section of the terrain, you will immediately fly to the next, more difficult part of the planet. If you successfully travel through all levels, you will eventually reach the enemy base.

Joystick

The Joystick lets you control the ship's height and speed. Push the Joystick up and down to control how high you are flying. By moving the Joystick right and left, you can control the speed. You can also move diagonally. You cannot move any further forward than the middle of the screen or any further back than the left side of the screen.

Objects Found on Journey

The various obstacles you will encounter as you head toward the enemy base include:



Missiles



Fuel Tanks



Mystery Bases



UFOs

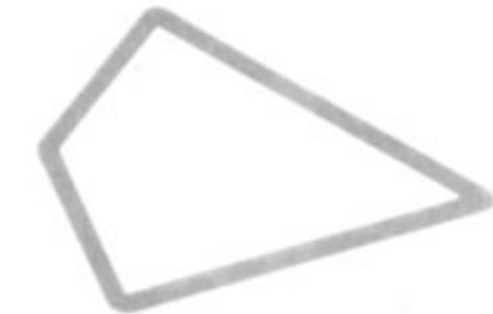

Flamoids

Levels

There are five levels in Scramble which you must survive in an effort to get to the enemy base. The levels are as follows:

- LEVEL ONE:** **The Mountains**
Fly over a mountainous terrain, destroying obstacles. Maneuver carefully . . . surface-to-air missiles will be constantly released.
- LEVEL TWO:** **The Cavern**
Weave your way through a treacherous cavern. Be sure to avoid the floor and ceiling while also avoiding or destroying the UFOs.
- LEVEL THREE:** **The Flamoids**
Careful piloting is required to survive this level. Flamoids are speeding toward you and your bullets and lasers have no effect on them - you can only try to avoid this danger.
- LEVEL FOUR:** **The City**
Climb high over the walls of the city. Watch carefully because missiles hidden in silos may take off and destroy you at any moment.
- LEVEL FIVE:** **The Maze**
This tight maze requires absolute precision to survive. The fuel tanks at the beginning are your last chance to fuel up before tackling the enemy base
- LEVEL SIX:** **The Enemy Base**
Your only objective is to bomb the enemy base. This level will repeat until the base is successfully destroyed.

Fuel

The fuel gauge is at the bottom of the screen. Each of your ships will start with a full tank and you can add fuel by destroying the fuel tanks with bombs or lasers. Each fuel tank is worth 1/8 of your tank. If you start to run low, your fuel gauge will flash and a warning signal will sound. If you do run out of fuel, your ship will crash.

Collisions

If you collide with the landscape or any obstacle, you will lose one ship. You will automatically return to the beginning of the level you were on.

Bombing the Enemy Base

Once the enemy base is hit, the Scramble theme is played and the difficulty of the game is increased further. You will get a full tank of fuel and will automatically advance to Level One again.

Number of Ships

In each game you start with 5 ships. A bonus ship is awarded when you score 10,000 points.

Scoring

As long as you are flying you are awarded 10 points every second. You are also awarded points for destroying the obstacles. The obstacles, their point values and the levels in which they appear are as follows:

Obstacle	Points	Levels
Missile (on ground)	50	1,2,3,4
Missile (in air)	80	1,4
Fuel tank	150	1,2,3,4,5
Mystery Base	200	1,2,3,4
UFO	100	2
Enemy Base	850	6

High Score Memory

As long as your machine is on, with the Scramble cartridge in place, the high score is retained. Once the machine is turned off and the cartridge removed, the high score is lost. To view the high score, press the Reset Button on the console.

Restarting Game

To restart a completed game with the same number of players and with the same difficulty level, press any of the four action buttons once the game is over. If you wish to restart the game before it is completed, or change the number of players or difficulty level, press the Reset Button on the console.

Score Record

Date

Name

Score

_____	_____	_____
_____	_____	_____
_____	_____	_____
_____	_____	_____
_____	_____	_____
_____	_____	_____
_____	_____	_____
_____	_____	_____
_____	_____	_____
_____	_____	_____
_____	_____	_____
_____	_____	_____
_____	_____	_____
_____	_____	_____
_____	_____	_____
_____	_____	_____
_____	_____	_____
_____	_____	_____
_____	_____	_____
_____	_____	_____
_____	_____	_____
_____	_____	_____

Vectrex[™]
ARCADE SYSTEM

GCE[™]
A MILTON BRADLEY COMPANY

9872D-062