

Bally **MIDWAY**™

SPY HUNTER™

OFFICIAL ARCADE GAME



COMMODORE 64™

You are a world class spy driving for your life in your ultra-equipped turbo-charged spy mobile. The road is crawling with Enemy Agents bent on your destruction. They'll stop at nothing . . . so neither can you!

Maneuver your car with all the speed and skill you can, always watching for the Road Lord, the Switch Blade, the Enforcer and other Enemy Agents as they try to stop you cold on land and water. You must destroy them before they destroy you!

USING YOUR CONTROLS

ASSEMBLING SPY HUNTER'S DUAL CONTROL MODULE

To play Spy Hunter on your game system, you must use the Dual Control Module which enables you to join your two joysticks together in one unit. This is necessary because Fire Buttons on both joysticks are needed to play Spy Hunter.

Diagram 1

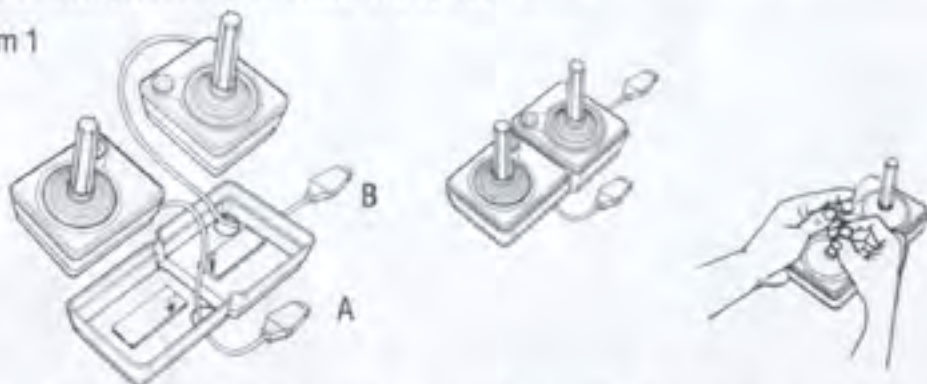

1. Holding the Dual Control Module with the cable openings in the position shown in diagram #1, guide the joystick cable A through the opening closest to you.
2. Peel back the paper covering the Velcro™ attachment and as you pull the cable slack, press the #1 joystick firmly into place with that joystick's Fire Button in the upper left hand corner, as shown in the diagram.
3. Now guide the cable for joystick #2 through the cable opening at the upper left hand corner of the Dual Control Module. Peel the paper covering the Velcro™ attachment. Again, as you guide the cable all the way through the opening, press the #2 joystick firmly into place inside the Dual Control Module. Make sure that the Fire Buttons on the joysticks are side-by-side toward the front, according to the diagram.
4. Plug the cable for joystick #1 into joyport #1. **THIS IS THE ACTIVE JOYSTICK** which controls the movement of your Spy Car.
5. Plug the cable for joystick #2 into joyport #2. **THIS JOYSTICK PROVIDES AN ADDED FIRE BUTTON ONLY.**

When playing Spy Hunter, hold the joysticks vertically, with joystick #1 (the active joystick) at the bottom and joystick #2 above it. You use only joystick #1 to maneuver your Spy Car. Both Fire Buttons are used for activating your Spy Weapons.

6. To pause game, press F7 key.
Other key functions: F1-Restart F3-Reset Option RESTORE-Reset to title page
IMPORTANT: Depress the key you choose and HOLD IT DOWN.

SET UP AND GAME CONTROL

1. Insert the game cartridge or diskette while power is OFF.
2. Turn the power ON.
3. FOR THE DISKETTE, type: LOAD "SPYLOADER", 8,1
When it is ready, type RUN.
FOR THE CARTRIDGE: the game takes about 10 seconds to load after you turn the power ON.
4. Then, for the cartridge or diskette, select either J (joystick) or K (keyboard) and E (expert), the more challenging game, or N (novice), the easier game, by using the keyboard. The NOVICE game runs on a counter that gives you 999 units to complete the first leg of the course. You have an unlimited number of Spy Lives (cars) during this time. After the period is completed, you earn one extra Spy Car. You earn another Spy Car after 20,000 points and one every 10,000 thereafter.
The EXPERT game also starts with an initial 999 counter, but at a higher difficulty level. The enemy is more aggressive and you are given one Spy Car after the counter runs down. You earn another Spy Car at 20,000 points, then one every 20,000 thereafter.

5. You'll hear the Spy Hunter theme as the Weapons Van pulls onto the side of the road, letting your Spy Hunter car roll out the back and onto the road.

6. Use your bottom joystick control to maneuver your Spy Car through the dangers of the road and waterways of Spy Hunter in the following way:

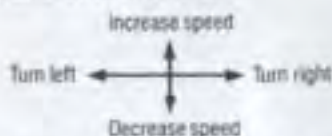

7. If you wish to play Spy Hunter using keyboard controls rather than the joysticks, here are the keys to use:

Up—I	Left—J	Fire forward—A
Down—K	Right—L	Fire backward—Z

8. Spy Hunter's special Dual Control Module enables the player to activate both Fire Buttons easily. Only the bottom joystick affects the movement of your Spy Car. However, both Fire Buttons are used to activate weapons. The bottom Fire Button activates forward firing weapons. The top Fire Button activates rear firing weapons. (See Weapons Section.)

HOW TO PLAY

SCREEN AND GAMEPLAY

Your Spy Hunter adventure starts as the Weapons Van rolls up from the bottom of the screen and pulls over to the shoulder of the road. The van stops and your Spy Car rolls out the back, armed with machine guns. You then maneuver your car onto the road as the action begins.

The road will branch and fork as you go. You must be careful as you dodge and chase enemy agents not to swerve off the road. If you do, you'll lose one of your Spy Cars. When you lose a Spy Car and you still have Spy Cars in reserve, a Weapons Van appears from the bottom of the screen and pulls onto the road shoulder to let the new Spy Car roll out the back

and onto the road for more action. If you have no remaining Spy Cars, the game is over.



The terrain will change as you traverse the course. Screen backgrounds will change color as indication of a new terrain. As the course continues, you'll come to a waterway. Here your Spy Car enters a boathouse and automatically becomes amphibious and skims along the surface of the water. Don't think you're safe. The water is teeming with other Enemy Agents.

There is also a stretch of bridges and a stretch of Icy Road in other screens. On the Icy Road, the surface is slippery and your car is harder to control.



WEAPONS

Each time you enter a new terrain the Weapons Van appears on the side of the road, ready to supply your Spy Car with the appropriate new weapon. To gain access to the new weapons, you must "dock" with the Weapons Van. To do this, allow the Van to pass you, then get behind it and drive up into it. The Van will automatically let the Spy Car roll out once the

weapons have been transferred.

Here's how to activate your various weapons:

Joystick—Bottom Fire Button activates Machine Gun and Missiles

Top Fire Button activates Smoke Screen and Oil Slick

Keyboard—"A" activates Machine Gun and Missiles

"Z" activates Smoke Screens and Oil Slicks

The weapons you have available to you at any given time are displayed at the bottom right of the screen.

You can also use your Spy Car to destroy some enemy agents by ramming them off the road for points.

ENEMY AGENTS

The Spy Car faces various Enemy Agents along the course. Each Enemy Agent, except the Road Lord, has its own unique weaponry. They are:

 The Road Lord (bulletproof)
Must be rammed off road by Spy Car

 The Enforcer
Fires a shotgun

 Switch Blade
Extended buzz-saw hubcaps to slash cars

 The Copter (Mad Bomber)
Drops bombs onto Spy Car

 Barrel Dumper
Dumps barrels in water ahead of Spy Boat

 Doctor Torpedo
Fires torpedos at Spy Boat

Running off the road, or running into a screen boundary, at any time will also cost you a Spy Car.

SCORING

The player's score is displayed at the bottom left corner of the screen. Current High Score is displayed on the menu screen.

Here's how the scoring adds up:

Travelling on the water15 points for every 1/4 of screen
Travelling on the road25 points for every 1/4 of screen

If you destory:

The Road Lord150 points
Switch Blade150 points
The Enforcer500 points
The Copter (Mad Bomber)700 points
Barrel Dumper150 points
Doctor Torpedo500 points

Each time you enter or exit the boathouse, as you move from land to water and back again, you earn 1500 points.

MORE GREAT ARCADE GAMES FOR THE HOME

SEGA STAR TREK STRATEGIC OPERATIONS SIMULATOR



Sega, the arcade winners, take you where no video game has dared to go before with STAR TREK—STRATEGIC OPERATIONS SIMULATOR. Take command at the helm of the U.S.S. Enterprise as you train for your super challenging space mission.

Destroy deadly KLINGONS and ANTI-MATTER SAUCERS as you gain the nerve and skill to be victorious against the Federation's most awesome

enemy... the mine-laying NOMAD!

Now all the action and adventure of STAR TREK zooms right into your home. Control the STAR TREK—STRATEGIC OPERATIONS SIMULATOR and feel the thrill of maximum space challenges... but remember only you can save the Federation!

OFFICIAL ARCADE VERSION



SEGA Congo Bongo™



You can hear the beat of jungle drums in the fun-filled cartoon adventure, CONGO BONGO. Colorful, state-of-the-art, 3-D graphics burst on the screen as your Jungle Adventure hunts down Congo Bongo, the mischievous giant gorilla.

There are plenty of thrills and challenges along the way: huge cliffs, coconuts, pesky chimps, treacherous lakes and mean, charging rhinos. CONGO BONGO—more fun than a barrel of monkeys... or gorillas!

OFFICIAL ARCADE VERSION



SEGA[®] BUCK ROGERS[™] PLANET OF ZOOM

Now, bring the 25th century into your home with the thrilling new home version of the arcade favorite, Buck Rogers—Planet of Zoom.

Fight the Battle of Planet Zoom. Skimming the surface of the planet you slip through deadly Electron Posts and smash enemy Space Hoppers. Penetrate waves of Alien Saucers as you blast deeper into space to do battle with your most powerful and cunning enemy... the MOTHER SHIP!



- ONE PLAYER COSMIC COMBAT
- EXPLOSIVE 3-D COLOR GRAPHICS
- THREE GALACTIC SCREEN DISPLAYS
- FAST PACED TIMED ACTION
- DEMANDING PILOT SKILLS AND CHALLENGES
- JOYSTICK CONTROLS

Now you can experience the thrills and challenges of cosmic combat like never before... after all who knows space better than Buck Rogers and who knows great games better than SEGA!

OFFICIAL ARCADE VERSION

SEGA[®] ZAXXON

- THE OFFICIAL HOME COMPUTER VERSION OF SEGA'S CLASSIC ARCADE GAME
- UNIQUE COLOR GRAPHICS
- 3-DIMENSIONAL SCROLLING BATTLEFIELD COMPLETE WITH ENEMY AIRCRAFT, FUEL TANKS, ANTI-AIRCRAFT TANKS
- NERVE-RATTLING SOUND EFFECTS
- INCLUDES DEADLY ZAXXON ROBOT ENCOUNTER



ZAXXON thrusts you into the depths of outer space. Test your pilot skills as you strap into the command position. Prepare for an action-packed challenge of space survival.

Score points as you dive, climb, and swoop down to destroy the enemy's floating fortress. Dodge deadly laser barriers, enemy missiles, and rapid gunfire! Destroy enemy fuel tanks and your own supply is replenished. Survive the enemy's fighter fleet attack and face the ultimate challenge... the powerful, armored ZAXXON ROBOT.



Bally MIDWAY.

Up'n Down™

FUN IN THE FAST LANE

- The Official Home Version of the Bally/Midway Arcade Winner
- Multiple screens of Baja Road Race excitement
- High-speed challenges for one or two players
- Full-throttle color action-animated graphics

Drive your Baja Buggy over treacherous miles of deadly roads. Watch out!

The course is crawling with opponents who want to make this the last race you run. Beware of killer pick-up trucks, boulders, and swarms of other motoring menaces.

OFFICIAL ARCADE VERSION



Bally MIDWAY.

TAPPER™

SIDE-SPLITTING, SODA-SLINGING LAUGHS AND SPILLS!

- The Official Home Version of Bally/Midway's Arcade Sensation
- Three belly-busting screens of Soda Fountain Fun, including:
 - Four mad-capped bar rooms of soda-starved, clammering cowboys, sports fans, punks and space creatures
 - Plus a head-spinning



Soda Bandit Bonus Round

- Awesome color-packed action graphics
- Just try to keep your cool as hot-headed, crazy customers blitz your bar for another cold one.

OFFICIAL ARCADE VERSION



SPY HUNTER is a trademark of Bally Midway Mfg. Co. Video game copyright © 1983 Bally Midway Mfg. Co. All rights reserved. BALLY/MIDWAY is a trademark of Bally Midway Mfg. Co. Commodore 64 is a trademark of Commodore Electronics, Inc. Package and program copyright © 1984 Sega Enterprises, Inc. STAR TREK is a trademark of Paramount Pictures Corporation. CONGO BONGO and ZAXXON are trademarks of Sega Enterprises, Inc. BUCK ROGERS is a trademark of The Dille Family Trust. UP 'N DOWN is a trademark of Sega Enterprises, Ltd. TAPPER is a trademark of Bally Midway Mfg. Co.

PUBLISHED BY
SEGA[®]
ENTERPRISES, INC.