

Sid Meier's

CIVILIZATION™

Build An Empire To Stand The Test Of Time

MICROPROSE™
SIMULATION • SOFTWARE

EmuMovies

Sid Meier's
CIVILIZATIONTM
Build An Empire To Stand The Test Of Time



MICRO PROSETM
ENTERTAINMENT • SOFTWARE

CIVILIZATIONTM

Computer Simulation

MicroProse Software
180 Lakefront Drive, Hunt Valley, MD 21030
(301) 771-1151

All rights reserved.
Copyright © 1991 MicroProse Software, Inc.

This book may not be reproduced in whole or in part by mimeograph or any other means without permission, with the exception of quoting brief passages for the purposes of reviews.

Printing History
First Printing 1991
Printing: 9 8 7 6 5 4 3 2 1

Civilization is MicroProse Software's trademark for its simulation of Human History.
IBM is a registered trademark of International Business Machines, Inc.
Tandy is a registered trademark of Tandy Corporation.
AdLib is a registered trademark of AdLib Incorporated.
Roland MT-32 is a registered trademark of RolandCorp, USA.
Apple and Macintosh are registered trademarks of Apple Computer, Inc.

CREDITS

GAME DESIGN

Sid Meier
with Bruce Shelley

ORIGINAL IBM PROGRAMMING

Sid Meier

ORIGINAL IBM COMPUTER GRAPHICS

Michael Haire
Harry Teasley
Barbara Bents
Todd Brizzi
Stacey Clark
Brian Martel
Erroll Roberts
Nicholas Rusko-Berger

ORIGINAL IBM MUSIC COMPOSITIONS

Jeffery L. Briggs

CIVILOPEDIA

B.C. Milligan
Jeffery L. Briggs
Bruce Shelley

ORIGINAL IBM SOUND EFFECTS

Ken Lagace
Jim McConkey

DOCUMENTATION

Bruce Shelley

EDITORS

B. C. Milligan
Paul Murphy

MANUAL DESIGN

Susan Ullrich
Iris Idokogi

MANUAL LAYOUT

Terry Rund

ILLUSTRATIONS

Laurie Baker

MANUAL GRAPHICS

Susan Ullrich
Terry Rund

PACKAGE DESIGN

Moshe Milich

ORIGINAL VERSION QUALITY ASSURANCE

Al Roireau
Chris Taormino
Tim Train
Chris Clark
Mike Corcoran

ADDITIONAL PLAYTESTING

Arnold Hendrick
Sandy Petersen
Jim Synoski
Scott Patterson
B. C. Milligan
Doug Whatley
Paul Murphy

TABLE OF CONTENTS

TITLE PAGES	1	Settlers, Soldiers, and Envoys	33
GAME CREDITS	3	Movement	33
TABLE OF CONTENTS	4	Combat	35
1. INTRODUCTION	7	Additional Orders	36
Introduction	7	Settlers	37
Cities and Civilizations	9	Diplomats	37
Before You Start	13	Caravans	39
Interface Introduction	14	Military Units	40
Pre-Game Options	16	Barbarians	42
The Game Turn	18	Governments	43
Date	18	Types	43
Disasters	18	Revolution	45
City Check	18	Advisors/World Reports	46
Movement and Combat	19	City Status	46
End of Turn	20	Military Advisor	46
Adulation	20	Intelligence Advisor	47
Ending the Game and Winning	22	Attitude Advisor	47
Ending Play	22	Trade Advisor	47
Winning	23	Science Advisor	48
The Hall of Fame	23	Wonders of the World	48
2. THE WORLD	25	Top 5 Cities	49
The World Map	25	Civilization Score	49
World Geography	25	World Map	49
Special Resources	27	Spaceships	50
Minor Tribes	27	Demographics	50
The Map Display	28	Civilopedia	51
Map Window	28	Planetary Caretaking	52
World Window	29	Industrial Pollution	52
Menu Bar	29	Cleanup	52
Palace Window	30	Effects	52
The Status Report	31	Monitoring Pollution	53
Unit Identification Window	32	Global Warming	53
		Nuclear Pollution	54

Diplomacy	55	4. THE DYNAMICS OF CIVILIZATION	91
Peace	56	Introduction	91
The Space Race	57	The Advance of Knowledge	93
Spaceships	57	5. ADDITIONAL NOTES	111
Construction	58	Leader Biographies	111
Components	58	Players' Notes	116
Modules	59	Designers' Notes	122
Structures	59	Further Reading	124
3. CITIES	61	Index	125
Cities	61	Copyright Notice/Warranty	127
New Cities	61	Civilization Advances Chart	129
Placing New Cities	62		
City Management	63		
City Protection	65		
Civil Disorder	66		
We Love the (King) Day	66		
The City Display	68		
City Map	69		
City Resources Window	69		
Population Roster	71		
Specialists	72		
Food Storage Box	73		
Production Box	73		
Improvements Roster	74		
Home City Roster	75		
Information Window	75		
City Improvements	78		
Wonders of the World	82		
Construction	82		
Effects	83		
Antiquity	83		
The Middle Ages	84		
The Industrial Age	86		
Disasters	88		

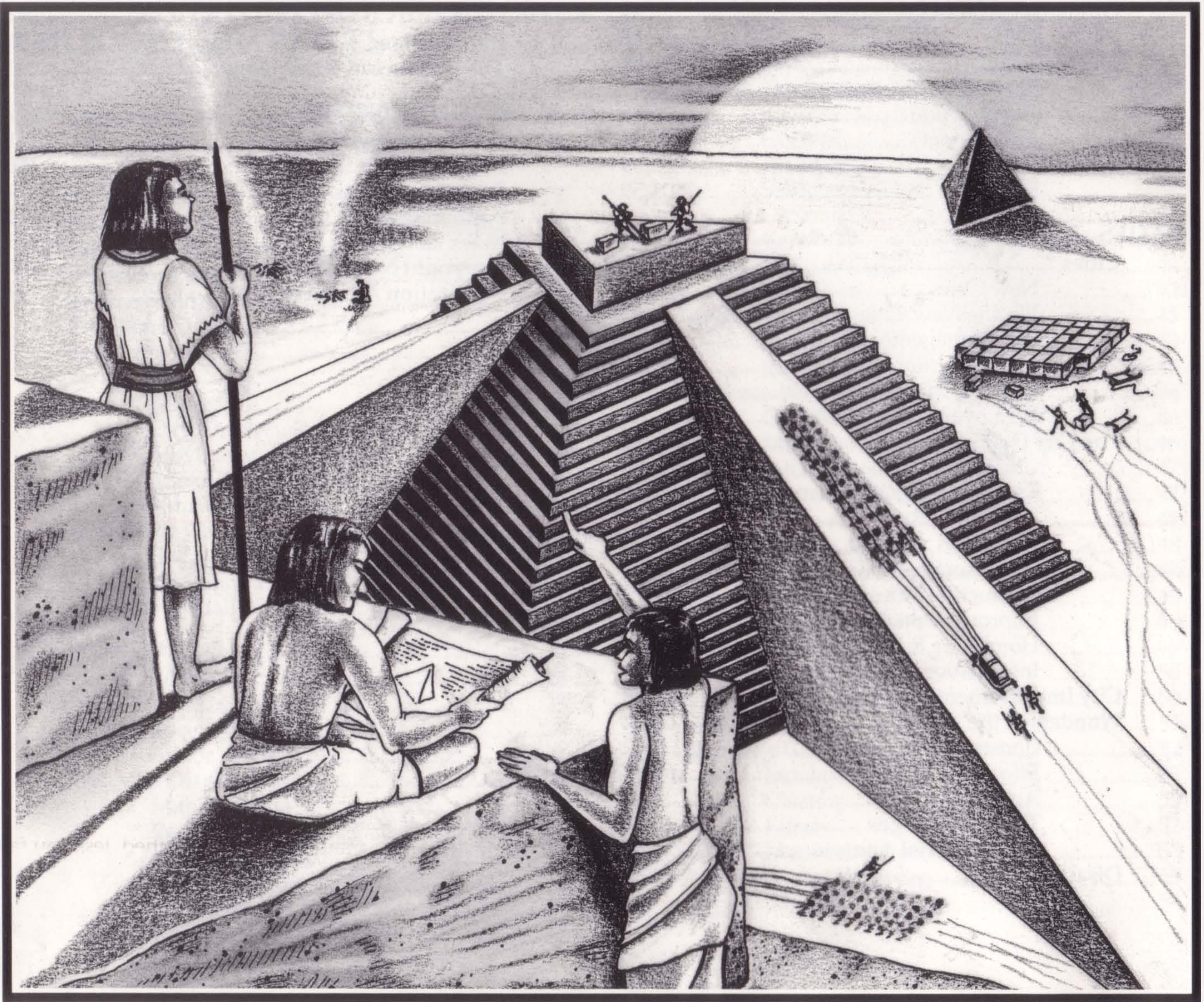

1. INTRODUCTION

INTRODUCTION

Civilization casts you in the role of the ruler of an entire civilization through many generations, from the founding of the world's first cities 6,000 years in the past to the imminent colonization of space. It combines the forces that shaped history and the evolution of technology in a competitive environment. You have great flexibility in your plans and strategies, but to survive, you must successfully respond to the forces that historically shaped the past.

When play begins, your civilization is small and requires only a few decisions each turn. But each decision can have important ramifications later. A number of innovative displays make it easy to understand the issues and implement action. If you prove an able ruler, your civilization grows larger and even more interesting to manage. Inevitable contact with neighbors opens new doors of opportunity: treaties, embassies, sabotage, trade, and war.

As time passes, the number of important decisions required each turn increases. First you must think tactically: location of cities, production of military units or city improvements, exploration of the immediately surrounding lands. Soon, strategic plans must be formulated: war or peace with immediate neighbors, when to explore and expand overseas, when to change your type of government, where to focus technological research.

The success of the civilization that you build depends upon your decisions. As ruler, you manage the economy, diplomacy, explorations, technology research, and war machine. Your policies must be flexible in an evolving world. Military units inevitably become obsolete and need replacement as more advanced technologies appear. The balance of power among your rivals can shift. Economic and governmental policies may have to be modified, lest you fall behind in critical technologies.

Advanced Flight
(Flight & Electricity)

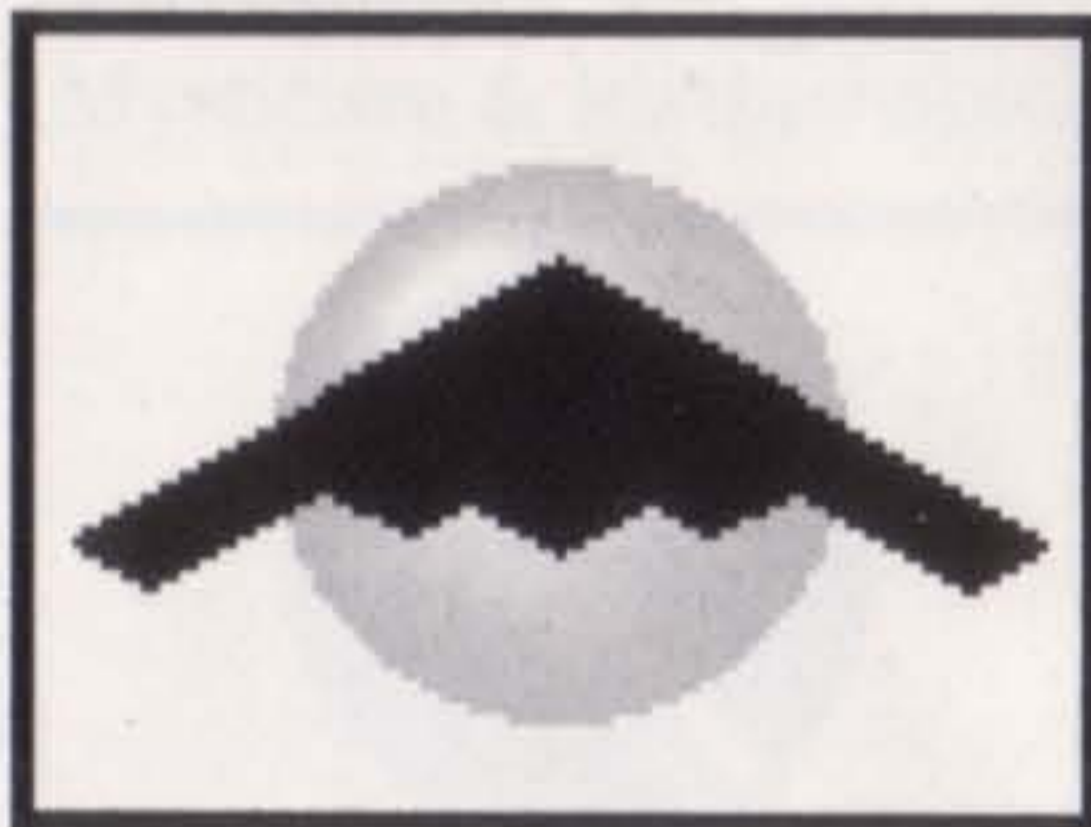

Bomber Unit



Carrier Unit

The past civilizations of Alexander the Great, the Hittites, Napoleon, Genghis Khan, and others all held pride of place on the world's stage at one time, but all eventually collapsed. You are challenged in *Civilization* to build an empire that stands the test of time. You may succeed where your predecessors failed. If you locate cities properly, build them soundly, defend them aggressively, and neutralize the danger from potential enemies, the descendants of your tribe may not only survive, but lead the colonization of space.

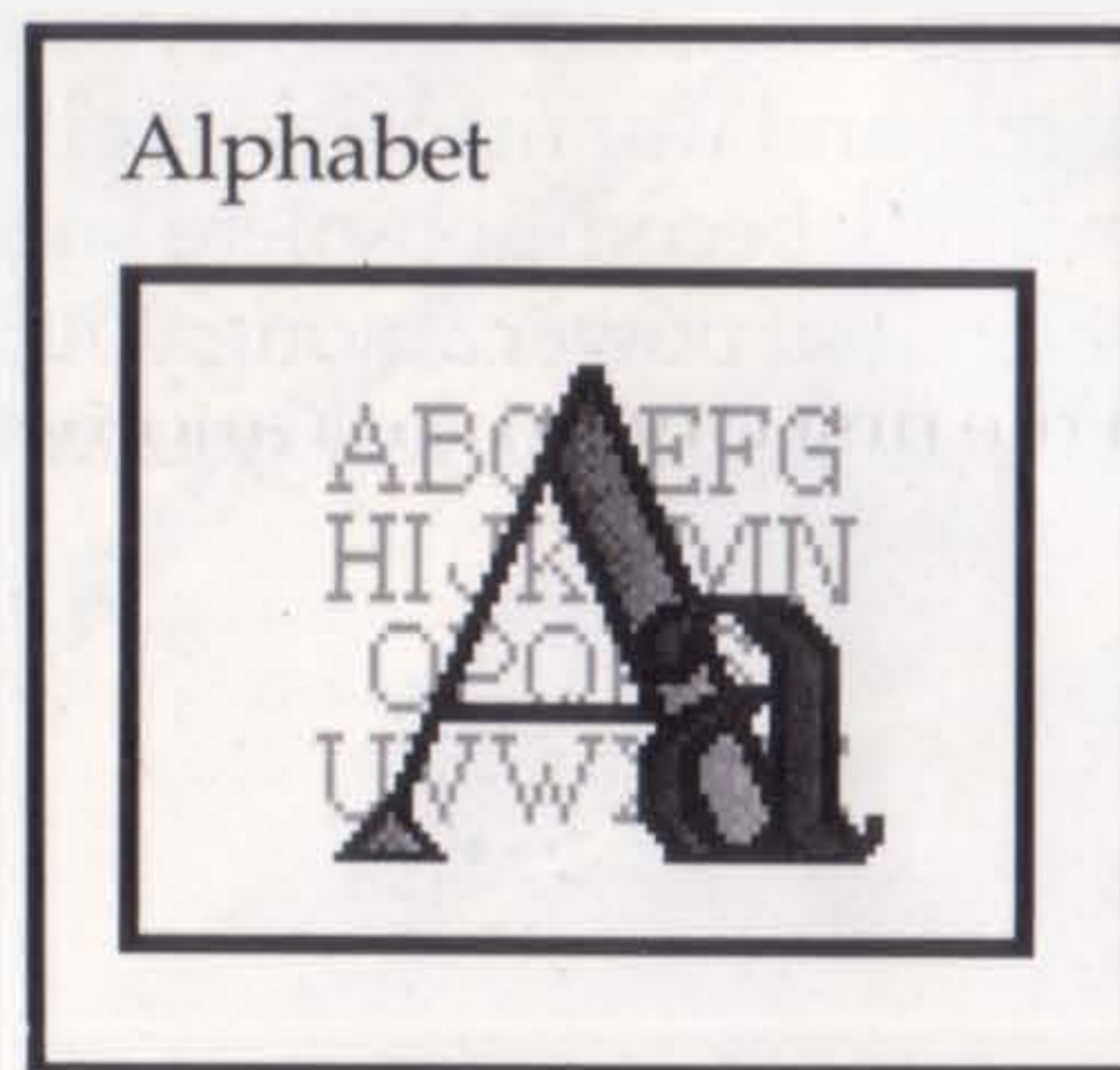

CITIES AND CIVILIZATIONS

Civilizations appeared as agriculture and technology developed to the point where humankind could gather and live in cities. With only part of the population needed to provide food for all, the rest could afford to specialize in the tool making, trading, engineering, and managing that urbanization made possible. Specialization improved efficiency and production. Cities encouraged a rapid exchange of ideas. A teacher could reach many students at once, not just a few.

City residents cultivated the nearby fields, logged the forests, and gathered fish from the rivers, returning each night with the result of their labors. This produce and raw material was bartered in the city markets for the goods and services of others. Charcoal from one area and iron ore from another might be taken to the town smelter who made the iron that the blacksmith turned into tools.

But cities developed unique problems. As they grew in size it became more difficult to provide sufficient food from nearby farmland. Overcrowding, menial jobs, and living conditions often led to unrest among the poorer citizens. Prosperous cities became tempting targets for rival civilizations and barbarian invaders. Cities and civilizations that developed better management and new solutions to these problems grew and prospered. Those that failed have left their ruins around the world as warnings.

In *Civilization*, as in history, a key step and a fundamental concept is the founding and management of cities. The civilization that you are to rule begins as a prehistoric wandering tribe that has just reached that critical point where it is capable of building cities. The first step is to build one city and from there expand. As your civilization grows, cities will spread over an entire continent, or part of a continent, or over several islands and continents.

Each city acts as a giant processing plant for the food, resources, and trade of the adjacent lands. The people of a city go out and work the nearby farmland, mines, and forests, and the city converts the result of their labor into more people, armies, cash, luxury goods, temples, universities, etc. Raw materials are transformed by cities into the power and the ideas your civilization needs to prosper.

Food that is collected feeds the local population. When there is a food surplus the population grows. Your first city has a small population that can only work part of the lands the city controls. As the city population grows, more lands can be worked, increasing production. Before long you can afford to send off settlers from the first city to build another nearby, and then another.

Astronomy
(Mysticism & Mathematics)



Copernicus's
Observatory

Resources are the lumber, metals, energy sources, and other raw materials that are used in industry. Through the craftsmen and shops of the city these resources are made into items useful at home or elsewhere in your civilization. Larger cities normally generate more resources and thus build things faster. Each city can build only one item at a time. This could be a military unit such as a Phalanx or Battleship, a city improvement such as a Temple or University, or perhaps a Wonder of the World.

Trade is generated by the highways of commerce: roads, rivers, and oceans. All nearby trade passes through the city bringing in luxury goods, cash, and new ideas. Your policies can adjust how trade is divided among luxury goods, cash, or research. There may be times when a city requires more luxury goods to make more people happy, or times when more tax revenues are needed in the treasury. Higher taxes mean more revenue but may result in more people becoming unhappy.

As your cities grow they may require more care in keeping them productive. Large cities are desirable for production, but have inherent problems. A critical one you must deal with is the happiness of the population. The people can range from happy, to content, to unhappy. Having too many unhappy people may lead to revolt.

Luxury goods make people happy but may mean fewer tax revenues or a reduced flow of technology. By adjusting the flow of luxuries, changing types of government, building city improvements, instituting martial law, and other means, it is possible to keep even the largest city content and productive.

Technology is a second concept fundamental to *Civilization*. To make the transition from wandering hunter-gatherers to city dwellers, humankind had to possess some essential knowledge and skills. To advance beyond the first stages of city dwelling requires a corresponding advance in knowledge.

At the start of *Civilization*, with your tribe poised on the threshold of history, they already possess some basic knowledge. The people understand agriculture, irrigation, construction of roads, and the construction of homes and other buildings. But this isn't enough knowledge to survive through the coming ages. Learning new technologies opens the door to new abilities. A small island-bound civilization that learns Map Making can now build ships and expand overseas.

The time it takes to acquire new technology depends on how much of your trade is allotted to new ideas. You must choose between luxuries that make the people happy, cash for the treasury, and technology research. The more trade allocated to this research, the faster the next step is acquired. When enough research has been done, your civilization acquires the new technology and can begin working on something new.

The world where your civilization exists is mostly unknown to you, a mystery except in the immediate vicinity. To find out more about it you must explore. Not only is the world hidden, but also unknown are the locations of other civilizations.

Atomic Theory
(Theory of Gravity & Physics)

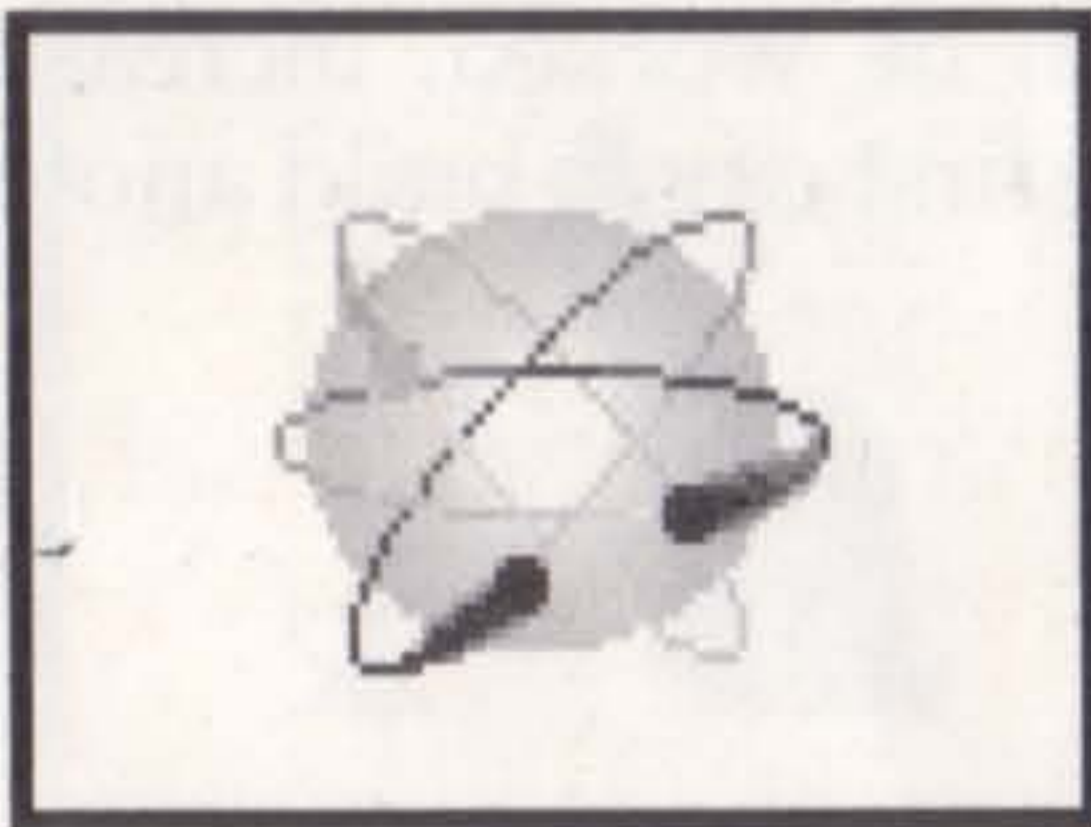

Other civilizations, especially those nearby, complicate your tasks as ruler. Each is ruled by one of your peers, and they are competing for the same resources and opportunities as you. They also are looking to expand and grow; at your expense if given the chance. Once contact is made, you can no longer concentrate solely on the growth and expansion of your civilization. Now you must assess the strength of rivals, adequately provide for the defense of your cities in case of war, or consider making war yourself.

Successful wars can be very useful. Capturing cities is much easier than building them up from nothing, and may provide loot in stolen technology and cash. Weakening rivals reduces the threat they pose. However, long, costly wars may allow unengaged rivals to expand and grow in strength while you spend resources on arms.

To explore the unknown and contend with your rivals for the world, you can build armies, navies, and other special units in your cities. Once an army or naval unit has been built, it is available for movement and combat. These units extend the power of your civilization around the world. When they enter hidden areas of the world, the shroud of mystery is removed and that area becomes known. In this way you uncover the world, finding suitable areas for new cities and eventually making contact with other civilizations.

Three special units are available that can be useful to you as ruler. *Settlers* are groups of your citizens that are your pioneers. They may found new cities and also build terrain improvements such as roads, irrigation, and mines that increase the productivity of your cities. *Diplomats* are your emissaries and spies. They can establish embassies with rivals and also perform a number of cloak and dagger tasks. *Caravans* are bands of merchants that transport the produce of your cities around the world to other cities, bringing in cash and establishing trade routes. Trade routes increase the trade of the home city, resulting in more cash, luxuries, and technology.

Wonders of the World are unique city improvements, usually structures, that can only be built once in the entire world. Once a particular Wonder is built by a city, no other city can build one. Each Wonder brings glory to the civilization owning it, and some unique tangible benefit as well. For example, if one of your cities builds the Oracle, then all of the Temples throughout your civilization become twice as effective in making the people content.

The fundamental concepts for a successful civilization are the expansion and growth of your cities, and acquiring new technology. In a word, you must grow. In this dynamic world environment, surrounded by rivals in unknown corners, there is no future in complacency and stagnation. You must press forward on all three fronts: spread your cities out to claim a significant share of the world, increase the size and production of each city, and strive to acquire the latest technology.

Your civilization cannot afford to lag too far behind your rivals in any one of these three spheres. A sufficient number of powerful cities can maintain the quantity of your military in any arms race. Keeping abreast of technology assures the quality.



The Hittites of antiquity had a brief moment of glory because the technology of their weapons was superior to that of their neighbors. But those neighbors had much larger populations, and when they acquired the same new technology, the Hittites were ushered off the world's stage.

Cortez landed at the Aztec city of Vera Cruz with only a few hundred conquistadors, but with the aid of superior weapons and diplomacy, he soon had Montezuma crying in his chocolate. The Aztecs were deposed before they could learn the technology of the Spanish.

Do what you can to keep your civilization growing in every area. More and larger cities, better technology, and better armies mean survival. Each city must be planned, managed, and protected so that it contributes to the power and glory of your civilization.

By maintaining this pattern of growth over the years, you have the best chance of avoiding the fate of the Hittites and Montezuma.

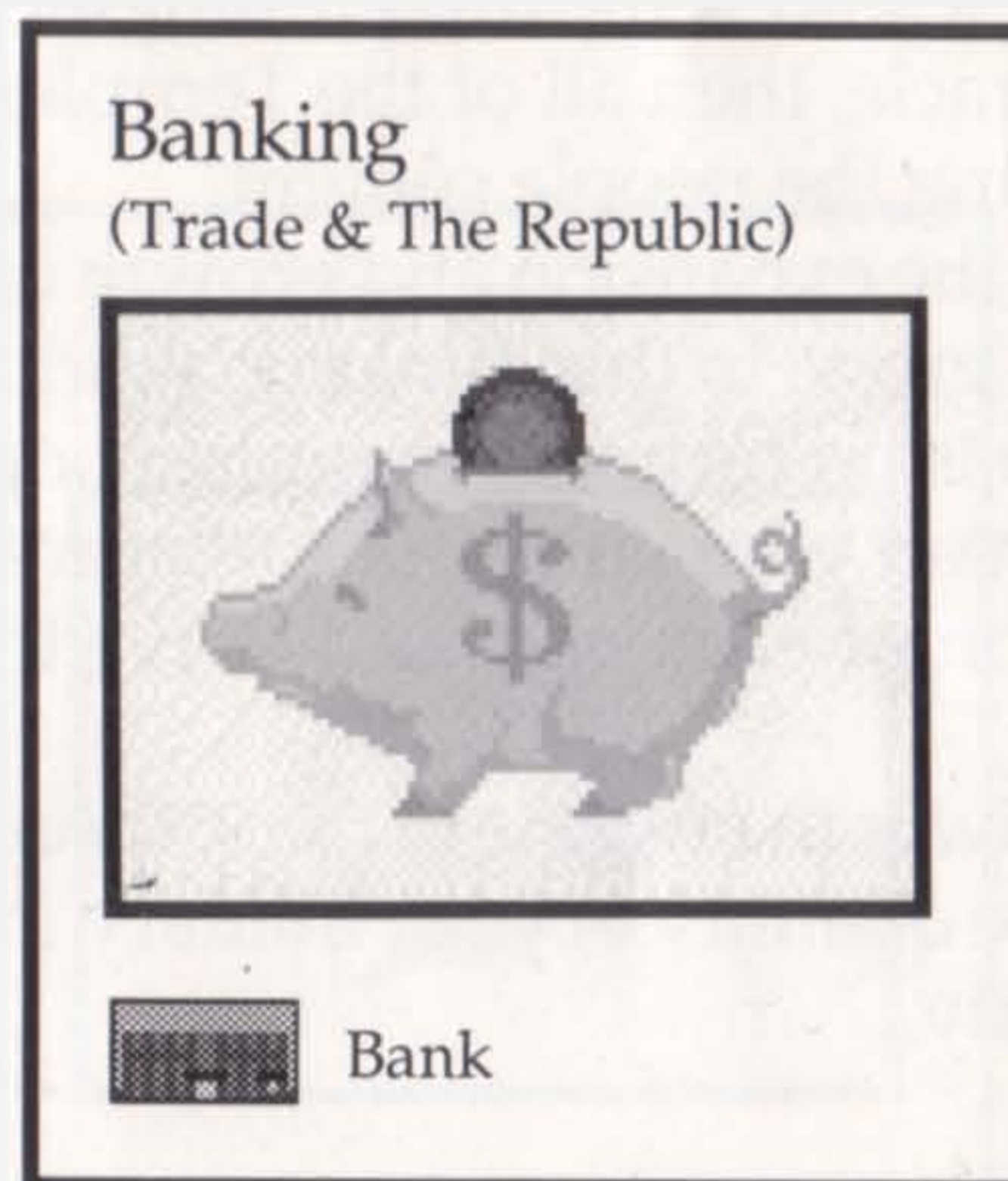

BEFORE YOU START

Sorting the Materials

This manual provides detailed instructions on how to play and gives information on the background of the topic. It applies to all computer systems, but specific references are given for use with an IBM system, for which the game was first designed. Interface controls generally assume that the IBM user has a mouse. A keyboard-only IBM interface is discussed in the IBM Technical Supplement.

The Technical Supplement gives specific instructions for loading and/or installing the game for your computer. It also provides a reference of keys used in the game specific for each computer system.

Installation

The Technical Supplement has complete information about how to install *Civilization* on either floppy or hard disks.

Learning the Game

Study Method: You can study the actual controls and instructions in this manual (pages 7-88) and in the Technical Supplement. Now begin play and refer back to the instructions as needed.

Jump Right In Method: This is the most popular with experienced computer game players. We recommend you at least read through Chapter One: Introduction, especially the sections Cities and Civilizations, Interface Introduction, and Ending the Game and Winning, but even this is not necessary. Refer to the manual's instructions for help with problems that arise.

Bridge Building
(Construction &
Iron Working)

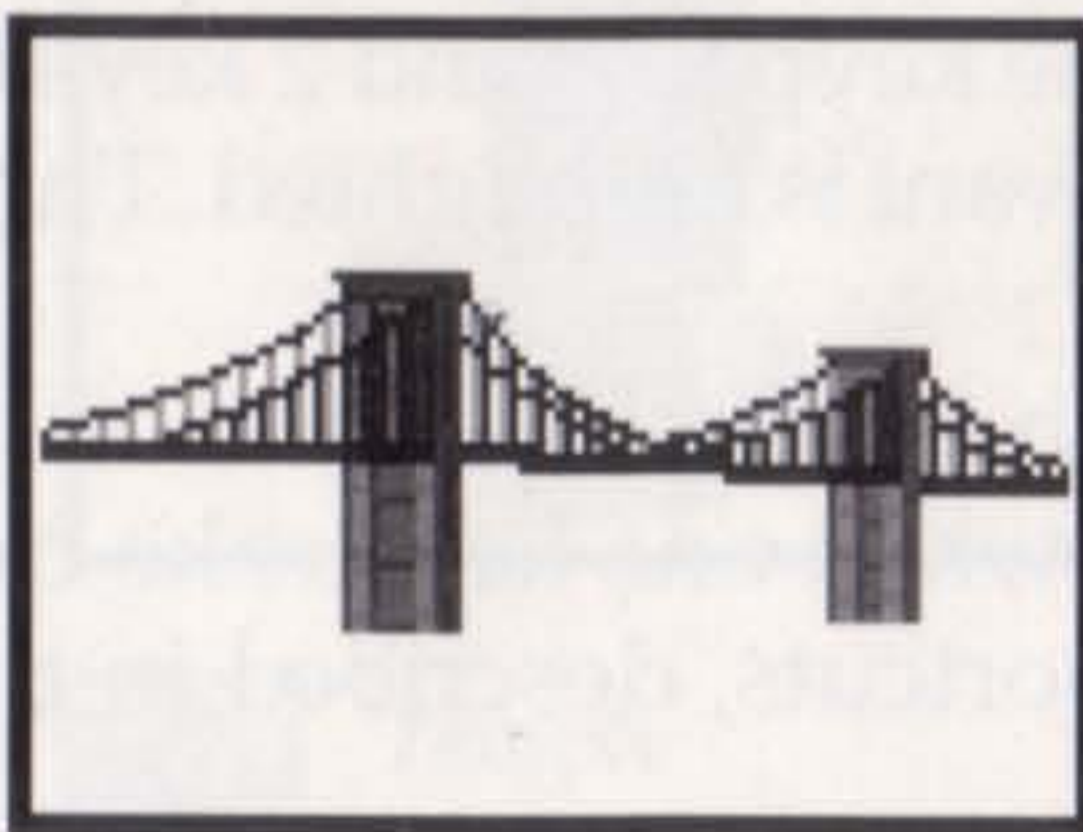

INTERFACE INTRODUCTION

Because *Civilization* was developed on an IBM system, the following discussion of the interface pertains to that version. Refer to the Technical Supplement in other versions for a description of the interface specific for those computer systems.

The interface of *Civilization* is designed to take advantage of the mouse. It may be played with a keyboard-only interface, but play is faster if you have a mouse available. (The IBM keyboard-only interface is discussed in the Technical Supplement.)

The interface operates mainly through two main game displays, the map display and the city display. Each of these displays is described in detail in its own manual section. Across the top of the map display is a menu bar. From the menus available here you can reach additional game functions and information not available from the displays.

The interface relies heavily on menus that are all used in a similar manner. Labeled buttons are also used in several places to perform a game function or reach further information.

Using the Mouse: To click the mouse on some part of the game, move the torch that is the pointer onto the desired location and click the correct mouse button.

The IBM mouse has two buttons and the interface makes a distinction between them. The left mouse button (LMB) is used to perform actions such as scrolling the map or activating a unit.

Opening Menus: Throughout the manual you are instructed to pull down menus to open them up and reveal the options they contain. To open a menu using the mouse, place the mouse pointer on the name of the menu in the menu bar and press the LMB. If you click the button the menu opens and stays open. Alternatively, you can press and hold the button, and then drag the pointer down the list of menu options.

When playing with the keyboard-only interface a shortcut key can be used to open the menus of the menu bar. For a list of these shortcut keys, see the Technical Supplement.

Menu Choices: To choose a menu option, place the mouse pointer on your selection and click the LMB.

Alternatively, if you pull down a menu, the options are highlighted as you pass over them. When the option you wish is highlighted, let the mouse button go to make your selection.

From the keyboard, you can make menu selections by using the keypad 8 and 2 keys to move the highlight bar up and down the menu until the choice you want is highlighted. Then press the Return key to make your choice.

Pressing Buttons: To press any labeled button, click on it with the LMB.

Shortcut Keys: Even when using the mouse, there are places when one keystroke can save several steps. Included in the interface are several of these shortcuts, described in the Technical Supplement.

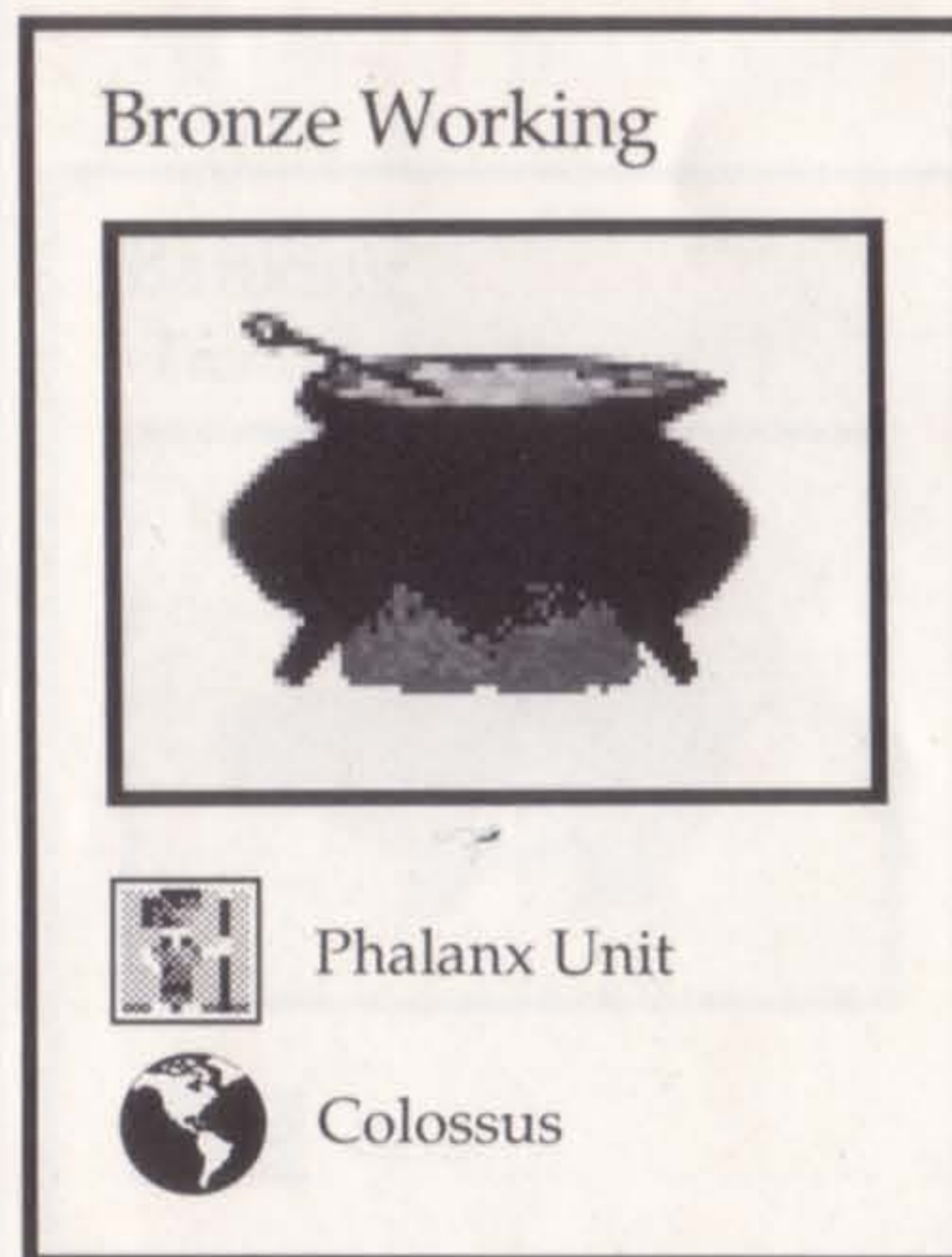

Map Interface

The map interface is explained in detail in the manual section, The Map Display, page 28. However, a few important commands are included here to help get started.

Map Scrolling: Click the LMB on any unoccupied map square to center it in the display. Click the LMB on any part of the world map in the world window to center the map display on that part of the world.

Current Unit: The unit on the map that is blinking is the current unit that is waiting for you to give it orders. It can be moved by using the keypad number keys corresponding the map direction you wish it to move.

City Display Interface

The city display interface is explained in detail in the manual section, The City Display, page 68. A few important commands are included below.

Opening/Closing City Display: Click the LMB on a city on the map to open its city display. Press the exit button to close the display and return to the map.

Production: Press the Change button above the production box to open a menu of items that can be built.

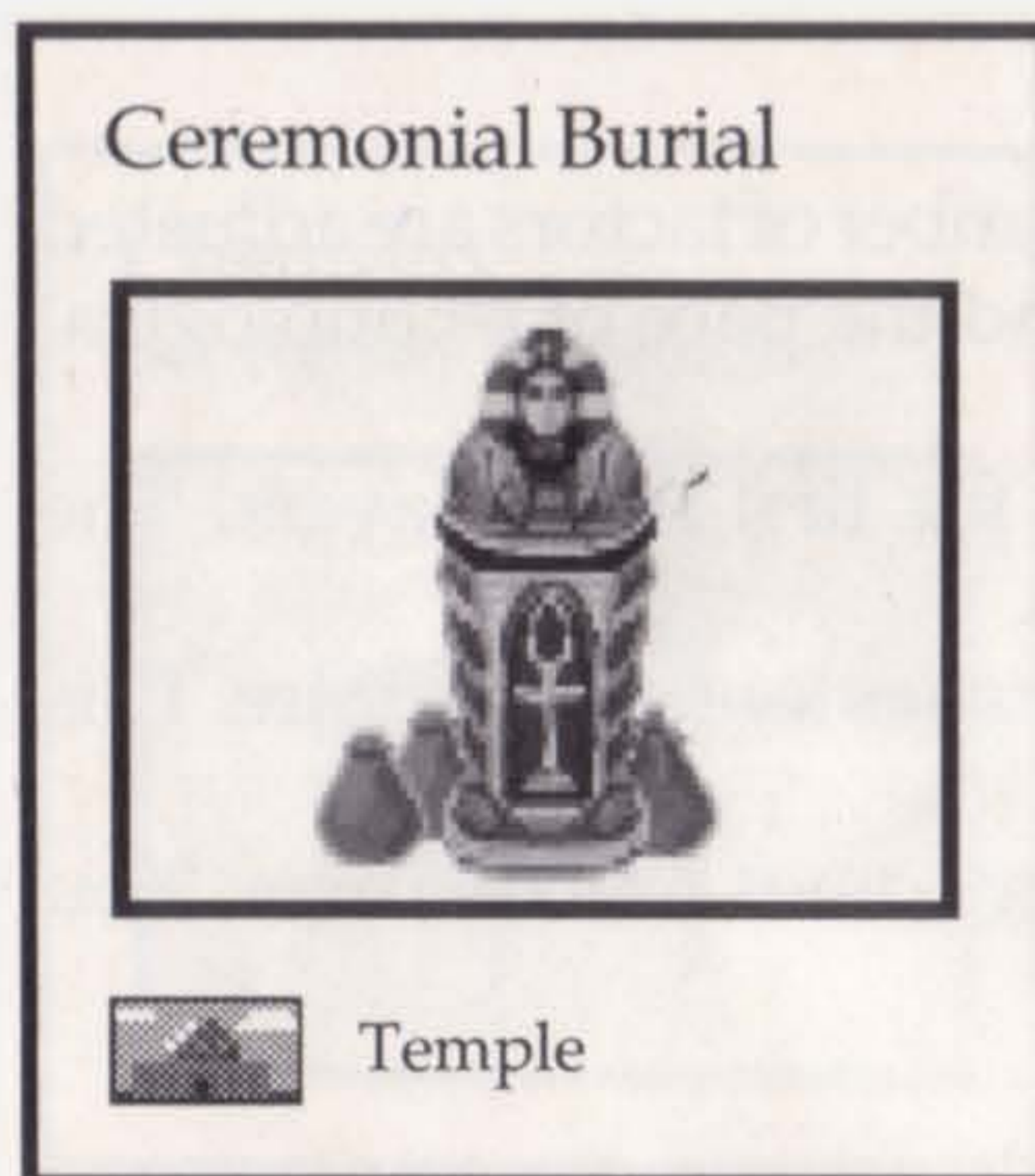

PRE-GAME OPTIONS

The beginning of *Civilization* requires you to make a number of choices regarding the parameters and world of the game you wish to play. To start, follow the instructions in the Technical Supplement for booting the game. After the title and credits appear, you proceed to the selection of the following pre-game options.

Game/World Options

The first menu that appears asks you to choose which game to load:

Start a New Game: If this option is chosen, a new game is begun on a newly generated world. This world resembles the Earth in land mass, climate, and rainfall. The new game begins in 4000 BC.

Load a Saved Game: Choose this option to load a previously saved game. As prompted, enter the letter of the drive where your saved games are located and press the Return key (for the IBM). When the list of saved games appears, select the game you wish to load. (For the IBM, use the keypad keys/Return key.)

EARTH: Choose this option to play on Earth. Your rivals are tribes placed in their historical locations.

Customize World: Choose this option to adjust your game world as you wish. From the menus that appear, choose an amount of land mass, average temperatures, amount of moisture, and starting date. The middle option of each menu is the default Earth-like world.

View Hall of Fame: Choose this option to open the Hall of Fame. For a description of the Hall of Fame, see page 23. After viewing the Hall of Fame you return to the Game/World Option menu.

Setting the Stage

When starting a new game, regardless of where, a presentation of the planet's history precedes the game start and is shown while the world is generated. You can clear the screen to skip this story (press the Return key or Spacebar on the IBM), but it may take some time anyway to generate the new world.

Difficulty Levels

Choose the level of difficulty at which you wish to play. A number of factors are adjusted at each level, including the time it takes to produce new units and the pace of technological advance.

Chieftain: This is the easiest level and is recommended for first-time players. The program provides advice when the player must make decisions.

Warlord: Your rivals are somewhat tougher and technology takes longer to acquire. This is for the occasional player who doesn't want too difficult a test.

Prince: Your rivals are substantially tougher and technology comes much slower. You will need some experience and skill to win at this level.

Level of Competition

King: Your rivals are most evenly matched with you in capability. Experienced and skilled players will play most of their games at this level as it is a strong challenge with victory far from foregone.

Emperor: This the most difficult level and only for those who feel the need to be humbled. This level can be won, but not consistently.

Choose between 3 and 7 civilizations in the world. More opponents is not necessarily more dangerous. The fewer your opponents, the more time you have to peaceably expand and develop before encountering rivals. More opponents means earlier contact and the risk of war. But contact with other civilizations offers the opportunities of trade, alliances, and the spoils of war.

Pick Your Tribe

Select your tribe from the menu of options. Where your first unit is placed on the map and the proximity of rivals is determined randomly except on Earth. In this case, the civilizations are chosen somewhat randomly but the ones chosen do start near their historic locale.

Your Name

Type in a suitably impressive name for yourself that contains no more than 14 letters. Enter the name into the game when you have finished typing it. (Press the Return key on the IBM.) The program will suggest a name that you can accept if you can't think of something better.

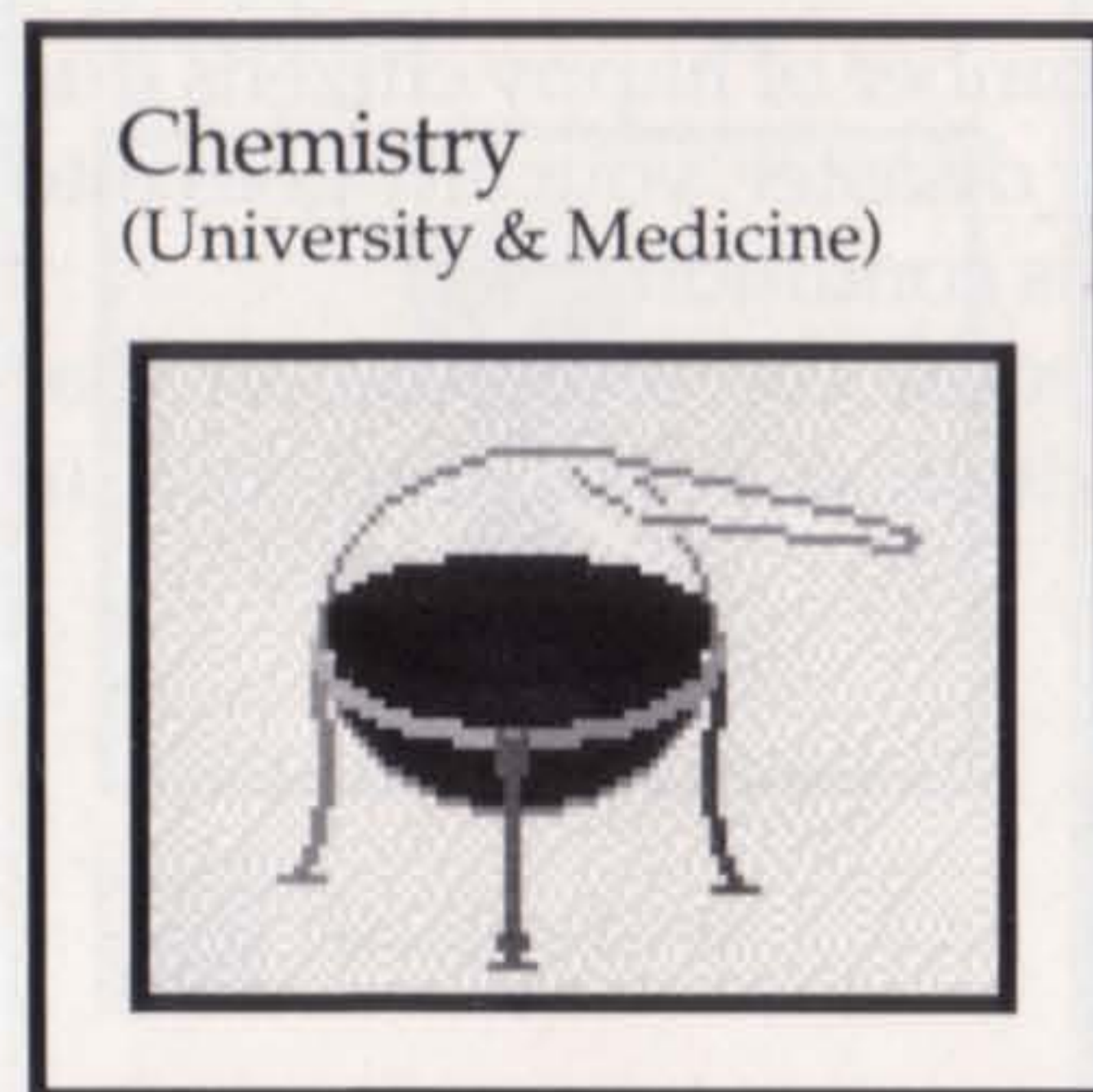

THE GAME TURN

Civilization is played in a series of turns, each following a sequence of play options. As each turn proceeds through the sequence, you direct the activities of your civilization, including the management of your cities, the production of new units, the building of city improvements, the movements and battles of your armies, and negotiations with other civilizations.

Each turn proceeds through the following sequence of play.

Date

A new turn begins with the advancing of the date. Depending on the current year, the date advances from twenty years to one year. The current date is found in the date window of the map display.

Disasters

At the beginning of a new turn there is a possibility of a natural disaster striking a city in the world. Any disaster that occurs is reported and takes effect immediately. Disasters can result in loss of population or the destruction of a city improvement. Most disasters can be prevented by a specific city improvement or technology. If the target city is prepared for the disaster, then the disaster does not occur. (See Disasters, page 88).

City Check

Each city in your civilization is checked individually for production, growth, unrest, maintenance, and scientific research. These concepts are explained in detail in the manual chapter Cities, page 61. All steps are carried out for one city before the next is checked.

Production: If the city produces sufficient surplus resources to complete the item the city is producing, that item is added to the city.

If your city does not produce sufficient resources to support all of the existing units for which it is the home city, units are destroyed until enough support is available. Units farthest away from the city are destroyed first.

Growth: If the city produces sufficient surplus food, it grows by one population point. This added population is put to work on the city map.

Disorder: If the number of unhappy citizens exceeds the number of happy citizens due to population growth or the destruction of a city improvement by disaster, your city goes into civil disorder (see page 66). You receive a message reporting this condition.

If this is the first turn of disorder, you jump to the affected city's display so that adjustments can be made to return the city to order. If the situation is not corrected, in following turns you are notified that disorder continues.

Movement And Combat

Maintenance: Taxes collected from the city are added to your treasury and then the maintenance costs for improvements in this city are deducted. If you don't have sufficient funds in your treasury to pay the maintenance costs, one improvement in this city, chosen by local leaders, is sold.

Note that while your civilization as a whole may have a revenue surplus for the turn, you can still lose an improvement when your treasury is low. High maintenance costs for the first cities checked may deplete the treasury and force a sale before later cities contribute their cash surpluses.

Scientific Research: The research contributed by this city, measured by the number of light bulbs it produces, is added to the total so far accumulated by your civilization. If this total is sufficient to acquire the technology that you have instructed your scientists to study, then you receive a message informing you that you have obtained this new technology.

After each city has been checked, you have the opportunity to move your active units. While a unit is moving it may engage in combat.

Each active unit is designated for movement, one after another. Each unit has the option of moving, not moving, or delaying its move until later in the turn. For more detailed information on moving your units, see Movement, page 33.

Combat occurs when a unit attempts to enter a map square occupied by a unit or city of another civilization (see Combat, page 35). (Exceptions: see Diplomats, page 37, and Caravans, page 39.) Normally, either the attacking unit or all defending units are destroyed when the combat is resolved. A victorious unit with movement points remaining may continue moving and even attack again.

During this movement phase you may pause to perform all other management tasks for your civilization. You may wish to consult with your advisors concerning the state of your civilization's trade, or science, or check the attitude of your population. You can examine any or all of your cities to adjust their work force placements or production. This is the time to change tax rates, governments, or examine the state of international affairs.

When all active units have been moved, your game turn is over and the next civilization moves.

Chivalry
(Horseback Riding &
Feudalism)



Knights Unit

End of Turn

Once all active units have been moved, your game turn may end. At this point a blinking "End of Turn" message appears in the unit identification window. So long as this message remains visible you may still examine cities, consult advisors, etc. To end your turn, follow the prompt to continue the game. (On the IBM, press the Return key.) Once you choose to continue, you cannot examine cities, etc., until the next turn.

The End of Turn message may be toggled on or off from the Game menu. Open this menu and choose "Options." One of the options on this menu is "End of Turn." There is check mark next to the option indicating that it is on and is to appear at the end of each turn. To turn off the message, choose the "End of Turn" option and the check mark disappears.

Even when the End of Turn message is turned off, it still appears during any turn in which you have no active units.

When the End of Turn message is off, you receive no warning that the turn is about to end. At the moment you move your last unit, your turn is over and the next civilization begins to move.

Adulation

After all of the civilizations have taken their turns, there is a brief pause while the record keepers and historians examine your accomplishments to date. The people of your civilization may reward the outstanding success of your policies by expanding and improving your palace. In addition, independent historians and chroniclers may report on where you or your civilization stands compared to your rivals.

Palace: As your population grows, the people spontaneously expand and improve your palace to reflect the glory that your rulership has achieved. When the total population of your civilization reaches certain milestones, you may increase the size or improve the quality of your palace.

Clear the screen (press Return, the Spacebar, or either mouse button for the IBM) after the people offer to improve your palace. When a picture of the current palace appears, select whether you want an existing part improved or a new part added. Click on a button below a part of the palace to improve it, or click on a button just off the edge of the palace to add to it.

From the available parts then displayed, select the one you wish to have built. Palaces can be built in three styles: classical, medieval, or Middle Eastern. A miniature rendition of your palace is shown in the palace window of the map display.

Historians: There are four historians who occasionally report on the progress of the civilizations in your world. These reports are an opportunity for you to judge how you are doing. The historians are Herodotus, Pliny, Gibbon, and Toynbee.

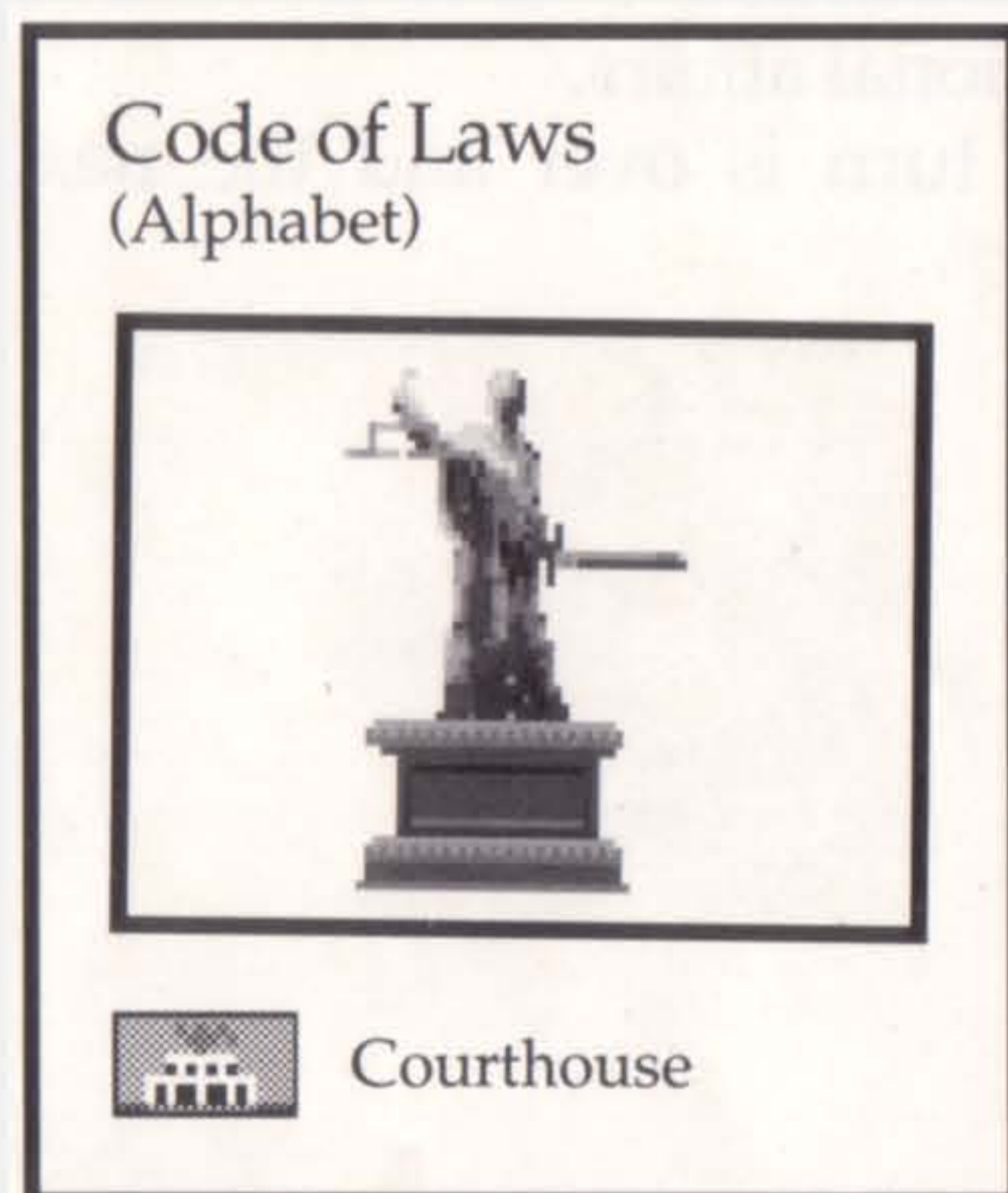

Civilizations may be judged in any one of five categories, listed below. The published list includes only the known civilizations, those with whom you have established an embassy. (Embassies are established by Diplomats, see page 37.) However, all civilizations, known and unknown, are considered in rankings. For example, if your civilization has the third highest population but the larger civilizations are not known, you would appear at the top of the list, but shown as number three in the world.

The five categories and how they are ranked follow.

Advancement: The number of technology advancements each civilization has acquired.

Happiness: The number of happy people in each civilization's cities.

Power: The total of the attack and defense factors of each civilization's military units.

Size: The population of each civilization.

Wealth: The size of each civilization's treasury.

Combustion
(Refining & Explosives)

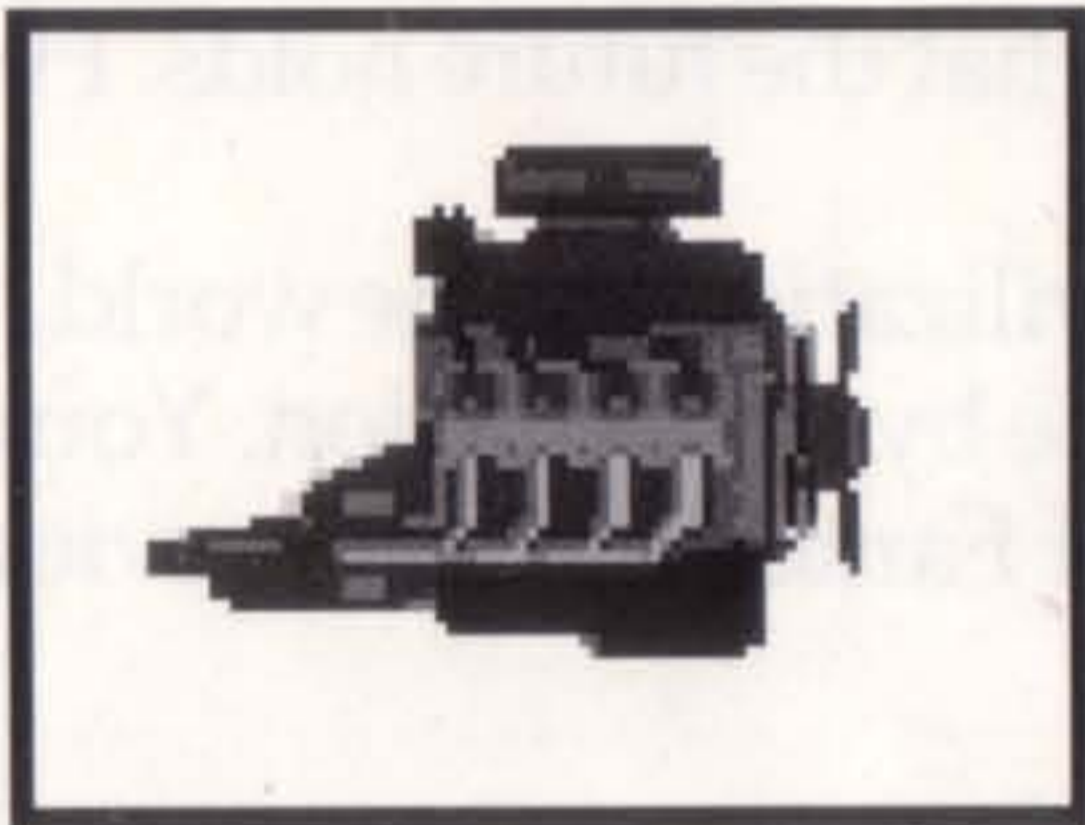

Cruiser Unit

ENDING THE GAME AND WINNING

Civilization may be ended in five ways. You may quit at any time, retire at any time, be destroyed by a rival, continue on until the game and the history of your civilization both automatically end, or conquer the world by eliminating all other civilizations. If you retire or let the game run its course the performance of your civilization is judged and compared against your peers. If you have been a good manager and leader, your name may be added to the *Civilization* Hall of Fame.

Although the game ends for scoring purposes after you win, you may continue playing if you choose. After winning, you are offered the opportunity to keep playing if you wish to see what more you can accomplish. No additional score is kept for this extra play.

Ending Play

Quitting: You may quit during your civilization's turn by pressing the Quit key (Alt + Q on the IBM). You must be at the map display and one of your units must be waiting for orders (blinking on the map). You may not quit when another civilization is taking its turn or from any other display. When you quit, you are given one chance to change your mind before the decision is irrevocable. You are not shown your civilization score or entered into the Hall of Fame.

Retiring: To retire, open the Game menu and choose the option "Retire." You are given one chance to change your mind. If you proceed to retire, you are shown your civilization score and entered into the Hall of Fame if you qualify.

Destruction: If your civilization is destroyed by one of your rivals, then the game automatically ends. You are not given a chance to start over in this world. Since you can have no score, you can not qualify for the Hall of Fame. You may review a replay of the world's history. If you want to play again, you must start over with a new world.

Automatic Ending: A game of *Civilization* ends when a spaceship containing colonists from any civilization reaches the nearby Alpha Centauri star system. All play temporarily ceases. Your final civilization score is reported and you are entered into the Hall of Fame if you qualify. However, you do not necessarily have to quit playing. Although your score is not recorded hereafter, if you wish, you may continue playing to see what the future holds. From this point on you must quit to stop playing.

Conquer the World: If you succeed in eliminating all other civilizations in the world, the game automatically ends. This is the ultimate achievement possible by a civilization. You are shown your civilization score and may be entered into the Hall of Fame. You may review a replay of the world's history.

Communism
(Philosophy &
Industrialization)



United Nations

Winning

You win a game of *Civilization* in either of two ways: by eliminating all rival civilizations or by surviving until the colonization of space begins.

The elimination of all other civilizations in the world is very hard to accomplish. You are much more likely to win by being in existence when colonists reach Alpha Centauri. Even if the colonists are not yours, the successful direction of your civilization through the centuries is an achievement. You have survived countless wars, the pollution of the industrial age, and the risks of nuclear weapons.

When the game is won by either method, your skill as ruler is measured by a final civilization score.

Civilization Score: This is the sum of the following factors, plus any bonus for space colonists or conquering the world.

2 points: each happy citizen

1 point: each content citizen

20 points: each Wonder of the World

3 points: each turn of peace (no war anywhere)

10 points: each futuristic advance your civilization acquires (see page 48)

(-) 10 points: each map square currently polluted

Space Colonists Bonus: In addition to the above points, if your spaceship is the first to reach Alpha Centauri you can receive a bonus score. This is 50 points per 10,000 colonists sent, multiplied by the success percentage of your mission. For example, if your spaceship arrives first with 10,000 colonists and the success percentage of your expedition was 80%, then you receive 40 bonus points.

Conquering the World Bonus: If you succeed in conquering the world, you receive up to 1000 civilization points, plus a bonus for the date. The faster you conquer the world, the higher the bonus.

The Hall of Fame

The Hall of Fame records the best five civilizations that you have built, listed in order of their civilization ranking. This ranking is determined from the basic civilization score multiplied by a difficulty factor and a competition factor. The higher the civilization ranking, the higher the position in the Hall of Fame.

You can examine the Hall of Fame when starting a new game from the pre-game options menu. When you retire or reach the automatic end of a game, you go to the Hall of Fame, even if you don't qualify to enter.

While at the Hall of Fame you may clear all of the current entries if you wish. (On the IBM, click the LMB on the Clear button.)



2. THE WORLD

THE WORLD MAP

The world surrounding your civilization is an entire planet consisting of several continents, islands, and ocean. A totally new planet can be generated each game or your civilization can attempt to prosper on the historical Earth itself. All planets are bordered by impenetrable polar caps to the north and south, but are not bounded east and west. Moving off the east edge brings you back onto the west edge.

As mentioned in the section on Pre-Game Options, new worlds are Earth-like in terms of temperature, moisture, and land mass. These factors can be adjusted if you wish to experiment with different combinations.

You begin with almost no knowledge of the world. The wandering tribe that is the ancestor of your civilization (represented by one or more Settler units) has explored only that part of the world that it occupies or can see nearby. The rest of the world and the other civilizations putting down their roots are hidden, over the mountains, through the forests, and across the seas. As your units move and explore, they discover more of the world's geography, important resource sites, other minor tribes, and, eventually, the evidence of rival civilizations.

World Geography

The world is divided into small independent parts known as squares. Each square consists of a unique type of terrain. Each type of terrain has its own economic usefulness, effect on movement, and effect on combat. Detailed information about the terrain types is also available from the Terrain Chart in the Technical Supplement or in the Civilopedia.

The economic usefulness of the various terrains is important when selecting city sites. The terrain that is close to a city produces the food, resources, and trade the city needs to grow and be productive. Some terrain types are more valuable than others. Some may be irrigated or mined for increased economic value, and others may be converted into another type of terrain (see Settlers, page 37).

When selecting sites for new cities, consider the terrain types that are within the radius of the prospective city (see The City Radius, page 62). The best city sites offer immediate food, resource, and trade production, plus the potential for long term development.

A brief description of the terrain types follows.

Arctic: Frozen glaciers of ice and snow found near the north and south poles. No food, resources, or trade can be obtained here.

Desert: Very dry region that can be developed to be marginally productive. There are some resources present that can be mined, food can be produced if the desert is irrigated, and roads generate some trade.

Grassland: These open lands have especially thick topsoils making them excellent food producing areas. Food production can be increased by irrigation. Roughly half of the Grasslands also have some resources, making them excellent city sites. Grasslands may be converted into Forests for increased resource production.

Hills: An area of rolling hills that offers easy access to minerals, sources of water, pastures, and some possibility for agriculture. When mined, Hills produce excellent resources. They also produce some food and can be irrigated if necessary. Irrigating Hills allows the irrigation to pass on to further squares that may be otherwise cut off from water.

Jungle: These areas of rain forest and dense jungle produce relatively poor amounts of food and no resources. However, they can be made much more valuable by conversion into either Grasslands or Forest. For this reason, the long-term potential of a city site containing several Jungles is good.

Mountains: This very rugged terrain can only produce a small amount of resources but this can be increased by mining. Mountains make the best defensive terrain, but the production is so low that they make a poor economic choice for the site of a city.

Ocean: Oceans produce small amounts of food, but a substantial trade. Only ships or aircraft can enter Oceans. Landlocked Oceans are really lakes but are treated like other Oceans in all respects.

Plains: These open areas differ from Grasslands in having poorer soil but better resources of timber and minerals. They are poor food producers unless irrigated. Due to the presence of resources, they make good choices for city sites. Plains may be converted into Forests.

Rivers: Rivers are great sites for starting cities and civilizations due to the richness of riverbank soils and natural trade routes for boats. Rivers are as good as Grasslands for producing food and always generate trade. River terrain may be irrigated to increase food production. It was no accident that the first civilizations sprang up along rivers.

Swamp: These coastal wetlands and flooded interior lands produce only a small quantity of food. Like Jungles, however, they can be converted into Grasslands or Forest.

Tundra: These sparse lands of permafrost produce only a small amount of food from grazing animals. There is no agriculture or use for irrigation. These areas cannot be converted to other terrain and make very poor city sites.

Forest: These woodlands produce a modest mixture of food and resources. If more food production is needed in the area, they can be converted into Plains.

Computers (Mathematics & Electronics)

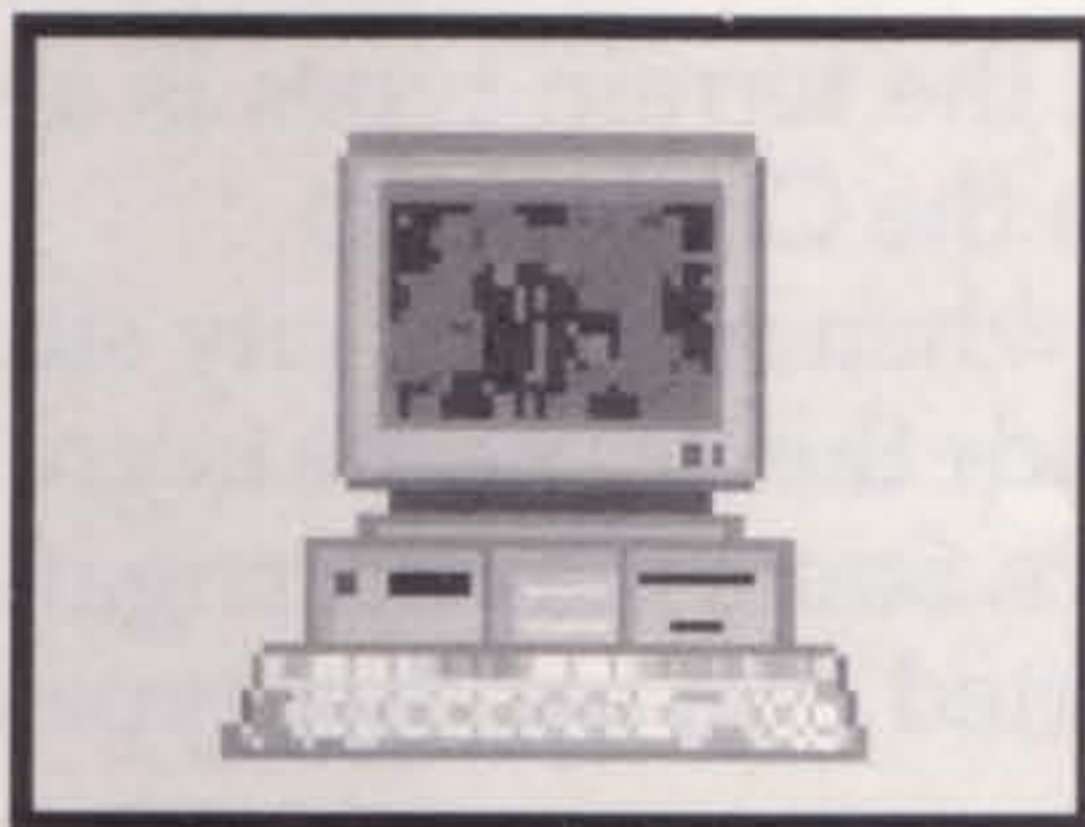

SETI Program

Special Resources

Special resources can occur in many terrains and add significantly to their economic value. The location of these resources is marked by distinct symbols that are uncovered as the map is explored. More detailed information about special resources can be found on the Terrain Chart in the Technical Supplement or under the entry for their base terrain in the Civilopedia. A brief description of the special resources follows.

Coal (Hills): Coal deposits represent rich locations of coal or metal ores. These areas produce greatly increased resources, especially when mined.

Fish (Ocean): Fish represent the location of underwater banks and reefs where currents and nutrients create excellent fishing grounds. Fishing banks produce increased amounts of food.

Game: (Forest and Tundra): The presence of game indicates excellent food sources available or the potential for good grazing. Game areas produce additional food, but cannot be improved.

Gems (Jungle): Gems indicate the presence of precious stones, ivory, spices, salt, or other valuable commodities. These are good trade items and therefore generate substantial trade from the area.

Gold (Mountain): Gold represents a bonanza of gold or silver. The value of these deposits produces tremendous trade.

Horses (Plains): Horses represent an increase in resources from this area due to the benefits of using domesticated animals such as the horse or oxen to do work. For all but the most recent periods of history, animals were an important source of lifting and pulling power.

Oasis (Desert): The oasis is a very fertile island in the desert that takes advantage of the presence of some water and rich local nutrients. The result is an area that produces substantial quantities of food.

Oil (Swamp): Oil represents the presence of mineral wealth, especially petroleum. The result is a substantial quantity of resources. Oil resources cannot be improved by mining.

Note: If you convert terrain containing a special resource into another terrain type, the original special resource is lost. In some cases a special resource that can be found in the new terrain may appear.

During exploration, minor tribes may also be discovered in the world. These are small tribes that have not yet advanced to be civilizations. If you enter a minor tribe's village by moving onto it, a number of things may happen. You may discover valuable metals, the tribe may become a mercenary unit in your army, you may discover a scroll of ancient wisdom that advances your civilization, your magnificence may inspire them to become civilized and found a new city in your empire, or they may prove to be extremely violent barbarians.

Minor Tribes

Minor Tribe Icon

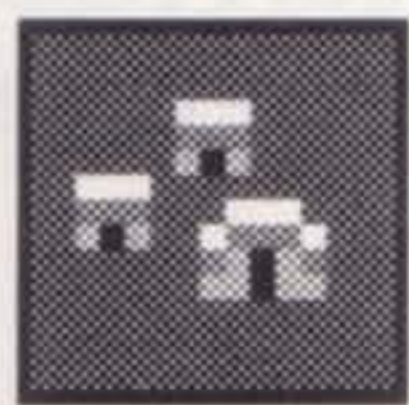

THE MAP DISPLAY

This is the display most commonly used during play. From here you control the movement and combat of units throughout the world, monitor the moves and development of other civilizations, and summon the reports of advisors. From the map display you can examine the known geography of any part of your empire or those of your rivals. The map display consists of six parts: the map window, the world window, the menu bar, the palace window, the status report, and the unit identification window.

Map Window

The large map window in the display shows one part of the world map in detail. Here you can examine the terrain, control the movements of units, scout sites for new cities, and prepare war plans.

When your civilization is just getting started, most of the world is unknown. The map is covered and hidden from view. As your units move and explore, the hidden areas are discovered and the map fills in. It is useful to uncover the world quickly to find good areas for expansion, absorb any minor tribes nearby, locate opposing civilizations, and determine likely avenues of approach by enemies.

There are a number ways to quickly change maps and otherwise look at different parts of the world. These are described below. (Interface controls are explained for using a mouse with an IBM system.)

Change Maps: You can quickly scroll around the world changing the map visible in the map display. (On the IBM, click the LMB on any visible map square and the map scrolls, centering on the square you selected.) See the section World Window below for another way to quickly change maps.

Center on Unit: You can center the map on the unit now waiting for orders (blinking), regardless of where it is in the world. If the waiting unit is not visible, the map scrolls so that the unit appears centered. Press the Center key. (On the IBM, press the C key.)

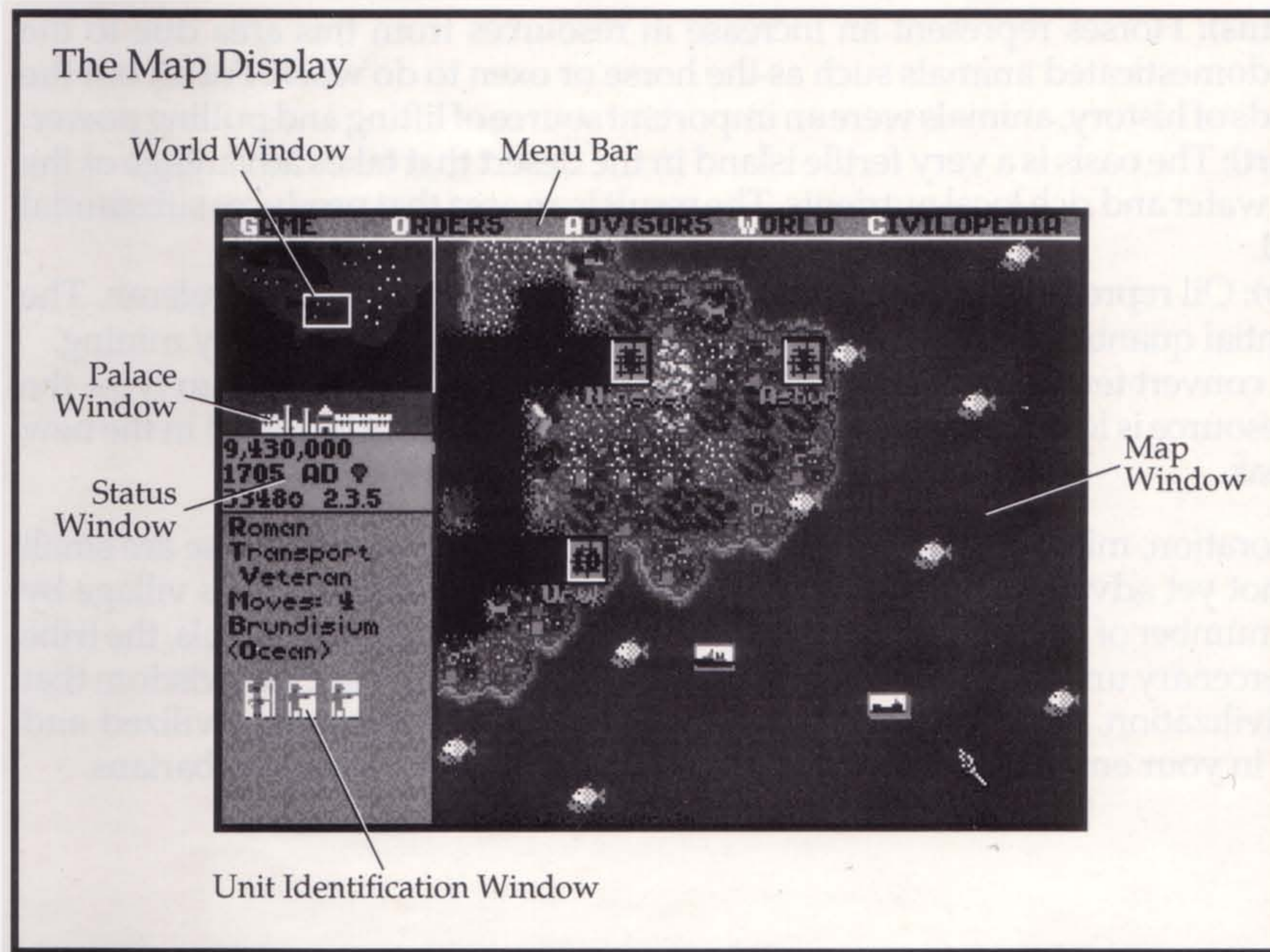

World Window

Find City: You can center the map on any known city in the world. Pull down the Game menu from the menu bar and choose the option "Find City." Type in the name of the city and press Return (on the IBM). The map scrolls and centers on the city. If you have not yet discovered the location of a city, nothing happens if you try to find it using this method.

Note that you need not type in the entire name of the city, just enough letters to distinguish it from any other city in the world.

This window in the top left of the display shows a map of the entire world. It is centered on the part of the world currently shown in the map window. A box is positioned on this world map (colored white on the IBM) to show what part is now visible in the map window.

In the early days of your civilization, while most of the map is still unknown, the world window is of little help in showing where you are located in relation to other islands and continents. Because this window centers on the map display, if most of the world is hidden you cannot know where the polar caps are or even what hemisphere you occupy. You may be quite near one of the polar caps but not know it. After some exploration, you can better judge your location and that of your rivals.

Map Scrolling: You can use the world window to speed the scrolling of the map display. (On the IBM, place the mouse pointer in the world window on the part of the world that you wish to center in the map window and click the LMB. The world window shifts and the map window scrolls to center on the position you pointed to.)

Menu Bar

The menu bar is found across the top of the map display. From here orders may be passed to units and various reports from advisors may be summoned. There are five menus available: Game, Orders, Advisors, World, and Civilopedia.

The Orders menu lists any special commands that can be given to the unit waiting for orders, in addition to normal movement commands. Refer to the manual section Additional Orders, page 36, for a description of the commands possible.

The Advisors and World menus contain special reports that can be requested from your various advisors. Refer to the manual section Advisors/World Reports, page 46, for a description of these reports.

The Civilopedia menu gives access to the on-line encyclopedia of *Civilization*. Use this to quickly obtain information on many different topics such as technology advances, military units, terrain, etc. See the manual section Civilopedia, page 51, for a description of the information available.

The options available from the Game menu are the following.

Revolution!: In order to change your civilization's type of government, you must have a revolution. The government goes into Anarchy for a period of turns and a new type of government may be chosen. You must have acquired specific technologies to choose a type of government other than Despotism. For a detailed explanation of this option, see the manual section Governments, page 43.

Tax Rate: The trade that cities generate arrives as luxury goods, tax revenue, and new ideas (technology research). Here you can change the percentage that becomes tax revenue. See Trade Rates below for more information.

Luxury Rate: Change the percentage of trade brought in as luxury goods. See Trade Rates below for more information.

Find City: Choose this option to locate a city in the world. Type in the name of the city you wish to find. The map window centers on the city.

Options: Choose this menu option to turn on or off some game features. Features available are Instant Advice, Autosave, End of Turn, and Animations. A check mark next to the feature indicates that it is on. Choosing an option that is on turns it off and vice versa.

Instant Advice provides some helpful hints for new players. The *Autosave* feature automatically saves your game every 50 turns. When *End of Turn* is on, a message reports the end of each turn and must be cleared for the game to continue. If you have no active units, this message appears whether toggled on or off. *Animations* may be on or off.

Save Game: Choosing this option stops play to save your game. (On the IBM, follow the prompts for entering the drive where you wish the game to be saved.)

Retire: Ends the history of the civilization you now rule, calculating your score. If the score is high enough, you may enter the Hall of Fame. Note that your civilization is lost if not saved first.

Quit: Ends the history of the civilization you rule. No score is calculated and your civilization is lost if not saved first.

This window presents a miniature rendition of your palace. Its breadth and grandeur is a depiction of how well your civilization is progressing. If your civilization prospers and grows, the people recognize the glory of your rulership by periodically improving and expanding your palace. The relative magnificence or shoddiness of your palace is displayed for you, your advisors, and international emissaries to see.

For more information on the palace, see the section Palace, page 20.

Palace Window

The Status Report

The entries and symbols here report the current date and several facts concerning the status of your civilization.

Date: The date is reported in years plus the notation BC or AD. The normal game begins in 4000 BC. Each turn represents the passing of so many years, depending on the current date.

Treasury: The amount of cash in your treasury.

Population: The size of your civilization's population.

Trade Rates: The three numbers separated by periods are your trade rates. The first number is the percentage of your trade that provides luxuries. The second rate is the percentage that becomes tax revenue added to the treasury. The third rate is the percentage put towards new ideas to help learn new technology.

Luxury goods are the cultural pleasures like music, art, sports, and the theater that people come to enjoy when they have leisure time. The more luxuries that can be provided, the more happy citizens in your cities.

Tax revenue goes into the treasury and is needed to maintain existing city improvements. Excess taxes over maintenance needs accumulate in the treasury and can be spent later. Taxes, especially high ones, tend to make the people unhappy.

The more new ideas and scientific research accomplished, the faster new technology is acquired.

Each of the three by-products of trade has its benefits. As time passes and cities grow, you may have to adjust the trade rates often to provide a minimum amount of taxes and science

research while keeping the population content as a whole. To adjust trade rates, pull down the Game menu and choose either the Tax Rate or Luxury Rate option. By setting these two rates, the science rate is set by default.

New Ideas: This scientific research indicator, shaped like a light bulb, shows how near you are to making a civilization advance. The nearer you get, the more the light bulb fills in (yellow on the IBM). When the bulb is full (bright yellow), it is on, indicating that you have acquired a new technology. Once the new idea is reported and your scientists are sent off to study something else, the light bulb is turned off. As your scientists progress, it gradually turns on again. For more information on civilization advances, see Science Advisor, page 48.

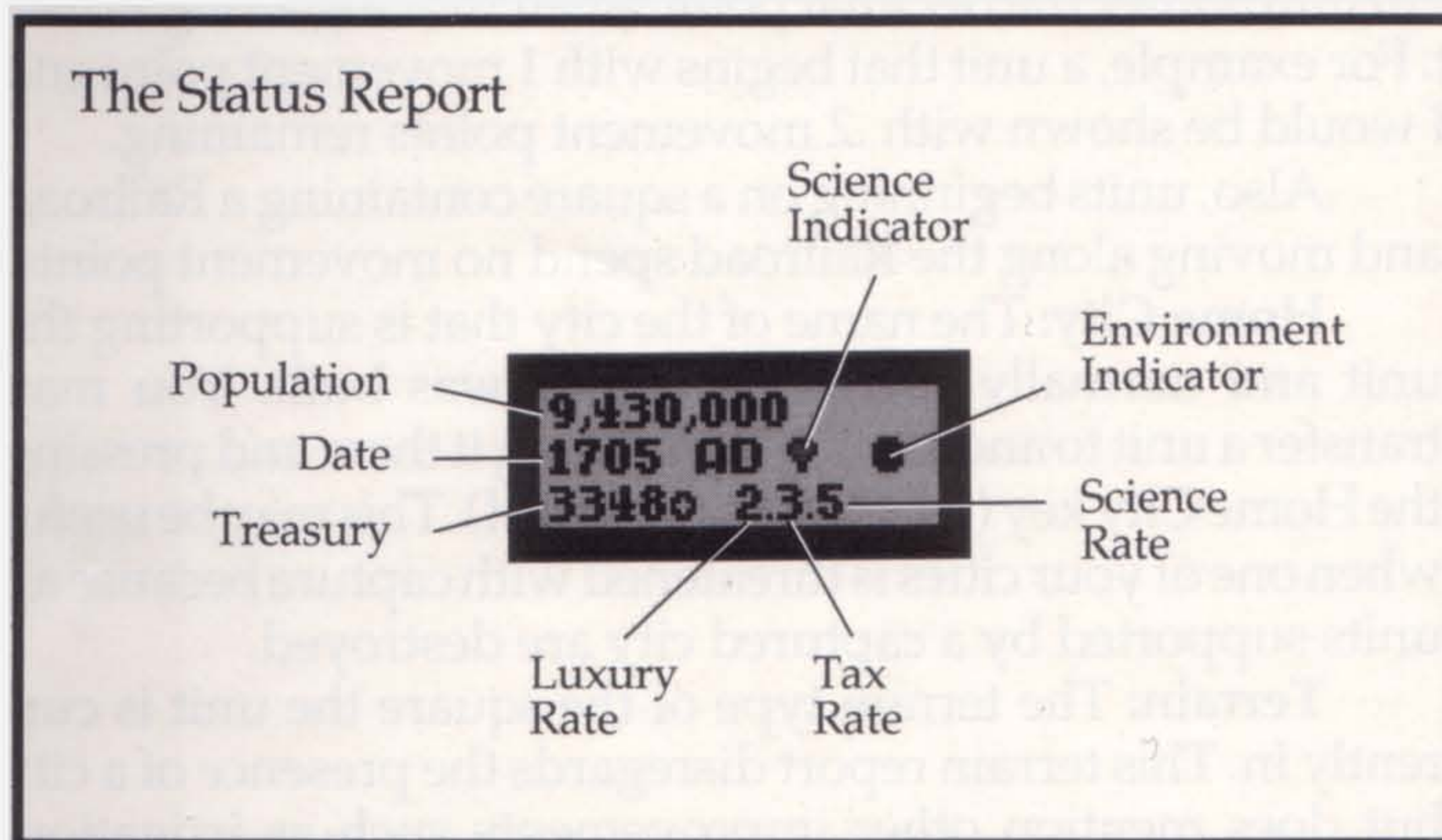

Environment: The environment indicator is the sun, and its color shows how great is the risk of global warming. When there is no risk of global warming, the sun indicator is not present. With the first case of pollution, the sun indicator appears (colored dark red on the IBM). If pollution continues, the color gradually changes (on the IBM to light red, yellow, and then white). If pollution is not brought under control when the indicator is brightest (white on the IBM), the planet suffers a bout of global warming and then the indicator reverts to a cooler color reflecting the new equilibrium.

Pollution and environmental problems can also be caused by nuclear reactor meltdowns and fallout from nuclear weapons. For more information on pollution and global warming, see the manual section Planetary Caretaking, page 52.

The Unit Identification Window

The information reported here refers to the unit currently waiting for orders. This is the unit blinking. If the unit is not visible, press the Center key to center the map so that it is. (On the IBM, press the C key.)

The following information is shown.

Nationality: The name of your civilization, the one to which the unit belongs.

Unit Type: The type of unit and whether it is a veteran or not.

Movement: The number of movement points the unit has remaining to use. If you are finished moving a unit that has movement left, press the Pass key (the Spacebar on the IBM) to skip to the next unit.

Note that points are shown in thirds after the decimal point when moving along Roads because Roads triple movement. For example, a unit that begins with 1 movement point and moves one square along a Road would be shown with .2 movement points remaining.

Also, units beginning on a square containing a Railroad and moving along the Railroad spend no movement points.

Home City: The name of the city that is supporting the unit and normally the city where it was built. You may transfer a unit to another city by moving it there and pressing the Home City key (the H key on the IBM). This may be useful when one of your cities is threatened with capture because all units supported by a captured city are destroyed.

Terrain: The terrain type of the square the unit is currently in. This terrain report disregards the presence of a city but does mention other improvements such as irrigation, roads, railroads, etc.

Other Units: At the bottom of this window are shown any friendly units that also occupy this square. Units within a heavy black border are fortified. Units that are faded out are on sentry duty.

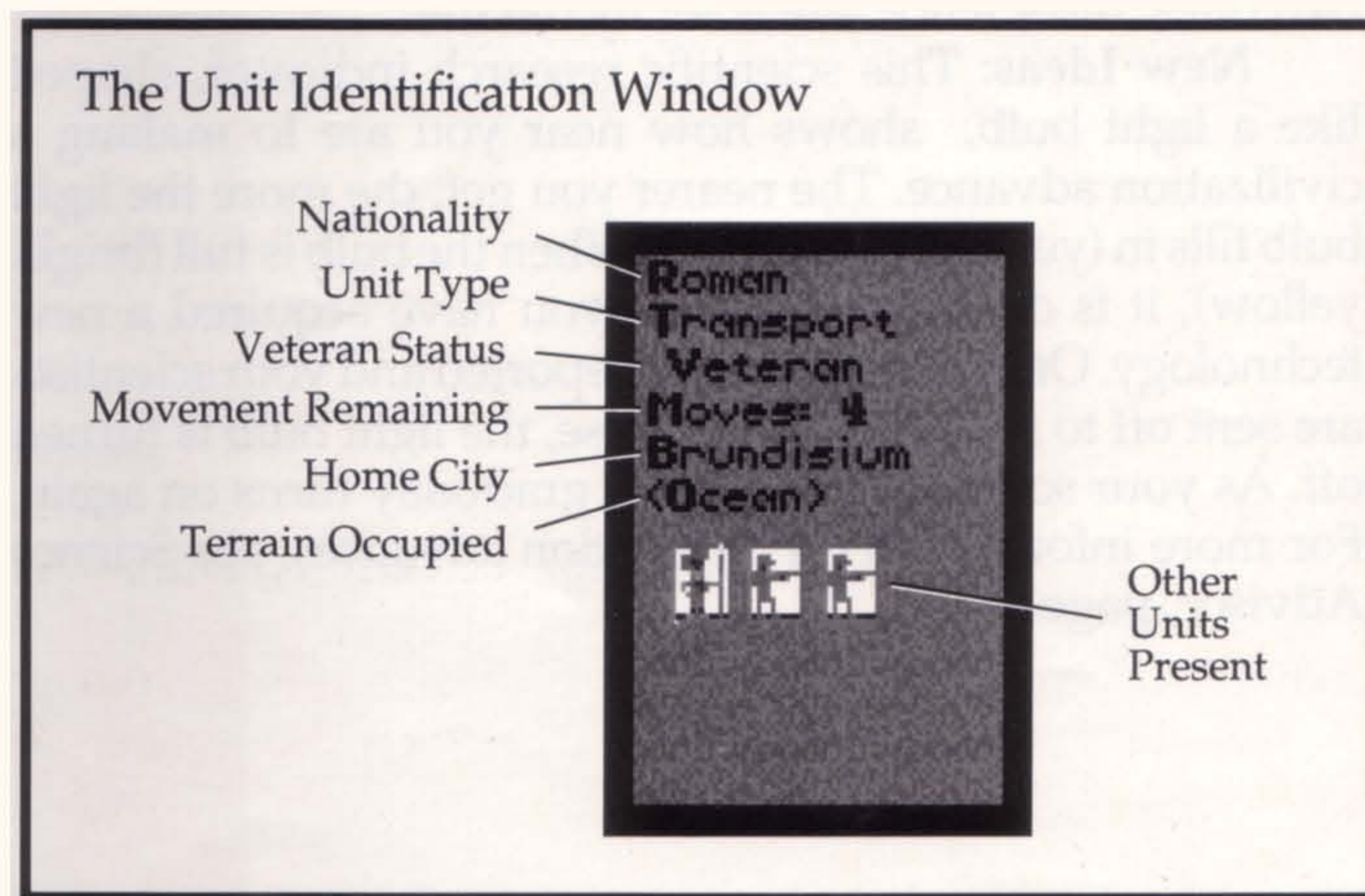

SETTLERS, SOLDIERS, AND ENVOYS

As ruler of your civilization you decide what military units to build, where to deploy them, and when to fight. In addition you control parties of Settlers looking to found new cities, Diplomats, and Caravans seeking to establish trade routes.

Through the years a majority of your time is spent moving and positioning armies. A strong military is required first for defense against rivals and barbarians. They are also the eyes of your civilization, exploring the world as they move. They can also serve you by defeating the armies of your rivals and conquering their cities.

Armies can be ground military units (Legions, Cannons, and Armor for example), naval units (Tribes, Ironclads, Battleships, etc.), or air units (Fighters and Bombers). Also available are four special units: Settlers, Diplomats, Caravans, and Nuclear units. All unit types available are described in the Civlopedia section Military Units.

After founding your first city, you may have the technology to build only two types of unit, Militia and Settlers. As your civilization acquires new technology, additional unit types become available for building. All new units that are built appear at the city where they are constructed and are available to be moved from that point.

All military units and Settlers have an *attack factor* (A), *defense factor* (D), and *movement factor* (M). The attack and defense factors indicate the army's relative strength when attacking and defending. The movement factor indicates how far the unit may move. In addition to moving and fighting, there are additional orders that a unit may be given.

Movement

Each turn, you may give orders to your units, one at a time. The unit waiting for orders blinks on the map. There are several order options available: move the unit across the map up to the limit of its movement factor, skip the unit if you prefer to move it later in the turn, or have it do nothing this turn.

In addition you may order most units to fortify or go on sentry duty. Fortified or sentry units no longer require orders. In future turns they carry on and do not blink, waiting for orders. If you wish to move these units later, they must be activated individually.

Moving Units: Units may be moved up to the limit of their movement factor. The cost to enter a map square depends on the terrain. Roads and Railroads speed the movement of ground units. When an unit is unable to complete a movement order because it doesn't have enough movement points to proceed, its movement is finished for the turn. The map then centers on the next unit waiting for orders.

(On the IBM, units are moved across the map by using numeric keypad keys 1-9, but not 5. Units may be moved in any of eight directions corresponding to these eight outside keys. For example, pressing the 2 key moves the unit one square towards the bottom of the map.)

Skipping Units: To skip a unit temporarily, press the Wait key (the W key on the IBM). This passes you on to other units waiting for orders and returns you to the skipped unit after all others have had a chance to move.

No Movement: To order a unit not to move, press the No Movement key (the Space Bar on the IBM). The map centers on the next unit needing orders.

Activating Units: Fortified units and those on sentry duty must be activated to receive movement orders. (On the IBM, place the mouse pointer on the square and click the left mouse button. This opens a menu displaying all units in the square. Click again on the icon of any unit you wish to activate.) Fortified or sentry units within a city must be activated from the city display- see page 76. Sentry units are also activated when enemy units move adjacent to them.

Movement Restrictions: Ground units (all non-ship, air, or nuclear units) normally move only on land. They may move over sea squares, but only by naval transport (see below). Ships may not enter squares entirely made up of land except cities that are on the coast. Air units may move over land and sea squares, but must land on a friendly city square or Aircraft Carrier unit to refuel.

Ground units may not move from one square adjacent to an enemy army or city directly to another such square. The prohibited square may be adjacent to the first enemy army, another army (even one from another civilization), or any enemy city. Ground units may move into such a controlled square if a friendly unit is already there. Air units, ship units, Diplomats and Caravans ignore these restrictions.

Naval Transport: Ground units may be carried over sea squares only by Triremes, Sails, Frigates, or Transports. Refer to the Civlopedia for specific information about these ship units.

Units may load onto a ship by moving onto it from an adjacent land square. Also, units on sentry duty in a city with a ship automatically load when the ship leaves. Units aboard ship are on sentry duty.

Units may unload when activated from sentry duty and adjacent to land. They can be activated by the normal method of activation or by pressing the Unload key when the transporting ship is blinking. (On the IBM, press the U key.)

Movement Restrictions Diagram

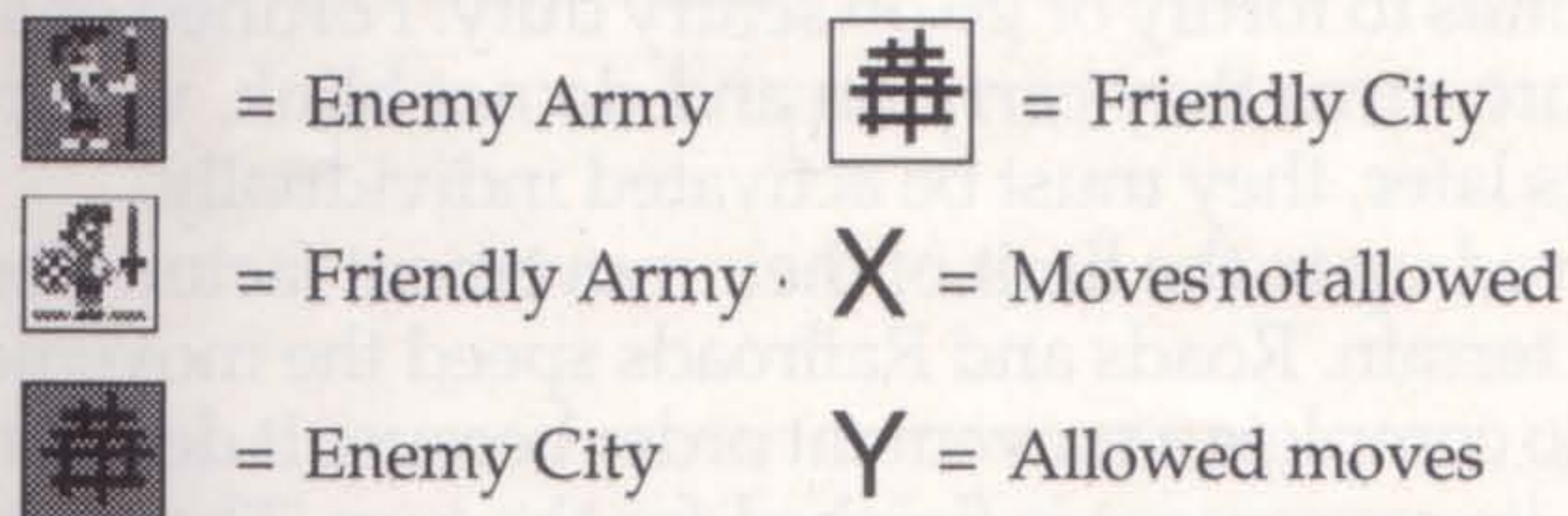
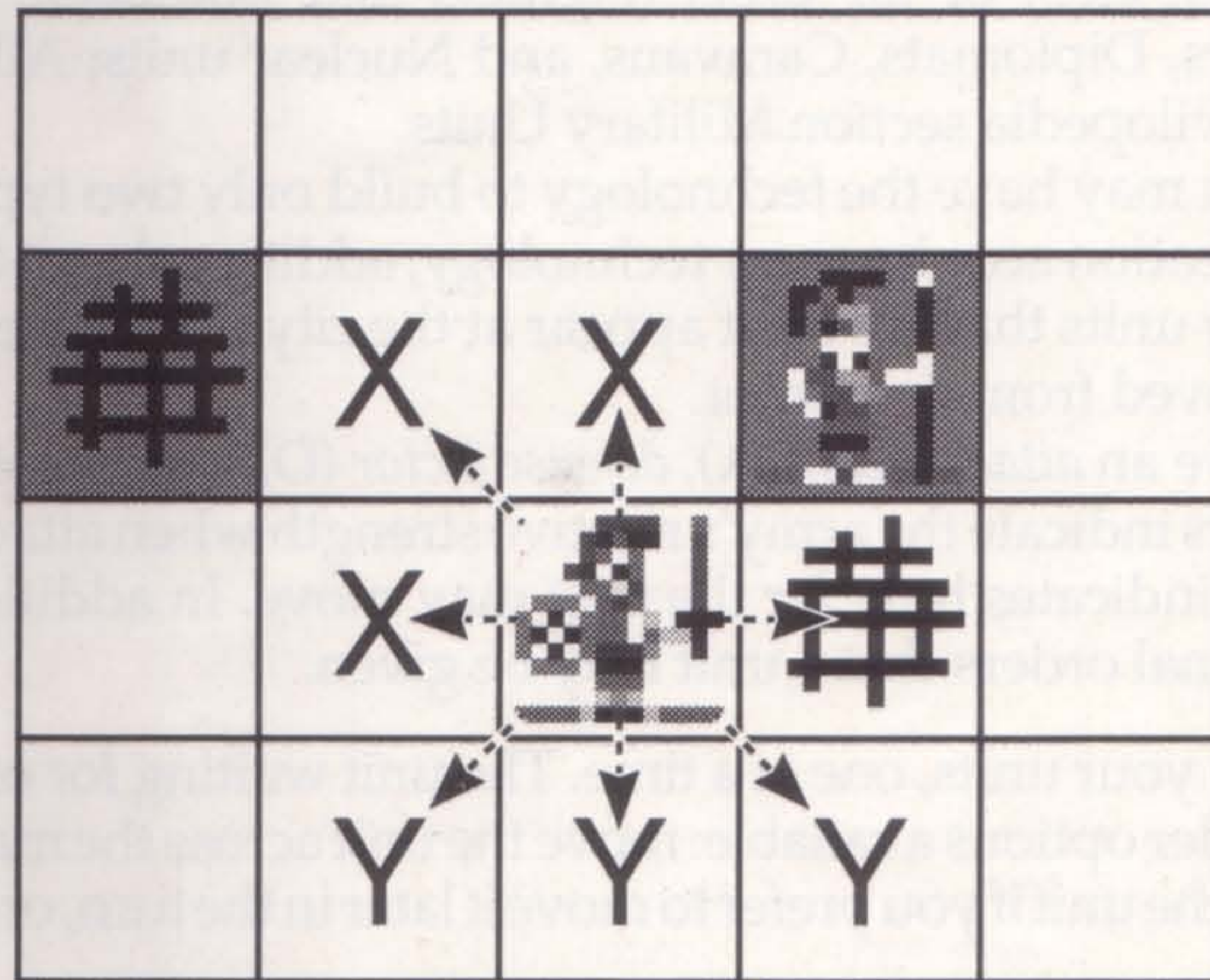

Notes:

1. **X** moves are okay if those squares already contain an army from your civilization.
2. Movement restrictions do not apply to ships, air units, diplomats, and caravans.

Combat

Combat occurs when a unit from one civilization attempts to enter a square occupied by a unit of another civilization. When this happens a battle is immediately resolved, resulting in the destruction of one army or the other. When more than one unit is in the defender's square, the unit with the highest defensive strength defends. If it loses, then all other armies stacked with it are destroyed as well. Successful attackers that have a full movement point remaining after combat advance into the defender's square.

The important factors in combat are the attack and defense strengths of the combatants, the presence of veterans, the terrain occupied by the defender, and any defensive improvements in the square. After all of these factors are considered, the combat is resolved as a simple calculation.

For example, if a Chariot (attack factor 4) attacks a Phalanx (defense factor 2), the Chariot has a 66% chance of winning (4 out of 6) and the Phalanx 33% (2 out of 6). If both units were veterans, the odds are 6 to 3. If both are veterans and the Phalanx was behind City Walls (which triples the defense factor), the odds are 6 to 9.

Shore bombardments, city attacks, nuclear attacks, and bribing enemy armies (see page 39 below) are special types of combat.

Attack Strength: The basic attack strength of all armies. This full strength is brought to bear so long as the army has at least one movement factor remaining from movement. Armies with less movement available may still attack but are penalized. Armies with high movement rates may make several attacks each turn at full strength.

Defense Strength: The basic defense strength of all armies.

Veteran Status: Veteran armies have their attack and defense strengths increased by 50% before any other modification. Armies become veterans when built at cities containing the Barracks improvement, or they may become veterans after winning a battle.

Terrain: Many of the world terrain types increase the strength of defenders. See the Terrain entries in the Civlopedia or the Terrain Chart in the Technical Supplement for details.

Fortified Armies: Ground armies may fortify themselves, increasing their defense strength by 50%. An army that has any movement points remaining may be ordered to fortify on any land square by pressing the Fortify key (the F key on the IBM).

Improvements: Armies within a Fortress have their strength doubled after all other modifications. Armies inside a city containing City Walls are tripled in strength. Cities protected by City Walls do not suffer population losses.

Attacking Cities: When a defender in a city is destroyed by ground attack, other defending units present are not destroyed. However, the population of the city is reduced by one point unless the city is protected by City Walls. Population loss does not occur due to naval or air attack, but is affected by nuclear attack.

Conscription
(The Republic & Explosives)

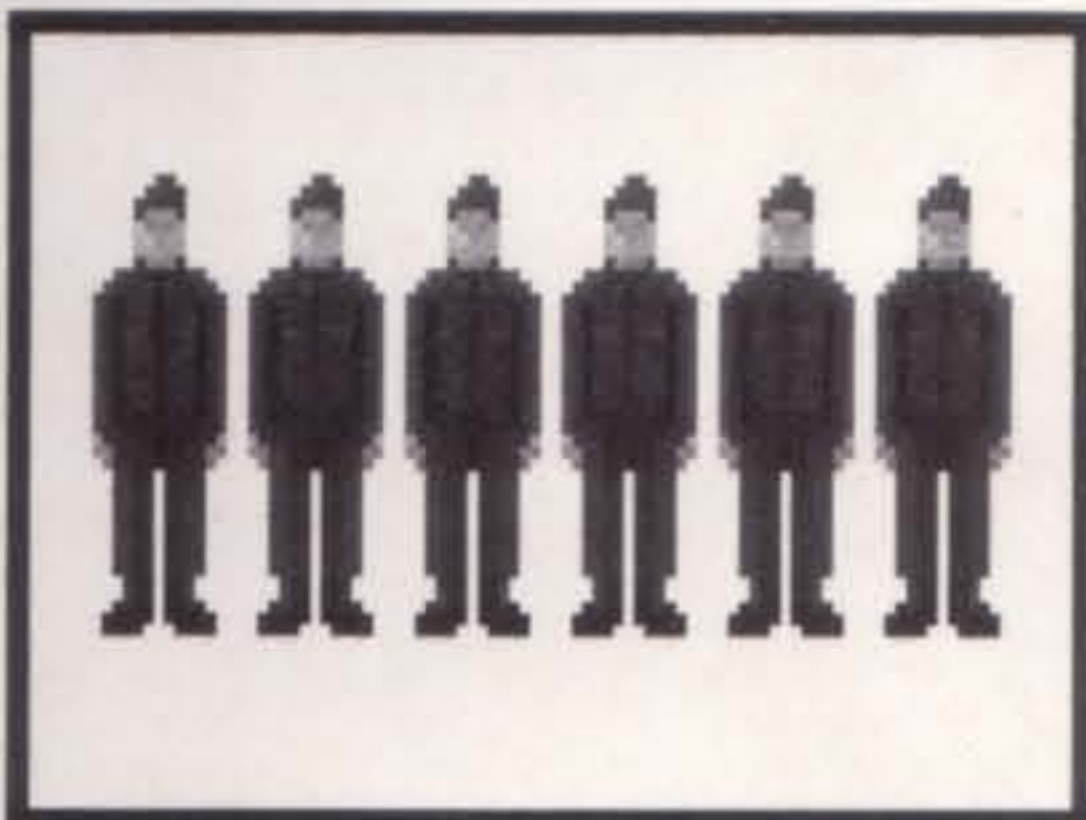

Riflemen Unit

Shore Bombardments: Naval units with attack factors, other than Submarines, may attack enemy armies on adjacent land squares, including cities. Naval units in cities may defend against attack.

Nuclear Attacks: Nuclear attacks occur when a Nuclear unit attempts to enter a square occupied by enemy units or an enemy city. In either case, all units, regardless of civilization, in the target square and adjacent squares are destroyed. In addition, a city loses half of its population. Nuclear attack can only be stopped by the presence of an SDI Defense improvement in a city.

Additional Orders

Units may be given a number of other orders besides movement (and combat caused by movement). Settlers and Diplomats may be given unique orders explained later.

Go To: Orders an army to proceed to a destination square as fast as it can. The army continues moving turn after turn until it arrives. Press the Go To key (the G key on the IBM), and then designate the destination square. (On the IBM, point to the square with the mouse pointer and press the LMB.)

Home City: Orders a unit to change its home city. Move the unit to the desired new home and press the Home key (the H key on the IBM). Air units in flight may use this key to move to the nearest friendly city. Press the Home key while the air unit is in flight and it immediately moves to the nearest friendly city or Aircraft Carrier. If the air unit does not have enough movement remaining to reach the nearest base, it crashes instead.

Sentry Duty: A unit on sentry duty is marked by a faded icon on the map. It no longer blinks each turn waiting for new orders. Sentry units are activated as explained above (see page 34). Sentry units automatically board any transporting ship that leaves a city they occupy. To put an army on sentry duty, press the Sentry key (the S key on the IBM).

Disband: This order disbands the unit receiving it, removing the unit from the map and city records. To disband a unit, press the Disband key (the Shift + D keys on the IBM).

Pillage: This order destroys any terrain improvements (irrigation or mines) present in the square the army occupies. Roads and railroads are unaffected. To pillage, press the Pillage key (the Shift + P keys on the IBM).

Construction (Masonry & Currency)



Aqueduct



Colosseum



Fortress (see page 37)

Settlers

Settlers are groups of your most resourceful and adventurous citizens. As independent pioneers they perform two critical functions for your civilization: they found new cities and serve as engineers.

New Cities: To found a new city, move a Settler to the desired location and press the Build key (the B key on the IBM). The Settler disappears because the people it represents have become the population of the new city. However, in the future the new city can be ordered to produce more Settlers that can be used to found additional cities.

The Build order can also be used to grow an existing city. Move a Settler into an existing city and press the Build key. The Settler is absorbed into the city, adding one point to its population. This may be useful when one city is limited in its ability to expand. This city can be used to produce Settlers who migrate to a larger more useful city where the Settlers can be put to work. However, Settlers may not be added to cities that already contain ten population points or more.

Settler Engineers: Settlers can make a number of agricultural and industrial improvements for your civilization, acting as engineers. Place the Settler in the square where the work is to be done and press the correct key (see the box below). Note that your civilization must possess certain technologies before some improvements can be built.

Key (IBM)	Improvement
Irrigation(I)	Irrigate agricultural lands (Plains, Grasslands, Desert, Hills, and Rivers)
Irrigation(I)	Clear land for agriculture (Forests, Jungles, and Swamps)
Fortress(F)	Build Fortress (any land square - must have Construction)
Mining(M)	Excavate mines (Mountains, Hills, and Deserts)
Mining(M)	Restore forests (Plains, Grasslands, Swamps, and Jungle)
Pollution(P)	Clear pollution (any polluted land square)
Road(R)	Build Road (any land square)
Road(R)	Build Railroad (any Road square - must have Railroad technology)

Diplomats

Diplomats are unique units that can be very useful to your civilization. They may act as trade missions, ambassadors, envoys, secret agents, and saboteurs. They can open contacts with other civilizations and establish embassies to gather information about your rivals. They can act as spies, stealing information and otherwise disrupting your rivals. They can bribe enemy armies. When your civilization obtains the technology of Writing you can build Diplomats.

Be aware that enemy Diplomats can be used against your civilization.

Diplomat Movement: Diplomats may move past enemy armies without stopping. However, if an enemy military army enters the square occupied by the Diplomat, the Diplomat is almost always destroyed. Diplomats may travel overseas in ships as other armies do.

Diplomats (and Caravans) are the only units that can enter defended enemy cities. When a Diplomat enters an enemy city a menu appears listing tasks that can be performed:

Spy on City

Establish Embassy

Steal Technology

Industrial Sabotage

Incite A Revolt

Meet With King

Spy on City: This opens the enemy's city display. You can examine what armies are defending it and what improvements have been made. When you clear the city screen (press the Return key or either mouse button on the IBM), you return to the map display but your diplomat has been eliminated.

Establish Embassy: The Diplomat establishes official contact with the other civilization and continually reports thereafter its type of government, treasury, the name of its capital city, treaties with other civilizations, states of war, and technology advances the Diplomat uncovers. Lists by historians of outstanding civilizations only include those with whom you have established embassies. It is only necessary to establish an embassy once with any civilization.

Steal Technology: Your Diplomat steals one technology advance from the other civilization. This can only be done once per city and your Diplomat disappears in the process (his cover is blown). If you have already stolen from this city, the Diplomat loses its turn. If the enemy civilization has nothing new then the Diplomat loses its turn.

Industrial Sabotage: Your Diplomat destroys either the item currently under production by the city or one of the city's improvements. You cannot control what is destroyed. The Diplomat is lost in the effort. Destroying a critical improvement may throw the city into unrest (Temple, Cathedral), weaken its defenses (City Walls), or cut its production (Factory). Diplomats never destroy Wonders of the World.

Incite A Revolt: Your Diplomat contacts dissidents within a city and for a suitable payment the city revolts and joins your civilization. The payment to revolt depends on the size of the city and its proximity to the civilization's capital. Also, a city in civil disorder revolts for less. Your Diplomat is lost in a successful revolt but escapes outside the city if you refuse to pay the cost. The revolt also fails and your Diplomat survives if you don't have enough cash. Enemy capitals do not revolt.

Meet With King: Your Diplomat opens negotiations with the enemy ruler. This may lead to offers for trading technology or for making treaties. Your Diplomat is not lost.

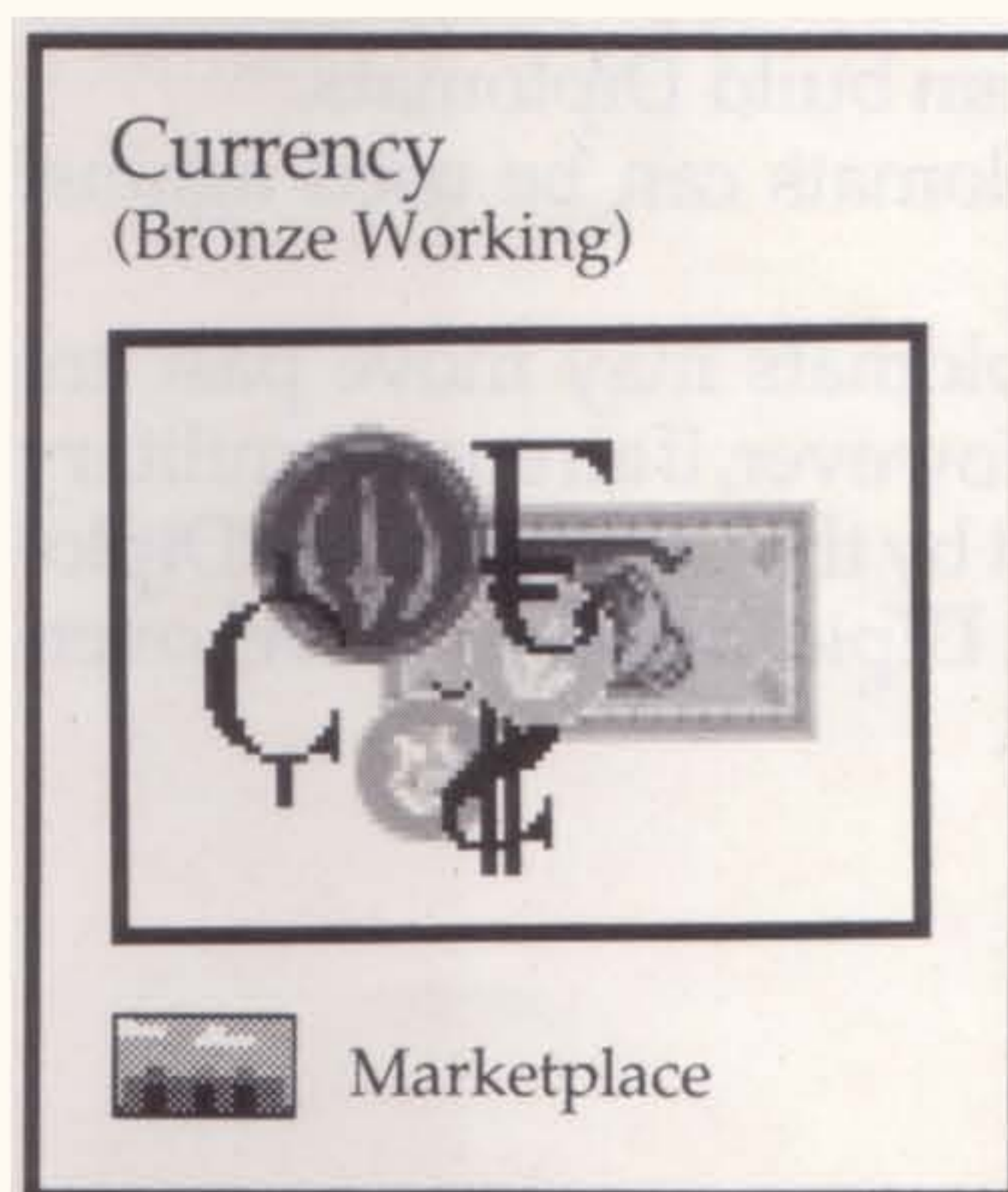

Caravans

Bribing Enemy Units: You may convince an enemy unit to defect and join your civilization by moving a Diplomat into its square. A menu appears showing how much the army demands to defect. If you accept, the cash is deducted from your treasury, the army switches over, and the Diplomat survives. If you fail to make the payment, the Diplomat left on deposit is lost. When more than one enemy unit is in a square, bribery is not possible.

The nearest friendly city becomes the home city for a newly bribed unit (see Home City Roster, page 75).

Caravans are shipments of trade goods and materials. Over time they represent camel caravans, wagon trains, truck convoys, and cargo containers. They may be used to establish trade routes between cities or to transfer resources for the construction of Wonders Of The World. They become available once you have achieved the technology of Trade.

Trade Routes: A Caravan that enters any city of another civilization or a friendly city ten or more squares away from its home city may establish a trade route. This results in an immediate cash payment for delivery plus an increase in the trade generated each turn. This increased trade means more luxuries, taxes, and science for the home city.

Each city may have up to three functioning trade routes. If more than three are established only the best three function.

The amount of trade generated depends partly on the size of the two cities. Bigger cities generate more trade. Trade is best with a city in another civilization. Next best are friendly cities. The farther apart the two cities are, the greater the value of trade. The value is also increased when the cities are on different continents.

Caravans can move into any city they can reach. When at war it may be difficult to smuggle goods into an enemy city without being destroyed. Caravans may be transported overseas in ships as other units are, but cannot be landed into a city directly from a ship.

Building Wonders: A Caravan may contribute its construction cost in resources to the cost of building any Wonder of the World by moving the Caravan into the city where the Wonder is being built. When the Caravan enters, a menu offers the choice of contributing to the construction or not. If you decide to help build the Wonder, the Caravan disappears and the resources used to build the Caravan are added to the production of the Wonder, speeding its completion.

Democracy
(Philosophy & Literacy)



Military Units

The following are the military units that can be built by your civilization. There is a brief description of each unit, including any special abilities. The three numbers shown after the unit's name are its attack, defense, and movement factors. In parentheses after the name is shown the advance required before each unit can be built. In brackets is shown the number of resources it takes to build each unit.

Armor 10-5-3 (the Automobile) [80]: a group of tanks, or other armored fighting vehicles. Due to its high attack factor and speed, Armor is one of the best units for conducting ground campaigns.

Artillery 12-2-2 (Robotics) [60]: a group of self-propelled, heavy caliber artillery pieces. Defenders are not tripled behind City Walls when attacked by Artillery because the guns fire over the walls.

Battleship 18-12-4 (Steel) [160]: a heavily armored and gunned warship. Battleships have a visibility range of two sea squares and may conduct shore bombardments (see page 36). They may not carry ground units.

Bomber 12-1-8(16) (Advanced Flight) [120]: a group of long-range aircraft designed to carry and drop bombs. Bombers may stay airborne for one turn but must return to a base (a friendly city or Carrier) by the end of the second turn. They have a visibility of two squares over any terrain. Bombers ignore City Walls in the same manner as Artillery. They may only be attacked by Fighters. Other units may not enter a square occupied by a Bomber, so they are useful for interdicting enemy movement.

Cannon 8-1-1 (Metallurgy) [40]: a group of carriage-mounted, smoothbore cannons. Cannons are excellent units on the attack and their arrival often opens a new round of offensive wars, especially when accompanied by Riflemen who can stack with them for defense.

Carrier 1-12-5 (Advanced Flight) [160]: an aircraft carrier is capable of acting as a base for Bombers, Fighters, and Nuclear units. Carriers may carry up to eight air units and have a visibility of two sea squares.

Catapult 6-1-1 (Mathematics) [40]: a group of siege weapons designed to throw rocks and other materials with great force. Catapults are useful in the defense and attack of cities, but are weak when left alone on defense.

Cavalry 2-1-2 (Horseback Riding) [20]: a unit of mounted soldiers. Cavalry are useful as scouts and raiders because of their speed.

Chariot 4-1-2 (the Wheel) [40]: a group of light carriages, normally mounted on two wheels and each carrying a driver and warrior. Chariots are a powerful weapon on the attack but very weak on defense. They are also useful as scouts because of their speed.

Cruiser 6-6-6 (Combustion) [80]: a very fast and moderately powerful warship. Cruisers have a visibility of two sea squares and may conduct shore bombardment (see page 36). They may not carry ground units.

Electricity
(Metallurgy & Magnetism)



Fighter 3-3-10 (Flight) [60]: a squadron of fighter aircraft. Fighters are useful as scouts and for attacking enemy Bombers. Fighters must return to a friendly base by the end of each turn.

Frigate 2-2-3 (Magnetism) [40]: a fast sailing warship armed with a substantial number of guns. Frigates may carry up to four ground units (see naval transport 34).

Ironclad 4-4-4 (Steam Engine) [60]: a fast, steam-powered ship armored with iron plating. Ironclads may not carry other units. Ironclads are most useful for attacking enemy ships and less so for conducting shore bombardments.

Knights 4-2-2 (Chivalry) [40]: a group of armored warriors mounted on large powerful horses. Knights are often a useful combination of speed, defensive strength, and offensive strength.

Legion 3-1-1 (Iron Working) [20]: a well-trained force of infantry armed with shields, short swords, and throwing spears. Legions are good offensive units that are relatively inexpensive.

Mechanized Infantry 6-6-3 (Labor Union) [50]: a group of modern infantry mounted on armored vehicles like the Bradley. Mechanized infantry is the best defensive ground unit in the game, useful for defending cities or other important points. It also has a good attack factor and excellent speed.

Militia 1-1-1 (-) [10]: a band of citizens armed with crude weapons, mostly tools and farm implements. Militia are normally the only military unit that you can build when starting a new civilization and are only a stopgap until better units become available.

Musketeers 2-3-1 (Gunpowder) [30]: a company of infantry armed with muskets. Due to their higher defense factor, Musketeers are useful for replacing Phalanxes in positions that need to be defended.

Nuclear 99-0-16 (Rocketry & Nuclear Fission) [160]: a missile weapon armed with a nuclear warhead. A Nuclear unit can only be built after the Manhattan Project Wonder has been built somewhere in the world. A Nuclear unit may move between cities and Carriers. It is lost if it does not end its turn in a city or on a Carrier, and does not attack. It explodes when it attacks an enemy unit or city. A Nuclear attack destroys all military units in the target square and adjacent squares, regardless of who they belong to. Nuclear attacks may also destroy city populations and cause pollution (see Nuclear Weapons, page 53).

Phalanx 1-2-1 (Bronze Working) [20]: a company of infantry armed with long pikes and very strong on the defensive. Phalanxes are very good for defending cities and other important points early on. No other type of unit is as cost effective for defense until Musketeers become available.

Riflemen 3-5-1 (Conscription) [30]: a company of infantry armed with rifles. Riflemen are excellent defenders of cities and other points, and useful for replacing Phalanxes and Musketeers.

Sail 1-1-3 (Navigation) [40]: a small ship powered by sails and lightly armed. Sailing Ships may carry up to three other units by naval transport. They are very useful for exploring the oceans because they are not restricted to staying near the coasts.

Electronics
(Engineering & Electricity)

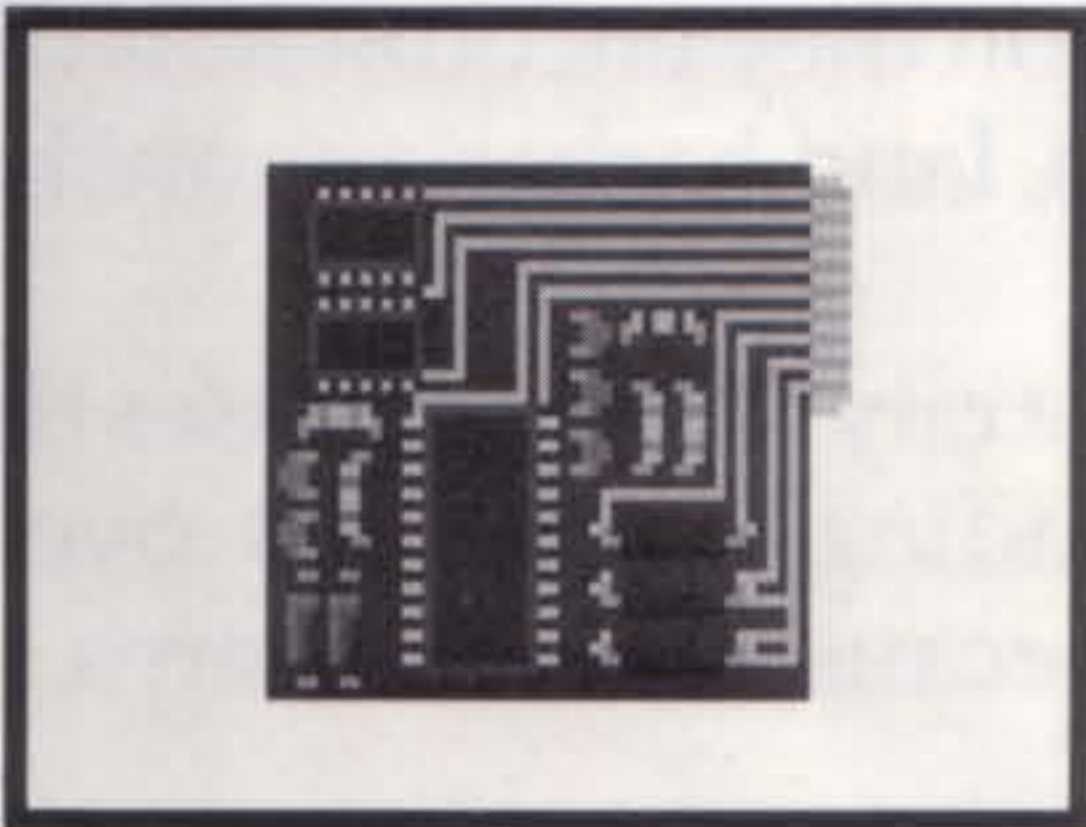

 Hydro Plant

 Hoover Dam

Barbarians

Submarine 8-2-3 (Mass Production) [50]: a warship designed to attack from underwater by firing torpedoes at enemy ships on the surface. Submarines have a visibility of two sea squares and can only be spotted by enemy ships when adjacent. They may not carry ground units or conduct shore bombardment.

Transport 0-3-4 (Industrialization) [50]: a large, modern transport ship. Transports may carry up to eight other units and are very useful when carrying a large force to conduct an invasion.

Trireme 1-0-3 (Map Making) [40]: a small ocean-going ship powered by oars. Triremes are lost at sea approximately half of the time when they are not adjacent to land at the end of a turn. They are normally the first ship that becomes available, and are thus very useful for exploring the sea and transporting Diplomats, Caravans, and other units to nearby continents.

Barbarians are small tribes of raiders that are not part of any opposing civilization. (For the IBM version, they are always red units.) You may encounter them periodically as your civilization begins to expand and grow. They may invade from the sea or arise suddenly in unsettled parts of any continent. Barbarians may attempt to capture or destroy your cities, and pillage your fields and mines.

Because barbarians may appear along any coast or in any unsettled area, it is important to defend cities. It may also be useful to screen your cities from unsettled areas so that any barbarians that appear may be intercepted before they reach your cities.

Most barbarian tribes are accompanied by a leader who may be ransomed if captured. Barbarian leaders look like Diplomats.

Sea Raiders: Barbarians that invade from the sea are looking for a place to settle. They search for cities and attempt to capture them. They do not pillage mines and irrigation because of their interest in making a permanent settlement. If they capture a city, they take it over and begin producing more units to make new assaults. Sea raiders can be fought on land or engaged at sea in their ships.

Land Barbarians: These raiders are interested only in loot, not permanent settlements. This makes them very harmful as they pillage any mines or irrigation they encounter. If they capture one of your cities, they utterly destroy it. For these reasons, land barbarians are best engaged as far from your cities as possible.

Land barbarians arise in areas that are not within the radius of a city. As time passes they appear at even farther distances from civilization. Thus, expanding your cities over a continent eventually removes the threat of barbarians appearing because the entire area has become more or less civilized by the presence of your cities.

Ransoming Barbarian Leaders: If a barbarian leader is alone in a square and you attack him and win, he is captured and immediately ransomed for 100 coins. The money is added to your treasury. When barbarian units are attacked and destroyed, leader units stacked with them are destroyed also. Barbarian leaders who have lost their armies attempt to escape and disappear if not captured in a few turns.

Engineering (The Wheel & Construction)

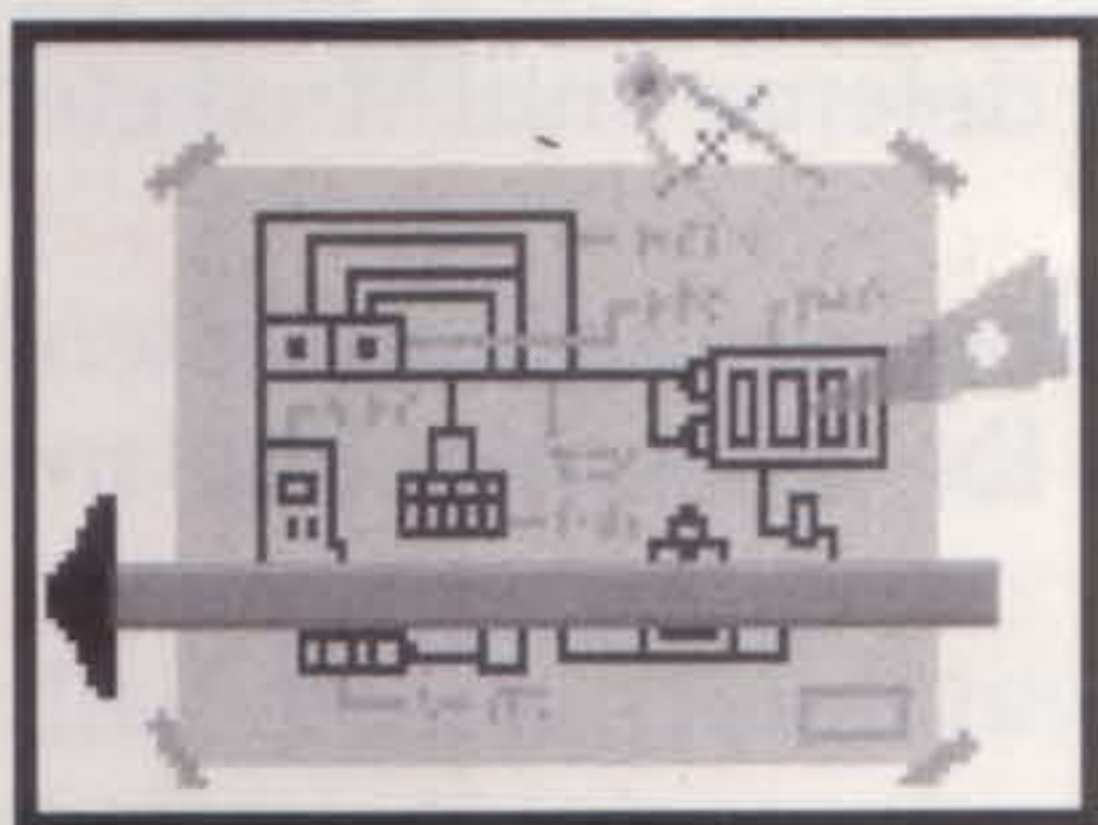

GOVERNMENTS

To assist in the management of your civilization there is a system of government. There are six types of government possible but the ones available to you at any moment depend on the technology that your civilization has achieved. One type of government, Anarchy, only occurs under a special circumstance.

When beginning a new game your civilization is automatically governed by Despotism. The additional types become available when the specific civilization advance bearing their name is made. (Exception, see the Wonder of the World, the Pyramids, page 84.)

The different types of government each have their own unique effects. Some allow greater personal and economic freedom resulting in fast growing trade, science, and economies, while others are better suited to building and employing large armies.

Governments are changed by *revolutions*.

Types

The 6 governments available for a civilization are:

- Despotism
- Anarchy
- Monarchy
- Communism
- The Republic
- Democracy

Despotism: You rule by absolute power. The people just have to live with it because your will is enforced by the army. Due to the minimal amount of economic and personal freedom, production is at a minimum. But your total control makes conducting war relatively easy.

Military units do not require resource support until the number of units making this their home city (shown in the home city roster, see page 75) exceeds the number of people in the city. Each home military unit in excess of the number of people in the city requires one unit of resources for industrial support. Diplomats and Caravans do not require support.

In addition, any map square that produces three or more food, resources, or trade has this production reduced by one. For example, a mine that normally produces three resources produces only two under Despotism.

Settlers require one food for support.

Anarchy: You have temporarily lost control of government. Cities continue to operate on their own but some important operations of your civilization come to a halt until control is restored. You are able to continue controlling the movements of your units.

Anarchy has the same effect as Despotism with several exceptions- no tax revenue is collected, no maintenance is charged for city improvements, and no scientific research is done while Anarchy continues. Anarchy only occurs during revolutions.

Explosives
(Gunpowder & Chemistry)

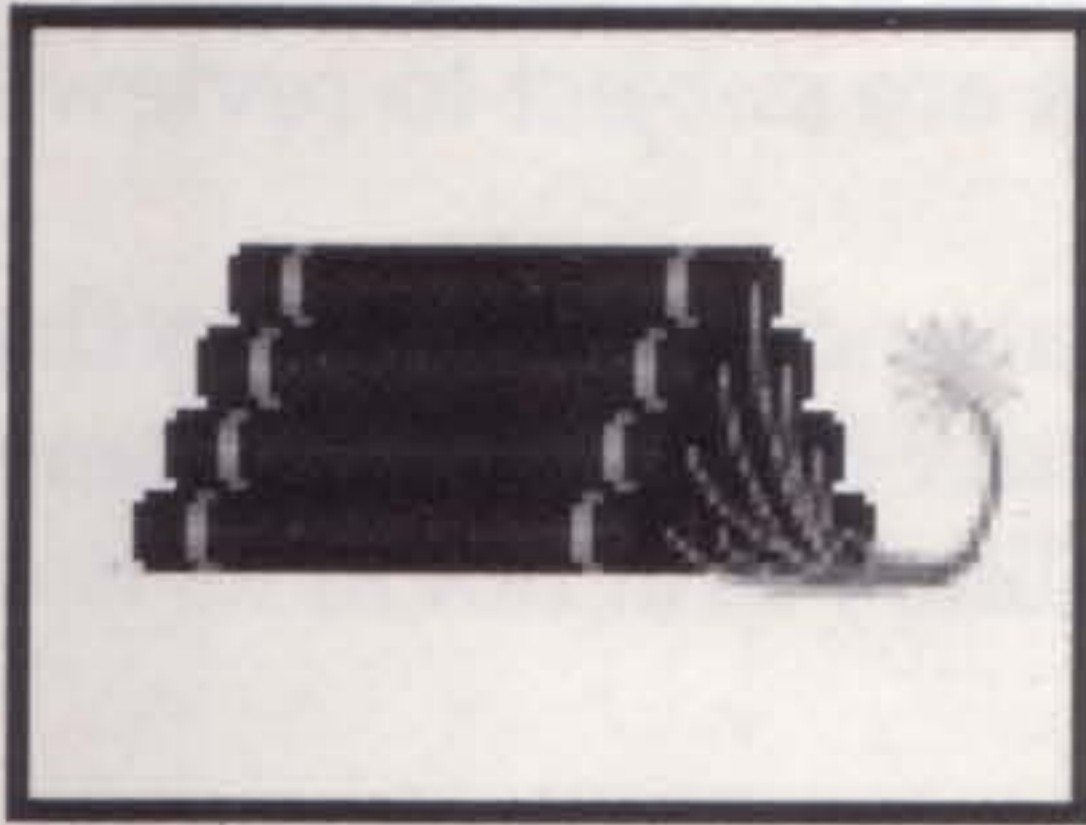

Monarchy: Your rule is less absolute, and more with the acceptance of the people, especially an aristocracy of upper class citizens. The aristocratic classes at least have a certain amount of economic freedom and this results in the potential for greater production of resources, food, and trade. However, the upper classes deduct a share of your civilization's production as maintenance for military units and luxuries in the larger cities.

Under a Monarchy, there is no reduction of production in squares that produce three or more units of food, resources, or trade. Irrigation of Grasslands and Rivers, plus mining of Hills can now pay off with increased production. All military units must be supported by one unit of resources. Settlers require two food for support.

Communism: You are the head of the communistic government, and rule with the support of the controlling party. Although this form of government allows more production than despotism, the orthodoxy of the party restricts personal and economic freedom, limiting trade. On the plus side, corruption is kept to a minimum by the action of the local party apparatus.

Communism has the same effect as Monarchy except that corruption is flat. Instead of increasing the farther a city is located from the Palace, all of your cities suffer the same rate of corruption. (For further discussion of corruption, see the manual section Corruption, page 71.)

The Republic: You rule over the assembly of city-states formed from the cities that your civilization has established. Each city is an autonomous state, yet also is part of the republic that you rule. The people feel that you rule at their request. They have a great deal of personal and economic freedom, and this results in greatly increased trade. Your diplomacy is reviewed by the Senate and they can override your decisions.

Grasslands, Rivers, and Hills are as productive as they are under a Monarchy. Also, an additional trade unit is generated wherever at least one trade unit already exists. Military units each require one resource for industrial support. Settlers require two food. Each military unit not in its home city makes *one* citizen (one city population point) unhappy.

In addition, the Senate of your government accepts any peace offer made by another civilization, overriding even a desire for war by you.

Democracy: You rule as the elected executive of a democracy. The people feel that you rule because they want you to. The degree of freedom allowed under this government results in maximum opportunity for economic production and trade. However, the people also have a very strong voice in determining how much economic production is devoted to improving the standard of living. As in a republic, some diplomatic decisions are subject to review by your Senate.

Democracy is very similar to The Republic. One difference is that under Democracy there is no corruption. Also, if one or more of your cities are in civil disorder for two turns, there is a chance each turn thereafter that a revolution may occur. Each military unit not in its home city makes *two* citizens unhappy.

Feudalism
(Masonry & Monarchy)

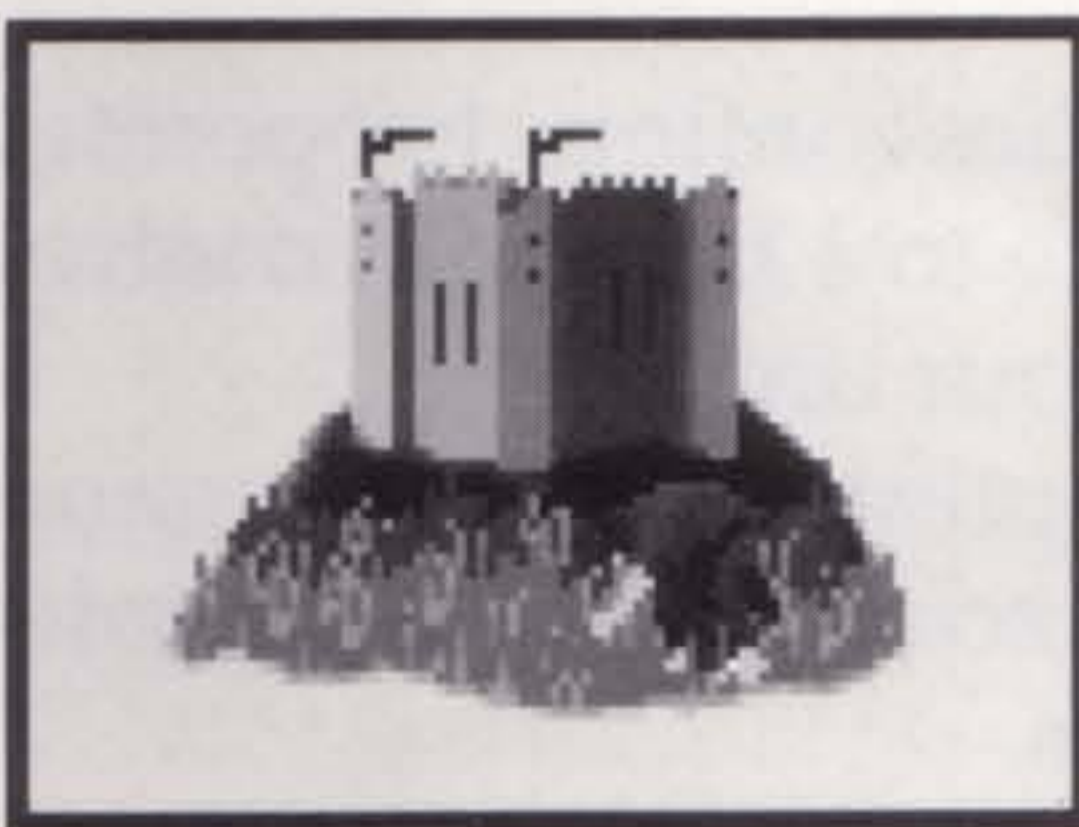

Revolution

Governments are changed through a process of revolution. This normally occurs at your command because you wish to change to a type of government more suitable to your plans. You may change your civilization's government type to any for which you have made the

ADVISORS/WORLD REPORTS

You always have a staff of advisors available who can provide detailed information concerning the affairs of your civilization. By consulting with these advisors you can make informed decisions about the management of your cities and relations with other civilizations. The reports of these advisors can be obtained from the Advisors menu found on the menu bar at the map display.

In addition, there are a number of other reports that can be consulted. These are available from the World menu on the menu bar.

The following advisors and world reports can be consulted:

Advisors:

- City Status
- Military Advisor
- Intelligence Advisor
- Attitude Advisor
- Trade Advisor
- Science Advisor

World Reports:

- Wonders of the World
- Top 5 Cities
- Civilization Score
- World Map
- Spaceships
- Demographics

City Status: This report lists the cities in your civilization and shows what they are producing. For each city you can read the population size, the amount of food, resources, and trade generated, what item is currently being produced, and how near it is to being completed.

It is useful to consult this advisor at the beginning of your turn to refresh your memory about what you are producing and how close it is to completion. You can see at a glance whether some critical military unit or Wonder of the World is nearly completed.

Military Advisor: The first military report shows how many units of each type your civilization currently has in existence and is producing.

Clear the screen to see the second part of the report (for the IBM, press Return, the Spacebar, or any mouse button). This part of the report shows the casualties that you have taken and inflicted in combat with other civilizations. The casualties are shown by type and civilization. Civilizations are differentiated by their color. For example, if one of your rivals is the Aztecs, colored yellow, and there is a yellow "1" in the Ironclad row, this indicates that you have destroyed one Aztec Ironclad. Your casualties are shown in the first column on the left side.

Fusion Power
(Nuclear Power &
Superconductor)

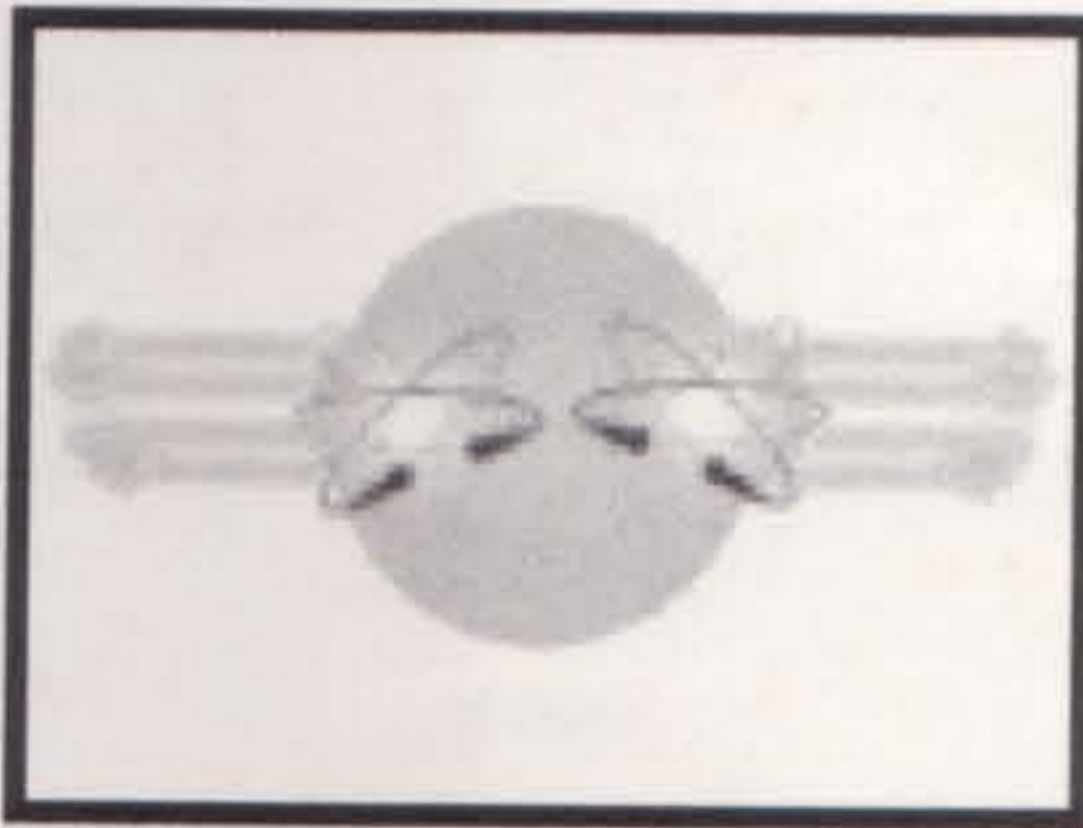

Intelligence Advisor: This report is a summary of information gathered by your embassies. For each civilization with whom you have established diplomatic relations, this report presents accurate data on the name of their capital, their type of government, the size of their treasury, and their diplomatic status with other civilizations. No information appears for civilizations with whom you have not established an embassy. (See Diplomats, page 37, for a discussion of embassies.)

You can learn here which civilizations are at war and which are at peace, and with whom. You may find it useful to consult this report before attacking another civilization. For example, if two of your neighbors are at war, you may consider passing the opportunity to attack one of them yourself. If you do attack, they may make peace with each other and both attack you. By leaving them at war, you are free to concentrate on your own progress while they wear each other down.

A second page of information may be called up by pressing the Info button. (Click on the button with either mouse button on the IBM.) This page reports some additional information regarding the apparent goals of the civilization's leader and the technological advances they have made most recently.

Attitude Advisor: This advisor reports the relative happiness of your citizens. From his survey you can see at a glance the number of happy, content, and unhappy citizens in each of your cities. This information can be very useful after changing your luxury rate or type of government because those changes can have a significant effect on the happiness of your citizens. By reviewing this survey you can quickly see where you may have to make adjustments in city management to avoid disorder.

For each of your cities, you see the current population and icons of any city improvements that help increase the happiness of the people. At the bottom of the page are totals for the size of the population of your entire civilization and percentages of the total that are happy, content, and unhappy.

By examining the roster of improvements for each city, you may see where a city is missing a helpful improvement.

Trade Advisor: Your trade advisor reports for each of your cities how much of its trade is directed toward bringing in luxuries, tax revenue, and new ideas (scientific research). The amount of luxuries, taxes, and science a city is producing is shown to the right of its name. Below the list of cities is a total for tax collections per turn.

On the right side of the report is a list of city improvements that exist throughout your civilization. Only those improvements that cost money for maintenance are listed. The report shows how many of each improvement exist and the cost of maintaining them. At the bottom of this list is the total of your improvement maintenance costs for this turn.

Genetic Engineering
(Medicine &
The Corporation)



 Cure for Cancer

By comparing the tax revenue number with the maintenance cost number, you can see whether the treasury of your civilization is increasing each turn, shrinking, or remaining the same. If your treasury is shrinking, this may be a good time to increase taxes or adjust individual cities to produce higher revenue. In an emergency, you may wish to sell an improvement to raise cash.

The final item in the report is labeled "Discoveries" and shows the number of turns needed for your scientists to acquire the technology advance that you have directed them to seek. The more scientific research done by your cities, the fewer turns required. Note that as technology increases, it takes more and more research to make the next breakthrough.

Science Advisor: Your science advisor keeps track of the technologies that your civilization has already achieved and the progress of your scientists toward their next advance. (In the IBM version, technology that your civilization was first to learn is shown in white.) A chart shows progress toward the next advance. The light bulbs indicate how much research has been done. When the box is full of light bulbs, the advance being researched is achieved.

It is possible to continue making advances beyond the basic list that defines civilization up to the end of the 20th century. These continuing advances are called *Futuristic Advances* and each one you acquire adds 10 points to your civilization score.

Wonders of the World: Your geographers maintain a listing of the location of the Wonders of the World. When they hear of the construction of a new one they add it to the list. By the end of your civilization's history there may be as many as 21 Wonders: 7 ancient, 7 medieval, and 7 modern. Knowing where they are may be useful because capturing the city where a Wonder is located adds to the glory of your civilization.

The geographer's list shows the Wonder's icon, its name, the city in which it is located, and the civilization that built it. Clear the page of ancient Wonders to see the medieval Wonders, and clear again to see the modern Wonders. (On the IBM clear the page by pressing the Return key or either mouse button.) Note that only existing Wonders appear on the list. For more information about the Wonders, see Wonders of the World, page 82.

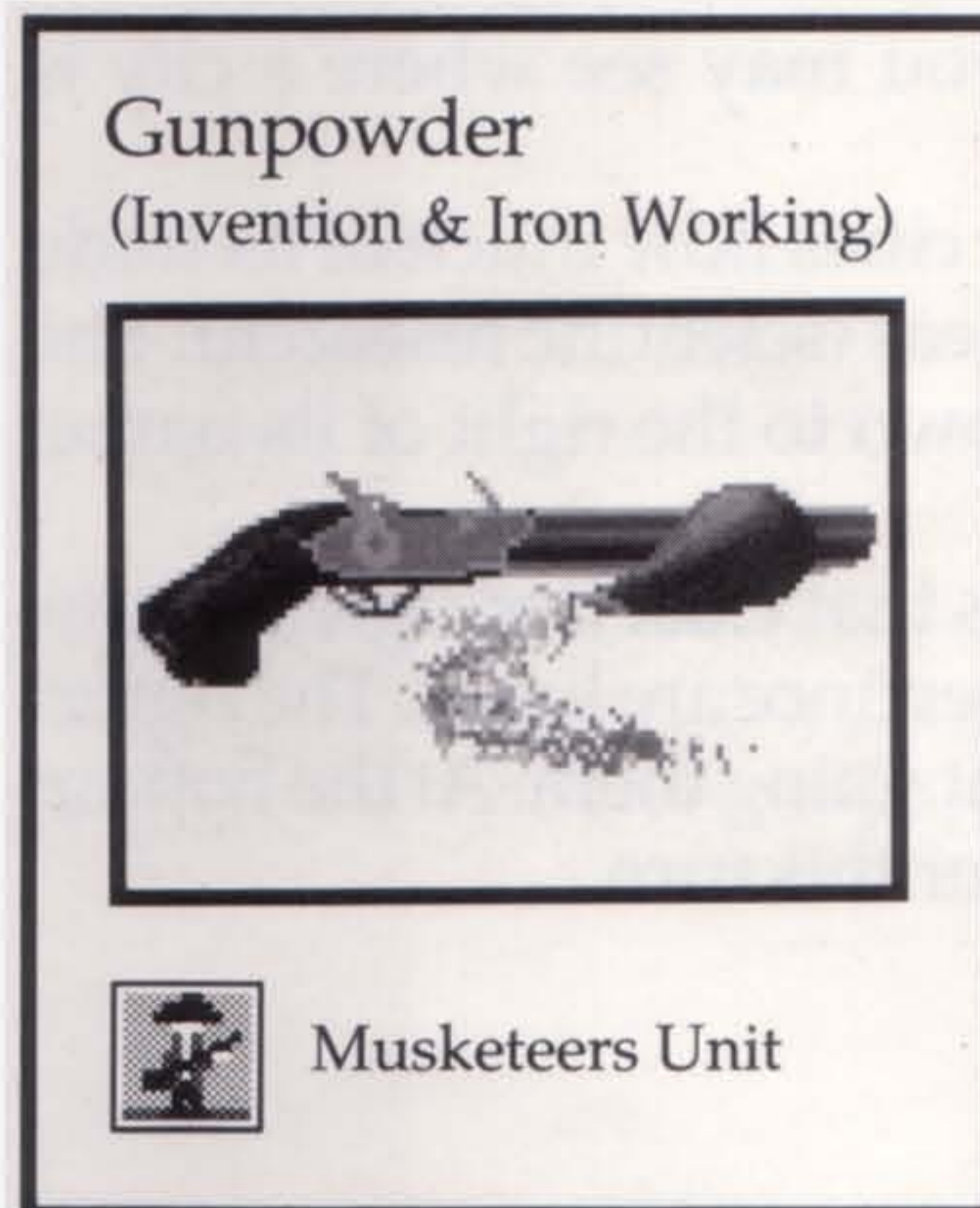

Top Five Cities: This report graphically shows the five highest rated cities in the world. The five cities are named and their parent civilizations are also listed. Below the names are the population rosters of the cities and the icons of any Wonders that have been built there. All cities in the world are rated and the five with the highest scores are put on the list. Cities score points as follows:

2 points: For each happy citizen

1 point: For each content citizen

10 points: For each Wonder of the World built there

Note that cities that you have never discovered can be revealed to you in this list. The magnificence of these cities has passed by word of mouth to the corners of the world. Your geographers and other advisors constantly sift the rumors of travelers and traders for information regarding other civilizations. Even though some civilizations are not known to you, the splendor of their cities has reached the ears of your advisors.

Civilization Score: This is a relative measure of how your civilization is doing. It is also totalled one last time when the game ends to give you a final score for your civilization. You can check with your advisor throughout the game to see how you stand. Your ultimate but difficult goal is to score over 1,000. Points are scored for the following conditions.

2 points: For each happy citizen

1 point: For each content citizen

20 points: For each Wonder of the World that you possess

3 points: For each turn of world peace (no wars)

10 points: For each *Futuristic* advance

-10 points: For each map square currently polluted

At the bottom of the report is a bar graph indicating how far you have advanced towards a civilization score of 1,000.

World Map: Also the work of your geography department, this is a map of the entire known world. Parts of the world that you have not discovered cannot be seen. In addition, this map is centered horizontally on your capital. Thus you cannot tell exactly where you are located relative to the north and south polar boundaries until you discover them.

Spaceships: When you contact your space advisors, they can report the progress of any spaceship under construction. Select from the menu the civilization whose spaceship you wish to examine. Your advisors present a picture of the construction accomplished to date and their assessment of what it can carry, its estimated flight time, and its success probability.

The space race begins once the Apollo Program Wonder of the World has been constructed. Thereafter any civilization that has the required technologies may begin building parts of a spaceship.

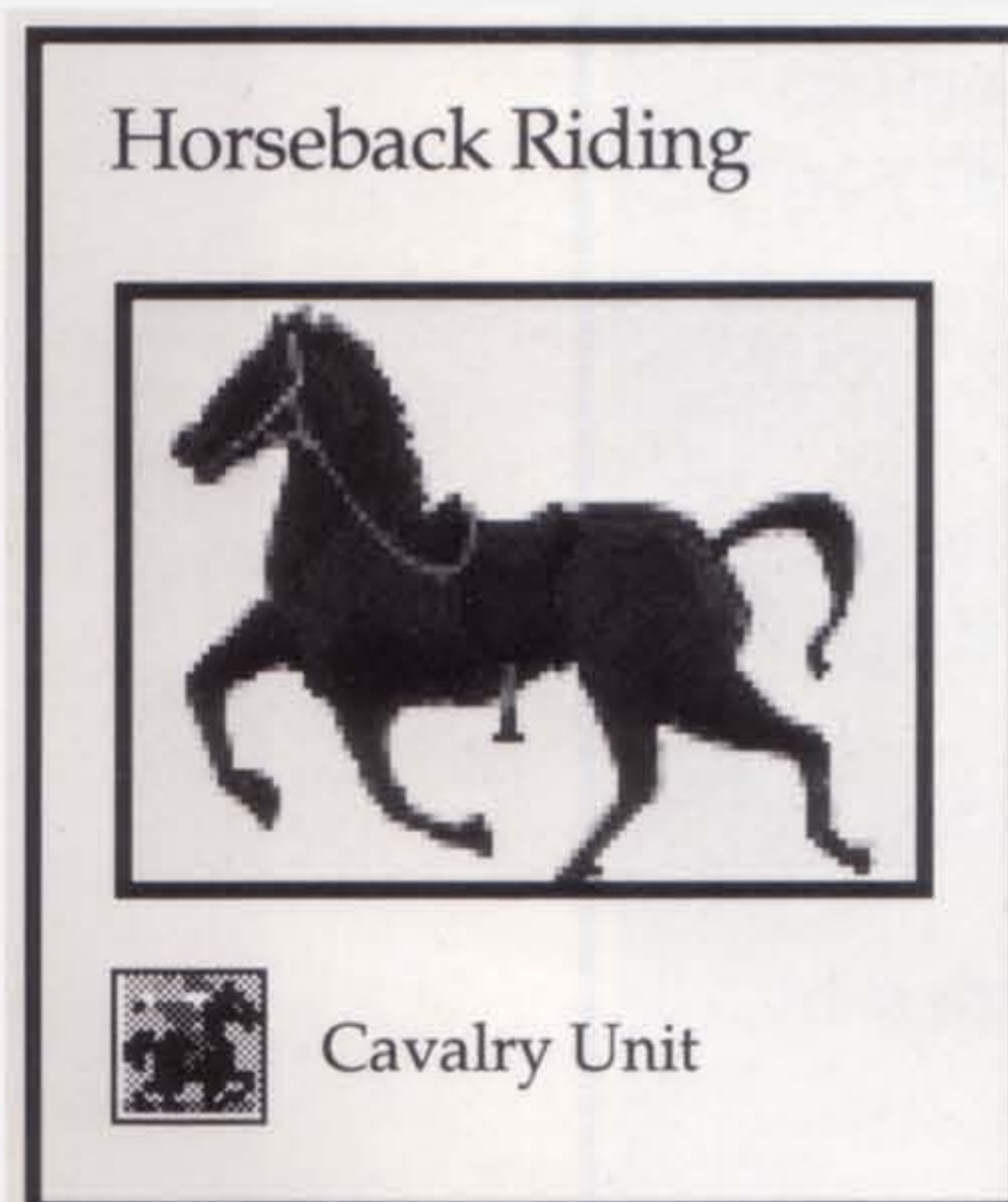

Once the space race begins, it is important to maintain a watch on the spaceships of your rivals. You need to assess when they are likely to launch so that you can plan the size of your own ship and its launch date. If you conclude that your ship construction is too far behind to catch up, it may be necessary to mount a military campaign to capture the enemy capital. Capturing the enemy capital cancels the enemy spaceship under construction.

Demographics: Your advisors keep track of demographic information regarding your civilization in comparison to the others in the world. This information is available in this report. It details your civilization's status in a number of areas and where it ranks in the world. Examining this report may offer clues about which civilizations are your biggest threats.

The following statistics are shown in the report.

Demographics Report

Approval Rating:	The % of the people that think you are doing a good job as ruler.
Population:	The number of people within your civilization.
GNP:	The total of luxuries and taxes generated by your cities.
Manufactured Goods:	The total of resources generated by your cities.
Land Area:	The land squares that your units were last to pass through, representing the part of the world that is under your influence and control.
Literacy:	The % of your population that can read. This depends on acquiring the advances of the Alphabet, Writing, and Literacy, plus the number of Libraries and Universities that your civilization possesses.
Disease:	A relative standing based on whether your civilization has acquired the advance of Medicine, and the number of Granaries and Aqueducts in your cities.
Pollution:	A comparison of the amount of pollution you are creating versus your rivals, measured by the number of smokestacks generated by your cities.
Life Expectancy:	A relative number determined by the extent of disease and pollution in your civilization.
Family Size:	A number determined from the amount of excess food generated by your cities. Large family size means rapid population growth.
Military Service:	A relative standing determined from the number of military units you possess versus the size of your population, indicating the length of time of military service.
Annual Income:	The amount of luxuries and tax revenues your cities generate, divided by your population.
Productivity:	The total of resources, food, and trade generated by your cities, divided by your population.

CIVILOPEDIA

The Civilopedia is an on-line encyclopedia of *Civilization*. It includes reference information on over 150 items of significance in the game. For most items there is a two page entry. The first page is a description of the item and its historical importance, the second page explains the significance of the item in the game.

The Civilopedia can quickly be consulted from the map display. Pull down the Civilopedia menu and select the part that you wish to consult:

Complete: all listings (takes several pages).

Civilization Advances: the 70+ technologies; these are also shown in alphabetical order in sidebars on the manual pages and in the Civilization Advances Chart.

City Improvements: the structures you can build in a city to improve its working, including the Wonders of the World.

Military Units: the units that can be built, including Diplomats and Caravans.

Terrain Types: the various map square terrains.

Miscellaneous: government types, terrain improvements, and other game concepts not covered elsewhere.

After you have selected a section of the Civilopedia, a list of the entries in that section opens. Choose the item you wish to learn about. (On the IBM, click on the one you wish with the LMB or use the keypad keys to move the highlight and press the Return key to select.) This opens a page of the Civilopedia. After reading this page, clear it to read the next page if one exists. (On the IBM press either the Return key, Spacebar, or either mouse button.)

When you have finished consulting the Civilopedia, close it using the Exit button in the top right corner. (On the IBM press, click on the Exit button with either mouse button.)

Sample Civilopedia Entry







CRUISER

Military Unit

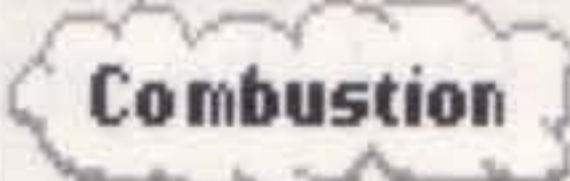
Cruisers have a visibility range of 2 sea squares.
Cruisers may bombard units in coastal land squares.

Requires:

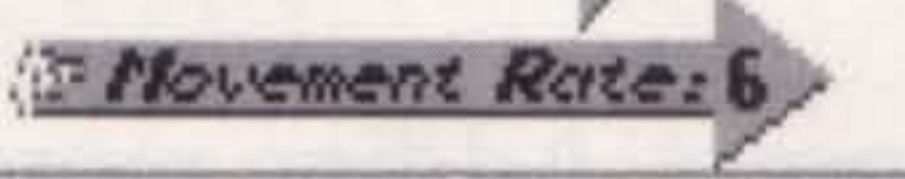
 Combustion	 Cost
 Attack 6 Factor	 Defense Factor 6
 Movement Rate: 6	

PLANETARY CARETAKING

One cost of heedless industrial growth is a gradual polluting and poisoning of the environment. Of the many dangers posed by pollution, the greatest may be global warming. An unchecked rise in the planet's atmospheric temperature threatens catastrophic geographic changes including melting polar ice caps, rising sea levels, and parched farmlands. As you steer your civilization into the industrial age, you must manage your cities to minimize pollution and prevent global warming.

Different kinds of poisoning may occur when nuclear weapons are used or a nuclear reactor melts down.

Every game turn there is a probability of pollution occurring within the economic radius of each of your cities. The probability of pollution occurring depends on two factors: resources and population. The most important factor is the number of resources the city generates. The more that are generated, the higher the probability. Below a certain level, there is no chance of pollution.

The city's population has no effect on pollution until you acquire the advance of the Automobile. Thereafter, the population may become a significant factor in the probability of pollution occurring.

When there is a probability of pollution occurring at a city, smokestacks begin appearing on the city display. The number of stacks indicates the probability. For example, a city generating a large number of resources each turn (say 20) and inhabited by a large population, may show five smokestacks in its city display. This indicates that the probability of a new square becoming polluted is 5% this turn.

Pollution can be cleaned up by Settler units. Move the Settler onto the polluted square and press the Pollution key (the P key for the IBM). The Settler is marked with a "P" to note that it has been ordered to clean up pollution.

After four turns of work, the pollution disappears. Adding more Settlers to a polluted square does not speed the cleanup.

Pollution reduces the production of food, industry, and trade in any map square where it appears. Production is halved and then rounded up. For example, a square that produced 4 food, 1 industry, and 2 trade before pollution produces only 2 food, 1 industry, and 1 trade after. When cleaned up, the map square returns to pre-pollution levels of production.

Industrial Pollution

Cleanup

Effects

Monitoring Pollution

Your environmental advisors immediately inform you when any map area becomes polluted. The area on the map is marked with smudges (black in the IBM version) to indicate pollution.

The extent of pollution throughout your civilization can be monitored by watching the pollution indicator, a small sun in the date window of the map display. The color of the sun indicates the extent of the risk of global warming. The colors in the IBM version range from dark red, to light red, to yellow, to white. Dark red indicates a low risk and white indicates a very high risk.

The colors of the sun depend on the number of squares currently polluted and a lag of time. The more squares polluted, the higher the risk. The lag reflects the time required for the pollution to take effect.

Global Warming

Effects: Global warming causes geographic changes throughout the world. Deserts, Plains, and Grasslands on coasts may become Swamps, and coastal Forests may become Jungles. Plains, Grasslands, and Forests in the interior may become Deserts. The result is much lower food, industry, and trade for your civilization.

Your environmental advisors report immediately if global warming has occurred. The effect is always bad, but in the case of flooded coastal areas you may improve Jungles and Swamps over time.

Causes: Global warming may occur if at least nine map squares, anywhere in the world, are currently polluted. If they are left unattended for too long, environmental damage occurs.

Once an environmental disaster has occurred, the cycle starts over again. The planet has achieved equilibrium at the new higher temperatures. If pollution continues or increases once more to high levels, another bout of environmental problems may occur. This cycle may repeat endlessly if pollution is not controlled.

Nuclear Pollution

Pollution may also be caused by nuclear weapons or the meltdown a nuclear power plant. Pollution caused by either of these events has the same effect as industrial pollution.

Nuclear Weapons: When a nuclear unit is used in an attack, an additional effect of the attack is the pollution of a number of map squares around the impact square. Remember this when you are tempted to use nuclear weapons. You may create pollution you cannot readily reach with Settlers to clean up, significantly raising the risk of global warming.



Nuclear Meltdown: If a Nuclear Power Plant melts down, half of the city's population is destroyed and a random number of squares near the city become polluted.

There is risk of meltdown when a city that has a Nuclear Power Plant goes into civil disorder (see page 66). The civilian unrest may result in safety procedures becoming so lax that a catastrophic accident occurs. If you build Nuclear Power Plants in any of your cities, take special care not to allow those cities to go into disorder.

When your civilization achieves the technology of Fusion Power, the risk of meltdown disappears. Your Nuclear Plants automatically convert to the technology of fusion power, which is free of the risk of meltdown.

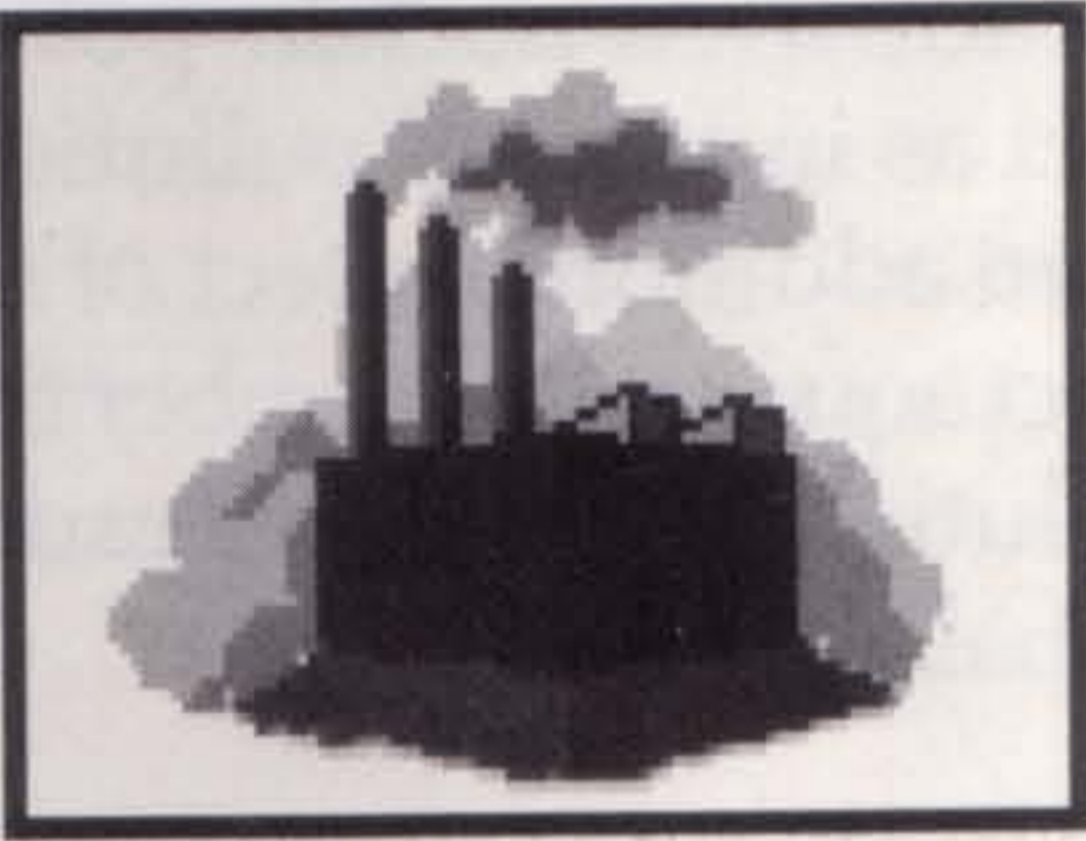
Industrialization
(Railroad & Banking)



-  Transport Unit
-  Factory
-  Women's Suffrage

DIPLOMACY

Diplomacy is conducted by negotiations between yourself and a ruler of a rival civilization. Negotiations may occur when a rival sends an envoy to talk or may result from overtures of your own. Diplomacy is conducted face-to-face with one rival ruler at a time and can lead to exchanges of technology, offers of peace, international extortion, or declarations of war.

A rival may contact you when units from each of your civilizations are adjacent to each other. A rival envoy may also arrive at any time. You may start negotiations by sending a Diplomat into a rival city and selecting the option "Meet With the King."

The tone and result of any negotiations are greatly influenced by the mood of your rival. The opposing leader may be antagonistic, supplicating, or somewhere in between. This mood depends on the leader's personality and how your two civilizations compare to each other and to the rest of the world. You may be able to pick up cues on a rival's mood from facial expressions or background music.

A rival leader's personality may be aggressive, friendly, or neutral. Aggressive leaders are more likely to lean toward war or demand high payments for peace. Friendly leaders are more likely to offer peace and may only be bluffing when asking for payment. If you have broken previous peace agreements with this civilization, that is remembered and also influences the degree of antagonism.

If you are the largest, most powerful, and richest civilization in the world, all rivals are likely to be very jealous or antagonistic. However, if the opponent is puny in comparison, the natural tendency toward being belligerent may be overridden. A civilization threatened with extinction is more interested in survival.

All negotiations end with either an agreement of peace between your two civilizations or a declaration of war. Even the most antagonistic rival may concede peace for a suitable payment of cash or technology. This may purchase peace only temporarily, however.

Establishing embassies with other civilizations can be very useful in preparation for negotiations. Your Intelligence Advisor collects information from all of your embassies and from him you can learn important facts about your opponents, including their size and the personality of their leader. This information is not available for civilizations with which you have not established an embassy.

Trading Technology: Civilizations that are not extremely antagonistic may offer to trade technology. They begin by offering one that you don't possess. They may actually have several you lack. If you agree, a menu of technologies they can trade appears. Select the one that you want and then they take one from you. You have no choice regarding what they take and cannot veto the trade. If after trading another exchange is possible, more trading may take place.

Invention
(Engineering & Literacy)

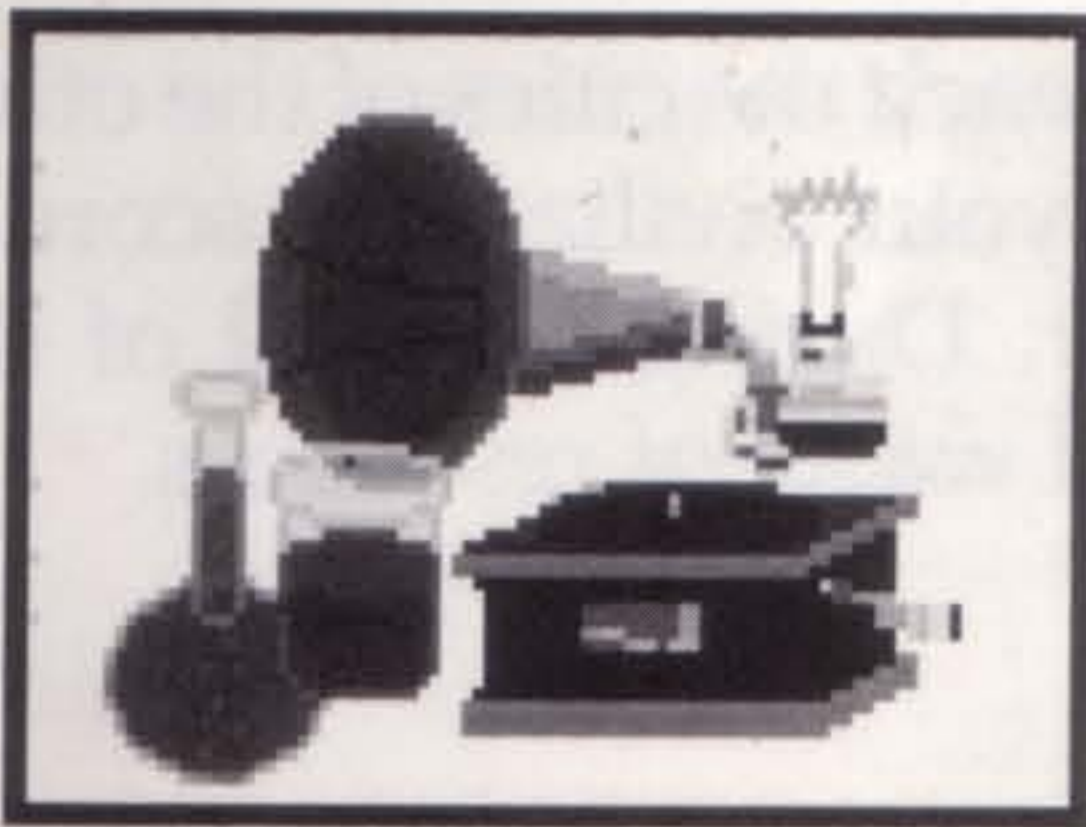

Peace

Buying Peace: A rival may demand a cash payment or a civilization advance during negotiation. If you meet this demand, the rival almost certainly agrees to peace. If you reject the demand, an antagonistic rival generally declares war. The demand of a more peaceful or threatened rival may only be a bluff, and peace may be offered anyway after demands are rejected. In some cases, a rival offers a reward for your making peace or declaring war on another civilization.

Post-Treaty Negotiations: Once you agree to a peace treaty you have an opportunity for further negotiations. A menu opens offering three choices: a declaration of harmony, a military proposal, or a demand for tribute. The declaration of harmony has no real effect. A military proposal is a suggestion by you for your new friends to attack a third party. This generally costs you a cash payment which you can pay or turn down.

The third option is a demand for tribute to cement the new treaty you have signed. If your opponent is weak or in awe of your power, he may pay. Alternatively, he may refuse to pay, or go so far as to declare war on you.

Peace between your civilization and another can only result from diplomacy. If you and your rival agree, then a state of peace can occur. Choosing peace is voluntary unless your government is a Republic or Democracy. In those cases the Senate of the government overrules any decision for war and accepts peace.

Peace agreements can normally be broken at any time by either party, but so long as it holds, both parties must adhere to the following rules: units of the other civilization, even Diplomats, may not be attacked; no units except Diplomats and Caravans may enter squares that have been improved by the other party within the radius of a city (irrigated, mined, or penetrated by roads); squares that the other party has under development may not be pillaged; and technology may not be stolen from the other party. Any of these events ends the peace and triggers war. You are warned that you are about to break a peace and have a chance to check your action.

If your government is a Republic or Democracy, you may not voluntarily violate a peace agreement. The Senate forbids any action that starts war. If you consider war necessary, you must have a Revolution to overthrow the government and put in one more receptive to your wishes. Alternatively, you may wait for your opponent to break the peace himself or declare war on you.

When you are at peace it is much easier for trade Caravans to reach the cities of the other party and establish trade routes. If the entire world is at peace, your civilization score is increased. The major benefit of peace is that you are not at war. During war, all of the proscribed activities are possible, and can cause great damage and waste of resources.

Iron Working
(Bronze Working)



Legion Unit

THE SPACE RACE

The environmental pressures of growing populations in the modern world are forcing humans to look into space for resources and living room. The question is not whether humans are to travel to the stars, but when. The final act of stewardship you can perform for your civilization is to insure that they lead this exodus.

As noted earlier, the history of your civilization ends when either you or one of your rivals reaches a nearby star system with colonists. If your spaceship is the first to arrive, you receive a bonus to your civilization score in recognition of this final accomplishment. Regardless of how many colonists your spaceship is carrying, or how fast it is, if a rival makes planetfall first, you receive no bonus.

The construction of spaceships may not begin until one civilization has built the Apollo Program Wonder. Thereafter, the race is on and any civilization that has acquired the necessary advances may begin building the parts of a spaceship.

Each civilization, including yours, may build only one spaceship at a time. Once it is launched, another one cannot be built and sent off. Ships that have been launched may not be recalled or turned around. Spaceships are destroyed if the owning civilization's capital is captured. In this case, a new ship may be constructed.

Spaceships

The purpose of your spaceship is to carry as many colonists as possible to another star system. To have any chance of success it must provide at least a minimum of the following: living space for colonists, food sources, energy sources, propulsion power, and fuel for the engines. The better prepared the spaceship, the higher the number of colonists that arrive safely and the faster the voyage.

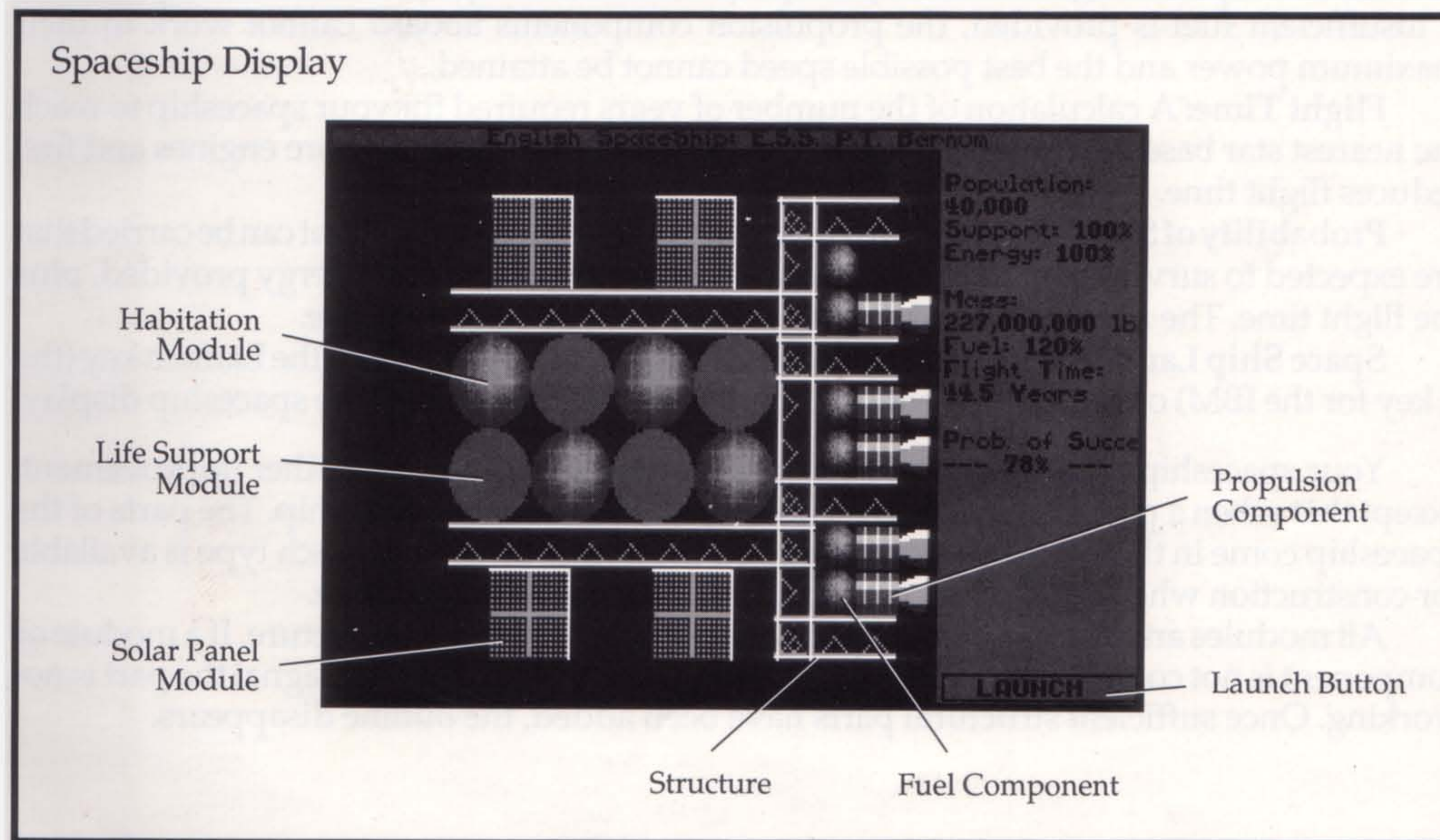

Your goal is to build a spaceship that can hold as many colonists as possible, yet travel at a reasonable speed and with a reasonable probability of success. As construction of your ship proceeds, keep an eye on its characteristics, displayed to the right of the spaceship window. All spaceships have the same characteristics: population, food, energy, mass, fuel, flight time, and probability of success.

Once you have built a spaceship that meets the minimum requirements for carrying colonists, you may launch or proceed with further construction to increase the capacity of the ship.

Population: The number of people the spaceship is outfitted to carry. The more people it carries to the new planet, the higher your bonus.

Support: The percentage of the people that the ship is prepared to carry that can currently be supported. People that are not provided with life support cannot be expected to survive the voyage.

Energy: The percentage of the energy required by the habitation and life support modules that is currently being provided. If sufficient energy is not provided for life support and habitation, the probability of success will be very low.

Mass: All of the components, modules, and structures add to the mass of your spaceship. The greater the mass, the more power required from propulsion parts to move it.

Fuel: The percentage of the fuel your propulsion units require that is currently aboard. If insufficient fuel is provided, the propulsion components aboard cannot work to their maximum power and the best possible speed cannot be attained.

Flight Time: A calculation of the number of years required for your spaceship to reach the nearest star based on the ship's mass and engine power. Adding more engines and fuel reduces flight time.

Probability of Success: The approximate percentage of the people that can be carried that are expected to survive the voyage, based on the amount of food and energy provided, plus the flight time. The faster the flight, the higher the expected survival rate.

Space Ship Launching: To send your spaceship on its voyage, press the Launch key (the L key for the IBM) or the Launch button, found at the bottom right of the spaceship display.

Your spaceship is constructed of parts. Each part is built like any other improvement, except that when a part is completed, it is automatically added to your ship. The parts of the spaceship come in three types: components, modules, and structures. Each type is available for construction when you have achieved a specific technology advance.

All modules and components must be connected to a sufficient structure. If a module or component is not connected, it is marked (outlined in red on the IBM) to signal the part is not working. Once sufficient structural parts have been added, the outline disappears.

Construction

To build spaceship components you must have achieved the technology advance of Plastics. You can then build components at a cost of 160 resources. There are two kinds of components, propulsion and fuel. When a component has been completed, you choose which type has been built.

Propulsion Components: These are the engines that provide the power for space flight. The more engines you add, the faster the ship travels, the sooner it reaches its destination, and the higher the probability of success of the mission.

Fuel Components: These provide fuel for the propulsion units. In order for the propulsion units to perform to their maximum, one fuel component must be provided for each propulsion component.

Modules

Spaceship modules require the technology of Robotics and cost 320 resources each to build. They exist in three types: habitation, life support, and solar panels. When a module is completed, you choose which type to add to your ship.

Habitation Module: Each habitation module provides living space, community services, and recreational facilities for ten thousand colonists.

Life Support Module: Each life support module provides the food and other requirements for the ten thousand colonists carried in one habitation module. People carried in a habitation module that doesn't receive life support have a very low probability of surviving.

Solar Panel Module: Each solar panel module provides enough energy to power two of the other types of module. Modules that don't receive power cannot function properly.

Structures

Spaceship structures require the technology of Space Flight and cost 80 resources each to build. You must build sufficient structure parts to connect the components and modules together. Parts that are not connected do not work and provide no benefit to the ship.

Labor Union
(Mass Production &
Communism)



Mech. Inf. Unit

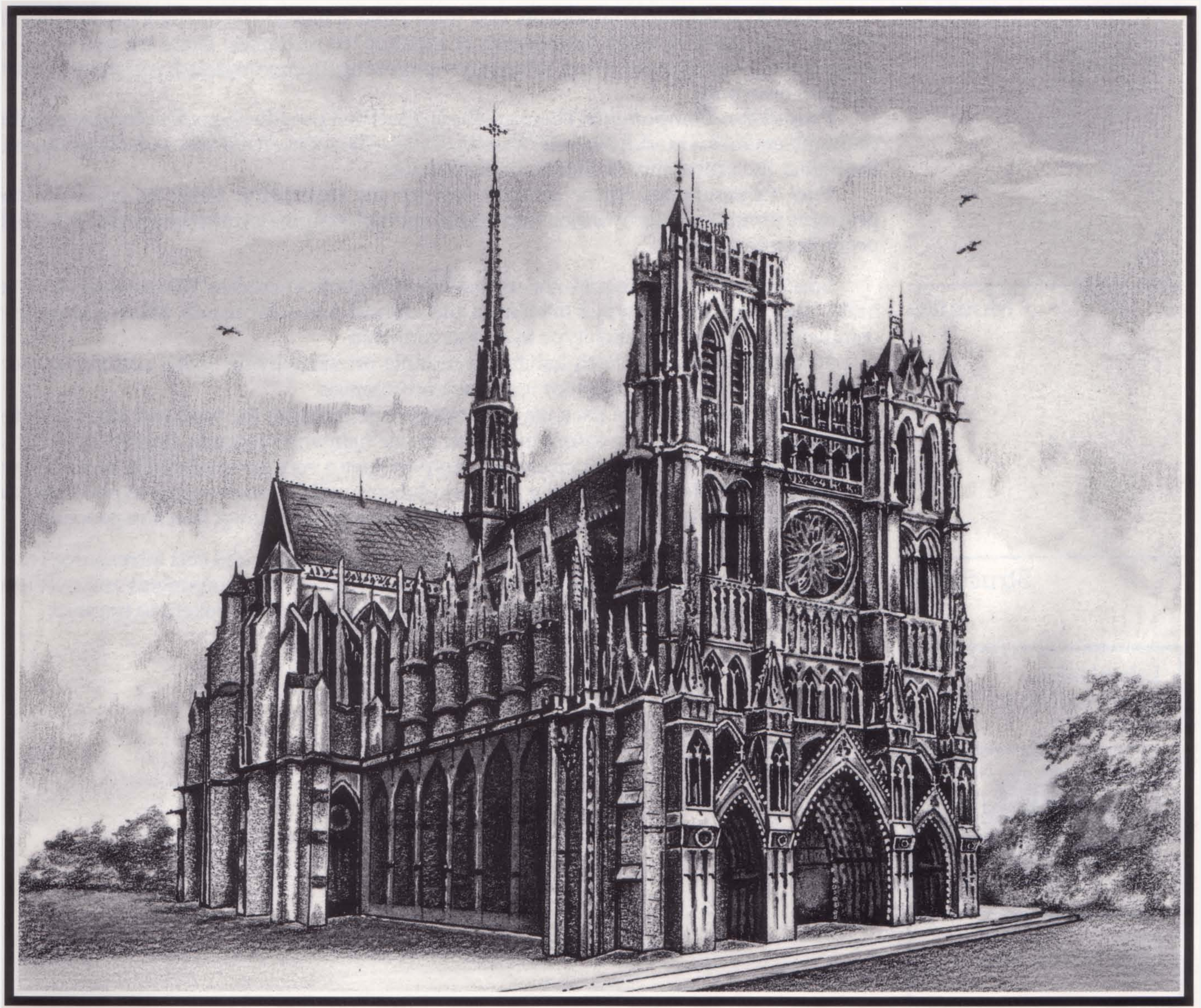

3. CITIES

CITIES

The economic and industrial centers of your civilization are its cities. They are the residence of the population, the source of tax dollars, the home of your scientists, and the sites of your industrial production. Each city organizes the development of the area surrounding it, converting the nearby agricultural land, natural resources, and potential trade into food, industrial production, technology, and cash.

One measure of the success of your civilization is the number of cities it encompasses and the size of each. Larger cities collect more taxes, conduct more technology research, and produce new items faster. Small civilizations, both in numbers of cities and the sizes of each, risk being overrun by larger and more powerful neighbors. Falling too far behind in the arms race, both in quality and quantity, may result in an early exit from history.

The management of your civilization involves the founding of cities, their management, and their protection. New cities can be built from scratch or captured from rivals. Managing a city requires maintaining a balance of food, industry, taxes, luxuries, and improvements that keeps the citizens content and productive.

Rival civilizations are a constant threat to the security of your cities. After taking steps to protect them, consider conquering cities of your rivals. This reduces the threat they pose and is often an inexpensive way to expand.

New Cities

New cities can be acquired in three ways. They can be started from scratch, a minor tribe discovered by your armies may elect to join you as a new city, or your armies can conquer the cities of your neighbors.

Founding New Cities: When a Settler unit is on a map square where you wish to build a new city, press the Build key (the B key on the IBM). You can accept a name your advisors propose for the new city or type in a name you prefer. Enter the name when you are satisfied. (Press the Return key on the IBM). The city display then opens so that production and economic development can be arranged as desired. When the display is closed, the new city is on the map and the Settler unit has disappeared, having become the first citizens of the city.

Minor Tribes: As your armies explore the world they may encounter minor tribes. Occasionally a minor tribe may be sufficiently awed by your emissaries to immediately become part of your civilization. In this case, the minor tribe forms a new city of your civilization.

Capturing Cities: Cities of other civilizations are normally defended. If the defenders can be destroyed, a friendly army may move into the city and capture it. A captured city is thereafter managed and controlled by you in the same manner as any other city. Capturing an enemy city may also result in the discovery of a new technology advance and plundered cash.

Occupying an enemy city may destroy some improvements the city has built, and it eliminates one point of population. Therefore, a city that has only one point of population remaining is destroyed instead of captured.

Placing New Cities

When building a new city, plan carefully where it is placed. The map square in which it is built and the squares surrounding it determine how valuable the city can become. Factors to be considered include the economic value of the square the city is placed in, the economic potential within the city's radius, the proximity of other cities, and the strategic value of the location. Ideally, locate cities in areas that offer a combination of food for population growth, resources for production, and trade. Where possible, take advantage of the presence of special resource squares.

The City Square: The terrain the city occupies is especially important because it is always under development. You cannot take workers off of this square when adjusting development on the city map (see City Map, page 69). If this area is not useful, especially for producing food, then population growth in a new city is handicapped. For this reason, new cities are generally best built in Plains, Grasslands, or Rivers. These provide the best food production and, thus, faster population growth.

The City Radius: The potential area of development extends out from a city two squares on the map in every direction except diagonally. If the city grows large enough, its population can bring all of this area into development. When planning a new city, consider this radius and the long-term benefits of any potential site.

To grow, the city must encompass sufficient food-growing areas. Any city that can grow has value, but your most important cities are those that also have resources available. These cities can quickly build and support military units and Wonders. Hills and Forests are important sources of resources, as are squares containing special resource symbols for game, horses, coal, and oil.

The importance of trade in generating taxes and technology makes River squares especially good sites for cities when just beginning. Without Rivers, you must quickly build roads in Plains or Grasslands to generate trade.

Literacy
(Writing & Code of Laws)



Great Library

Landscaping: When surveying sites for a new city, keep in mind the potential for some squares to be improved. Hills and Mountains can be mined and then produce increased resources. Plains, Rivers, and Grasslands can be irrigated and then produce more food. Swamps and Jungles can be cleared into Grasslands or converted to Forests. Forests may be cleared into Plains. Plains and Grasslands may be turned into Forests if you need resources. An area of Jungles and Swamps looks barren at first, but has the potential to be a very rich city site.

Plains, Grasslands, and Deserts produce trade once penetrated by Roads, and all land squares improve in production when Railroads come through.

Proximity of Cities: Another consideration when planning new cities is the current or potential location of other cities. Minimize the economic radius overlap of your cities as much as possible. Since a map area may only be used by one city, too much overlap restricts the potential growth of one or both cities. When just beginning, explore nearby lands as soon as possible to begin planning the placement of future cities to best take advantage of the terrain. A few large and powerful cities are more useful than several smaller, weaker ones.

Strategic Value: The strategic value of a city's site is a final consideration. Because the underlying terrain can increase the defender's strength when under attack, in some circumstances the defensive value of terrain may be more important than economic value. But good defensive terrain is generally poor for food production and inhibits the early growth of a city.

However, defending a city is generally easier than defending normal terrain. In a city you can build the City Walls improvement which triples the strength of defenders. Also, in cities only one army at a time is destroyed in combat. Outside of cities, all armies stacked together are destroyed when any army in the stack is defeated. So, in certain cases where a continent bottlenecks and a rival is on the other side, the defensive value of a city site may be more critical than economic value.

Placing at least a few cities on the seacoast gives you access to the ocean. This allows the launching of ship units to explore the world and transport your units overseas. With few coastal cities, your seapower is constrained.

There are several goals for management of a city: keeping it stable (avoiding civil disorder), keeping its population growing, maximizing a useful mix of economic development (food, resources, and trade), producing tax revenue, producing technology research, and producing useful units and improvements.

Stability: Cities that don't maintain a favorable balance of happy people over unhappy people go into civil disorder (see below). Cities in civil disorder produce no tax revenue, no technology research, and no food surpluses, and suspend production. A nuclear reactor in a city suffering civil disorder may experience a *meltdown* due to lax safety controls (see Nuclear Meltdown, page 54). Keeping a city stable is a very high priority.

City Management

Population Growth: Keeping the population growing is important because each additional person contributes something to your civilization. Each new worker brings a new map square under production. Population growth increases economic power, and thus, the strength of your civilization. The size of your population is a major factor in determining your civilization score, a measure of how well you have ruled.

Resource Development: The people of your city that work in the surrounding countryside harness the economic resources of the area. Those resources are converted by the city into more people, industrial production, money, and technology research. When managing a city, you must allocate the people so as to maximize this development, or match it up to your needs.

There may be times when increased industrial output is preferred over population growth. There may be times when increased trade is needed. You can give orders to your advisors to shift a city's work force around to change the mix of economic development as desired.

Tax Revenue: Most of the improvements that can be built within cities require money for maintenance. Money is also useful for speeding industrial production (see Rush Jobs, page 74), bribing enemy armies (see page 74), inciting revolts in enemy cities (see page 38), and for negotiating peace with your neighbors. The combined tax revenues of your cities must exceed their maintenance requirements before cash can accumulate for other uses.

Although it is not necessary for each city to produce surplus revenue, enough cities must do so to cover expenses. Some cities may not be especially suited for industrial production, but may still be good trading centers. Manage these cities to produce extra revenue.

Technology Research: The greater the contribution of research each city makes toward new technology, the faster the new civilization advance is reached. The amount of research done in each city is a function of the science rate. This is a percentage of the city's trade that is devoted to bringing in new ideas and otherwise discovering technology advances. A city's research contribution can also be influenced by adjusting trade, creating Scientists (see page 72), and certain improvements. Improvements that can help are the Library and University, which improve research, and several Wonders.

Industrial Production: Each city has more or less capacity to produce new units and improvements. The most valuable cities have the greatest industrial capacity. They can quickly produce expensive military units that extend the power of your civilization. They are also best at producing the Wonders of the World. You must regularly monitor the production of your cities to insure that the most needed items are being built.

There are four main tools available to reach and maintain these goals of city management: shifting workers around, converting some workers to *Specialists*, building improvements, and building Wonders of the World.

Workers can be shifted around the city map display to adjust economic development (see the manual section City Map, page 69). Specialists can be created to increase production of luxuries, taxes, or technology (see the manual section Specialists, page 72).

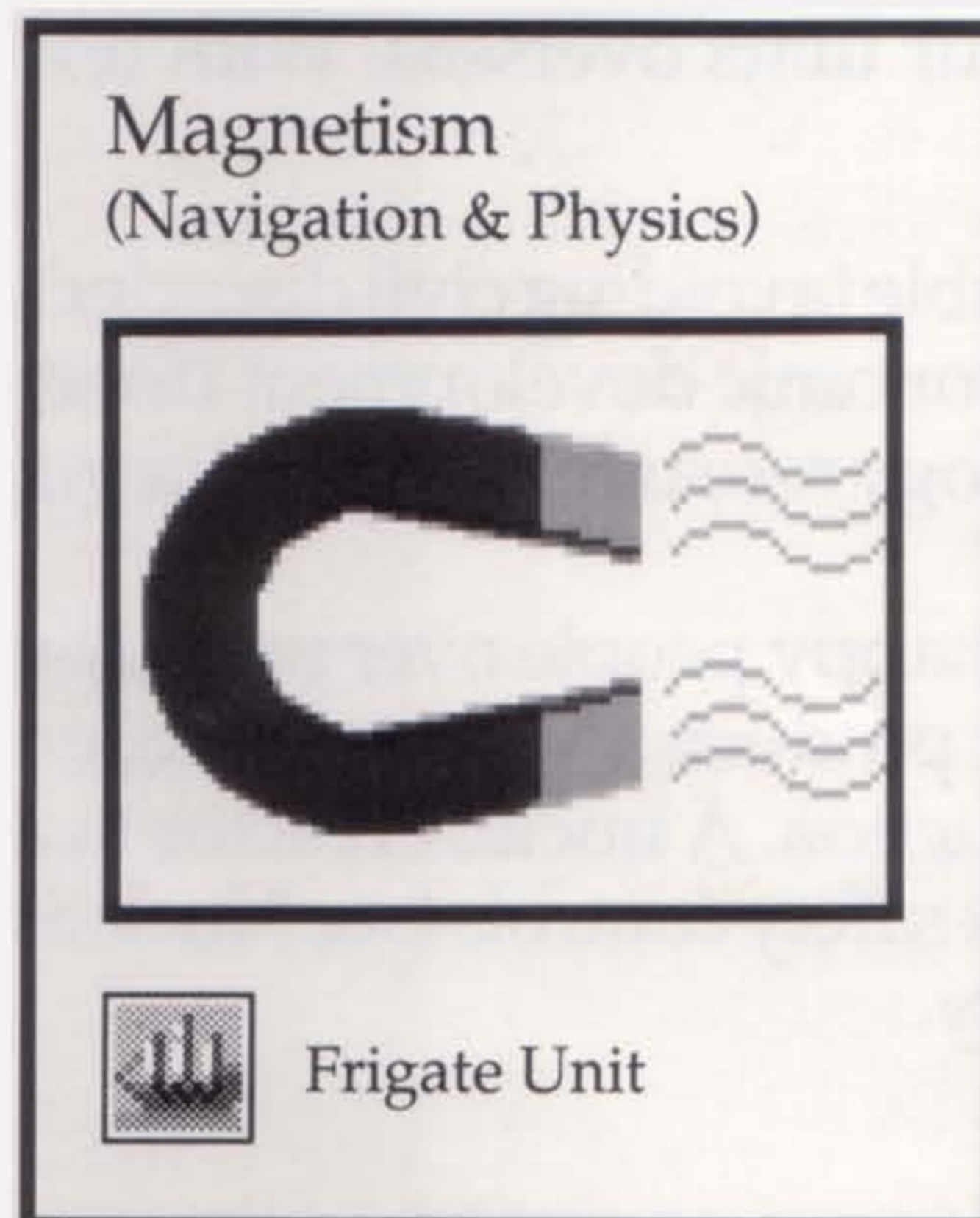

Within each city you can order the construction of improvements such as a Temple to make some unhappy people content, a Granary to speed population growth, or a Library to increase research. See the manual section City Improvements, page 78, or consult the Civilopedia for the list of possible city improvements. From either source you can also learn the construction and maintenance cost of each improvement, its purpose, and what technology is required to make it available.

The most costly tools available are the Wonders of the World. These are magnificent improvements that bring lasting glory to your civilization in addition to some special effect. The possible Wonders are described in the manual section Wonders of the World, page 82, or in the Civilopedia. Although Wonders are built in a city like an improvement, their special effect often extends through all or part of your civilization. However, only one of each Wonder may be built in the entire world and your rivals may construct them first.

City Protection

Great economic management of a city is worthless if the city is captured by rivals or barbarians. Part of the management plan must concern the defense of the city. A large part of the defense is not handled locally, but on your borders and coasts. A defensive line of units, both at sea and on land, that can intercept enemies before they close with your cities can be helpful.

Even the best defensive lines can be penetrated, so the defense of the city itself cannot be neglected. The minimum city defense is one army, preferably one with a good defense factor. Fortify any armies that you expect to defend a city (by pressing the F key on the IBM) because Fortified units increase their defense strength. A second defender is often a good idea. Adding an army with a strong attack factor is also useful. This army can attack enemies that move adjacent to the city, perhaps destroying them before they test the defenders.

The defense of the city can be substantially improved by building City Walls, an improvement that triples the defender's strength versus most attackers, but not Bombers or Artillery. This tripling takes effect after the effects of veteran status is considered. Being fortified behind City Walls has no effect unless the attacking unit is a Bomber or Artillery unit. City Walls also prevent population loss when defending units are destroyed.

When civilization advances make available new army types with better defense factors, take the first opportunity to replace old defenders with better units. Since the offensive capability of your enemies improves as they acquire new technology, your defenses must improve to keep up.

Linking cities with Roads and Railroads can be very helpful in speeding the movement of units from one end of your empire to trouble spots elsewhere. This puts your defensive armies on "interior lines," allowing them to rapidly move to where they are needed.

Map Making (Alphabet)

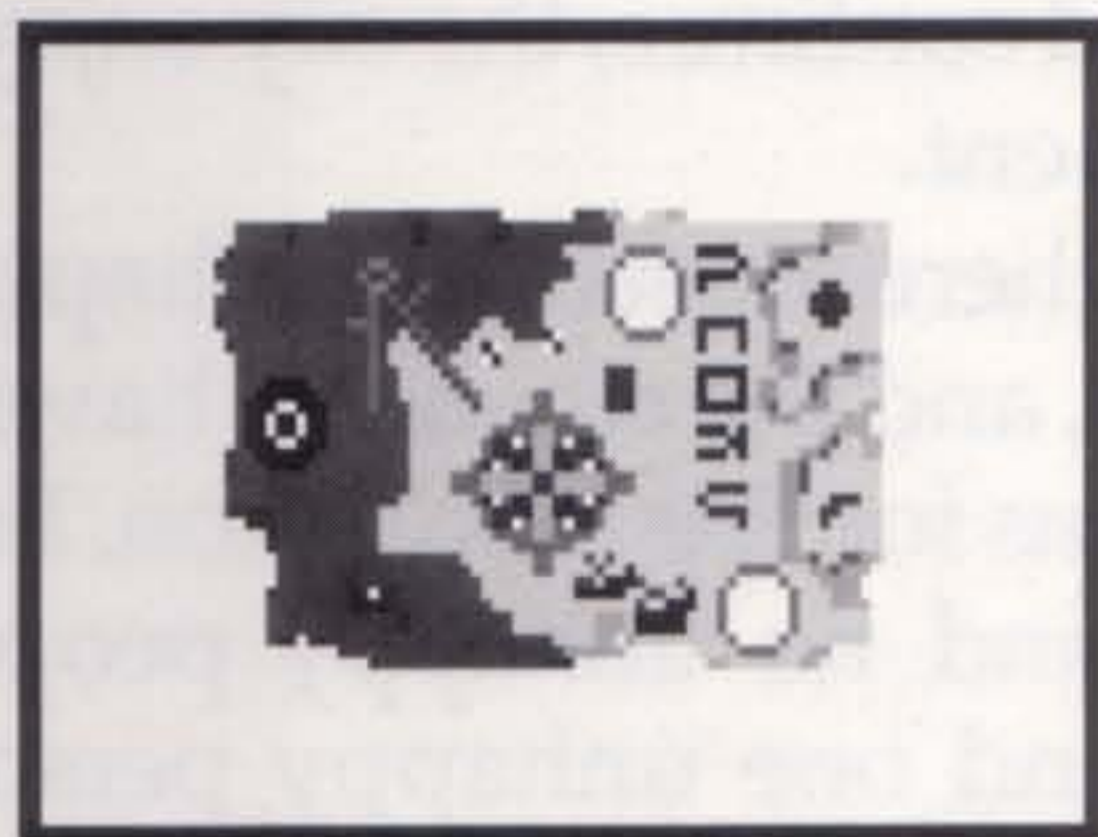

Trireme Unit



Lighthouse

Civil Disorder

A city suffers civil disorder when unhappy people outnumber happy people, content people being ignored in the calculation. Cities in disorder provide no tax revenue, contribute no technology research, and suspend production of new units or improvements. When order is restored, the city returns to normal operation next turn. You can restore order in several ways.

To restore order you may pay to complete an improvement, such as a Temple, that can convert sufficient unhappy people to contentment (or content people to happiness) to restore balance. See the manual section Rush Jobs, page 74, for how to do this.

You may also change the luxury and tax rates of your civilization to attempt to restore order. Increasing luxuries may convert some content people to happy.

You may take one or more people out of the work force, making them Specialists. This increases the number of happy people. For information on how to do this, see the manual section Specialists, page 72. When creating Specialists, be careful not to also cause shortages of food or resources that cause starvation of population or scrapping of armies.

Under the government types Despotism, Monarchy, or Communism, it is possible to restore order to a city using *martial law*. Each military unit in a city makes one unhappy citizen content. Only those units possessing an attack factor of 1 or more can impose martial law. By moving enough units into a city suffering disorder, order may be restored.

Under Republican or Democratic government, each military unit not in its home city creates one or more unhappy citizen. When a city is in disorder, destroying distant military units, returning them to the home city, or changing their home city, makes some unhappy people content and may restore the city to order.

All of these methods are useful in restoring the balance of your cities or enemy cities that you have just captured.

We Love The (King) Day

When a city becomes sufficiently happy, it may hold a celebration in honor of your rule. The people declare a “We Love the (King) Day” in thanks for the prosperity you have made possible. While the circumstances that trigger this celebratory mood continue, the city enjoys certain benefits, depending on your civilization’s type of government.

In order for the “We Love the (King) Day” celebration to occur, there must be no unhappy people in the city, at least as many happy people as content people, and the city must have a population of at least three. Specialists are considered content citizens for this calculation. For example, a city with five happy people, four content people, and no unhappy people celebrates. A city with ten happy people, three content people and one unhappy person does not.

Anarchy: The celebration has no effect when the government is in Anarchy.

Despotism: The celebrating city is operated as if the government is a Monarchy. This can increase the amount of food and resources generated when some terrains are irrigated and mined.

Monarchy/Communism: A celebrating city currently ruled by either of these governments is operated as if the government is a Democracy instead. This increases the amount of trade generated.

Republic/Democracy: A celebrating city currently ruled by either of these governments increases in population by one point each turn so long as sufficient food is available. This can result in dramatic growth of the city.

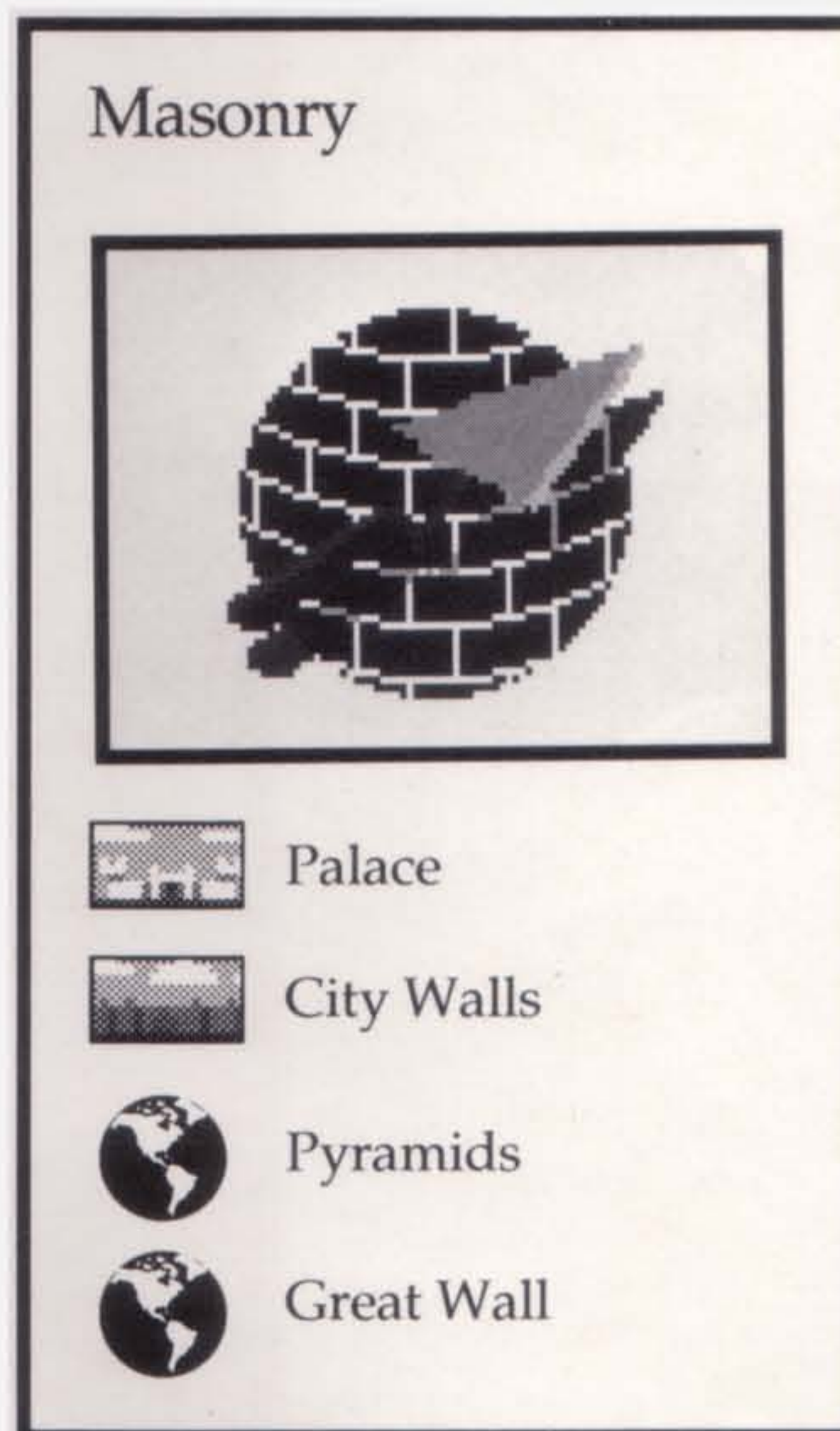

THE CITY DISPLAY

The operation of each city is directed from its city display. Here you assign the population to work in the surrounding fields, mines, forests, and fishing grounds. Here also you determine what unit or other item the city is to produce. The display provides in one place critical information concerning the city's status: how much food, resources, and trade it is generating; what it is producing and how close the item is to completion; the happiness of the population; what is defending the city; and what improvements have been built.

This display is opened from the map window. (On the IBM, click the LMB on the city's map square.) The city display is closed with the exit button. (On the IBM, click the LMB on the exit button.)

The city display consists of the following parts: city map, city resources window, population roster, food storage box, production box, improvement roster, information window, and the home city window. Each part performs a specific function or reports information.

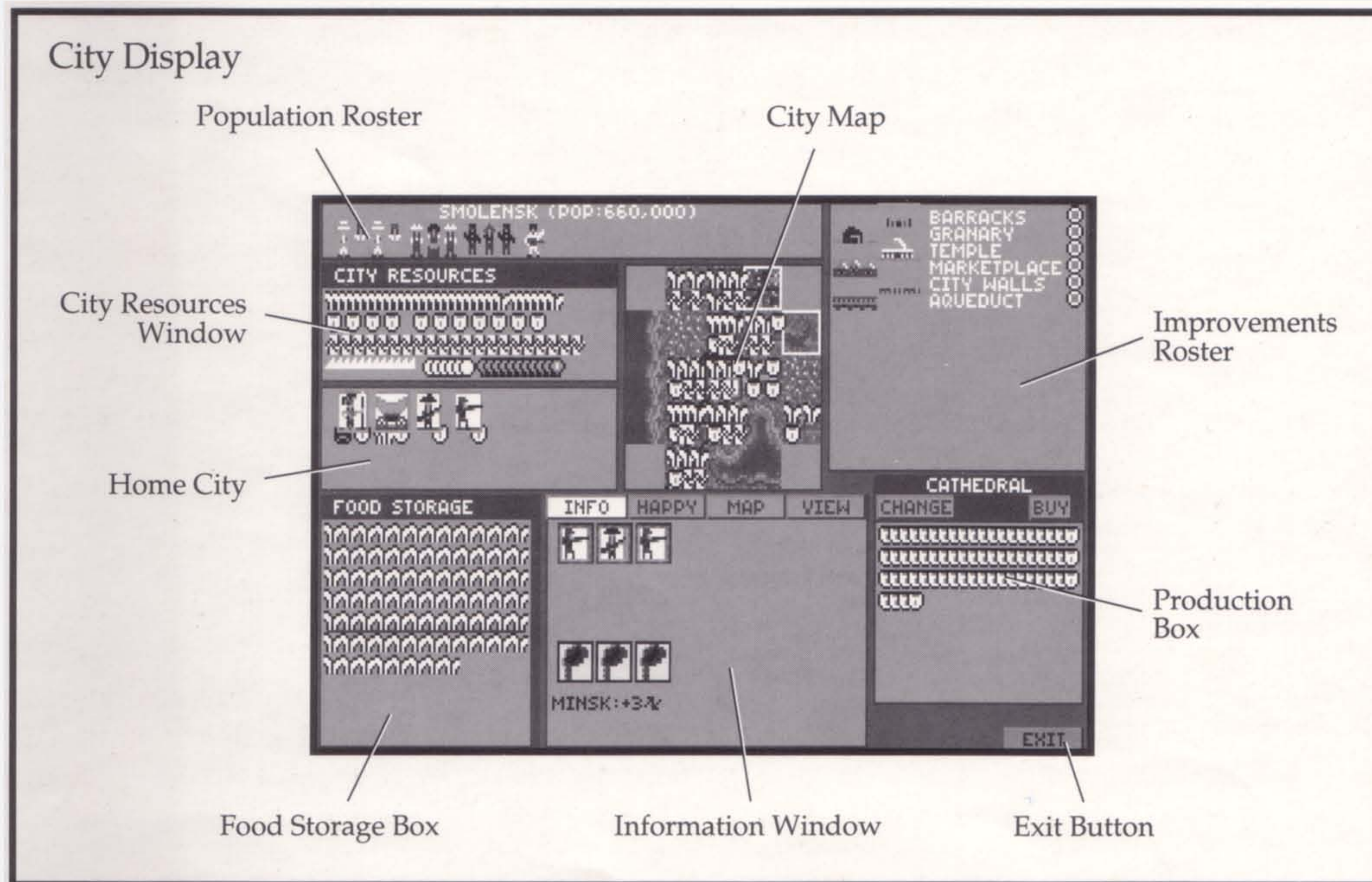

City Map

This shows the map squares surrounding the city that may be developed by the city's population. The maximum number of squares that a city may put in development equals the number of people plus one, but the additional one is always the city square itself. Note that it is possible to have more population than places to put them to work.

Depending on the type of terrain in a map square, putting people to work there may generate food (the grain symbol), resources (the shield symbol) or trade (the arrows symbol). Most squares produce a combination of several items. You may move people from one square to another as you wish to change the mix of food, resources, and trade the city generates.

People removed from the city map are temporarily converted into Specialists (see below) in the population roster. When they are put back to work on the map, they convert back to normal people. (To remove people on the IBM, place the mouse pointer on the correct map square and click the LMB. To put them back to work, place the pointer on the city map square where you wish them to go and click the LMB again.) As people are removed, replaced, and

switched around, the resources generated by the city also change.

When the city population increases, the new people are automatically assigned an area to develop. You may wish to review the map of a city that has just increased in size to be certain the workers have been placed as you wish.

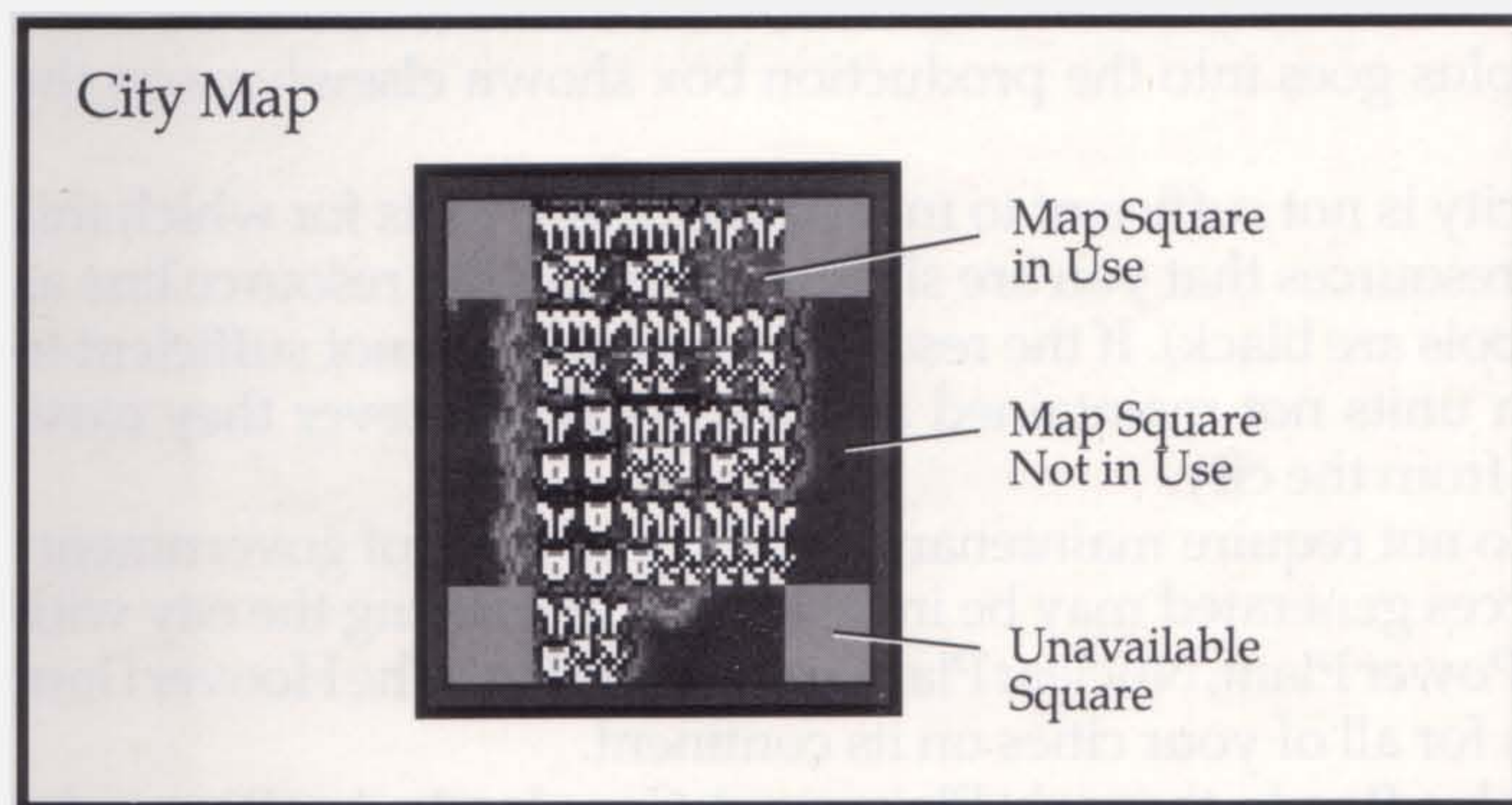

City Resources Window

This window shows the amounts of food, resources, trade, corruption, luxuries, taxes, and scientific research generated by the city's people. These commodities are the raw materials of your civilization. They are brought into the city and there become new people, new units, city improvements, Wonders of the World, cash, and civilization advances.

Food, resources, and trade are collected each turn from the city map squares. In some cases the amount of a commodity collected may be increased by the presence of a certain improvement in the city, or ownership of a certain Wonder. For example, a Factory improvement increases resource production by 50%. A city that produces 10 resources from its city map actually has 15 resources to spend if it possesses a Factory. Trade is further divided into three commodities that it brings in: luxuries, cash, and science (knowledge). The division of trade depends on the trade rates shown in the status report of the map display. Under certain conditions, some trade is lost as corruption.

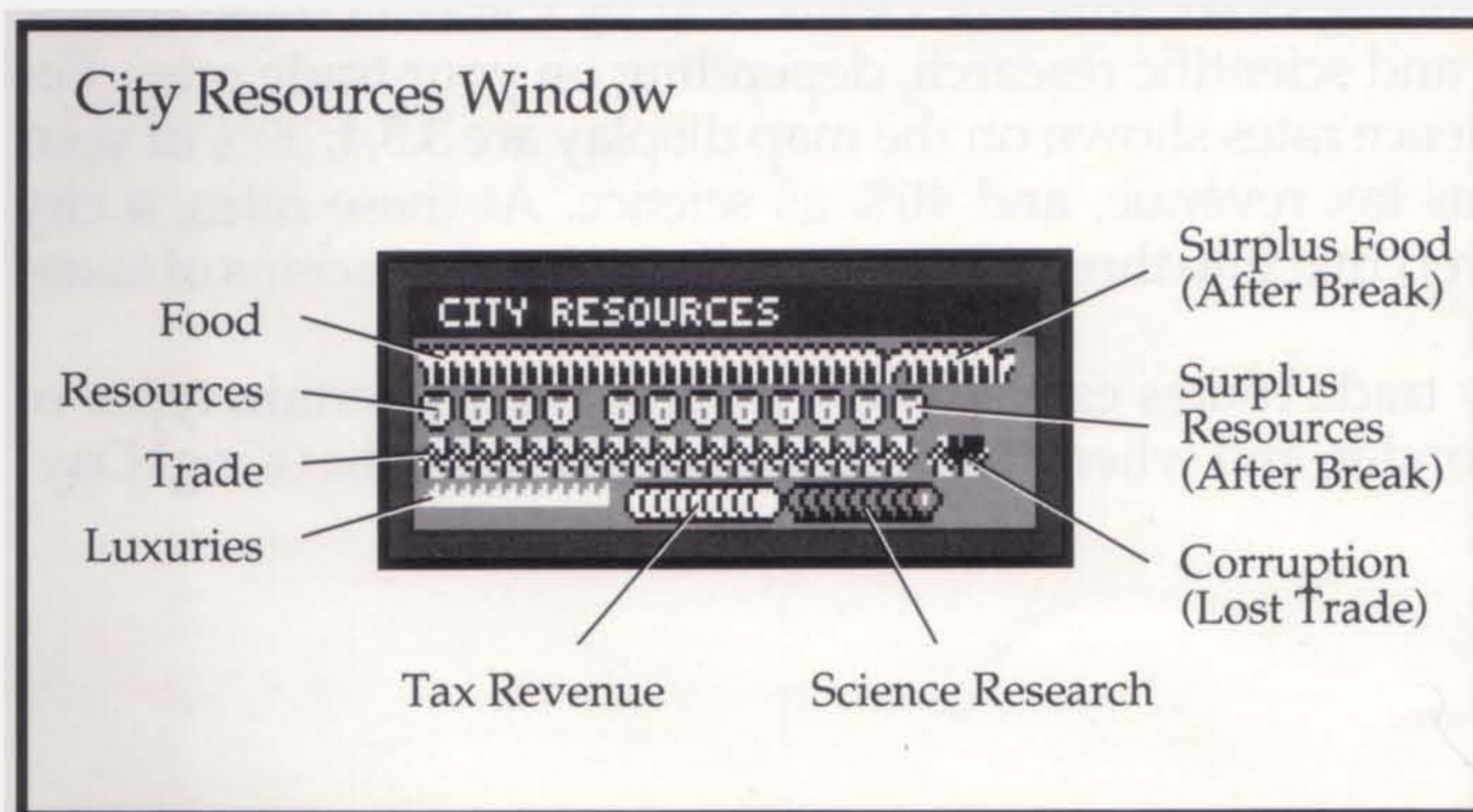

Food: A population point in your city requires two units of food each turn. If your city is currently producing more food than that, the surplus is shown after a break in the food line. The excess goes into the food storage box shown elsewhere on the city display and described below.

If you are not producing enough food to feed the population, the amount of food that you are short is shown as a shortfall in the food line (on the IBM, a shortfall is shown by black food symbols). Each turn this shortage cannot be made up from food in storage the city's population decreases by one point.

Existing Settler units that a city has produced also require one or two food units per turn, depending on your type of government.

Resources: The shield symbols indicate the resources of raw materials and industrial capacity of the city. Depending on the form of government of your civilization, part of your capacity may be required to maintain units that the city has previously built. Surplus capacity is shown to the right of a break in the industry line and is available to be used to build new units or city improvements. This surplus goes into the production box shown elsewhere on the display and described below.

If the city's industrial capacity is not sufficient to maintain existing units for which this is the home city, the amount of resources that you are short is shown in the resource line as a shortfall (on the IBM, the symbols are black). If the resources available are not sufficient to maintain all existing units, then units not maintained are destroyed wherever they exist, beginning with the one farthest from the city.

Diplomats and Caravans do not require maintenance under any form of government.

The basic amount of resources generated may be increased by improving the city with a Factory, Manufacturing Plant, Power Plant, Nuclear Plant, or Hydro Plant. The Hoover Dam Wonder improves the resources for all of your cities on its continent.

Trade: Trade is produced by Roads through Plains and Grasslands, by Rivers, by Oceans/Lakes, by squares containing Gold Mines or Gems, and by Caravan trade routes. Trade arrives as luxuries, taxes, and scientific research, depending on your trade rates. For example, if your luxury/tax/science rates shown on the map display are 3.3.4, 30% of your trade arrives as luxuries, 30% as tax revenue, and 40% as science. At these rates, a city generating ten trade would convert that into three diamonds of luxuries, three coins of taxes, and four light bulbs of research.

Trade may be increased by trade routes established by Caravans, by certain types of government, by the Colossus Wonder, and when a city celebrates "We Love the (King) Day" (see page 66).

Mass Production
(Automobile &
The Corporation)

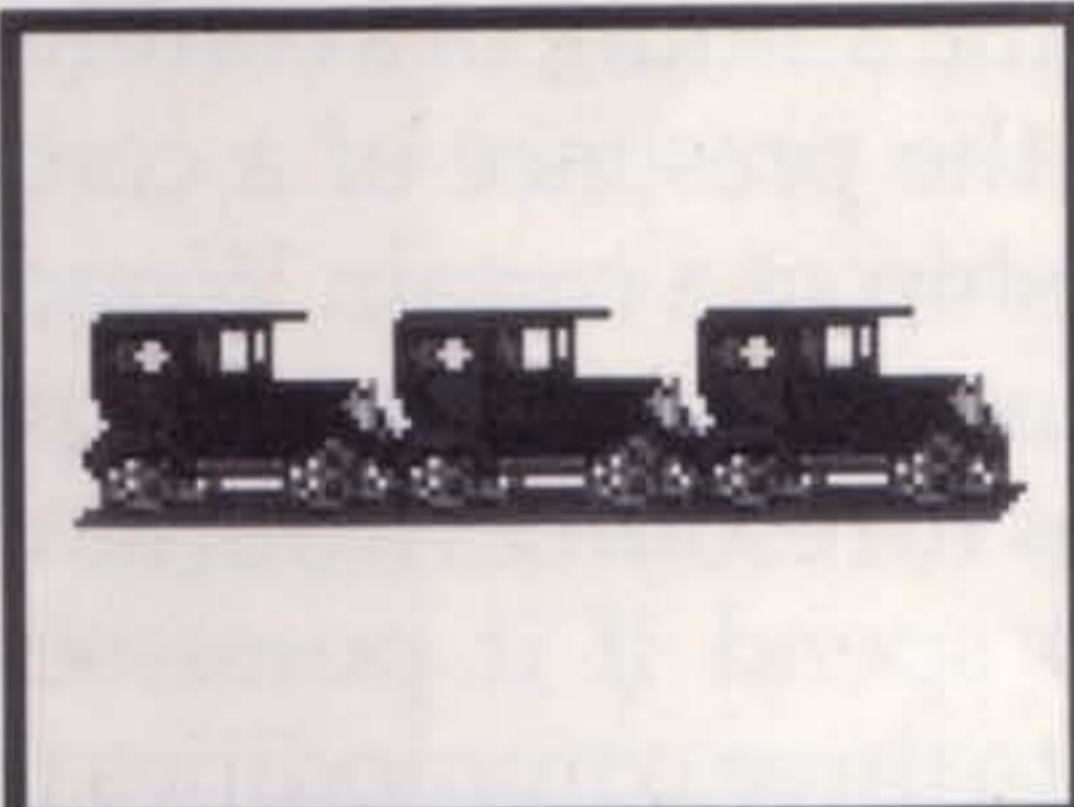

 Submarine Unit

 Mass Transit

Luxuries: These are shown as diamonds. For every two diamonds of luxuries produced, one content citizen becomes happy. Luxuries are most useful for making people happy, especially in very large cities that may have a large segment of unhappy people that need to be countered.

The amount of luxuries generated may be increased quickly by creating Entertainers, a type of Specialist discussed below. Luxuries may be increased by raising the luxury rate of trade brought in. Luxuries are best increased by increasing the amount of trade the city generates. The amount of luxuries brought in by trade may be increased by a Market place or Bank.

Tax Revenues: These are shown as gold coins and are used to pay maintenance costs for city improvements. Surplus taxes collected are added to the treasury and can be spent later. The amount of taxes collected from trade may be increased by Taxmen, another type of Specialist. The amount of taxes brought in by trade may be increased by a Marketplace or Bank.

Science: The knowledge that results from science research is shown as light bulbs. Each new technology that you direct your scientists to discover requires the investment of a certain amount of research. When enough light bulbs of research have been spent, the new advance is acquired by your civilization. The Library and University improvements plus some of the Wonders of the World increase the amount of research a city does. In addition, research may be increased by another type of Specialist, Scientists.

Corruption: Depending on your type of government and the city's distance from your palace, some trade may be lost as corruption. Corruption is marked by a modified trade symbol after a break in the trade line. (On the IBM, the trade symbol has a dark shadow.) The farther your city from the city containing your Palace (your capital) the more corruption and lost trade. Building a Courthouse improvement in the city reduces corruption.

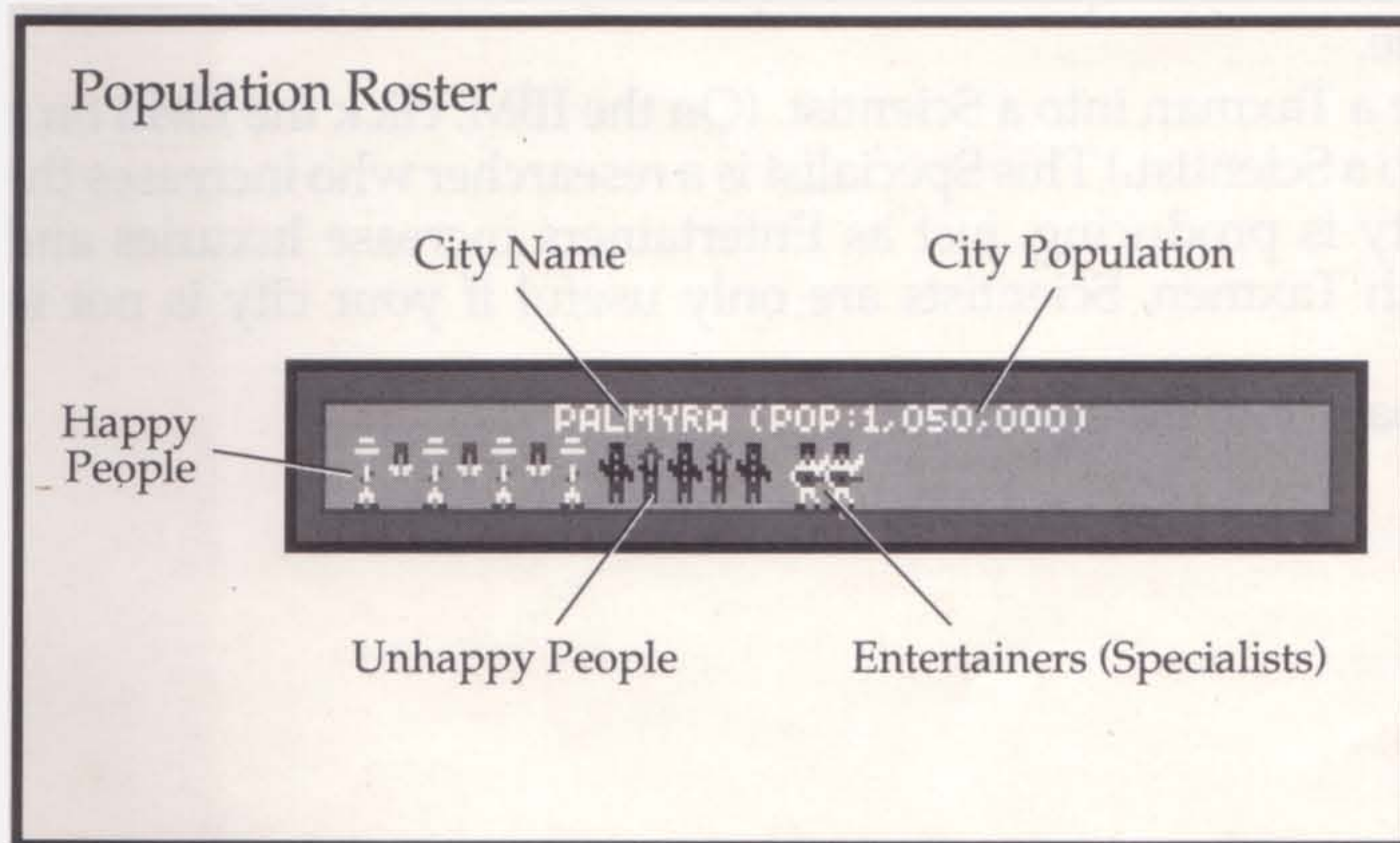

Population Roster

The population of your city is shown by a row of people in the population roster. Each person represents one population point. In addition to normal workers, the city may include three different types of Specialist, discussed below.

The normal people who work in city map areas are shown as either happy, content, or unhappy. You must manage your city's production and improvements so that at least a balance of happy and unhappy people is maintained. If the number of unhappy people exceeds the number of happy people (with content people being ignored in this case) your city goes into civil disorder (see page 66).

Specialists

Looking at the population roster is a quick way to see how the balance of happy and unhappy citizens stands. When a city is about to increase in size, it may be useful to adjust the work force so that the city is not thrown in to disorder by the increase. You can examine the population rosters of all of your cities at one time by consulting your Attitude Advisor from the Advisor menu.

People taken off the work force and removed from the city map become Specialists. These people no longer directly contribute to the food, resources, and trade the city generates. However, they may be useful in adjusting the amount of luxuries, taxes, and science the city generates. If your city is producing sufficient food, you may be able to afford Specialists and their special abilities. Specialists do require food like other people.

There are three types of Specialists. Entertainers are musicians and other artists who provide luxuries for your city and their presence makes more people happy. Taxmen are bureaucrats who make the city government, specifically tax collection, more efficient. Scientists are researchers who increase the city's contribution toward discovering new technology.

Entertainers: People removed from the work force immediately become Entertainers. Each Entertainer is the equivalent of two additional trade symbols added to that part of the city's trade brought in as luxuries. This additional trade is added before the effects of improvements such as Marketplaces and Banks are calculated. Creating Entertainers has the result of creating more luxuries and making more happy people.

Taxmen: You can change an Entertainer into a Taxman. (On the IBM, click the LMB on the Entertainer in the population roster. The Entertainer converts into a Taxman.) Each Taxman has a similar effect to that of an Entertainer, except that tax revenues are increased, not luxuries. When an Entertainer is converted, the luxury benefit stops working.

Note that increasing taxes is only helpful if the city remains out of civil disorder. Otherwise, no collection is made.

Scientists: You can change a Taxman into a Scientist. (On the IBM, click the LMB on a Taxman and he is converted into a Scientist.) This Specialist is a researcher who increases the amount of knowledge your city is producing, just as Entertainers increase luxuries and Taxmen increase taxes. As with Taxmen, Scientists are only useful if your city is not in civil disorder.

You can convert Taxmen back into Entertainers.

Mathematics
(Alphabet & Masonry)

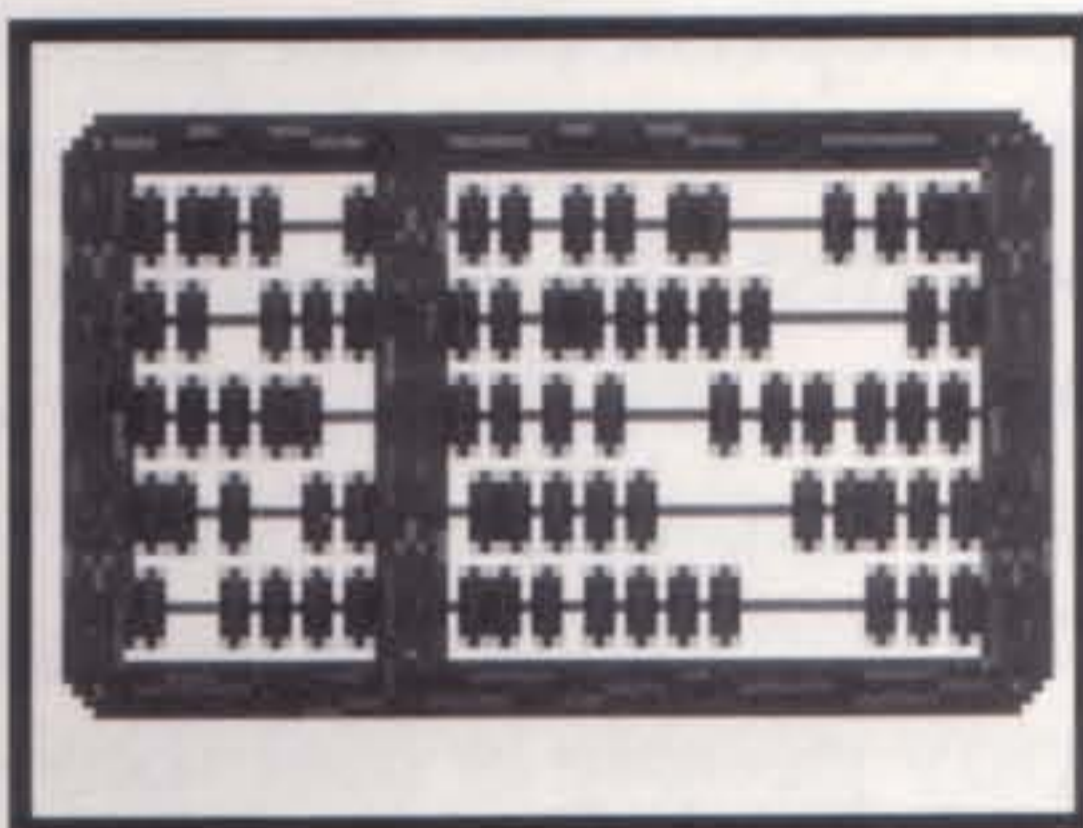

Catapult Unit

Food Storage Box

Into this box goes any surplus food generated by your city each turn. This is food to the right of the break in the food line, if one appears. This food is not needed to feed the city's population and the Settlers that it is supporting. Food put in the storage box is stored and accumulates each turn. When the box overflows, your city's population grows by one point and a new citizen is added to the population roster. The storage box is emptied and begins to fill again next turn.

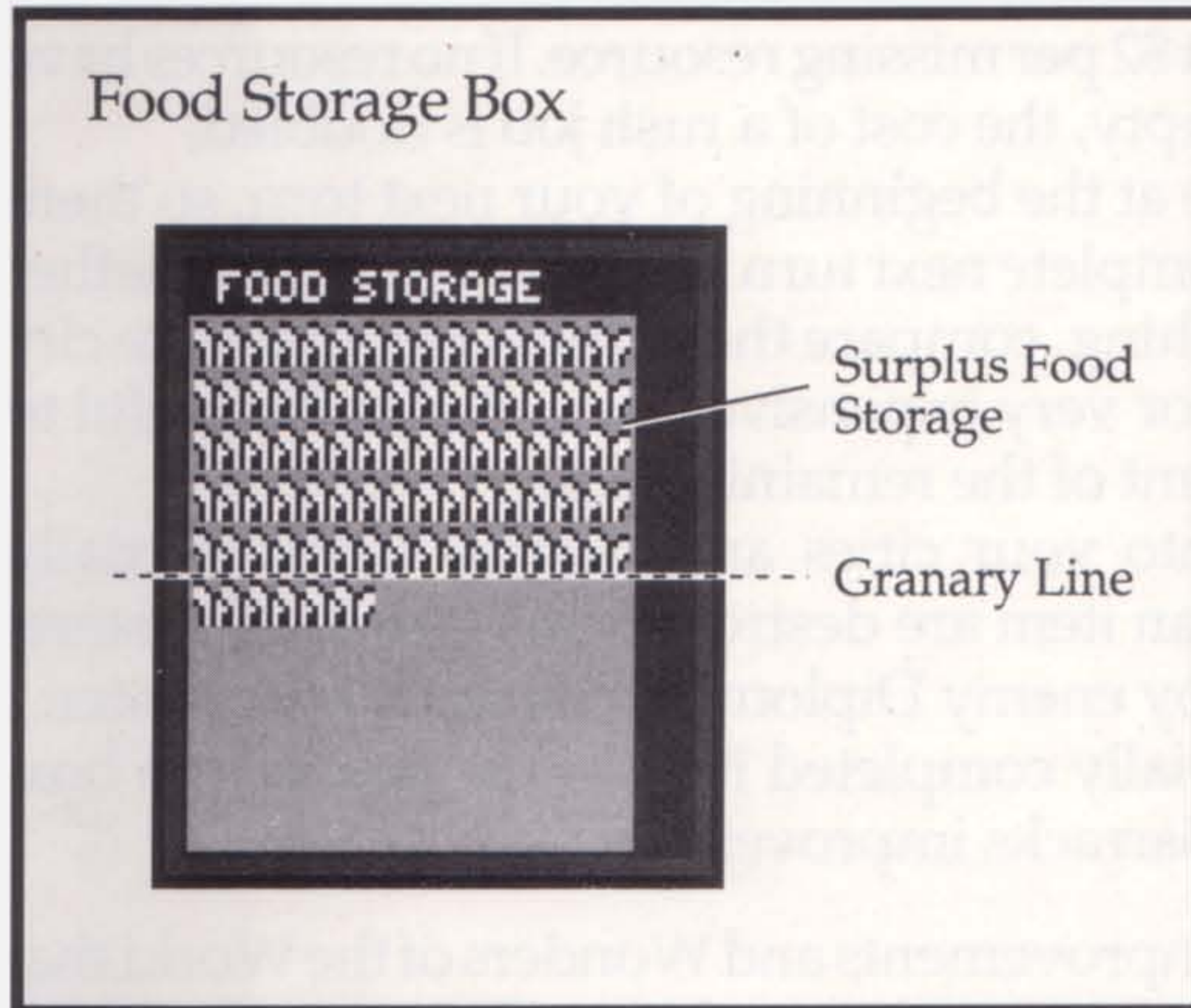

If one of your cities is not currently producing enough food to feed its population, the people don't starve so long as food is available for use in its storage box. Each turn, any food shortage is subtracted from food in the box. If the box is empty and the city still has a food shortfall, one point of population starves and disappears.

The Granary improvement has the effect of speeding population growth. When a city has a Granary, the storage box only half empties when it overflows and creates more people. The box empties only to the granary line. In addition, a Granary protects the city from starvation during a Famine disaster.

Production Box

Into this box go any surplus resources generated by your city each turn. Surplus resources are those not needed to maintain existing units and are shown to the right of the break in the resource line in the city resources window. Resources accumulate in the box until it fills, thereby completing the unit or improvement being built.

The item being built is noted by its icon, if it is a unit, or its name if it is an improvement or Wonder. The items available for building depend on the technology your civilization has achieved at the moment. The size of the production box grows or shrinks, depending on the number of resources required to build each item. You may change the item being built during any turn before it is completed. You may also speed the completion of an item by paying for a rush job.

Change Production: Use the Change button to open the menu of items that you can produce. (On the IBM, click the LMB on the button.) Then make your selection from the menu of choices that appears. The production box changes size to indicate the resource cost of your selection and the name or the icon of the new item appears at the top of the box.

If you are producing an item that is no longer available from the menu, that production continues even after the item is completed. However, if you open the production menu while producing an obsolete item, you must make a new choice as the old one disappears.

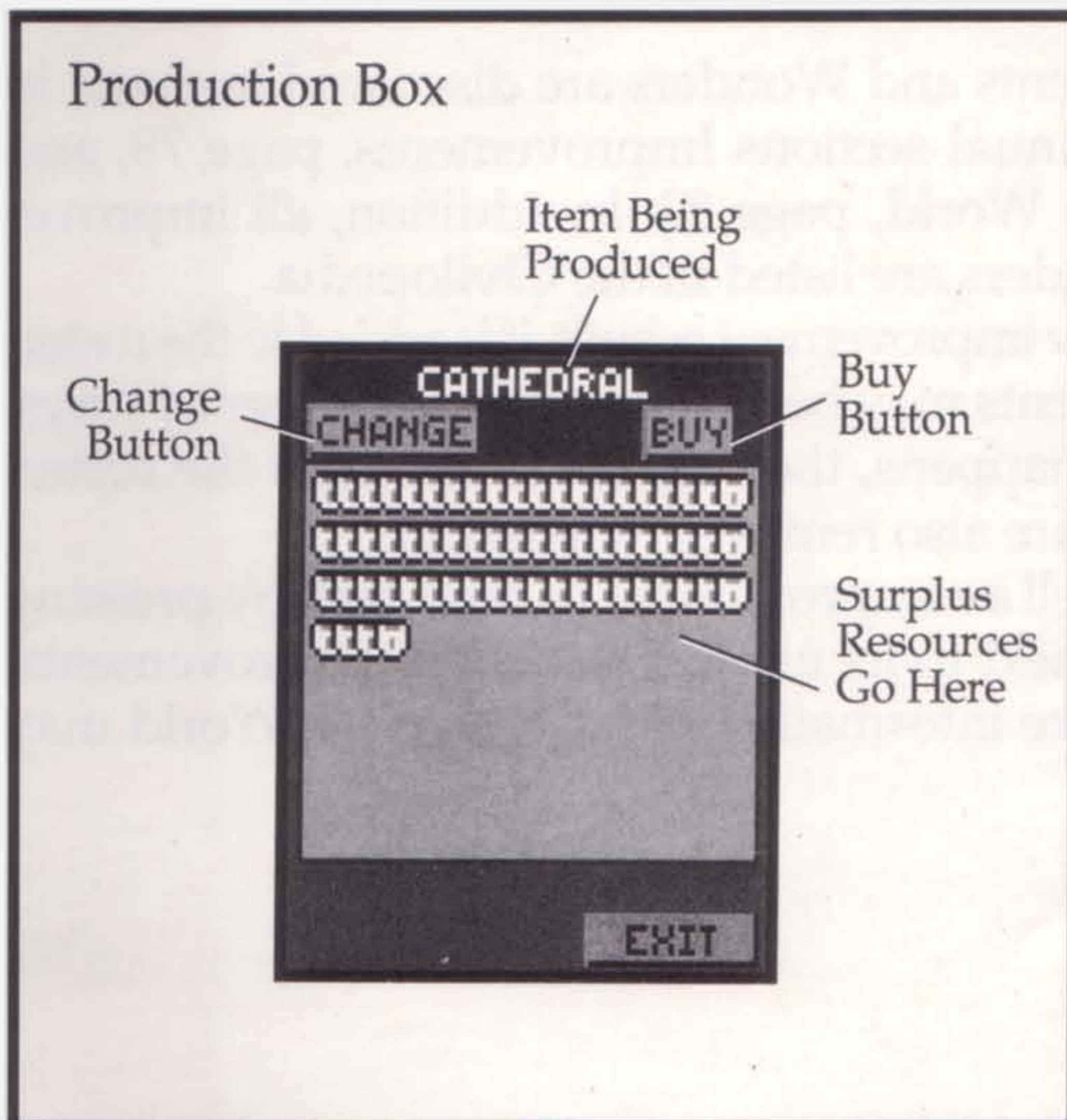

If you are building a Wonder and another civilization completes it before you can, you must change the production of your city. You are taken to your city's display in order to make the production change.

Rush Jobs: You may rush completion of a partially built item by paying to complete it immediately. To rush completion, use the Buy button at the top right of the box. (On the IBM, click the LMB on the button.) A menu appears showing how much money is required to finish the object by the end of the turn. Choose whether to rush the item or not. To speed the completion of an item in this manner costs at least \$2 per missing resource. If no resources have gone into an item, i.e., the production box is empty, the cost of a rush job is doubled.

Items completed by rush jobs are available at the beginning of your next turn, so there is no advantage for rushing items that would complete next turn anyway. To judge whether an item can be completed next turn without rushing, compare the surplus resources the city is generating to the number needed to finish. For very expensive items, it may be useful to consult your city status advisor for an exact count of the remaining cost.

Sabotage: Enemy Diplomats may slip into your cities and destroy items partially completed. All resources currently invested in an item are destroyed and production starts over. Your only protection from this is to destroy enemy Diplomats before they can enter.

Disaster: Pirate raids also destroy the partially completed item in the production box. The only defense against them is building the Barracks improvement.

In this part of the city display is a list of the improvements and Wonders of the World that this city has built and that still exist. Items are listed one to a line and for each there is the item's icon, its name and a sell button.

Improvements Roster

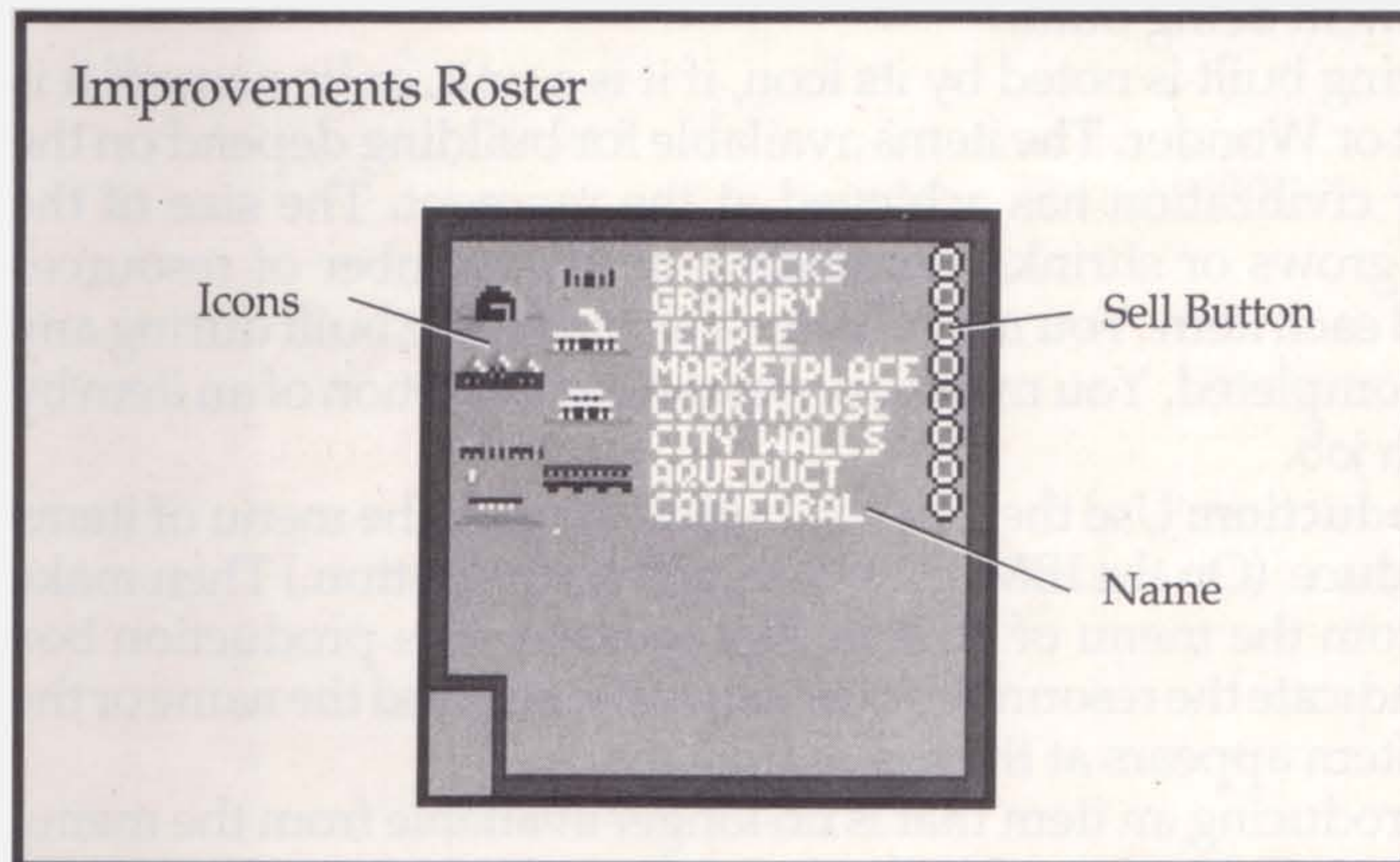

Improvements and Wonders are discussed in detail in the separate manual sections Improvements, page 78, and Wonders of the World, page 82. In addition, all improvements and Wonders are listed in the Civilopedia.

When a new improvement is built, it is added to the roster.

Improvements may be destroyed in a number of ways, and when this happens, they are removed from the roster. Improvements are also removed when sold.

You may sell an improvement to raise cash by pressing the sell button next to its name. See Selling Improvements, page 78, for more information. Wonders of the World may not be sold.

Home City Roster

The units now on the map anywhere in the world that are supported by this city are shown here. These units are normally ones that this city has built, but it is possible to reassign units to another city. When a unit built elsewhere is assigned to another city, it is added to the second city's home city roster and removed from the roster of the first city.

Also noted here are any resources or food required by the unit for maintenance. The amount of resource and food support units need depends on your civilization's type of government.

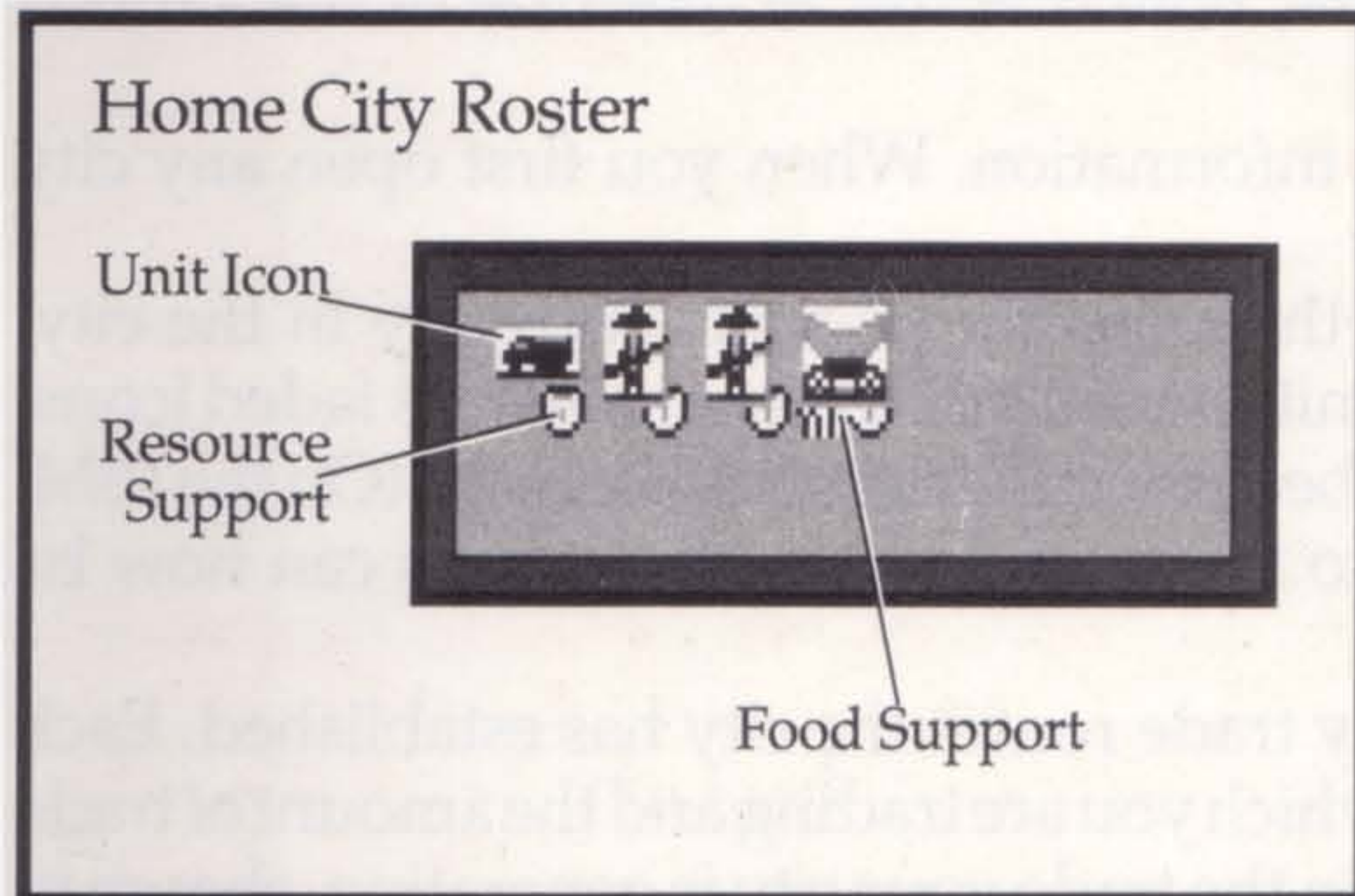

Units requiring resource maintenance are marked with a resource symbol below their icon. Resources needed for maintenance are unavailable for production and are shown to the left of any break in the resource line in the city resources window. If the city does not generate enough resources to maintain all of the units in the home city roster, units left unsupported are destroyed, beginning with the unit farthest from the city.

Settlers that require food support are marked with the number of food symbols they require.

Under two government types, the Republic and Democracy, each supported unit not in the home city causes one or more population point to become unhappy. These units are marked with special symbol to note that they are the source of some unhappiness.

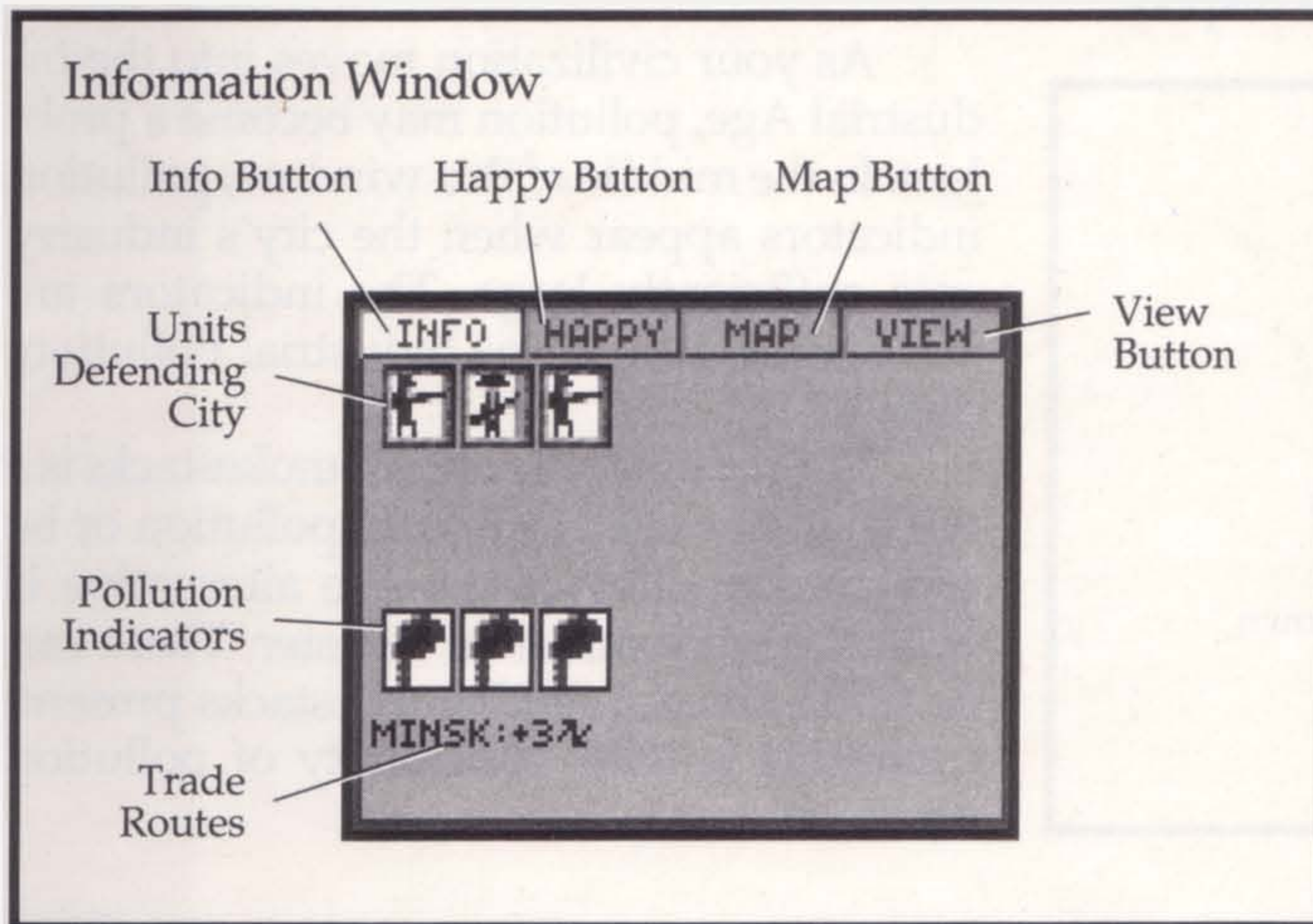

Information Window

Within this window various types of information can be reviewed or accessed. Here you can quickly see what military units are defending the city, what trade routes the city has established, whether the city is causing pollution, a small version of the world map, or a bird's-eye view of the city.

Across the top of the window are several buttons: Info, Happy, View, Map. Using these buttons you can call up the information you wish to see. (On the IBM, click the LMB on the button to call up information.) The button currently on is shown in a different color (white on the IBM).

Map: Pressing this button calls up a small version of the world map. The city you are in is marked for reference. (On the IBM, the city is a white dot.) Also marked on the map are the location of any cities with which you have established trade routes (shown as light green dots) and the location of units that make this their home city (light grey dots). The map may be useful for planning additional trade routes, assessing the danger of enemies, locating units you wish to disband, or deciding a sailing direction for newly launched ships.

View: This button opens the bird's-eye view of the city that is seen when a new improvement or Wonder is built. As time passes, note that the architecture of the various dwellings improves.

Info: This button calls up the most useful information. When you first open any city display, this button is automatically on.

Just below the row of buttons are shown the icons for all units currently in the city. Fortified units have a border around them and units on sentry duty are shown as faded icons. Fortified units or those on sentry duty may only be activated from this window. (On the IBM, click the LMB on the unit.) When you return to the map display, these units can now be given orders.

At the bottom of the window is a list of any trade routes the city has established. Each trade route is noted by the name of the city with which you are trading and the amount of trade generated. This trade is automatically included in the trade your city is generating, shown in the city resources window of the display.

As your civilization moves into the Industrial Age, pollution may become a problem. In the middle of this window, pollution indicators appear when the city's industry gets sufficiently large. The indicators are smokestack icons. (See Industrial Pollution, page 52.)

The presence of several smokestacks is a cue that you need to reduce pollution or be prepared to clean it up. The alternative is eventual environmental disaster. There can be up to one hundred smokestacks present, indicating a 100% probability of pollution each turn.

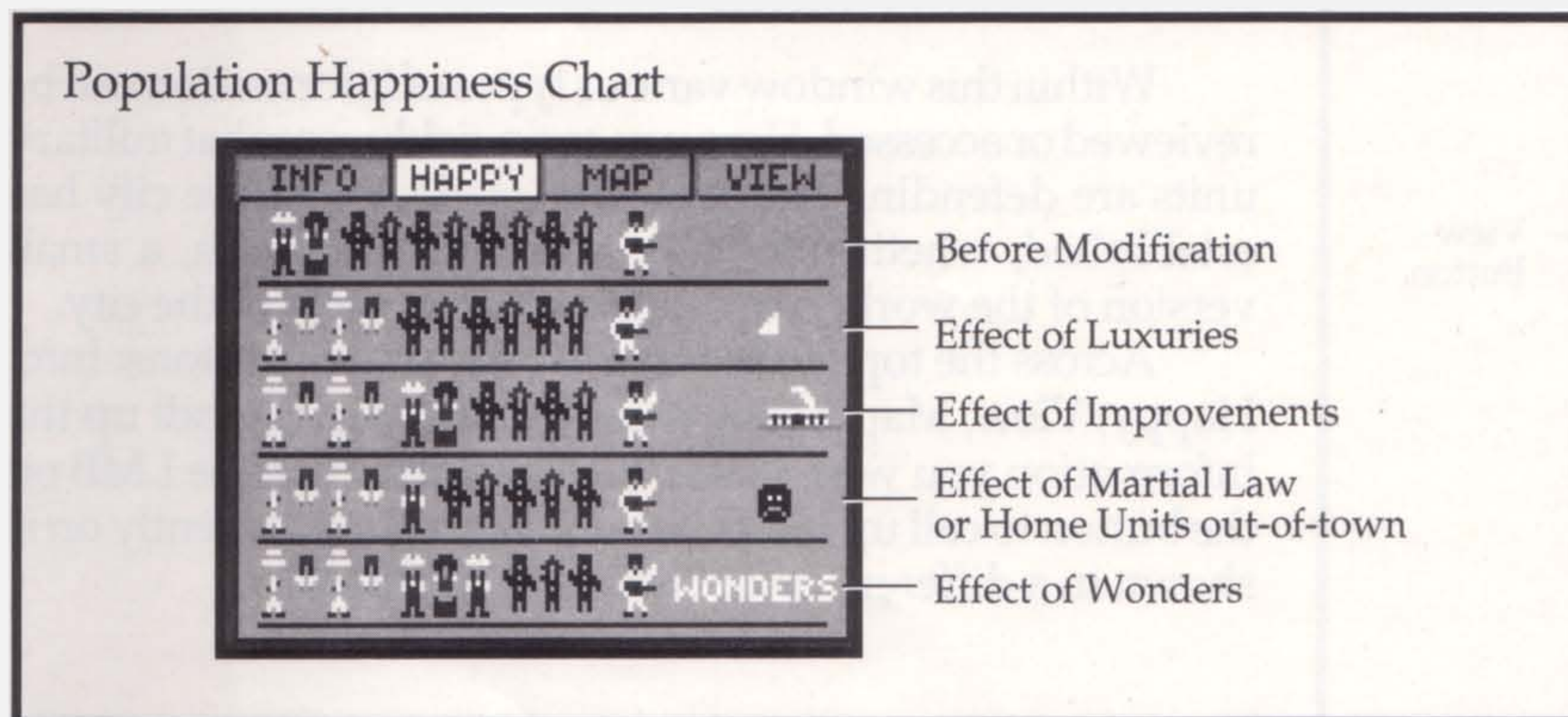

Happy: This button opens the Population Happiness Chart, which shows what factors are affecting the happiness of the city's population. All people in a city beyond a certain number are unhappy before any modifying influences are taken into account. At the Emperor level of difficulty, only the first two people are content; at King level, the first three; and so on down to Chieftain level, where the first six people are content.

When the city's population increases beyond these minimums, the new people are unhappy unless their condition is improved by a culture and standard of living that provides luxuries, religion, and entertainment; they are coerced into contentment by martial law; or the presence of Wonders of the World lifts their pride and spirits.

The top row of the chart shows the happiness of the population before taking into account any of the factors that improve happiness.

The second row shows the effects of the luxuries that are provided to the city, if any. Two units of luxuries make one content person happy or one unhappy person content. A contented person is made happy before another unhappy person is made content.

The third row shows the effects of Temples, Cathedrals, and Colosseums. These improvements have the effect of making unhappy people content.

The fourth row shows the effects of martial law and military service. Under all governments except the Republic and Democracy, each military unit in a city coerces one unhappy person into contentment. Any units imposing martial law are shown in this row. Under the Republic or Democracy, martial law does not work. Instead, each military unit not in its home city makes one or more persons unhappy. This is shown by "sad face" symbols in this row and under the units in the home city roster.

The fifth row shows the effects of any Wonders of the World, either in this city or elsewhere, that are influencing the population's happiness. For example, J. S. Bach's Cathedral decreases the number of unhappy people by two.

Specialists are content people, and are taken from the ranks of the content or happy population when created. The effect of the increased luxuries created by Entertainers is shown in row two.

The bottom row of the chart shows the cumulative effect of all factors on the happiness of the population. The status shown in this row is the same as that in the population roster at the top of the display.

Examining this chart is useful for understanding what is affecting the happiness of the city and perhaps indicating what else could be done if the city is out of balance. You may see where creating Entertainers, disbanding out of town units, bringing in more units, or building a new improvement can bring the city back into order.

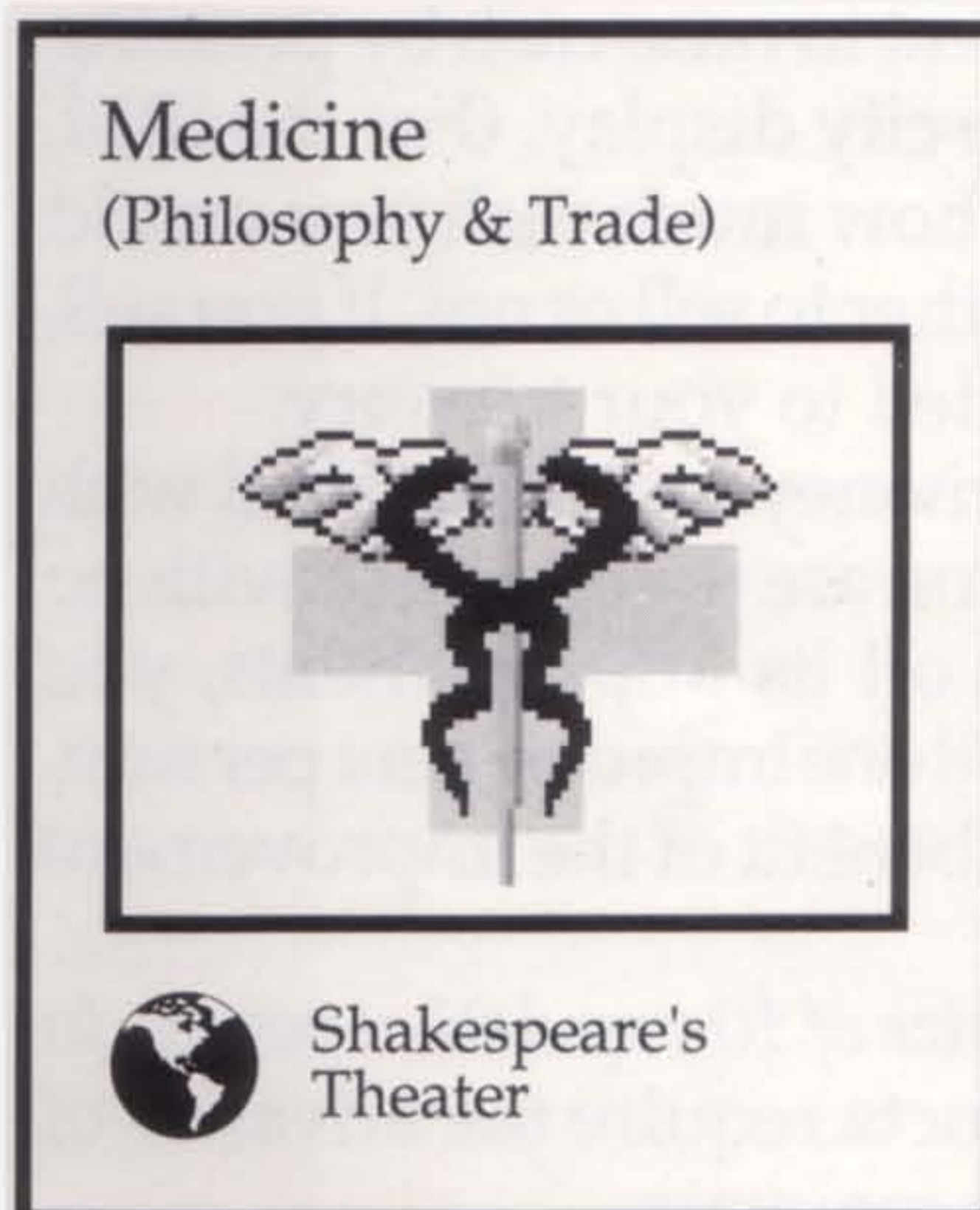

CITY IMPROVEMENTS

City improvements are the commercial, bureaucratic, educational, and public works infrastructure that make large and efficient cities possible. The potential size of a city is limited by inadequate provision of these facilities. The dense population of New York is made possible by the subway system. Los Angeles is located in a desert and brings much of its water from sources hundreds of miles away.

In *Civilization*, improvements are also critical to the growth and importance of cities. Each of the improvements available provides some service or otherwise makes the city work more efficiently.

When beginning a new civilization, you normally may only build one type of improvement, the Barracks. As your civilization acquires new technologies, more improvements become possible. Each city may only build one of each improvement. The improvements that your city possesses are listed in the improvements roster on the city display. Once built, improvements (but not Wonders) may be destroyed by sabotage, disaster, and capture, and may even be sold for cash.

Sabotage: Diplomats may enter a city and attempt industrial sabotage. This may result in the destruction of an existing improvement. The only defense against this type of attack is destroying the Diplomat before it can enter the city.

Disaster: Volcanos, Pirate Raids, Floods, Fires, and Earthquakes may destroy improvements in a city. There is no defense against Earthquakes, but Aqueducts prevent Fires, Temples prevent Volcanos, City Walls prevent Floods, and Barracks prevent Pirate Raids.

Capture: Some, all, or none of a city's improvements may be destroyed when it is captured by another civilization. When a city is completely destroyed, all improvements are destroyed as well.

Selling Improvements: You may sell an existing improvement to raise cash by pressing the sell button next to its name in the improvements roster of the city display. (For the IBM, click the LMB on the button.) An option menu appears showing how much cash you would receive for selling, which is \$1 per resource invested. Choose whether to sell or not. If you sell, the improvement disappears from the city and the money is added to your treasury.

Selling improvements may be useful when you are short of money and threatened with the random sale of an improvement. It may also be useful when you are under attack with no reasonable chance of defending or recovering a city. By selling off its improvements, you reduce its value to the enemy and salvage something. You may sell one improvement per turn.

An alphabetical list of improvements follows, including the benefit of the improvement and the technology that makes it possible.

Aqueduct: *Cities without an Aqueduct may not grow beyond a size of 10 population points. In addition, Aqueducts prevent the disasters of Fire and Plague.* Aqueducts require the advance of Construction, cost 120 resources to build, and cost \$2 per turn to maintain.

Metallurgy
(Gunpowder & University)



Cannon Unit

Bank: Banks increase the luxuries and taxes generated by a city by 50%. They require the advance of Banking and the city must already have a Marketplace improvement. The bonus from a Bank is added to that of an existing Marketplace and then applied. This bonus takes effect after all other considerations, including trade routes. Banks cost 120 resources to build and \$3 per turn to maintain.

Barracks: New units built in this city are already veterans, increasing their attack and defense factors by 50%. Barracks prevent the disaster of pirates. No technology is required to build Barracks. However, all existing Barracks become obsolete and disappear when you acquire the advances of Gunpowder and Combustion. Second generation Barracks cost \$1 per turn to maintain and third generation Barracks cost \$2 per turn to maintain.

Cathedral: A Cathedral makes four unhappy people content and is very useful for keeping a large city out of civil disorder. It requires the advance of Religion, costs 160 resources to build, and costs \$3 per turn to maintain. The effect of all Cathedrals in your cities is increased if you possess Michelangelo's Chapel, a medieval Wonder of the World.

City Walls: City Walls triple the strength of a defending unit, except when attacked by a Bomber or Artillery unit. This tripling occurs after considering the effect of terrain and veteran status. Cities defended by City Walls do not suffer population losses when a defending unit is destroyed. Walls also prevent the disaster of Flood. They require the advance of Masonry, cost 120 resources to build, and cost \$2 per turn to maintain.

Colosseum: The Colosseum is a large stadium for holding athletic contests and other events drawing crowds. Its presence makes 3 unhappy people content. It requires the advance of Construction, costs 100 resources to build, and costs \$4 per turn to maintain.

Courthouse: This improvement reduces corruption in a city by 50%. It requires the advance of the Code of Laws, costs 80 resources to build, and costs \$1 per turn to maintain.

Factory: A Factory increases the amount of resources generated by a city by 50%. A Factory becomes obsolete and stops working if a Manufacturing Plant is built in the same city. A Factory requires the advance of Industrialization, costs 200 resources to build, and costs \$4 per turn to maintain. The effect of a Factory may be increased by the presence of a Hydro Plant, a Nuclear Plant, or a Power Plant. It may also be increased by the Hoover Dam, a modern Wonder of the World.

Granary: Cities possessing a Granary use up only 50% of their stored food to create new population. The storage box only half empties. In addition, the Granary prevents a Famine disaster from destroying population. The Granary requires the advance of Pottery, costs 60 resources to build, and costs \$1 per turn to maintain.

Monarchy
(Ceremonial Burial &
Code of Laws)



Hydro Plant: *The production bonus for a Factory or Manufacturing Plant is doubled if the city has a Hydro Plant. In addition, a Hydro Plant reduces the probability of pollution. A Hydro Plant may only be built by a city on or near a River, Hills, or Mountains. It requires the advance of Electronics, costs 240 resources to build, and costs \$4 per turn to maintain.*

Library: *A Library increases the knowledge production of a city by 50%. It requires the advance of Writing, costs 80 resources to build, and costs \$1 to maintain. The effect of all Libraries in your cities is increased if you possess Isaac Newton's College, a medieval Wonder of the World.*

Manufacturing Plant: *This improvement increases the resources generated by a city by 100%. It requires the advance of Robotics, costs 320 resources to build, and costs \$6 to maintain. Its presence makes an already existing Factory obsolete and the Factory ceases to work. The effect of a Manufacturing Plant may be increased by the presence of the Hydro Plant, the Nuclear Plant, the Power Plant, or the Hoover Dam.*

Marketplace: *A marketplace increases tax revenue and luxuries by 50%. The Marketplace becomes available with the advance of Currency, costs 80 resources to build, and costs \$1 per turn to maintain.*

Mass Transit: *In cities with Mass Transit, the population has no effect on pollution. Otherwise, when a civilization has acquired the Automobile advance, the population of its cities increases the probability of pollution. Mass Transit requires the advance of Mass Production, costs 160 resources to build, and costs \$4 to maintain.*

Nuclear Plant: *Like other types of power plants, the Nuclear Plant increases the production of a Factory or Manufacturing Plant by another 50%. A Nuclear Plant also reduces the day-to-day probability of pollution. However, a Nuclear Plant in a city suffering civil disorder risks a nuclear meltdown (see page 54). The Nuclear Plant requires the advance of Nuclear Power, costs 160 resources to build, and costs \$2 per turn to maintain.*

Palace: *This is the administrative and governmental center of your civilization. The farther any city is from the city containing the Palace, the more corruption is likely. You may build a new Palace in another city, but this causes the retirement of the first Palace and relocation of the government. If your Palace is destroyed, a new one may be built in any existing city. The Palace requires the advance of Masonry and costs 200 resources to build. Your Palace costs nothing to maintain.*

Power Plant: *This source of industrial power increases the resources generated by Factories and Manufacturing Plants by an additional 50%. However, it increases the probability of pollution significantly. The Power Plant requires the advance of Refining, costs 160 resources to build, and costs \$4 per turn to maintain.*

Recycling Center: *The recycling center reduces the probability of pollution by two-thirds. It requires the advance of Recycling, costs 200 resources to build, and costs \$2 to maintain.*

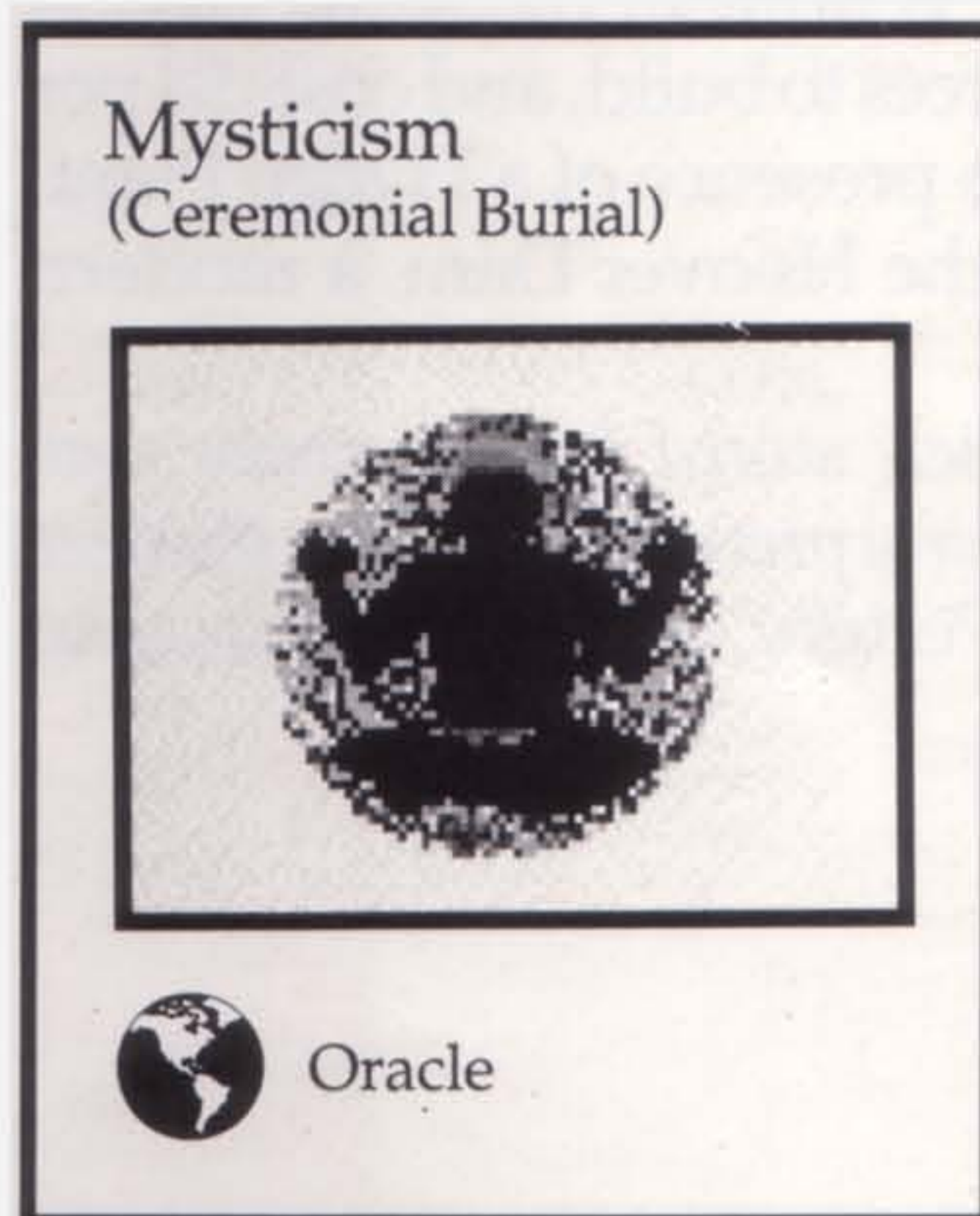

SDI Defense: *The SDI (Strategic Defense Initiative) Defense protects the city from Nuclear units. Attacks by these weapons have no effect. This improvement becomes available with the Superconductor advance. The SDI Defense costs 200 resources to build and \$4 to maintain.*

Temple: *The Temple improvement becomes available with the Ceremonial Burial advance. Its presence makes one unhappy person content. With the additional advance of Mysticism, another person is made content by a Temple, for a total of two. A Temple prevents the Volcano disaster. Temples cost 40 resources to build and \$1 to maintain. The effect of a Temple may be doubled if your civilization possesses the Oracle, an ancient Wonder of the World.*

University: *The presence of a University increases the knowledge generated by a city by 50%. A University may only be built in a city that already possesses a Library. The University bonus is added to the bonus from an existing Library. Together they double the knowledge generated. Universities become available with the advance of the University. They cost 160 resources to build and \$3 to maintain. The effect of all Universities in your cities is increased if you possess Isaac Newton's College, a medieval Wonder of the World.*

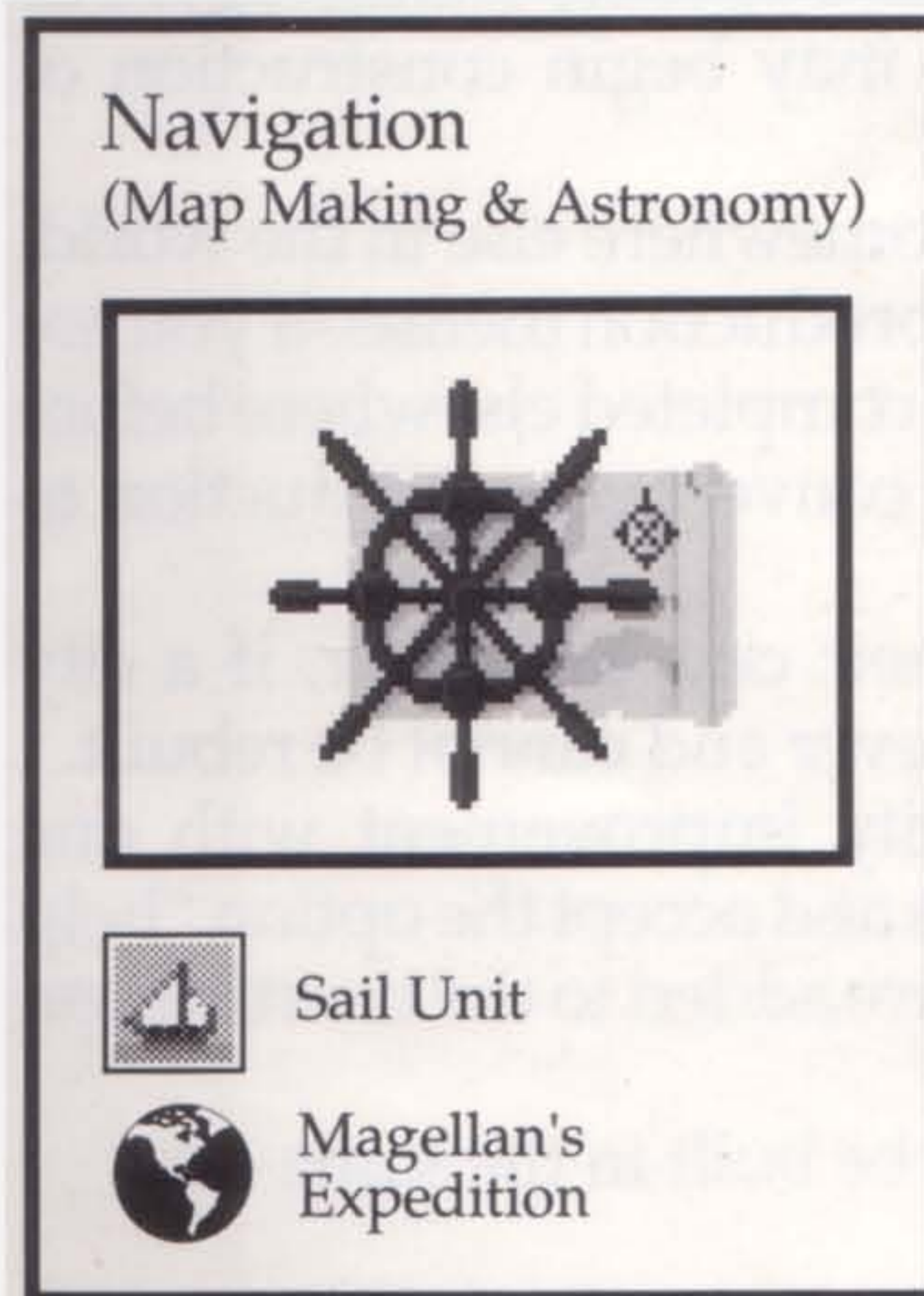

WONDERS OF THE WORLD

As your civilization progresses through the years, certain advances make possible the building of Wonders of the World. There are 21 Wonders, 7 each for the three great epochs of civilization: Antiquity, the Middle Ages (including the Renaissance), and the Industrial Age (present and future). These Wonders are the extraordinary monuments of a civilization, bringing everlasting glory and other benefits to their owners.

A Wonder is a dramatic, awe-inspiring accomplishment. It is typically a great achievement of engineering, science, or the arts, representing a milepost in the history of humankind. Each Wonder is unique, existing only in the city where it is constructed.

In addition to the glory attached to owning a Wonder, each one has a specific, unique benefit. The people of your civilization are able to perform amazing feats, inspired by their pride in the possession of Wonders. For example, if your civilization possesses the Lighthouse, your ship units are able to move one additional map square per turn.

The benefits of some Wonders apply only to the civilization that possesses them. If a Wonder you build is lost when one of your cities is captured, the powers of the Wonder then apply to the conquering civilization. The same holds true if you capture a Wonder.

However, the benefits of the ancient Wonders and most of the Wonders of the Middle Ages may not stand for all time. Objects and accomplishments that awed the ancients may not similarly inspire the people of the Industrial Age. The achievement of later advances may end the benefits of older Wonders, regardless of whether your civilization or another makes the cancelling advance.

Construction

Each Wonder may be built once your civilization achieves a specific technology. For example, when your civilization acquires Map Making, you may begin construction of the Lighthouse.

You may only build a Wonder if it does not already exist somewhere else in the world. If it exists in another city, it does not appear as an option in your production menus. If you are building a Wonder in one of your cities and the same Wonder is completed elsewhere before you finish, you cannot complete your construction. You must convert your production to something else.

Wonders are not destroyed when an enemy occupies their city. However, if a city possessing a Wonder is destroyed, that Wonder is lost forever and cannot be rebuilt.

Wonders are built in the same manner as any other city improvement with one exception. You may move a Caravan into the city of construction and accept the option "help build Wonder." All of the resources that went into the Caravan are added to the construction of the Wonder.

Wonders may be built in any city and more than one may be built in the same city.

Effects

Each Wonder has specific and general benefits. An example of a specific benefit is increased movement of your ships when you possess the Lighthouse.

General benefits are the glory that accrues to your civilization for possessing the Wonder, even after new technology makes it obsolete. Each Wonder that your civilization possesses adds to your civilization score. The presence of Wonders are significant when the top 5 cities in the world are measured. The presence of Wonders also influences the historians, such as Gibbon, who periodically rate the world's civilizations. Finally, Wonders also influence the decision of the people to improve your palace.

Antiquity

Colossus: The Colossus is a great bronze statue bestriding the gates or harbor mouth of the city. This amazing statue draws tourists from around the world, greatly increasing the trade of the area.

Trade is +1 in every city map square that is already generating some trade. The effect on tourism stops working after development of Electricity and the trade benefit is thereafter lost. The Colossus requires the advance of Bronze Working and takes 200 resources to build.

Great Library: Begun as a hobby by a local ruler, the Great Library is an obsession for the city. Its agents scour the world for books and manuscripts, making the Great Library the largest knowledge repository in existence.

The Great Library gives you any technology that two other civilizations have acquired. However, it stops working after development of the University. It requires the advance of Literacy and takes 300 resources to build.

Great Wall: The Great Wall was built not so much to keep invaders out, but to retard their escape with any loot. The effect is to deter the aggressiveness of neighbors.

When you possess the Great Wall, other civilizations always offer peace during negotiations. However, the effect of the Great Wall ceases after development of Gunpowder. It requires the Masonry advance and takes 300 resources to build.

Hanging Gardens: The magnificent Hanging Gardens are a great marriage of engineering and beauty. Architecturally brilliant layered tiers of gardens are ingeniously supplied with water. Any visitor is overwhelmed by the grace of this man-made garden of paradise.

Possessing this beautiful monument brings great pleasure to the people of your civilization and results in +1 happy citizen in each of your cities. This magical effect of the Hanging Gardens expires with the development of Invention because, thereafter, the gadgetry of the garden design becomes cheaply available to everyone.

Knowledge of the Hanging Gardens is acquired with the advance of Pottery, and the Wonder takes 300 resources to build.

Lighthouse: The construction of this immense Lighthouse not only creates the greatest navigational aid of antiquity, but triggers a birth of seafaring skills and traditions. The result is great achievements by your ships and captains.

Nuclear Fission
(Atomic Theory &
Mass Production)



Manhattan Project

The Middle Ages

Possession of the Lighthouse increases sea movement rates by 1 square for all of your ships. However, the effect of the Lighthouse ceases working after development of Magnetism, a new navigational aid that puts competent sailing within the grasp of anyone. The Lighthouse requires the advance of Map Making and it takes 200 resources to build.

Oracle: Building the Oracle gives the beliefs of your civilization a unifying central dogma that increases its effect on the people. The auguries of the Oracle are transmitted through the local Temples, exerting significant control over their lives.

The Oracle becomes available with the advance of Mysticism and doubles the effect of your Temples in making unhappy people content. It stops working after the development of Religion, which appeals more widely to the growing literate, intelligent citizenry. The Oracle takes 300 resources to build.

Pyramids: The Pyramids are the greatest and oldest of the ancient Wonders. Their construction requires great government control of the entire nation to make possible the effort of their construction.

A civilization that possesses the Pyramids may change government type without going through a period of Anarchy. In addition, that civilization may select any type of new government, not just those for which it has made the correct advance. For example, the possessing nation may become a Democracy long before it acquires the technology of Democracy.

The Pyramids require the advancement of Masonry and take 300 resources to build. However, the effects of the Pyramids expire after the advance of Communism is achieved.

Copernicus's Observatory: Working alone on cold nights in the tower of his cathedral, this Polish priest re-established that the Sun was the center of the Solar System, not the Earth. This fact had been recognized by ancient astronomers but lost in the Dark Ages, buried under superstition and religious dogma. Copernicus's findings were controversial but proven true, and were an important step in the rebirth of Western science.

Building Copernicus's Observatory doubles knowledge production in the city, after all adjustments for Libraries, Universities, and Scientists. However, this benefit stops working after development of the Automobile. The advance of Astronomy makes the Observatory possible. It costs 300 resources to build.

Darwin's Voyage: Partially from the research accomplished on his scientific voyage aboard the *Beagle* to the Galapagos Islands, Charles Darwin developed the theory of evolution that was published in his masterwork, *The Origin of Species*. Darwin's arguments, and those of his contemporary, Alfred Russell Wallace, were so convincing that they were only disputed on philosophical grounds, mainly by religious fundamentalists. The theory of organic evolution was the foundation of all following research in biology.

The civilization that builds Darwin's Voyage immediately acquires two civilization advances. The advance of Railroads makes Darwin's Voyage possible. The Voyage costs 300 resources.

Isaac Newton's College: Considered by many to be the greatest scientist of all time, Newton developed theories of universal gravitation that explained both the motion of heavenly bodies and the falling of bodies to Earth. He also wrote important works on calculus, optics, the spectrum of light, fluid mechanics, the motion of comets, and the motion of tides, and built the first reflecting telescope. For 32 years he was a professor of mathematics at Cambridge University.

Possessing Newton's College increases the knowledge benefit of all your Libraries and Universities. It may be built once you have acquired the Theory of Gravity, but stops working after development of Nuclear Fission. The College requires 400 resources to build.

J. S. Bach's Cathedral: Johann Sebastian Bach was one of the great composers of the Western world. Born into a family of distinguished musicians, he was noted as a virtuoso performer during his life, but has become much more revered since his passing for the genius of his music. The majority of his compositions were written while serving the church, and most pieces were written for the organ and dedicated to the glory of his God.

Possessing Bach's Cathedral decreases unhappy citizens on the same continent by 2 per city. The Cathedral may be built following the advance of Religion and costs 400 resources. The power of Bach's music does not expire.

Magellan's Expedition: Ferdinand Magellan, a Portugese navigator, led the first expedition that circumnavigated the globe. Sponsored by Charles I of Spain, he was searching for a westward route to the spice islands of the Moluccas. Along the way he discovered the straits at Cape Horn that bear his name. Unfortunately, he died in the Philippines fighting natives. Only one of his five original ships and few of his men reached home, but the expedition proved that the Earth was round.

Possessing Magellan's Expedition increases sea movement rates by 1 square for all of your ships. The expedition becomes possible after the advance of Navigation and never expires. It costs 400 resources to build.

Michelangelo's Chapel: Michelangelo Buonarroti was perhaps the greatest of the Renaissance sculptors and painters. Working for the church in Rome and the Medici family in Florence, he is best known for his sculpture of David and the painting of the Sistine Chapel. He is renowned for the beauty of his work and the influence it had on succeeding generations.

You may build the Chapel after achieving the advance of Religion. Possessing it increases the benefits of Cathedrals throughout your civilization until the advance of Communism diminishes the strength of Religion. The Chapel takes 300 resources to build.

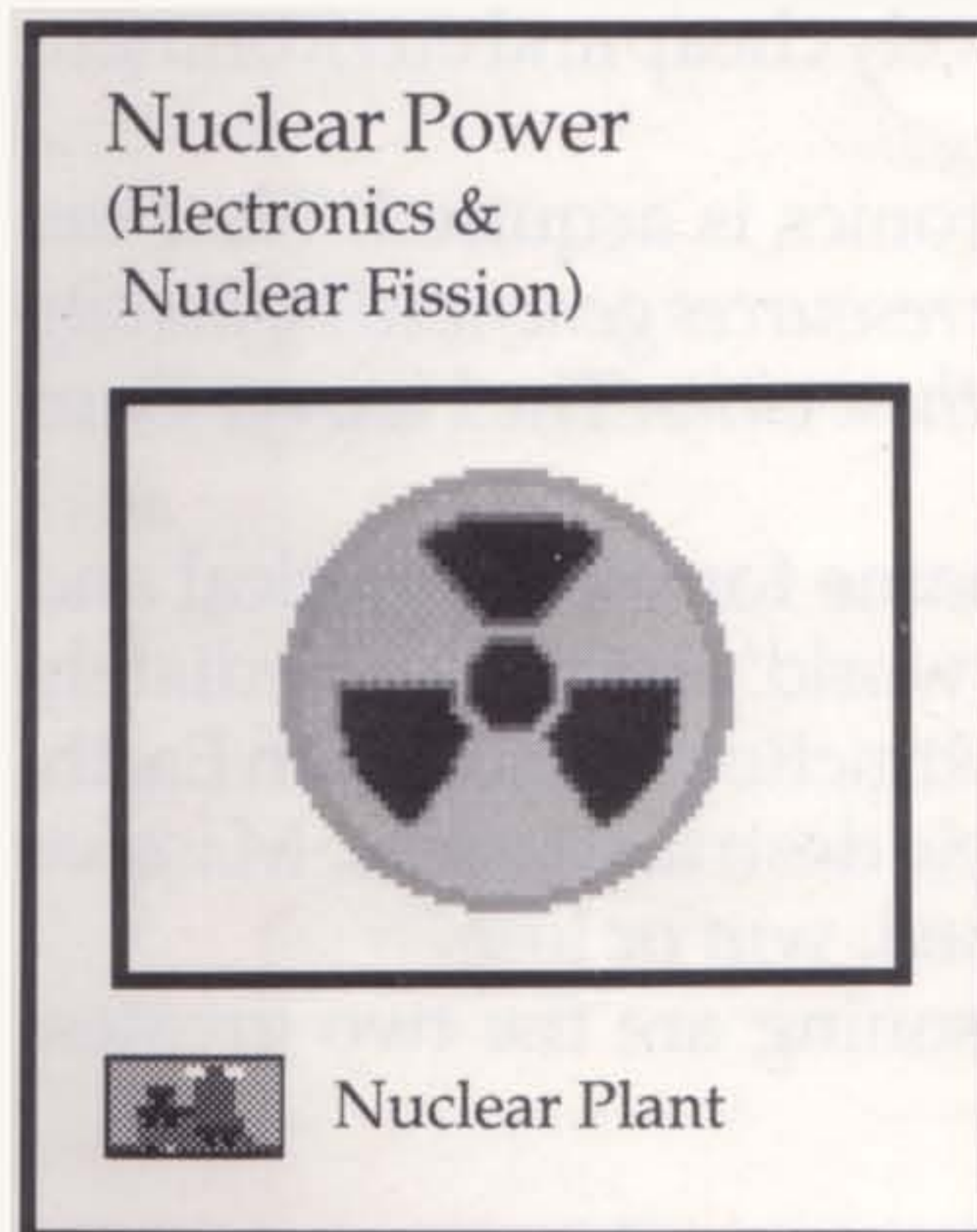

Industrial Age

Shakespeare's Theatre: William Shakespeare, an English dramatist and poet, is considered the greatest of all playwrights. Little is known of his life and he seems not to have become rich or famous in his own day. But not long after his death his fame began to grow and his influence on the English language has increased with the renown of his plays, which are still performed regularly around the globe.

The Theatre may be built after achieving the advance of Medicine. *Thereafter, all unhappy people in the city are content, until the advance of Electronics makes the Theatre obsolete.* It costs 400 resources to build.

Apollo Program: The culmination of the space race of the 1960s, the Apollo Program put several manned expeditions onto the Moon. Quickly overcoming many difficulties and dangers, the Apollo Program was one of the great technological achievements of the age. Its success promises that humankind may not be restricted just to Earth, but may eventually expand into space.

The Apollo Program may be built after achieving the advance of Space Flight. *It allows construction of space ships by any civilization having the technology to build parts.* The Apollo Program costs 600 resources to build.

Cure for Cancer: Of the diseases that continue to plague humankind, cancer remains one of the most feared and deadly. Despite huge efforts to find a cure for this malady, it continues to reap its toll each year. The developing science of genetic engineering offers new hope for a cure.

After the development of the advance of Genetic Engineering, you may work on the Cure for Cancer. *Possessing the Cure creates +1 happy citizen in all cities of your civilization.* The Cure for Cancer costs 600 resources.

Hoover Dam: Huge hydroelectric power sources were first developed in the United States during the 1930s and have since been built throughout the world. Converting the kinetic energy of falling water into electric power has proven to be a relatively cheap and environmentally sound method of generating electricity.

The Hoover Dam may be built after the advance of Electronics is acquired. *The Dam provides electric power to all cities on the same continent, increasing the resources generated by the city by 50%. In addition, the Dam reduces the probability of pollution from these cities.* The Hoover Dam costs 600 resources to build.

Manhattan Project: The Manhattan Project was the codename for the theoretical and practical development of atomic weapons. Once completed, the world's future immediately was in doubt because the weapons it made possible threatened extinction for all life on Earth. But these weapons also offered an umbrella of peace due to their destructiveness. Massive global war became obsolete because all participants were doomed, win or lose.

Now, surviving the Nuclear Age and environmental poisoning are the two greatest challenges of industrial civilization.

Philosophy
(Mysticism & Literacy)



Once any civilization completes the Manhattan Project, all civilizations in the world may begin building nuclear weapons, if they have the proper technology. The Manhattan Project itself may be built once the advance of Nuclear Fission has been achieved. The Project costs 600 resources to build.

SETI Program: The search for extra-terrestrial intelligence is a research effort set up to find an answer for one of humankind's most nagging questions: Are we the only intelligent life in the universe? Being the first civilization to contact other intelligent life brings great glory and perhaps technological advantages.

The SETI Program may be built when your civilization acquires the advance of Computers. Thereafter, the knowledge generated by your cities is increased by 50%, unless the Program is destroyed or captured by a rival. The SETI Program costs 600 resources to complete.

Women's Suffrage: A phenomena of the cultural, philosophical, and social changes that followed the Industrial Revolution has been a steadily increasing respect for the rights and abilities of women. Women demanded and won the franchise of the vote, first in Western Democracies, after demonstrating their ability to perform well almost any job while the men were off to war. This symbolic freeing from historic social hierarchies has led to increasing practical freedom, at least in the West.

Women's Suffrage becomes available after the advance of Mass Production. Under a Republic or Democracy, units away from their home city create one less unhappy citizen than normal for a civilization that possesses Women's Suffrage. It costs 600 resources to achieve.

United Nations: The United Nations is an international organization that meets to solve international problems through diplomacy. Its goal is world peace and security. It offers a forum for debate and also works to aid the economic and technical development of poorer nations.

Building the United Nations is a great achievement by a civilization. It is available after the advance of Communism. During negotiations with other civilizations, they always offer to make peace with you. This allows at least a temporary resolution to all wars you are engaged in. The United Nations costs 600 resources to build.

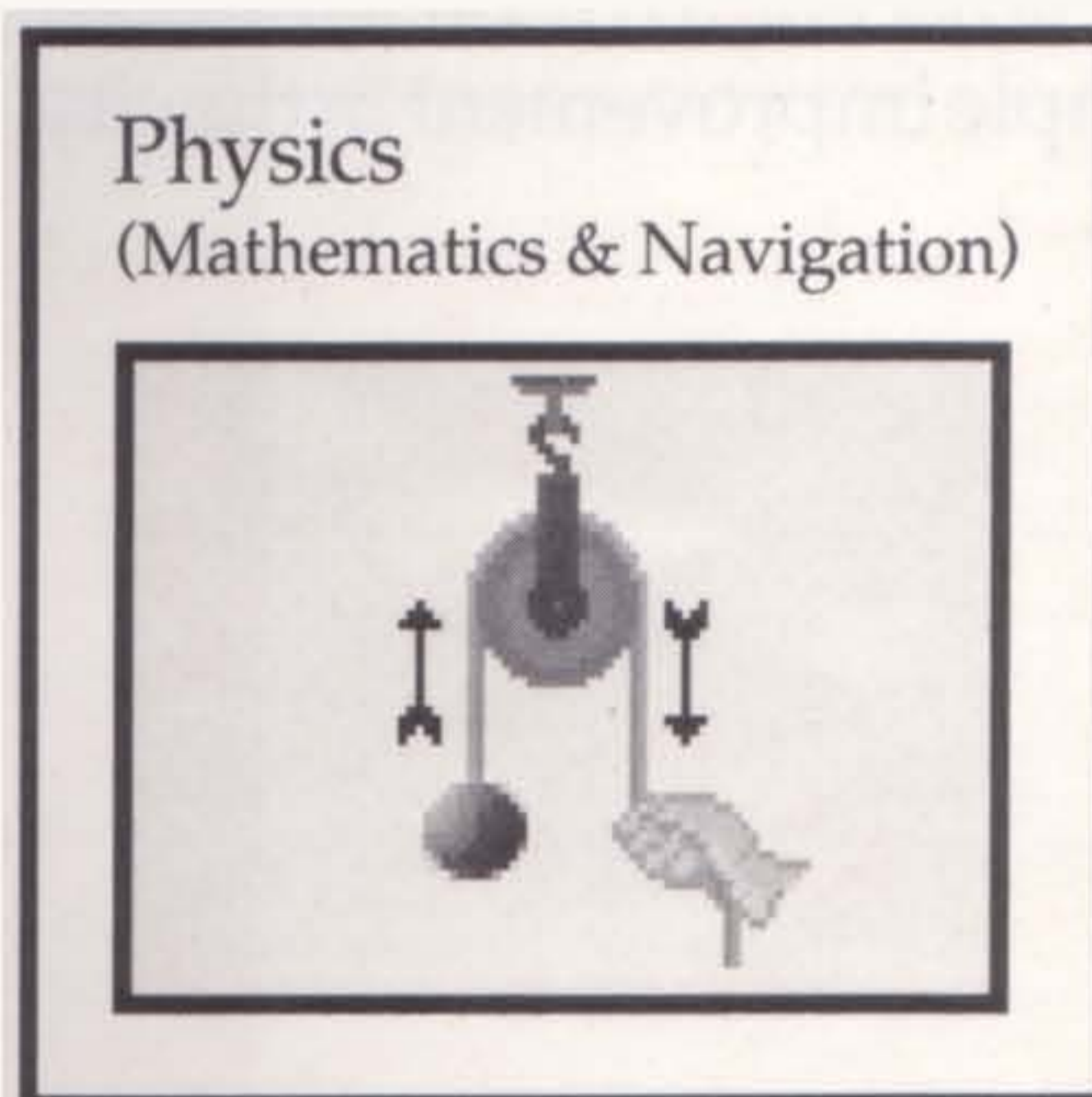

DISASTERS

Each game turn there is a chance that a disaster of some sort may strike one of your cities. A disaster may result in loss of population, destruction of a city improvement, or disruption of production. Some disasters may be prevented if your civilization has acquired certain advances or if the city has built a certain improvement. In these cases, the disaster does not occur or has no effect.

The possible disasters are described below. For each there is an explanation of why it occurs (if a reason exists), the effect on your city when it strikes, and what measures can prevent it, if any.

Earthquake: Earthquakes may strike any city that is built adjacent to Hills terrain. There is nothing that you can build or learn to prevent this disaster. An earthquake destroys one city improvement.

Famine: Famine strikes randomly. It can be prevented by building a Granary improvement. If it strikes a city with no Granary, all food in the food storage box is lost and the city's population is reduced.

Fire: Fire can hit any city at any time. It can be prevented by building an Aqueduct improvement. Fire destroys one city improvement.

Flood: Flood can strike any city built next to or on a River square. It can be prevented by building a City Walls improvement. Flood reduces city population.

Piracy: Pirate raids may strike any city built adjacent to an Ocean square. Pirates can be prevented by building a Barracks improvement. Pirates remove all food from the food storage box and destroy whatever is being built in the production box. All resources spent so far in production are lost.

Plague: Plague may strike any city at any time. It can be prevented by acquiring the advance of Medicine or by building an Aqueduct improvement. Plague reduces the city's population.

Volcano: A volcano may erupt and damage any city built adjacent to or on Mountain terrain. The effects of a volcano may be negated by building a Temple improvement in the city. Volcanic eruptions reduce the city's population unless negated.

Plastics
(Refining & Space Flight)

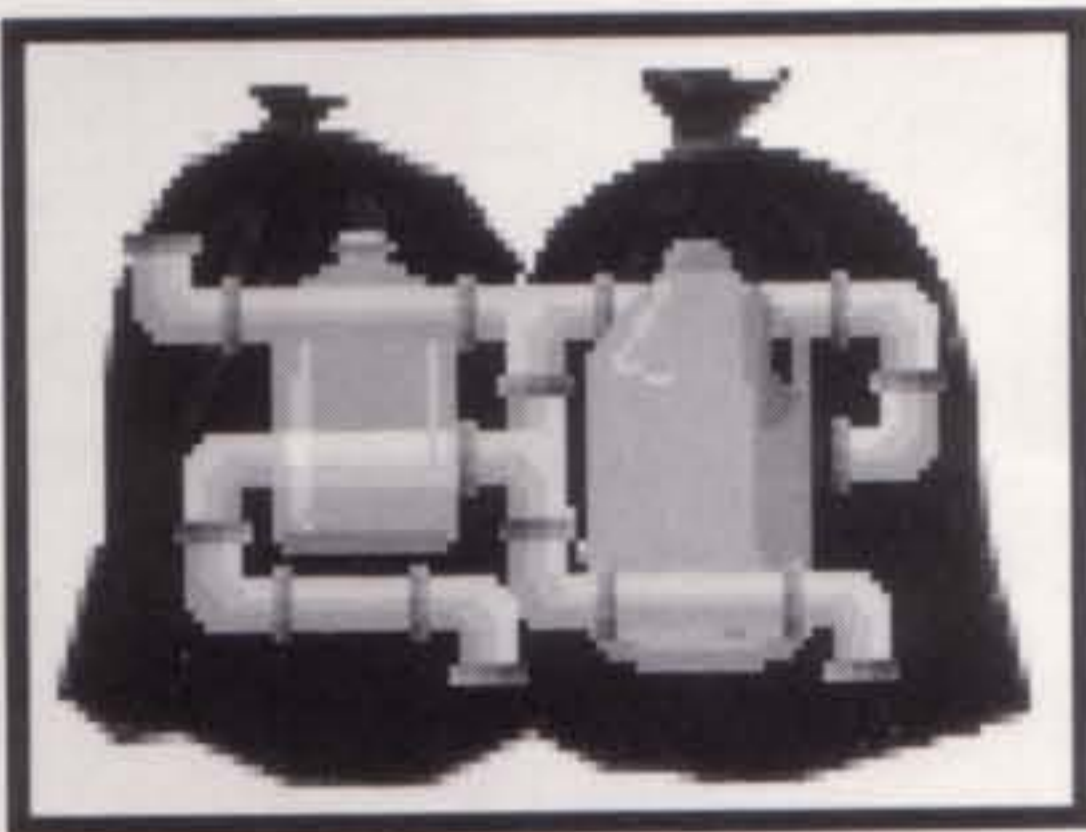

 Spaceship
Component



4. THE DYNAMICS OF CIVILIZATION

INTRODUCTION

Historian Will Durant describes four necessary elements of civilization: economic provision (food, shelter, and clothing), political organization (government), moral traditions, and the pursuit of knowledge and the arts. A society possessing these four elements is a civilization; a society lacking one or more remains primitive.

Economic provision, the first of these elements, is the most important. Steady and relatively abundant food supplies mean permanent living places are possible. Time is available for thinking and making improvements: better tools, better homes, better agricultural techniques, useful new inventions, art, music, etc. The result, over time, is a gradual, albeit fitful, increasing diversity in culture and knowledge.

Good food-producing areas bring unprecedented human populations together, and this aggregation creates a need for government. Governments provide the necessary decision-making process. As villages grow into towns and then into cities, more and more decisions are required. *If the decision process does not work, hostility or disaster might tear apart the group.*

Moral traditions provide a code of behavior that allows the group to stay together while minimizing friction between members. The code tells everyone how to act and what to expect from others. It is a set of rules for living in harmony: regulating marriages, setting sexual mores, defining vices, etc. Handed down generation after generation, the rules become second nature.

The moral tradition of most civilizations includes a religion. The great religions that have survived through the ages are those that offered reasonable moral traditions for living. Religions that failed often preached an inharmonious or destructive tradition. In some cases, a significant factor in the failure of a civilization was a flawed religion.

The pursuit of knowledge is a function of the spare time made possible by efficient food production, language, inventiveness, and incentives. The degree of inventiveness in any society depends greatly upon the incentive of rewards. A society that rewards new ideas, and encourages them, generally benefits; a society that discourages them risks stagnation.

Pottery



Granary



Hanging Gardens

A tightly structured and inflexible society may be very unreceptive to new ideas. Strict religious beliefs have hampered the development of many civilizations and continue to do so. The great ancient library of Alexandria, an immense storehouse of ancient knowledge, was destroyed by religious fanatics. The loss of the information in this library contributed to the length of the Dark Ages. The apparent collapse of many communistic societies today is in part due to their failure to develop and accept new ideas.

Societies that reward new ideas with riches, fame, and power encourage debate, thought, and invention. This may lead to a flowering of philosophy, science, and commerce. Inventiveness is characteristic of the strongest and most influential civilizations. Examples of this are the philosophy and science of the classical Greeks, the engineering of the Roman Republic, and the commerce of the Italian city-states during the Renaissance.

The pursuit of the arts is the final element of civilization, and again, the definition of how art is determined to be civilized or not remains unclear. Durant defines art as the creation of beauty. But beauty is a relative thing. What is beautiful to primitive man may be repulsive or plain to a modern gallery-goer, and vice versa.

To some extent, civilized art may be considered art for beauty's sake, an expression of thought or feeling that brings delight. In primitive art, the sense of beauty is a secondary characteristic. Primitive art first has a usefulness, like another tool, and performs a function. Adornment of the body, music, and dances help attract a mate. Primitive art also may serve a role in religion, enhancing the plea for good harvests, hunting, healthy babies, rainfall, relief from disease, etc.

The presence of these four elements together in a society define it as constituting civilization: economic provision, political organization, moral traditions, and the pursuit of knowledge and the arts. A society that lacks one or more never quite becomes civilized. A society that loses one or more over time falls back into a primitive state and disappears as a civilization. Through humankind's history many such civilizations have come and gone.

Railroad
(Steam Engine &
Bridge Building)

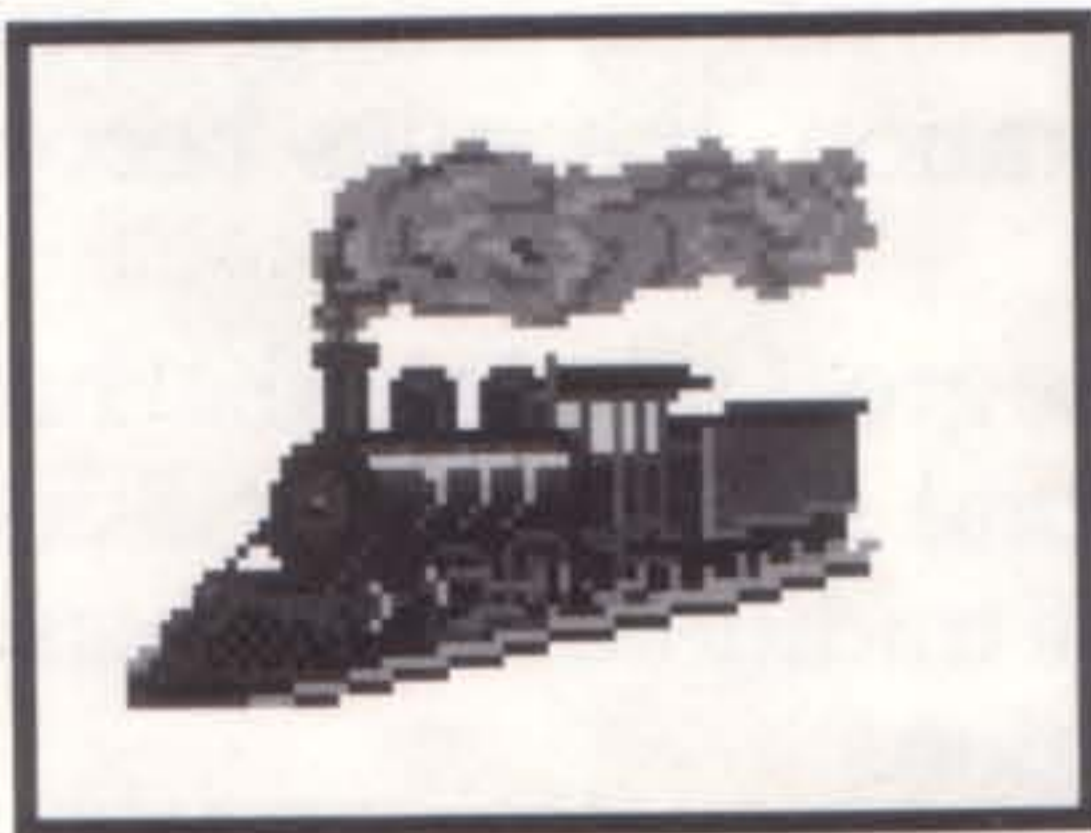

 Darwin's
Voyage

THE ADVANCE OF KNOWLEDGE

The major dynamic of change throughout the history of civilization has been the continuing advance and accumulation of knowledge. As humankind progressed by fits and starts through the ages, civilizations rose and fell, to a large degree depending on the knowledge that they acquired and how they employed it.

Those that first acquired new knowledge were often able to employ it to build a more powerful position. But there are many cases of civilizations that obtained some new technology first and then failed to use it to their advantage. The pace at which new knowledge was developed and implemented by a society depended on many factors, including its social organization, economic organization, geographic location, leadership, and competition.

The concept of progress being not only inevitable, but also a good thing is a relatively recent phenomenon. Only in the last several hundred years have we actively studied history and considered the evidence of the historical record. For most of human history the pace of progress was so slow as to be barely detectable. But since the Industrial Revolution, the pace of advance and change has dramatically increased. Rapid change is now considered normal. For much of the world, new discoveries are continually expected and are not a surprise.

There are those who would argue that the advance of knowledge is not necessarily a good thing. At various times in history some societies attempted to put a stop to progress. In most cases this decision was made by a few people in the leadership who thought they knew what was best for everyone. History shows that individuals continually attempting to improve their lives cannot be prevented from invention, and this in turn has made change inevitable.

It is clear that some invention occurs by accident. A string of idle thoughts may lead to a new conclusion, or an accidental mix-up in the chemistry lab may result in a useful new compound. But invention occurs much more commonly in response to a need.

When civilization began and humans started living in cities, a host of new problems arose. The search for solutions to these problems resulted in an accelerating pace of discovery of new ideas and inventions. A need triggered the search for new knowledge, and the new ideas created, in turn, new needs.

The advance of knowledge has been a continually evolving process, with each new idea leading to new possibilities. We can examine the progress of human societies as a series of changes and adjustments brought about by the never-ending search for improvement. The result of this dynamic process has been ever-expanding human populations, a generally improved standard of living, and a greater understanding of the world around us.

Recycling
(Mass Production &
Democracy)



Recycling Center

Antiquity

The singular technological achievement that was the prerequisite of civilization was the agricultural revolution. Humans changed from food gatherers and hunters to farmers and herders over several thousand years. Food supplies became more abundant and dependable. People began to congregate in cities central to their fields, specialize their skills, and employ free time to invent and ponder new ideas.

Farming created an increased need for food storage containers, especially in areas where crops were seasonal. Over a long period, experimentation with clay, the firing of clay, and eventually the potter's wheel, developed the technology of POTTERY and ceramics. This made the storage of food surpluses possible, and improved cooking and diet. The standard of living and life expectancy dramatically improved.

Critical to the progress of the new city dwellers was the invention of the ALPHABET and WRITING, considered by many to be the advance that marks the state of being civilized. Alphabets appear to have derived from symbols for sounds, concepts, and hand signals. Writing came about due to the need to pass on thoughts without talking or save them without memorization.

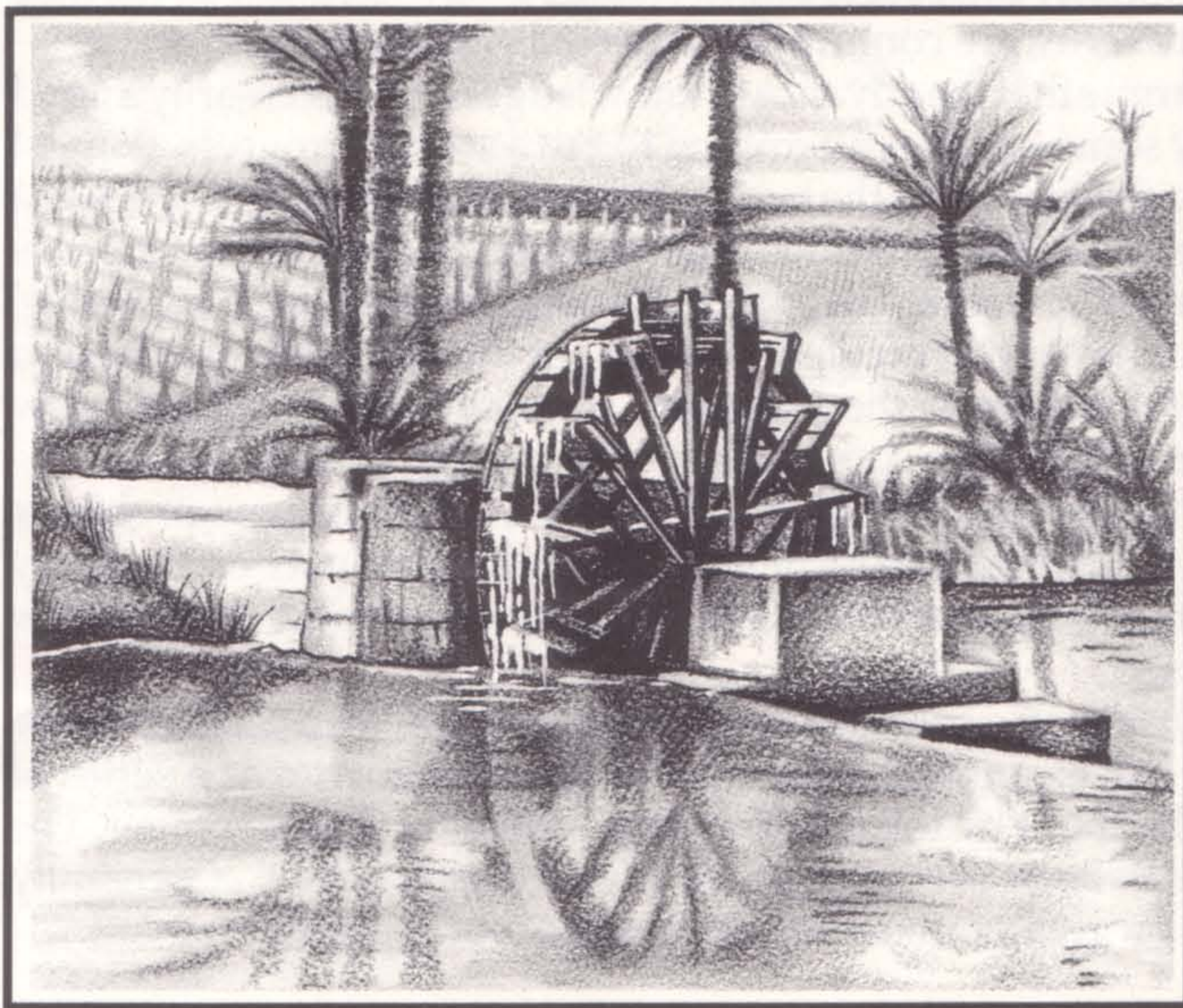

The waterwheel, critical to early agriculture

Symbols developed into the earliest scripts and hieroglyphics, pressed into clay tablets, carved into stone, and painted upon objects. The invention of written records meant that all previous knowledge did not have to be carried in the memory of the society and passed on orally. Knowledge could be stored and consulted later. From that point on the accumulation of knowledge accelerated.

The growth of the first cities and the establishment of permanent structures led to experimentation with various building materials. Humans learned to build with brick and stone, employing mortar to cement the individual pieces into a solid structure. This skill of MASONRY became even more important when walls were needed around cities for protection.

In those cities that grew large and wealthy, the demand rose for even more magnificent structures such as temples, palaces, and city gates. Also needed were more sophisticated defensive fortifications, aqueducts for water supplies, and harbor facilities. This created a need for more sophisticated techniques of CONSTRUCTION.

As empires expanded, they were connected by roads such as the Royal Road of the Persian Empire that extended from Susa to Sardis. This road, and the even more impressive network built later by the Romans, were huge projects. In order to be completed they required the invention of new designs for BRIDGE BUILDING. Roads and bridges built by the Romans still stand in many parts of the world and some remain in use.

Inside the first cities, people mingled and interacted on an unprecedented scale. This caused new problems that could not be met by old tribal standards of behavior. A Babylonian king, Hammurabi, is credited with the earliest surviving CODE OF LAWS that spelled out acceptable rules for making complaints, obtaining redress, and meting out justice. The code explained what behavior was unacceptable and set punishments designed to encourage compliance. Law was a needed complement to government, preventing anarchy within society.



Temple of Athena on the Parthenon, Athens

It was possible in prehistoric times to find relatively pure gold and silver lying exposed in the ground. Working with these soft metals led to experimentation with natural copper that also could be found. Eventually, our ancestors discovered how to smelt the green copper ores into copper metal. However, copper was not common, it was brittle, and it was too soft to hold an edge. Although copper was much superior to stone and made beautiful objects, it had only limited uses.

The ancient smelters continued experiments, trying combinations of copper with other metals. They were looking for a cheap metal that would make superior weapons and tools. When copper was alloyed with tin, the result was BRONZE, a much more useful metal. Some early conquerors extended their empires through the technological superiority of their bronze weapons. But bronze was still not available in large quantities, due to the scarcity of copper and tin.

Experimentation continued, and after many years, the secret of IRON WORKING was discovered. Some people believe that iron was the critical technology for the rise of civilization because it was easily found, harder than bronze, and could hold a better edge. It not only made superior and cheaper weapons, but also much cheaper and better tools.

The Hittites are thought to be one of the earliest societies to extensively develop iron working. They used iron weapons to conquer Asia Minor, and spread into the Middle East and Africa. For a brief period they held sway over a large empire due to this technological superiority. But they could not prevent others from acquiring the secrets of iron, especially their neighbors, the Assyrians.

The Assyrians were a remarkably brutal society that subjugated their empire by mass murder and enslavement on an unprecedented scale. Their military successes resulted not only from their acquisition of iron working, but also their independent development of the WHEEL. Although it had obvious peaceful uses for moving loads in carts, the Assyrians used the wheel to build chariots of war. They conquered Mesopotamia and Asia Minor, destroying the Hittites along the way.

In turn, the Assyrians fell when oppressed subject peoples turned the chariots around and overthrew their masters. The Assyrians had built their empire on the advantage of their chariots, but their brutal social organization created too much unrest to survive.

The earliest concepts of reverence for divine beings or supernatural powers must have been attempts by humans to make some sense of the great mysteries of life and the universe that surrounded them. Possessing barely a fraction of the knowledge that we do today, a divine explanation was needed to compensate for their utter ignorance of what forces controlled the Sun, the seasons, natural disasters, diseases, birth, and death.

The earliest societies developed rites of worship in attempts to communicate with and influence supernatural forces thought to be at work. Symbolic of these early rites was the CEREMONIAL BURIAL that prepared the dead for their voyage into the afterlife.

These rites of worship became ever more elaborate, paralleling the increasing sophistication of society. Typical of this sophistication was the development of MYSTICISM, whereby elite priests were attributed supernatural powers such as the ability to heal the sick and foretell the future. The Oracle of Delphi was such a mystic, examining entrails for portents of the future. For thousands of years kings and peasants alike were believers, conducting their lives according to the wisdom of mystics.

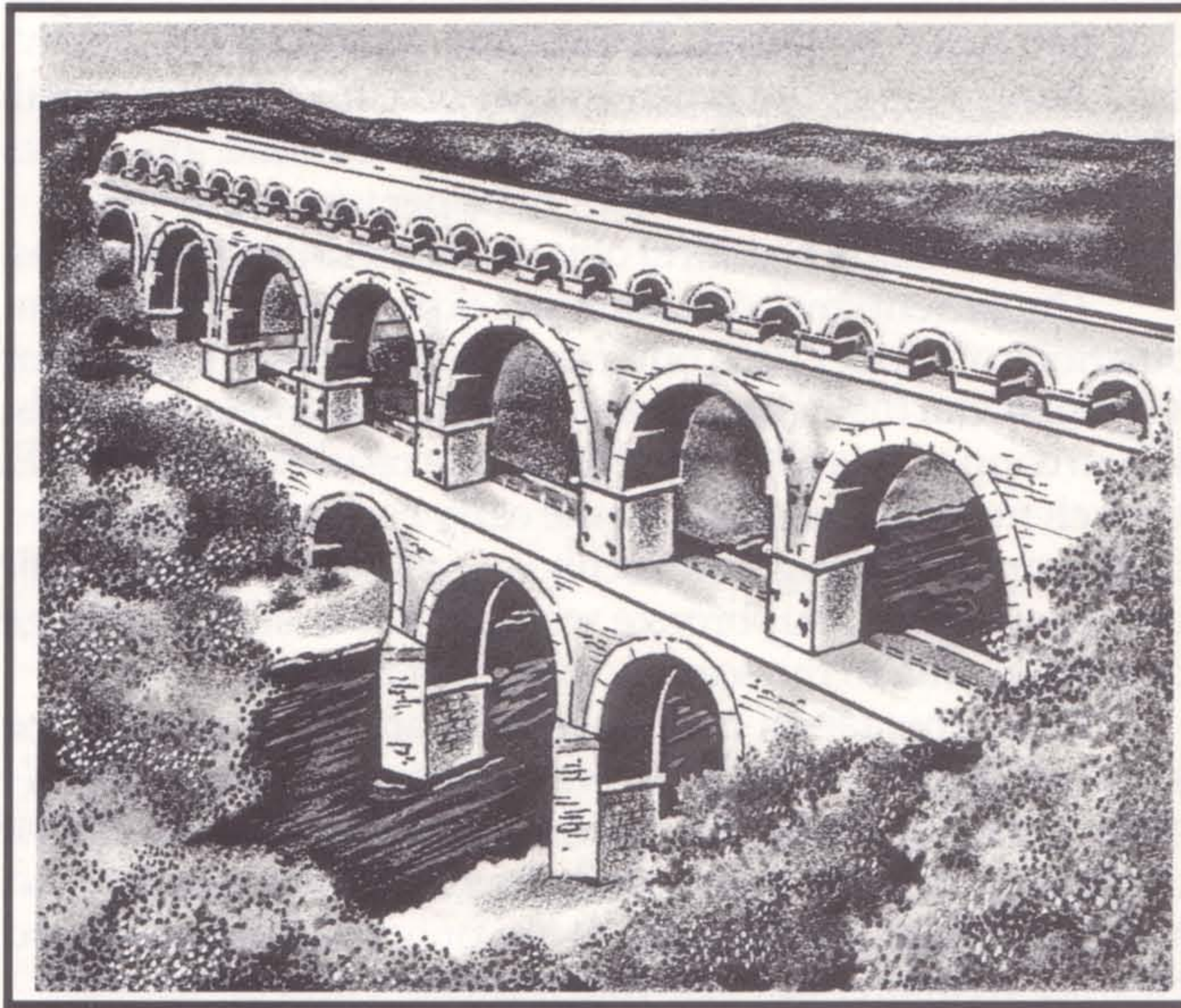

An aqueduct, typically superb Roman engineering

The most common early form of government was a despotism where one person held absolute power. This proved inadequate for many societies, especially those that established rule over a greater area than one person could control. In answer to this problem there arose a class of local rulers who in turn owed allegiance to the one overall ruler. The top person became the king of the MONARCHY and his power was delegated to his local representatives.

The class of aristocrats and governors that came into existence as the monarchy evolved had an incentive to make their fiefdoms productive because they normally kept profits in excess of those owed the king as taxes. At the same time, they acted as a check on the wilder schemes of the king who required their assistance when instituting policy. Monarchies continued to evolve for thousands of years, resulting in living conditions generally improved over despotism.

There is some evidence that writing was actually first used as to keep an accounting of commerce and taxes. Regardless of whether letters or numbers came first, societies that developed writing also understood the concept of numbers, addition, and subtraction. The need then arose for more useful systems of calculation for architecture, ship design, and science.

This specialized branch of study became MATHEMATICS, advanced most brilliantly by the Greeks according to the historical evidence. Their work was used by the famous Roman engineers of antiquity and preserved by the Muslims during the Dark Ages. The Muslims continued to build on the Greek work and developed the numerals used today in most of the world. As the Dark Ages came to an end, the ancient math of the Greeks and others was recovered by the West from the Muslims.

As cities and empires grew, and the economic relationships between the providers and consumers grew more complicated, there arose a need for what we now know as money. The primary functions of money were to be a medium of exchange, a storehouse of value, and a standard of value. Prior to its existence all trade and exchange was done by bartering. The first CURRENCY is attributed to King Croesus of Lydia who made coins of electrum, a naturally occurring alloy of gold and silver found abundantly in his kingdom. When the Persians, a newly risen despotism that replaced the Assyrians, conquered Lydia, they retained the use of currency. Thereafter, it spread rapidly around the world.

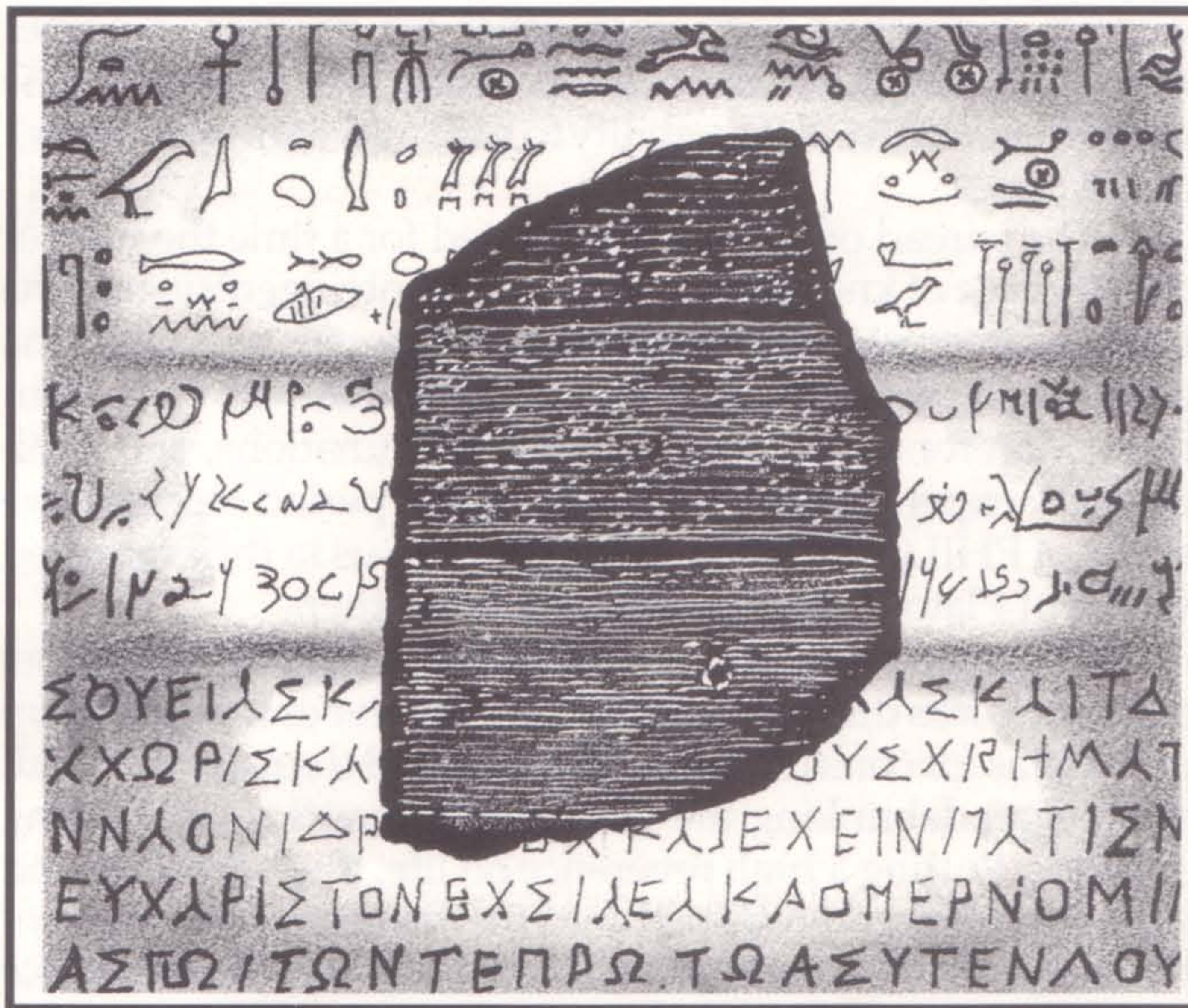

The Rosetta stone, deciphered by Champollion

The exchange of goods and services had been going on for ages in the tribes of prehistoric humans. This barter flourished within the new cities as some people specialized in food production, and others in building, tool making, pottery making, etc. After the development of money, TRADE between civilizations grew in volume and intricacy.

Because of variances in climate, geography, or resources, people in different parts of the world often held a comparative advantage in the production or accumulation of certain goods. By exchanging with each other, two people could end up with more than if they relied on their own industry. An additional benefit of trade was the dissemination of new ideas around the known world.

The rise of classical ancient civilizations in China, Greece, Rome, and other places was due to a rapid increase in the economic strength of these societies. The Han dynasty of China established control over a very fertile area that prospered with little outside interference. The Greek city-states prospered by establishing colonies around the Mediterranean and competing vigorously with each other. The Romans drew their economic power from fertile lands, a relatively free citizenry, and military superiority.

All of the classic civilizations were characterized by unprecedented wealth spread over more people. This resulted in a flowering of the arts and sciences, patronized by the newly rich classes of merchants and bureaucrats competing with each other for prestige. Another

way to distinguish themselves from the peasants was through LITERACY. The ability to read and write was a mark of eminence.

The spread of literacy accelerated for a time the pace of the advance of knowledge. The literate intelligentsia had the time and interest to ponder all manner of topics, especially the great mysteries of life and the universe that had been troubling Man for eons. From debates, examinations, and rudimentary experiments, the Greeks of this period founded the study of PHILOSOPHY, passed down to us in the preserved works of Plato, Aristotle, Socrates, and others.

The philosophical and scientific studies of the Greeks set off a fireworks display of ideas. This shower of thought lit up new vistas for consideration. They studied the natural world, and began debunking the fables of the mystics and finding answers. Putting a high reverence on life, their curiosity and experimentation developed into the first scientific study of the body, disease, and MEDICINE. They combined science with the practical knowledge of herbs and other treatments handed down over the ages.



Longboat of Viking raiders

Turning their eyes to the heavens they correctly deduced that the Earth revolved around the Sun. This and other discoveries were the beginnings of ASTRONOMY, a science that evolved from mystical observations of astrology. These early understandings of the heavens led to practical uses. Sailors of antiquity had been forced to sail by dead reckoning or stay close to shore following MAPS. Astronomy and experience revealed useful patterns of star placement and movement that could be used as aids for NAVIGATION.

The studies of the Greeks also led them to create a new form of government, the DEMOCRACY, that seemed best suited for encouraging economic and personal freedom. But their democracy applied only to the elite males, not to the peasants, slaves, or to women.

Greek economic and military power eventually declined, expended in wasteful wars. They were overwhelmed by the military power of the Romans to the west and the promise of their burgeoning of science and knowledge remained unfilled for over a thousand years.

Roman society was much less elitist than the Greeks, at least at first, and the people were more practical than contemplative. The Romans absorbed the science and mathematics of the Greeks, and employed them in famous works of ENGINEERING. The Romans are considered the great engineers of antiquity, building roads, bridges, aqueducts, fortifications, harbors, and other structures wherever they went. The West did not see the like again for many centuries after their collapse.

Early Roman society was based on a new type of social organization where the land was owned by many, not just a few aristocrats. This policy resulted in a strong economy. In addition, the citizens were the army, and their training, tactics, leadership, and morale made them a nearly invincible force. These were all new ideas and required a new form of government. In response, and drawing on the ideas of the Greeks, the Romans developed the REPUBLIC.

Under this government, the large land-owning class chose representatives to rule for them in a new parliamentary body, the Senate. In turn, the Senate chose the ultimate leaders of government and the generals of the armies. For centuries the republic functioned very well, stimulating economic production, meeting all military crises, and eventually dominating most of the Mediterranean basin.

The rule of the Roman Republic was usurped by a series of leaders who installed themselves as emperors. From this point on the empire began to falter, shored up occasionally by an able leader. The land-holding citizenry disappeared, bought out by rich generals and others. The Senate became corrupt and ineffectual. The economy became increasingly reliant on slave labor and the citizen army was replaced by mercenaries.

After four hundred years of decline, the western half of the empire fell to barbarian invaders. The eastern half carried on for another thousand years before succumbing to the Muslims.

Refining
(Chemistry &
The Corporation)



Power Plant

THE MIDDLE AGES

In Asia, the Chinese successfully held off the barbarians for many years, partly due to their Great Wall. Their civilization offers many interesting contrasts to those of the West. Chinese society was managed by the Mandarins, a class of bureaucrats. They strictly followed a conservative orthodoxy derived from the philosophy of Confucius that emphasized personal virtue, devotion to family, and justice.

As practical managers, they studied science and technology, and encouraged INVENTION, but only because they thought it was important for their emperor to have this knowledge available. They are credited with a number of important advances including paper, the printing press, MAGNETISM, and GUNPOWDER, but did very little with them. In their view, the society that they maintained according to Confucian principles approached perfection and there was no need for these new inventions.

So Chinese society continued to discover interesting things, only to have them exist mostly as curiosities. They actively discouraged change and advance, sealing themselves off from the rest of the world. At one point they sailed a mighty fleet of ocean-going ships past

India to Africa, but after discovering nothing new of interest, the emperor forbade further ocean voyages and the fleet was beached to rot.

The Chinese civilization continued like this for many centuries after the fall of the Romans, but eventually fell victim to fierce Mongol armies from the north that the Wall could not hold off. But the Mongol conquerors were absorbed by the Chinese culture and the ossifying influence of the traditional orthodoxy continued to dominate the culture. When the West arose from the Dark Ages, it quickly eclipsed the power of the ultra-conservative East.

While Confucianism dominated China, the philosophical studies stimulated by the Greeks exposed flaws in the mysticism and cults that had dominated spiritual matters in the West. Many new beliefs sprang up to fill the void, and among these were the beginnings of the RELIGIONS which dominate spiritual life today. These new creeds made it possible for people to find fulfillment and peace within an increasingly complicated, crowded, and demanding world.

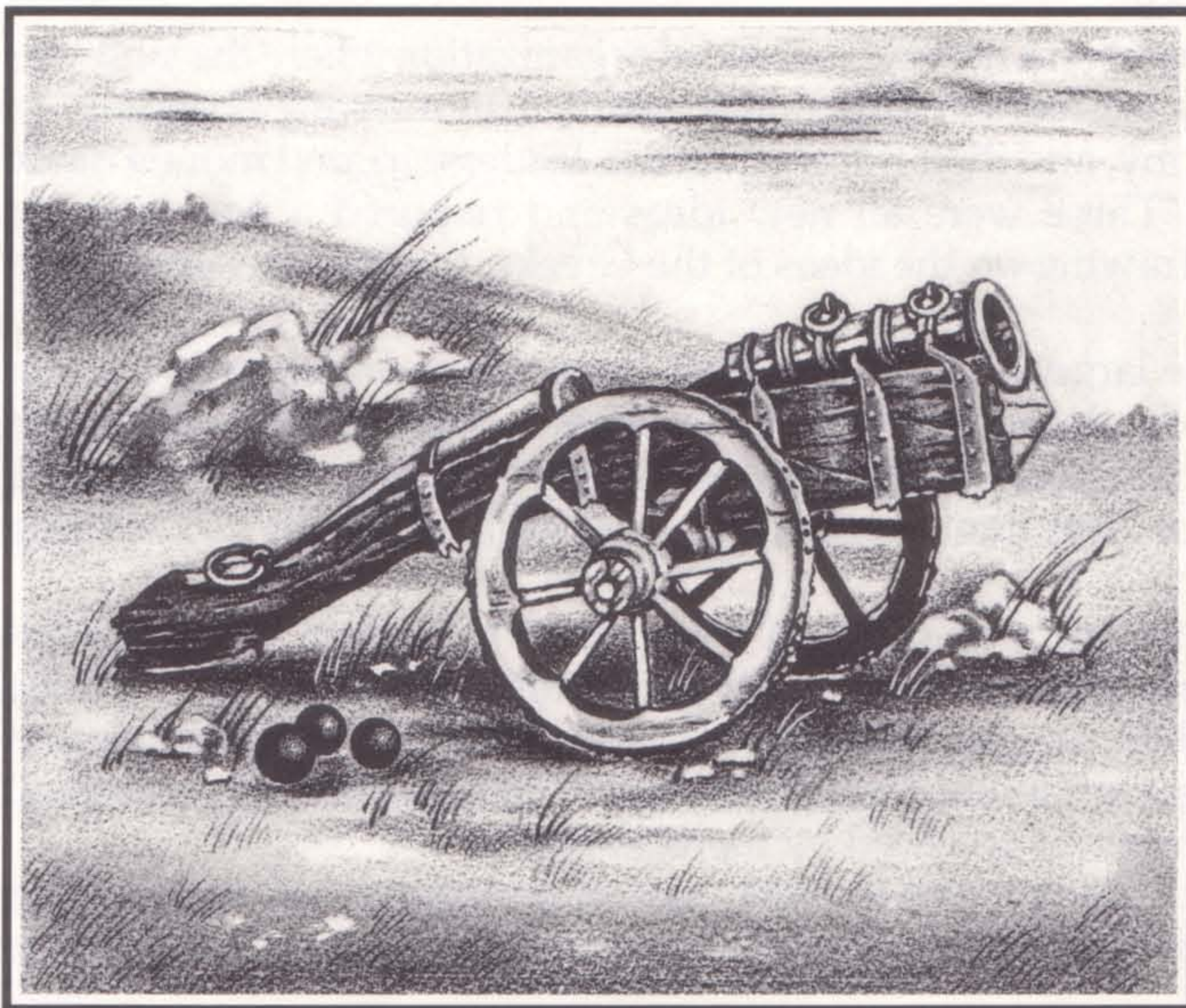

An early cannon

With the fall of the Roman Empire, Europe fell into a Dark Age dominated at first by the barbarian conquerors. The Chinese isolated themselves, the Byzantines and the Muslims fought for the Middle East, and the rest of the world struggled with their own first attempts at civilization.

The barbarian possession of Europe ruined economic production, disintegrated the governmental infrastructure and laws, and decimated populations. For hundreds of years the whole region returned to a barbaric, primitive existence.

Strongmen established local rule and the ablest began building larger kingdoms. The local baron provided protection, law, and order for the people that were his effective slaves. He held his fiefdom by the permission of the king, and owed the king taxes and service in payment. This brand of monarchy became known as FEUDALISM.

As the degree of order grew and populations recovered, the strands of knowledge were gradually regathered. Some of this knowledge had been preserved by the Church, and some was obtained from outside Europe.

Improving economic conditions made the upper class wealthy. The social climate called for a new code of behavior to distinguish the aristocrats from the tiresome laborers and merchants. The elite became knights, directed by a code of CHIVALRY. Departing radically from the barbaric past, the warrior was expected to protect the weak, prevent evil, and follow the teachings of the Church.

The revival of Europe was a gradual process, powered by increasing economic production. Trade flourished at fairs and overseas, towns grew, guilds of tradesmen improved skills, and crude industry started. The quest for knowledge was again stimulated, partly by tantalizing information drifting in from China and Arabia, and partly by debates over Church dogmas. In an effort to benefit from the new knowledge, kings established the first UNIVERSITIES.

University scholars expanded the scope of their studies and began considering the same problems that had engrossed the Greeks far in the past. The attempts of alchemists to turn base metals into gold resulted in the science of CHEMISTRY. This new science led to improvements in industry, munitions, and medicine. Other experiments began revealing the secrets of matter and motion, the natural laws that controlled how things worked. The study of astronomy led to PHYSICS.

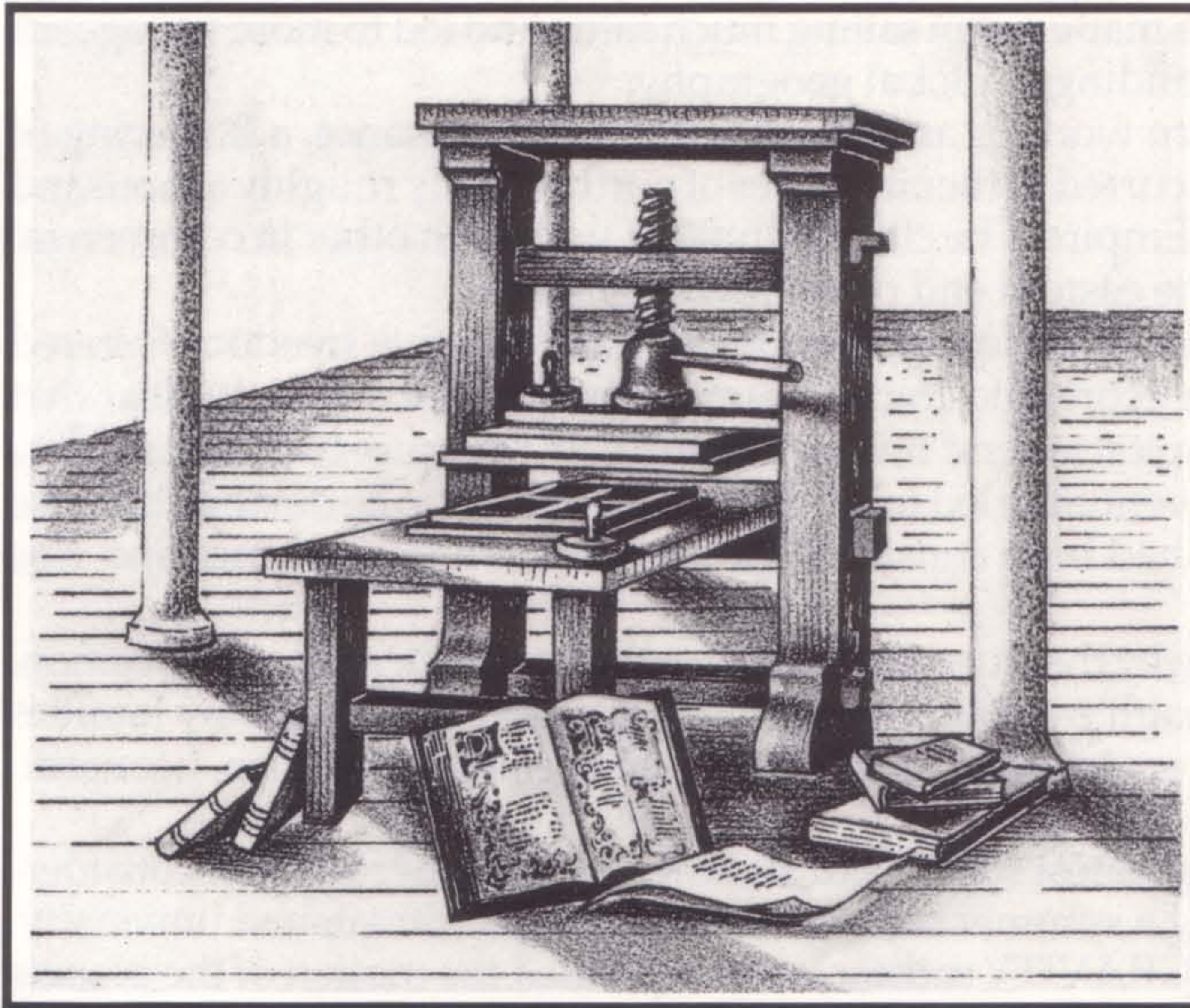

Gutenberg's printing press

Sketchy accounts of marvels witnessed in China drifted over the trade routes to the universities and merchants of Europe. These accounts led to experimentation in attempts to duplicate the inventions reported from the East. Most important of these was the fabled exploding powder.

The Chinese were mainly content to use GUNPOWDER for fireworks, but the small states of Europe were continually embroiled in wars and were looking for any possible technological advantage. An explosive power promised military advantage if it could be harnessed. While the discovery of gunpowder was occurring, new developments in the study of metals and manufacturing became the science of METALLURGY. The marriage of gunpowder with cast bronze and iron tubes created cannon.

The development of cannons and muskets was a major revolution in warfare. The search for a way to end the dominance of the battlefield by armored cavalry was over. Relatively cheap musketeers could shoot down the expensive cavalry at a very profitable rate. Armed with the new weapons, the Europeans ended the threats of the Muslims and Mongols, and began extending their own empires around the world.

At a time when Europe was beginning to expand overseas and searching for trade routes to Asia, there was a strong need for better tools for navigation. One answer was another invention of the Chinese that eventually reached the West: MAGNETISM, important in the compass. Mastery of the compass made ocean sailing much safer, and led to more voyages of discovery and a greater understanding of global geography.

The beginning of the modern world is associated with the Renaissance, a flowering of trade, science, and the arts that occurred in the city-states of northern Italy roughly a thousand years after the fall of the Roman Empire. The cities competed with each other in commercial enterprises, mainly trade with the eastern end of the Mediterranean.

As with the Greek city-states of antiquity, competition and relative freedom fostered rapid economic growth. As their economic empires grew, it became increasingly clear that there was a desperate need for capital to fund trading ventures. In response to this need, they developed a number of ploys that eventually led to BANKING. They had to be devious because the loaning of money at interest had been considered a source of evil for centuries and was proscribed by the Church.

The development of banking by the city-states further enhanced their economic position. One benefit of this increasing wealth was the patronizing of the arts and sciences by families such as the Medici. We have this era to thank for Donatello, Michelangelo, Galileo, Leonardo Da Vinci, and many others.

Isaac Newton, perhaps the greatest scientist of all time, tied together years of consideration of the laws of nature during a summer sojourn from his plague-threatened university. His treatise on the THEORY OF GRAVITY satisfactorily explained the motion of the planets as well as why objects fell to Earth, and was the take-off point for most science for the next several hundred years. Newton is also credited equally brilliant works on light, optics, and calculus, any one of which would have made him famous.

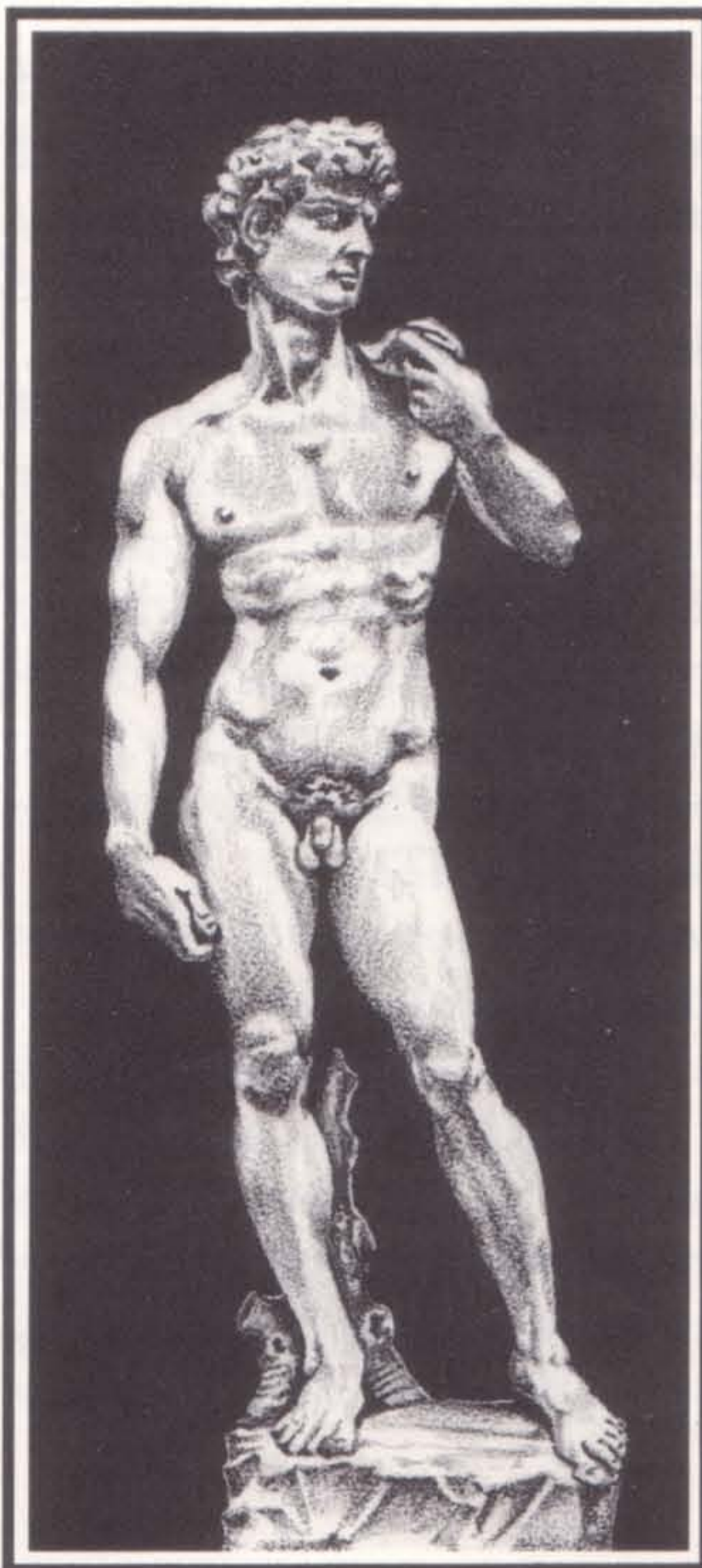

Michelangelo's sculpture of David

THE INDUSTRIAL AGE

Within a generation of Newton's death, the Industrial Revolution took off in England. At the time, England possessed one of the strongest and most rapidly growing economies in the world. The population was relatively well educated, there were numerous small industries already in place, and the government was encouraging commerce. This was a fertile environment for invention.

The spark of the revolution came from the need to pump water out of deep coal mines. Inventors tinkered with a number of mechanical methods of getting water out, but in the end the best solution was a crude STEAM ENGINE connected to a pump. The refinements of the early steam-powered pumps took a number of years, but resulted in an engine that could provide power from burning coal for any number of enterprises.

The significance of the Industrial Revolution was that the production of a single worker could be dramatically increased by machines. The new machines were powered first by coal and later by other energy sources. They were no longer dependent on animal or water power. Machines could be placed nearly anywhere, even inside ships.

Rapid economic growth accompanied the Industrial Revolution in England, resulting in dramatic increases in the production of textiles, iron, and other goods. This increased the need for an improved transportation system throughout the country. At first this need was met by the construction of a network of canals linking the country's rivers. But inventors looked for better alternatives, and came up with the idea of RAILROADS powered by steam locomotives.

Railroads spread quickly throughout Europe and North America, and eventually reached the corners of the world. They were important not only because they speeded up communication and delivery of goods, but they in turn triggered innovation as inventors continually searched for ways to make them more efficient.

The ability of railroads to haul great loads of raw materials and finished goods made it possible for the new industrial managers to consider even larger manufacturing enterprises. It soon became apparent that INDUSTRIALIZATION meant low costs due to the economies of large-scale production. Large factories and mills sprang up around the world as more and more countries industrialized.

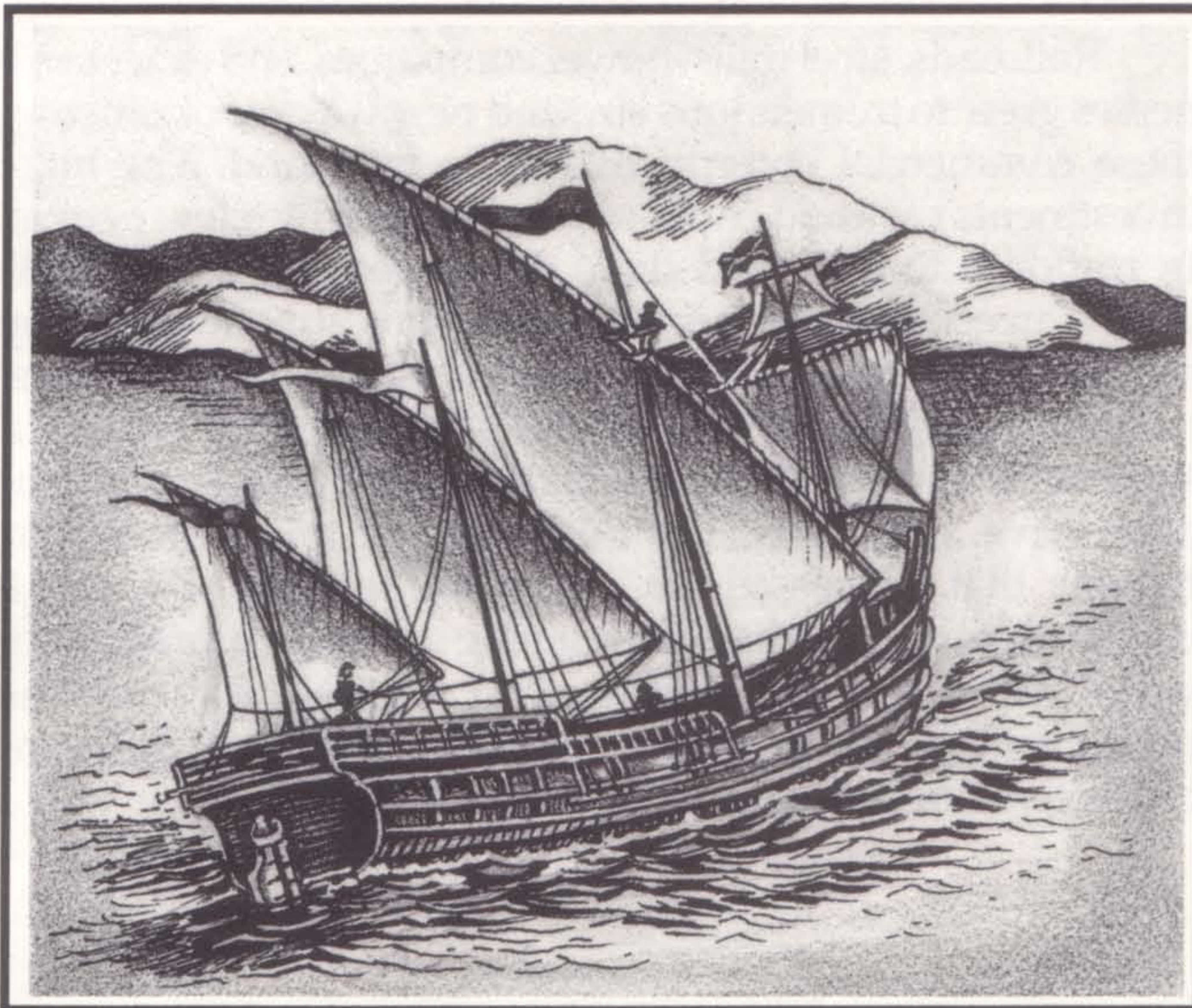

Spanish caravel, the ship of discovery

The new industries and the railroads were great construction projects and they created the demand for stronger and cheaper building materials. Railroad bridges, rails, factory buildings, and city skyscrapers were limited by the strength and durability of iron. The answer was the development of STEEL, a nearly perfect building material that eventually could be made quite cheaply.

Industrialization accelerated the advance of knowledge. The great fortunes that could accrue to the innovator encouraged new invention. The advance of physics, chemistry, mathematics, and engineering offered new tools for experiments. Laboratories were created solely for research.

One major goal of this research was the search for alternative ways to generate and transmit power. While the steam engine was revolutionary, every factory had to have its own. More useful would be a central power generating station that sent out energy to users.

The phenomena of lightning offered a clue. The properties of ELECTRICITY were discovered by Michael Faraday, a British chemist and physicist. He invented ways to generate electricity, to transmit it, and to employ it as an energy source to power machines. His inventions transformed the daily lives of much of the Earth's population, improving working conditions, bringing labor-saving devices into the home, and creating the opportunity for a wide range of new inventions.

Railroads, steel mills, power companies, and other businesses grew to tremendous size and new ways of organizing these commercial enterprises had to be found. The huge investments required could not be financed by a few people. In response to this need there developed the CORPORATION, an economic entity that raised investment capital by selling shares of ownership to a great many small investors.

Inventors began looking for alternatives to coal as a sources of energy. Coal was bulky and burned dirty. An alternative was especially desirable for those areas and nations that possessed no coal. One solution was oil, a messy nuisance that had been laying around for millions of years. With the development of REFINING, oil was transformed into a variety of fuels that had different characteristics and uses.

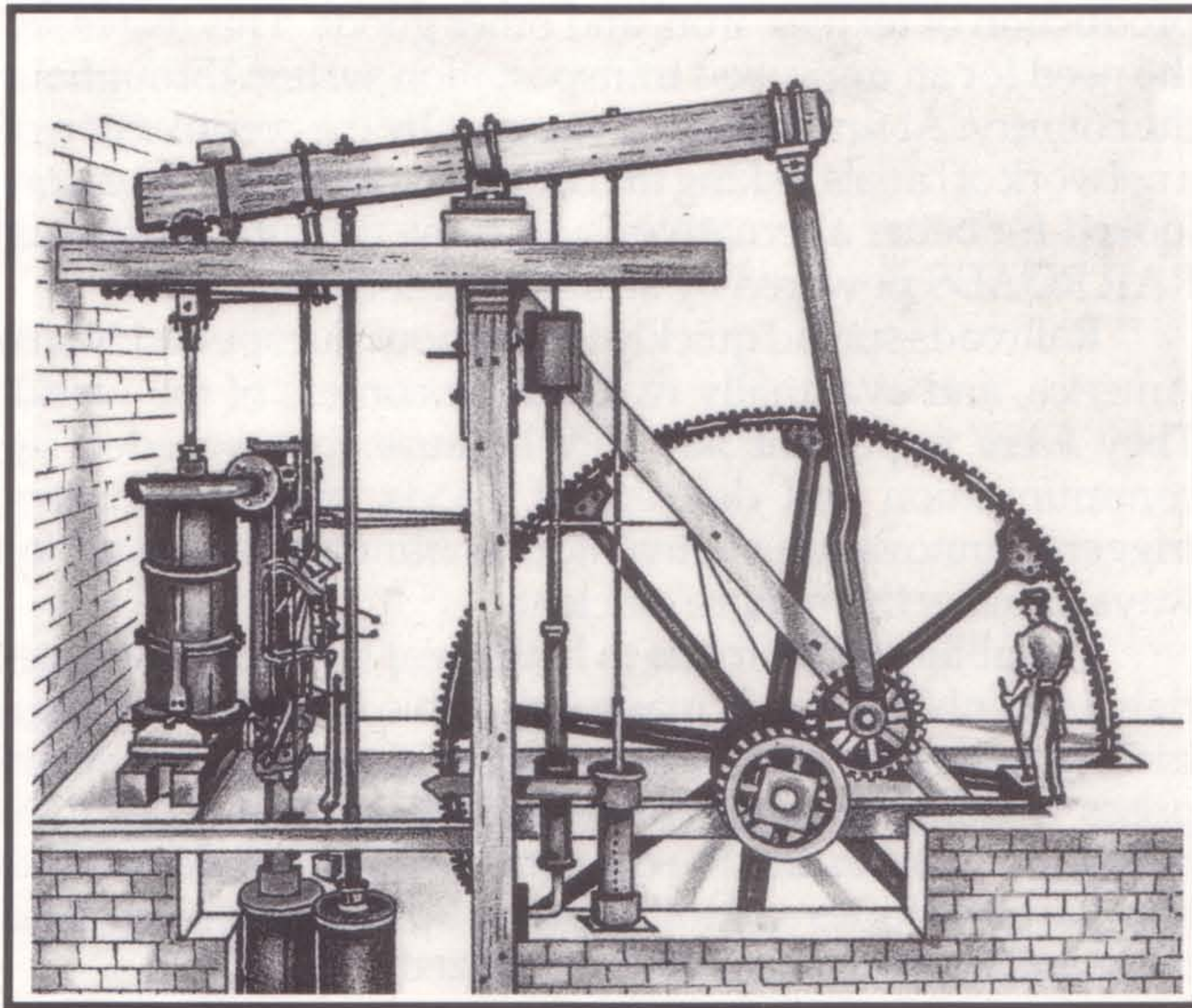

Watt's steam engine

A new round of experimentation followed, searching for an engine that could take advantage of the explosive properties of gasoline, a refined product of oil. The result of this experimentation was the internal COMBUSTION engine that converted the energy of gasoline and similar fuels into horsepower. Oil fuels were less bulky and burned more cleanly than coal, and set off a wave of new industries that built machines employing internal combustion engines.

Following the success of the railroad, people experimented with a number of ideas for machines that would move over land. They were looking for something to replace horse-drawn vehicles that were crowding the growing metropolitan areas. Steam-driven vehicles showed some promise, but the answer was the AUTOMOBILE, powered by the new internal combustion engine. The automobile became the greatest consumer good to date, and also revolutionized warfare when modified into armored land battleships called tanks.

The internal combustion engine was also the answer to one of humankind's oldest and most cherished quests: to fly. Experimentation with flying had been going on for many years, first in balloons, then gliders, and with various attempts at human powered flight. The new engine was light enough and sufficiently powerful to make flying possible. The first powered FLIGHT was accomplished by the Wright brothers, and improvements in engines and aircraft design followed rapidly.

The laboratories and classrooms became the center of invention as the technological complexity of experimentation grew. The thinking of physicists built on the work of Newton and again revolutionized our understanding of the universe. With the aid of marvelous new machines to aid research, the search for the building blocks of matter resulted in ATOMIC THEORY, the description of atoms and molecules.

Scientists and industrialists alike continued studying electricity and developed many new uses for ELECTRONICS. Experimentation led to the telegraph, telephone, recorded sounds, radio, and television, and many other electronic gadgets that were useful in the home and for industry.



The electric light bulb

Manufacturing became a science itself. Industrialists continually looked for ways to speed production, improve quality, cut costs. Early ideas had been the specialization of labor where one person did one job over and over, becoming expert at it. Another innovation was precisely made interchangeable parts. Henry Ford is credited with developing MASS PRODUCTION with the installation of the assembly line in his automobile factories. Production of machines and consumer goods soared.

The dramatic changes of the Industrial Age did not benefit everyone equally. The capitalists grew wealthy while the standard of factory workers often deteriorated. Governments that were not flexible enough to evolve to meet the demands of the new age were violently overthrown. The philosophers proposed new organizations for society that appealed to the working class, including socialism and COMMUNISM.

The communism of Marx and others was to be a worker's paradise. There was to be no social hierarchy, and the means of production and subsistence would be owned by all. The people of many nations, both industrial and agrarian, overthrew obsolete and unresponsive monarchies, and installed communist governments.

Nearly a century of experimentation with communism proved that its lofty goals could not be reached. The surrender of personal and economic freedom to the state resulted in lower standards of living, not greater, and a new class structure of privileged party members

replaced the old. Some technical advance was possible, but only at great cost. Communism was unable to compete with the free-market democracies in either technical advances or general happiness.

In the more flexible societies, the industrial workers were not able to gain control of the entire government, but they were able to improve their lot. In this period of rapid change, society was unprepared for the unrest that inequitable distribution of wealth caused. Although eventually a number of steps were taken to improve this condition, the workers themselves took matters into their own hands.

Striving for a greater voice in the affairs of their lives, industrial workers developed techniques of work stoppages, strikes, and boycotts. Eventually they formed LABOR UNIONS through which they could present a unified front in negotiations with managers and owners. The labor movement was the result of the greed and imperiousness of the rich industrialists. The unions brought an equilibrium between the two forces, though the balance was subject to swings in either direction.



Wright Brother's Kitty Hawk

The technical advances of the Industrial Revolution were partially spurred by the arms race. The industrial powers vied with each other for colonial empires and continental dominance. Each turned to its engineers and scientists for superior weapons to improve their diplomatic and military position.

In the air, the arms race resulted in very rapid progress. In some of the larger conflicts, new aircraft designs were made obsolete in only a few months by the appearance of the next generation of aircraft. Jet engines, swept wings, helicopters, and aircraft carriers were examples of **ADVANCED FLIGHT** systems. Additional pioneers worked on a new system of propulsion that could power unmanned aircraft, perhaps into space. The solution was **ROCKETRY**, developing into missile weapons and space launch vehicles.

The design of the aircraft and other machines was limited in some cases by the construction materials available. This created a demand for replacements for wood and steel that retained their strength yet were lighter. Research discovered a range of new materials, primarily **PLASTICS** developed from petroleum. Plastics proved to be useful for a wide range of applications, and created opportunities for many new industries. They were especially valuable in space vehicles due to their unique properties.

The increases in invention, production, and communication created the need for improved tools for record-keeping and calculation. Super-calculators were first considered early in the Industrial Age, but no practical model was built. Electronics offered a new opportunity and the first **COMPUTERS** were born to help codebreakers during war.

Computers triggered an information revolution, that may yet prove as dramatic a break in human history as the previous agricultural and industrial revolutions. Calculations that were previously impossible were finished in seconds. This made previously unthinkable research and precision now routine. Mountains of information were reduced to tiny chips of silicon, yet remained accessible.

In the manufacturing plants, researchers continued seeking ways to improve quality and reduce costs. The next step in automation was the installation of complex **ROBOTS** that could endlessly repeat certain movements. This freed human workers from these numbing tasks. In addition, robots could work in environments that might be inhospitable to humans, such as space.

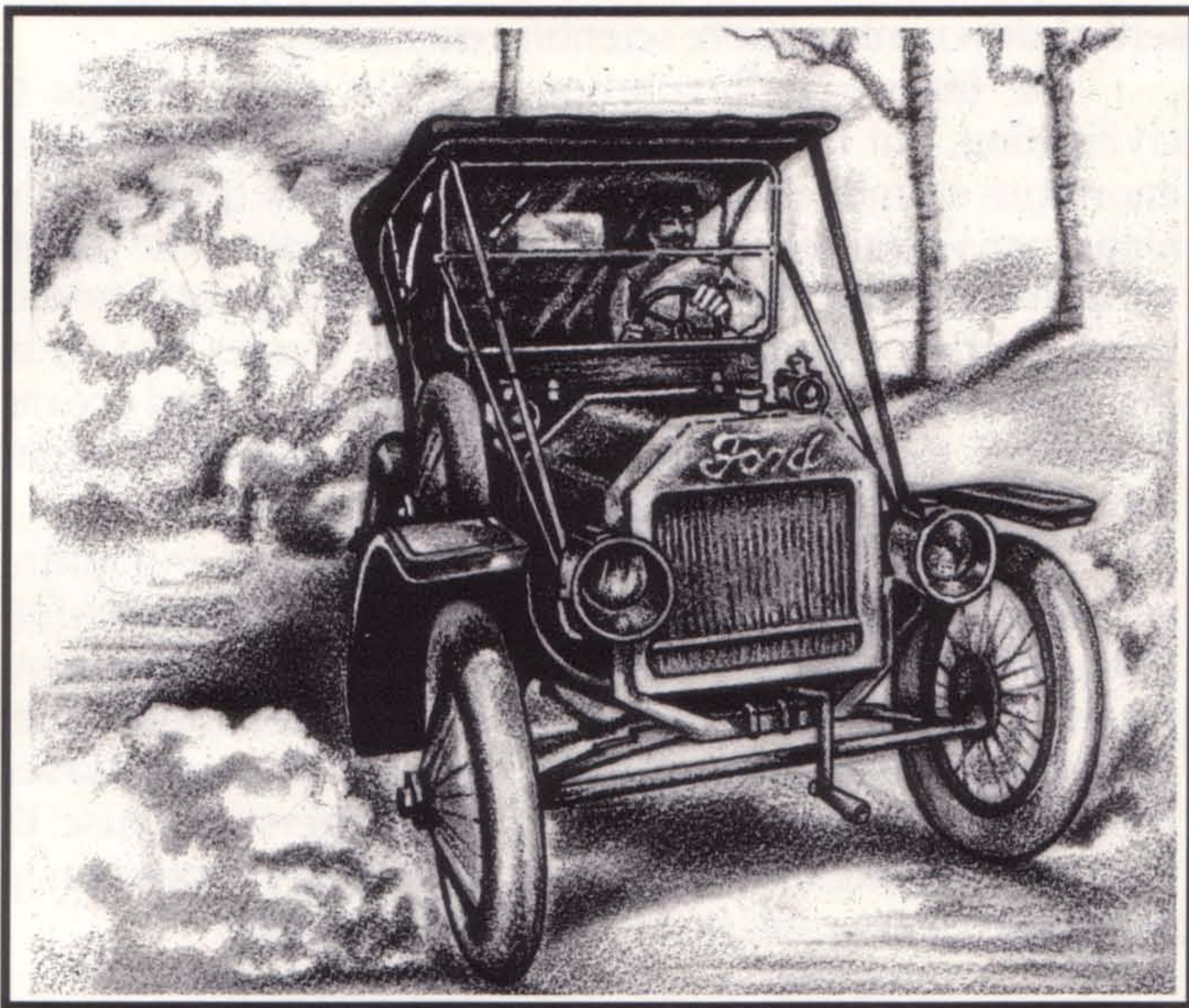

Henry Ford's Model T

The search for the ultimate strategic weapon was undertaken by the United States. It was to be so powerful that it made war obsolete. A team of physicists, building on their knowledge of atomic theory, eventually discovered the technology of NUCLEAR FISSION. This made possible the construction of the first atomic weapons. With the spread of these weapons among the most powerful nations, the risk of world war decreased because it was clear there would be no winner after a nuclear exchange.

The enormous energy output of nuclear fission suggested peaceful uses as well. Experimentation proved that electric power could be generated from nuclear reactions. At first thought to a great advance, NUCLEAR POWER was found to have certain risks attached that reduced its value. The fuel of the nuclear reactors was not only lethal, but the waste products required special handling. A number of disasters at nuclear power plants indicated that this energy source was much more difficult to harness than hoped.

The race into space was born as much from international competition as from any interest in science. To the industrial powers, each major first in space meant prestige and was clear proof of the superiority of their society. After a number of spectacular successes and tragic failures, the world concluded that the benefits of SPACE FLIGHT would be slow in coming and costly to achieve. Once the competitions had run their course, the exploration and potential colonization of space settled down into a more scientific exercise.

The Industrial Revolution brought great change to civilization, but not all of it was beneficial. The burning of enormous quantities of coal and oil lowered the quality of the air humans breathed in many areas. In some cities, the people wore masks to filter the air they breathed. The great increases in production meant huge quantities of wastes had to be disposed of, and too much of it ended up in rivers and oceans. Unbridled industrial development risked global warming and the poisoning of the Earth's air and water.

The richer industrial nations took the lead in fighting pollution, putting restrictions on the dumping of wastes into rivers and the air. Cars were required to be cleaner. In many places a priority was placed on RECYCLING, by which paper, aluminum, glass and other waste products were saved from the dump and returned to manufacturers for re-use. By this practice, long in place in the steel industry, a percentage of new products consisted of recycled materials.

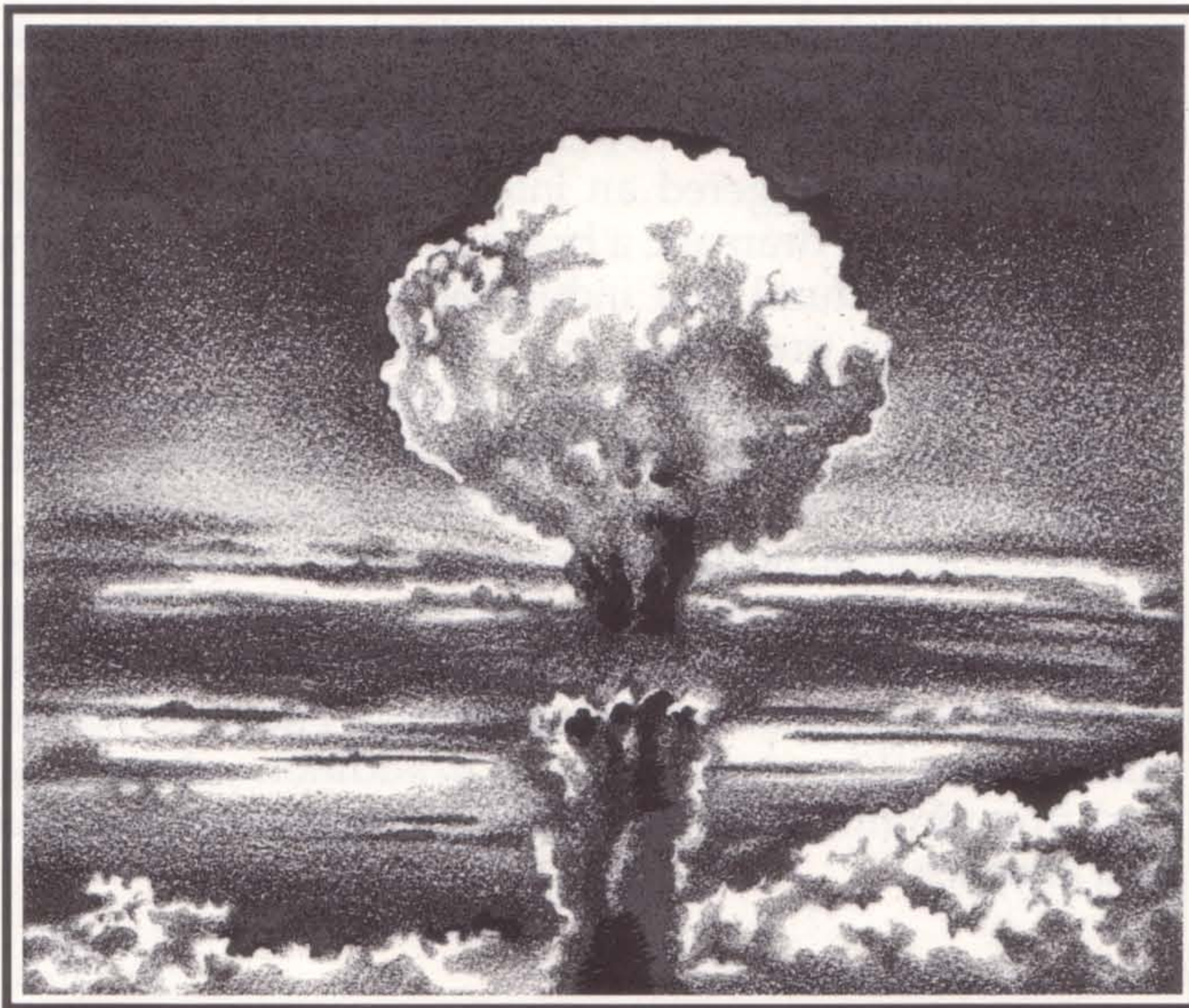

Nuclear detonation dust cloud

The quest for new technology continues today. Scientists are doing research in a number of areas that could lead to dramatic advances that will impact future societies.

One important area is GENETIC ENGINEERING. If humans can learn how to do this, we may be able to prepare better animal stocks, better crops, cure diseases such as cancer, and eliminate genetic defects that cause retardation. While this research continues, so also does the debate on the ethics of genetic manipulation. Especially among religious groups, there are concerns about the appropriateness of such research.

Scientists are also searching for a SUPERCONDUCTOR. If this material could be found it might also have dramatic effects in daily lives throughout the world. It is significant because a great deal of energy is lost when electricity is transmitted over distance. The superconductor would greatly minimize this loss of energy, resulting in great increases in efficiency and reduction of costs.

Experimentation also continues in an effort to develop FUSION POWER, a potentially limitless energy source. Fusion of molecules of heavy water, a relatively cheap raw material, results in the release of tremendous energy in the form of heat. This heat could be converted into electricity. The development of fusion power would mean extraordinarily cheap electric power with almost no environmental risk.

In retrospect, the advance of civilization seems to have been inevitable. Although at various times and places this advance was halted, or even went backwards, somewhere in the world progress continued. A more detailed examination of history can better explain why the process speeded up and slowed down, why certain civilizations advanced rapidly for a time and then declined. But it seems clear that the acquisition of knowledge and its application was the major dynamic force of history.

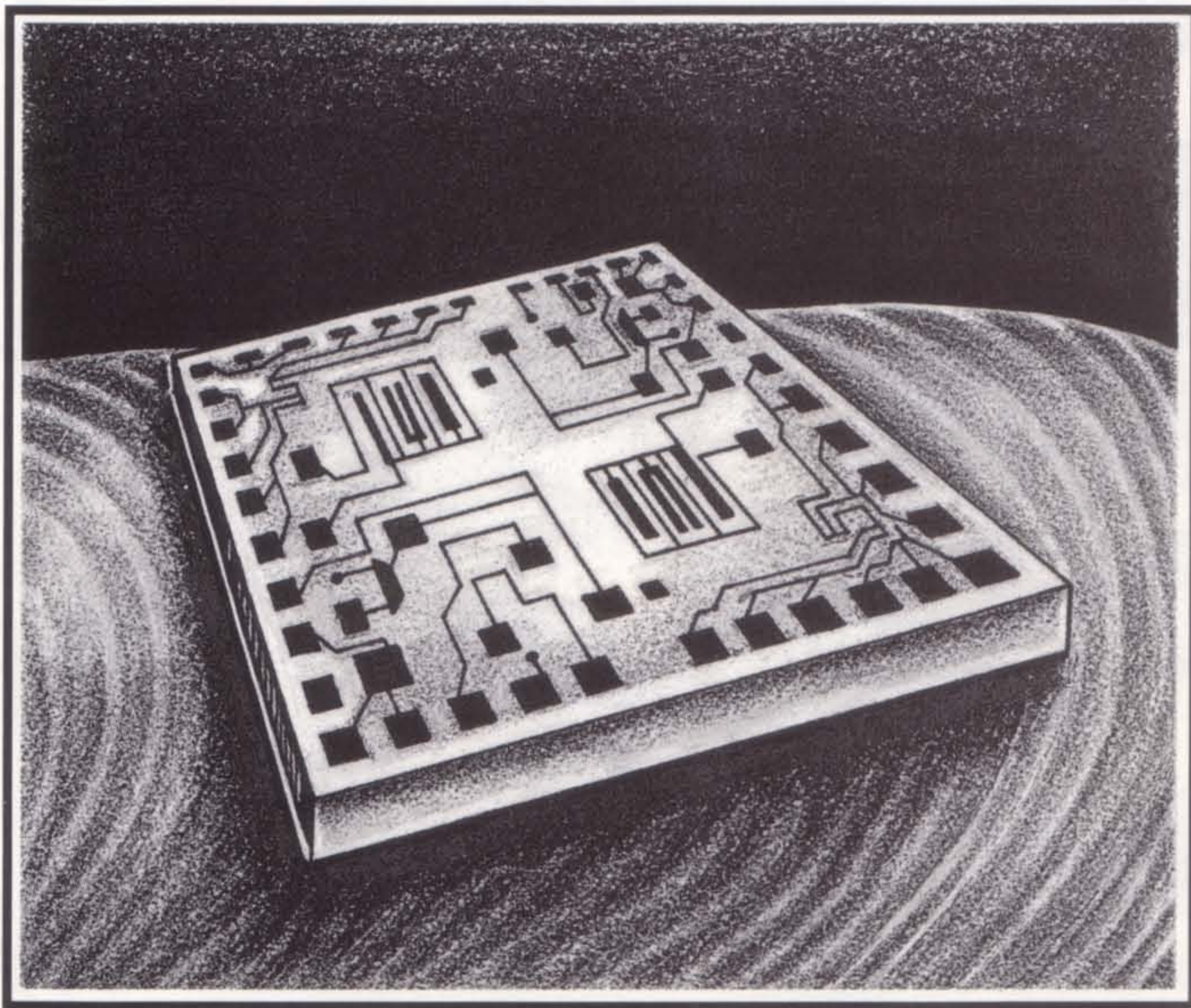

Silicon microprocessor computer chip

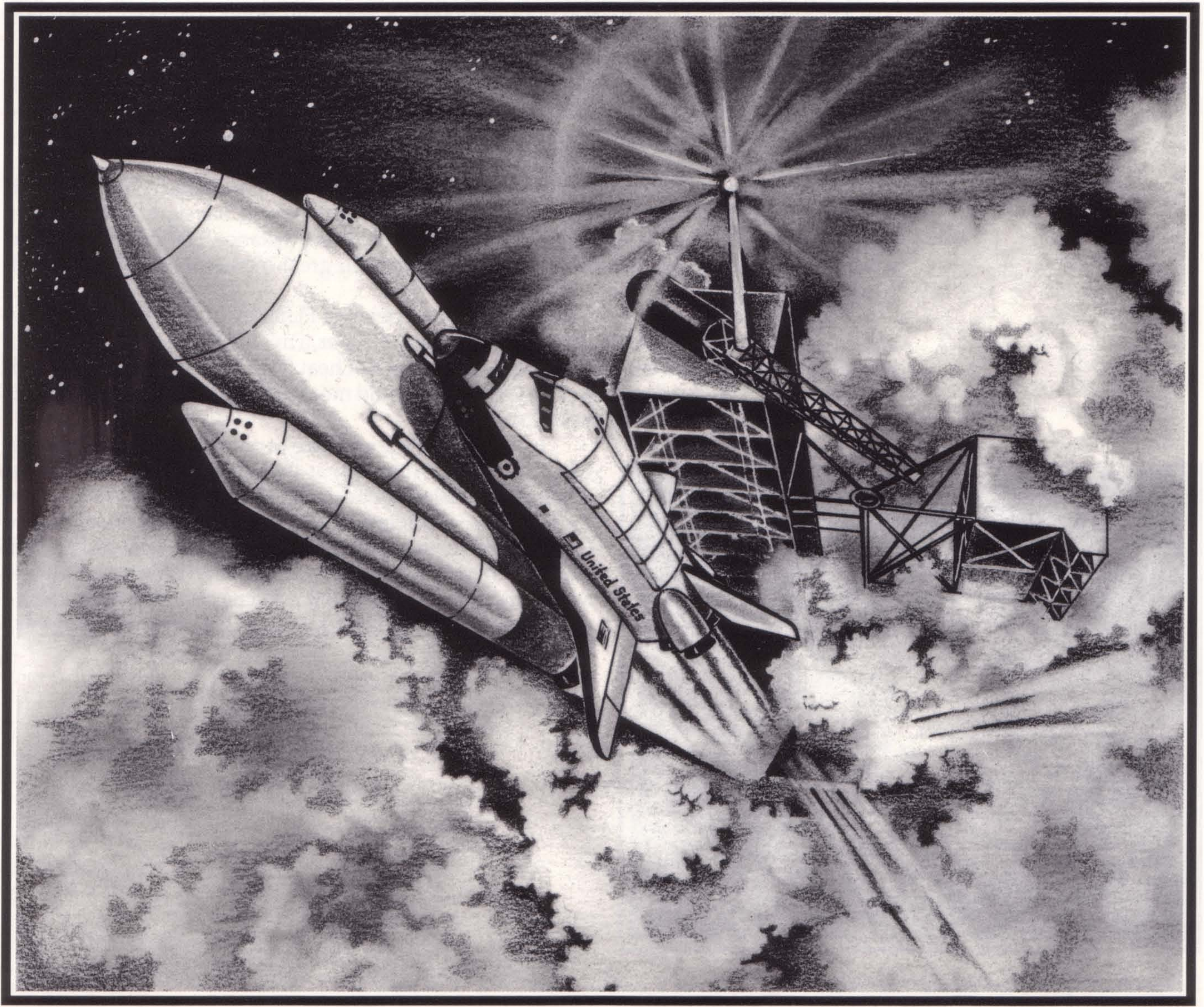

5. ADDITIONAL NOTES

LEADER BIOGRAPHIES

The civilizations that oppose you are ruled by well-known figures from history. For example, if you encounter the Greeks, they are ruled by Alexander the Great.

The strengths and weaknesses of the leader are reflected in how that person manages his or her civilization. Alexander, who conquered most of the known world in his time, may be expected to be similarly aggressive if he appears as one of your rivals. Each rival leader in *Civilization* is rated in three categories: Aggression, Development, and Militarism. Within each category there is a scale of behavior. The leader may be at one end or the other, or neutral.

Aggression: This measures how likely the leader is to go to war with his neighbors. *Aggressive* leaders are likely to choose war even when involved in several wars already. *Friendly* leaders are likely to make peace even when not at war elsewhere.

Development: *Expansionist* leaders are interested in expanding the size of their civilizations and devote resources to building Settlers and sending them out to found new cities. *Perfectionist* leaders, the other end of the scale, are more interested in building up individual cities and improving the terrain around them. While they do expand, they do so at a much less reduced rate than their opposites.

Militarism: *Militaristic* leaders seek to acquire technology that leads to better weapons. *Civilized* leaders seek technologies that are most useful in improving their civilization economically and politically.

You can learn about the personality of a leader of any civilization with which you have established an embassy from the report of your Intelligence Advisor. Press the Info button for the civilization and look under the leader's name. Listed there are the personality characteristics of the leader. For any category that is not mentioned the leader is neutral. For example, Elizabeth I is listed only as Expansionist. That indicates she is neutral regarding Aggression and Militarism. Be aware that these personality traits are only tendencies and that all leaders are capable of any type of action, depending on circumstances.

Religion (Philosophy & Writing)

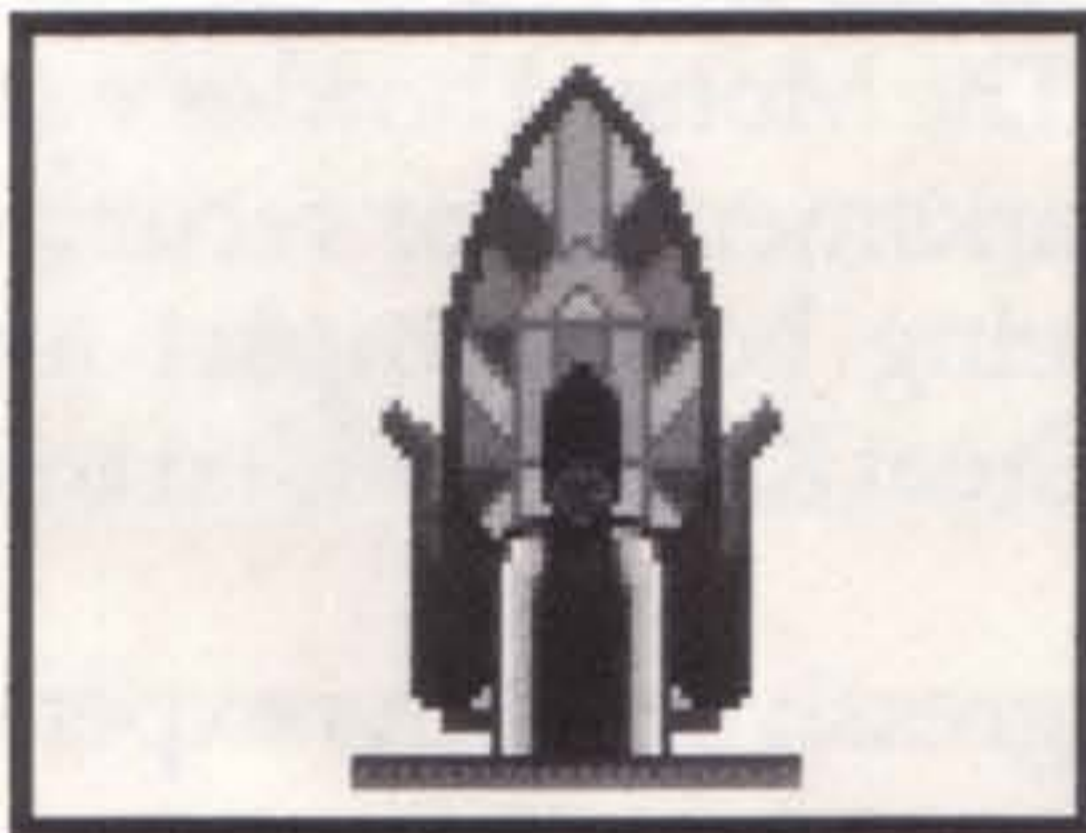

Cathedral



J. S. Bach's Cathedral



Michelangelo's Chapel

The leaders and civilizations that you may encounter are listed below. For each there is a brief biographical note and a hint or two on what to expect if you encounter them.

Abraham Lincoln (Americans): From humble beginnings, and largely self-taught, Lincoln rose to become one of America's greatest Presidents. Directing the nation through the Civil War, his will, intellect, and political skill were critical for the survival of the fledgling democracy. Most often associated with the emancipation of slaves, the reunification of the country and the preservation of democracy are his lasting contributions.

In *Civilization*, Abraham Lincoln and the Americans are most likely to become a democracy. While they look to expand, they are not overly aggressive.

Alexander the Great (Greeks): Alexander inherited the throne of Macedonia in 336 B.C. and quickly gained control of all Greece. At the head of an allied Greek army, he set out on one of the greatest military campaigns of history. Within twelve years he had conquered the enormous Persian empire to the east, Egypt to the south, and the western part of modern India. Only the reluctance of his men to continue ended the conquests. He died prematurely of fever at the age of 33, but in this short span established himself as one of the greatest generals of all time.

If you encounter Alexander and the Greeks, they can be expected to expand aggressively.

Elizabeth I (English): Queen of England for 45 years, she inherited a strife-torn, failing nation, and built it into a first-rate European power. Her main adversaries were the Spanish under Philip II, who went into a steady decline after the defeat of their Armada in 1588. Elizabeth was known for important domestic reforms as well as shrewd diplomatic and military maneuvers. Her reign was marked by a general flowering of the English economy and culture. She presided over the beginnings of the British empire, not quite living to see the establishment of English colonies in North America.

Elizabeth is a formidable foe, aggressively expanding and competently growing at home.

Genghis Khan (Mongols): After uniting the Mongol tribes, he conquered the Chin Empire of northern China by 1215. For the next nine years his armies moved westward, overrunning all in their path and reaching well into eastern Europe. The Mongol hordes were armies of mounted bowmen who were outstanding riders and marksmen. Their recurved bow design was technologically ahead of Western weapons, being both compact and powerful. From his capital at Karakorum, south of Lake Baikal, the Great Khan presided over one of the largest land empires of history.

In *Civilization*, the Mongols can be expected to expand very aggressively at the expense of the development of individual cities.

Hammurabi (Babylonians): King of Babylonia, he is most noted for his code of laws, one of the earliest known. His empire encompassed the eastern part of the Fertile Crescent, centered on the Tigris and Euphrates Rivers. A competent ruler and builder of civilization, his empire was eventually destroyed by raids from Asia Minor.

The Babylonians are generally more concerned with building and growing, rather than continual expansion.

Robotics
(Plastics & Computers)

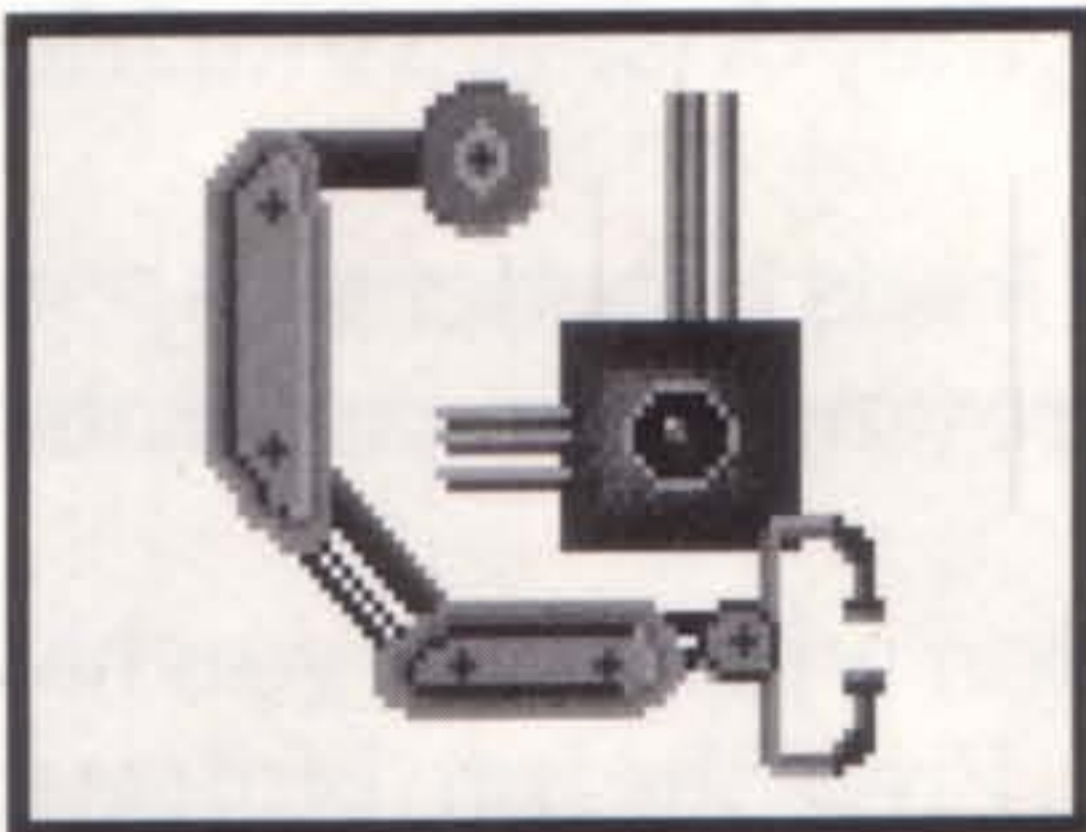

Artillery Unit



Mfg. Plant



Spaceship Module

Julius Caesar (Romans): One of the more controversial characters of history, Caesar was both a staunch defender of the people's rights and an ambitious politician who destroyed the Roman Republic. Certainly brilliant, among his other skills he was a superb general, conquering Gaul in a classic campaign that is still studied, invading Britain, and establishing himself as dictator for life after defeating Pompey in a civil war. Stabbed to death on the Ides of March (3/15) by friends and proteges who resented his grab for power, he nevertheless made the future Roman Empire possible.

The Romans are tough foes and can be expected to balance expansion, conquest, and development.

Mahatma Gandhi (Indians): The father of Indian independence, he was a skilled politician and spiritual leader. His campaign of passive resistance wore down the British and after World War II he was an important part of the independence negotiations. He worked tirelessly for an end to the caste system in India and for peaceful co-existence between the two great religious groups of the nation, the Hindus and the Muslims. He was fatally shot by a Hindu fanatic while on a prayer vigil for peace.

The Indians under Gandhi are not aggressively expansive and are more likely to develop the areas they can obtain peaceably. However, they are conscious of technology and can be a strong rival in a space race.

Mao Tse-tung (Chinese): Considered the founder of the People's Republic of China, he rose to power in the 1930s, leading the Long March and becoming head of the Chinese Communist party that eventually defeated the Nationalists. He led the new nation until 1958 when he was replaced due to the failure of many programs, including the Great Leap Forward, a plan to kick-start local industrial growth. He regained power after the disruption of the Cultural Revolution, a four-year period of unrest that he directed.

The Chinese are generally concerned with building a strong civilization and don't seek to expand aggressively.

Montezuma (Aztecs): The Aztec emperor at the time of the Spanish conquest, he was a brutal despot who angered his subject peoples. Cortez took advantage of this unpopularity, enlisting the aid of 30,000 Indian allies for the march on the Aztec capital. Montezuma's belief that the Spanish were the descendants of gods kept him from recognizing the danger and adequately preparing his formidable army.

The Aztecs are fierce warriors and dangerous opponents. They are quite capable of competent military campaigns while simultaneously building a strong empire.

Rocketry
(Advanced Flight &
Electronics)

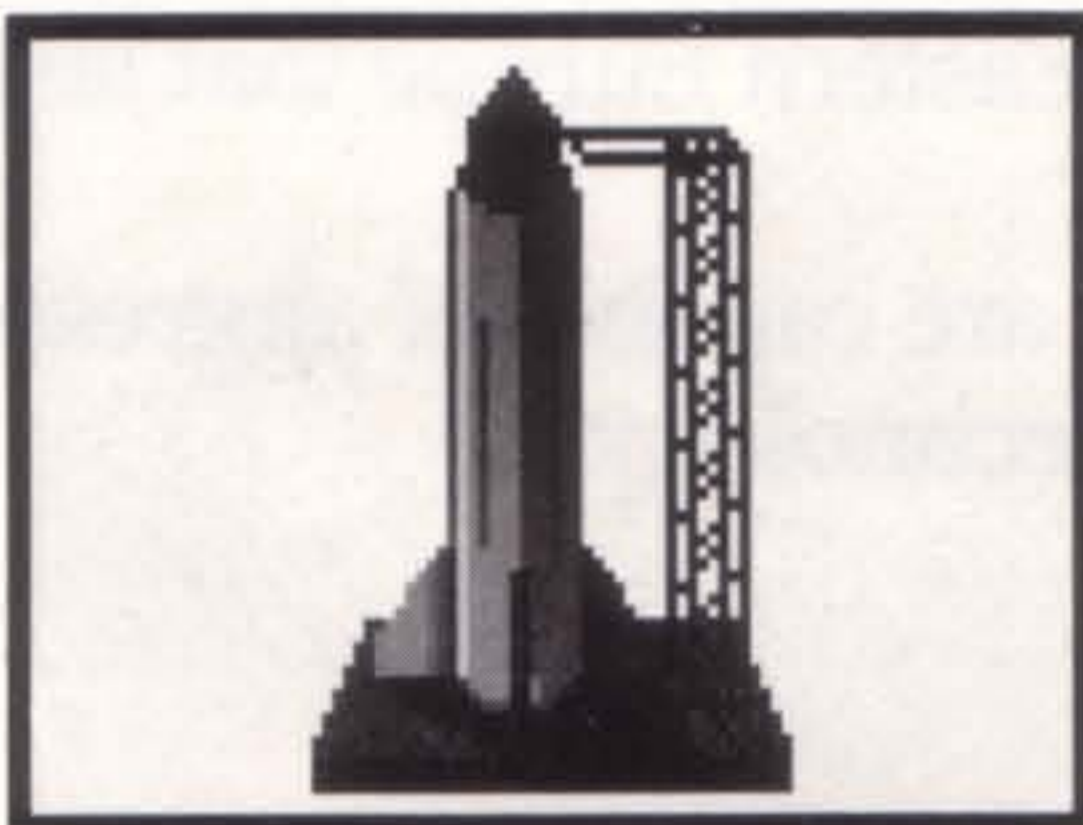

Nuclear Unit

Napoleon (French): Through bold and decisive action, Napoleon rose quickly during the turmoil of the French Revolution. He became part of the ruling Consulate that resulted from a Paris coup and thereafter consolidated power, eventually having himself crowned emperor in 1804. For the next 11 years Europe suffered almost constant war. At its peak the French Empire stretched from Madrid to Moscow. An allied coalition completed the defeat of the French at Waterloo and forced Napoleon into a final exile.

The French are conquerors and seek to expand. Perhaps not as dangerous as the Aztecs or Greeks, they are still a threat that must be watched.

Ramesses (Egyptians): Ramesses II ruled Egypt for 33 years after usurping the throne from his brother. Under his rule the empire blossomed, reaching from Syria to the fourth cataract of the Nile. He is noted for the splendor of the monuments, temples, and other buildings that he distributed liberally throughout the country. However, the rise of luxury, slavery, and mercenary armies during his reign fostered the indolence that led to the eventual decline of the Egyptian empire.

The Egyptians are great builders. Under Ramesses they can be expected to construct mighty cities and can be a significant threat if allowed to expand over a large area.

Shaka (Zulus): The first king of the Zulus, he united the tribal villages under his rule and forged the Zulu army. In a short period he conquered all nearby enemies and established Zululand. He and his descendants ruled uncontested until Europeans arrived on the border. Though the Zulus were without peer as individual warriors, they proved no match for well-led European armies with greatly superior weapons.

The Zulus are fierce warriors and are not afraid to pick a fight. Be wary if you discover them next door. They are not fascinated by technology and you may be able to gain a technological advantage over them.

Stalin (Russians): A long-time Bolshevik, he emerged from the power struggle following Lenin's death as the new leader of the Soviet Union, contrary to Lenin's wishes. He quickly implemented plans for the forced collectivization of agriculture, rapid industrialization, and a huge military buildup. These policies were made possible by a reign of state terror that led to millions of deaths. After repelling the Nazi invasion of World War II, which killed 20 million more Russians, he was able to establish a hegemony over most of Eastern Europe that lasted nearly half a century before disintegrating.

Under Stalin, the Russians are a dangerous opponent. They are capable of aggressive expansion, but may fall behind in the development of cities and technology.

Space Flight (Computers & Rocketry)



Spaceship Structural



Apollo Program

Sulayman (Turks): Sulayman I, known as The Magnificent, presided over the Ottoman Empire at its height. Continuing his father's campaigns, he conquered most of Hungary in the Balkans and the island of Rhodes in the Mediterranean. Fighting mainly against Venice and the Holy Roman Emperor Charles V, he just failed to take Venice and Malta, and lost Tunis. He also conquered much of Persia and Arabia. He was noted for the extent of his reforms, his patronage of the arts, and the splendor of his rule.

Under Sulayman, the Turks are very aggressive and a generally unpleasant neighbor. Keep a wary eye on them and don't hesitate if they let down their guard.

Steam Engine
(Physics & Invention)

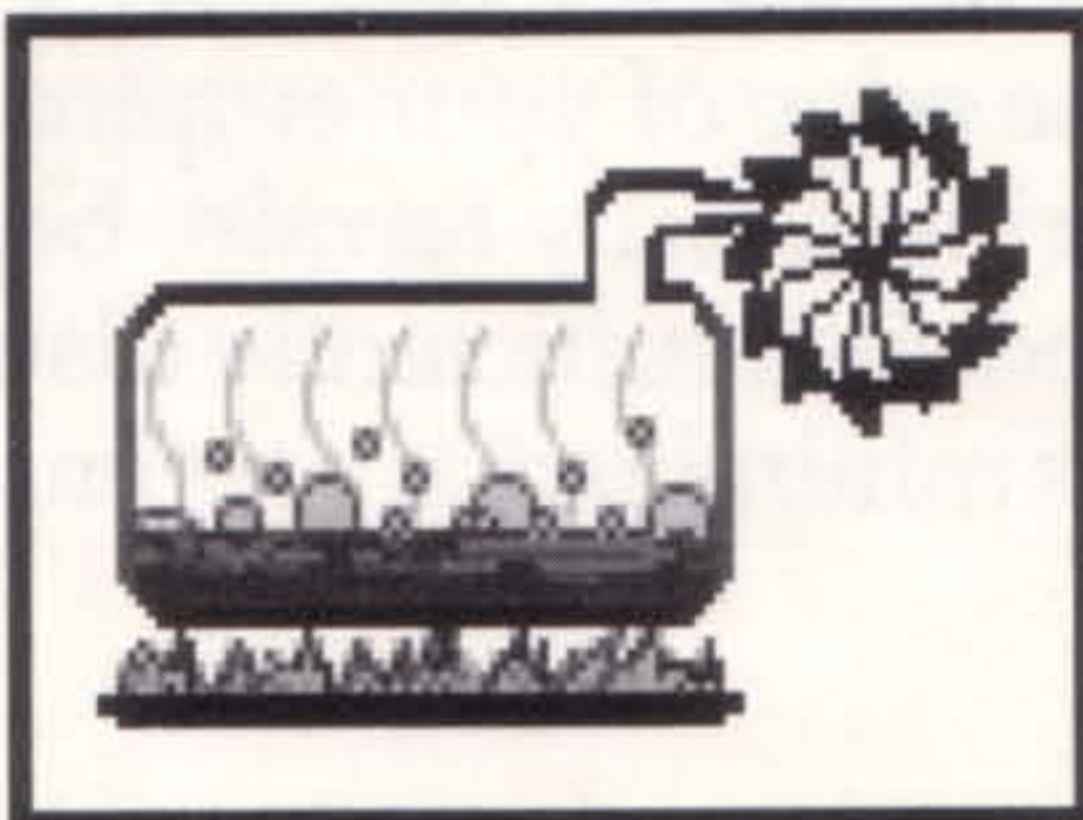

Ironclad Unit

PLAYERS' NOTES

It is recommended that new players start at the Chieftain level of difficulty. Move on to the higher levels after you have had some experience. The highest level of difficulty, Emperor level, is only for the most experienced players and those looking for a very tough challenge. Winning at this level is very difficult.

First City: Your first critical decision when starting a new game is selecting the site of your first city. The sooner the site is selected, the sooner you can begin the growth of your civilization. You should be able to find a reasonable site within the first several game turns. If you take too long you may fall significantly behind your rivals.

The best squares for placing a city are Grasslands that show the resource symbol, Plains, and River squares. However, only some River squares have resources. If you start a city on a River square that doesn't, the city's early development will be slowed. This means starting your first city on a River square is somewhat risky.

City site selection is interesting at the start because you know so little about the surrounding area. If the immediate vicinity looks reasonable for a start, it is usually best to accept the site you start on. A reasonable area for a start would include a nearby river, special resources like the Horse or Game, or Grasslands that show the resource symbol. Remember that Jungles and Swamps can eventually be cleared and converted into productive terrain. Starting next to an Ocean is good for allowing future ship construction.

A bad city area would include several Deserts and Mountains. While some Ocean, Forests, and Hills are desirable, too many of either restricts the growth potential of the city.

Defense of First City: The experience of our playtests indicate that it is most useful to build two Militia units immediately with your first city. When the first one appears, move it into the four adjacent map squares to the North, East, South, and West to discover the terrain your city can develop. Use this first Militia unit to further explore the nearby area. When the second Militia unit appears, fortify it in the city for defense.

A high priority thereafter, especially if you find or suspect nearby rivals, is to acquire Bronze Working so that at least one Phalanx unit can be put in the city for defense. Two Phalanxes are recommended for defense, especially in cities on the edge of your empire.

Expansion: After your first city is started and you are exploring nearby terrain, begin planning the placement of your next and future cities. Look for good sites sufficiently distant from your capital so that the overlap of areas that they can develop is minimized or prevented. This allows each to grow to its maximum.

Steel
(Metallurgy &
Industrialization)



Battleship Unit

Settlers are very important early on as they are needed to found new cities, build roads, and irrigate. Plains terrain is useful to irrigate under Despotism, and Grasslands and Rivers when you are about to change to a Monarchy. Most of your early cities should have a Settler in existence doing work of some kind. If it founds a new city, have the home city build another Settler. Granaries are very helpful for early cities because they allow them to produce more Settler units and still grow at a reasonable speed.

It is generally useful to expand as fast you can. Keep producing Settler units and send them to good city sites that your military units have discovered. A side benefit of expansion is that you push back the wilderness from which barbarians can appear.

Guns Versus Butter: Keep in mind that most of the great civilizations of history were built by military conquest, and that your rivals are going to be somewhat aggressive. You must be prepared at least for defense, if not conquest yourself.

It is possible to succeed as a relatively peaceful builder, but you will need to build up your economy with extensive trade routes and stay ahead in technology to discourage attack. Advance your government to Monarchy and Democracy as soon as you can.

Technology Priorities: Keep the Civilization Advances Chart (found at the back of this manual) handy. Examine this chart before playing and have some plans for which advances you wish your scientists to pursue. As time passes, the direction of your technology research may be adjusted according to strategic considerations. Each advance that can be studied at the start presents an opportunity and leads on to other useful knowledge.

Pottery makes the Granary improvement available and this speeds the growth of cities. Bronze Working introduces the Phalanx unit, which is good for city defense. Horseback Riding introduces Cavalry, which is a good offensive unit and useful in exploration because of its movement factor of 2. The Wheel introduces the Chariot, an excellent offensive unit with an attack factor of 4 that is useful if a rival is found nearby. Ceremonial Burial, the Alphabet, and Code of Laws are useful to quickly develop a more effective government.

If you find yourself on a small island or continent, acquiring Map Making will be useful because it allows construction of Triremes, the first ship units. If you are able to concentrate on economic development, acquiring Monarchy will allow you to change your government to one more favorable for growth. If war is likely, then the Wheel, Masonry (City Walls), and Mathematics (the Catapult) are useful. Writing introduces Diplomats, which are needed to establish embassies with rivals. Trade introduces the Caravan, which is economically important.

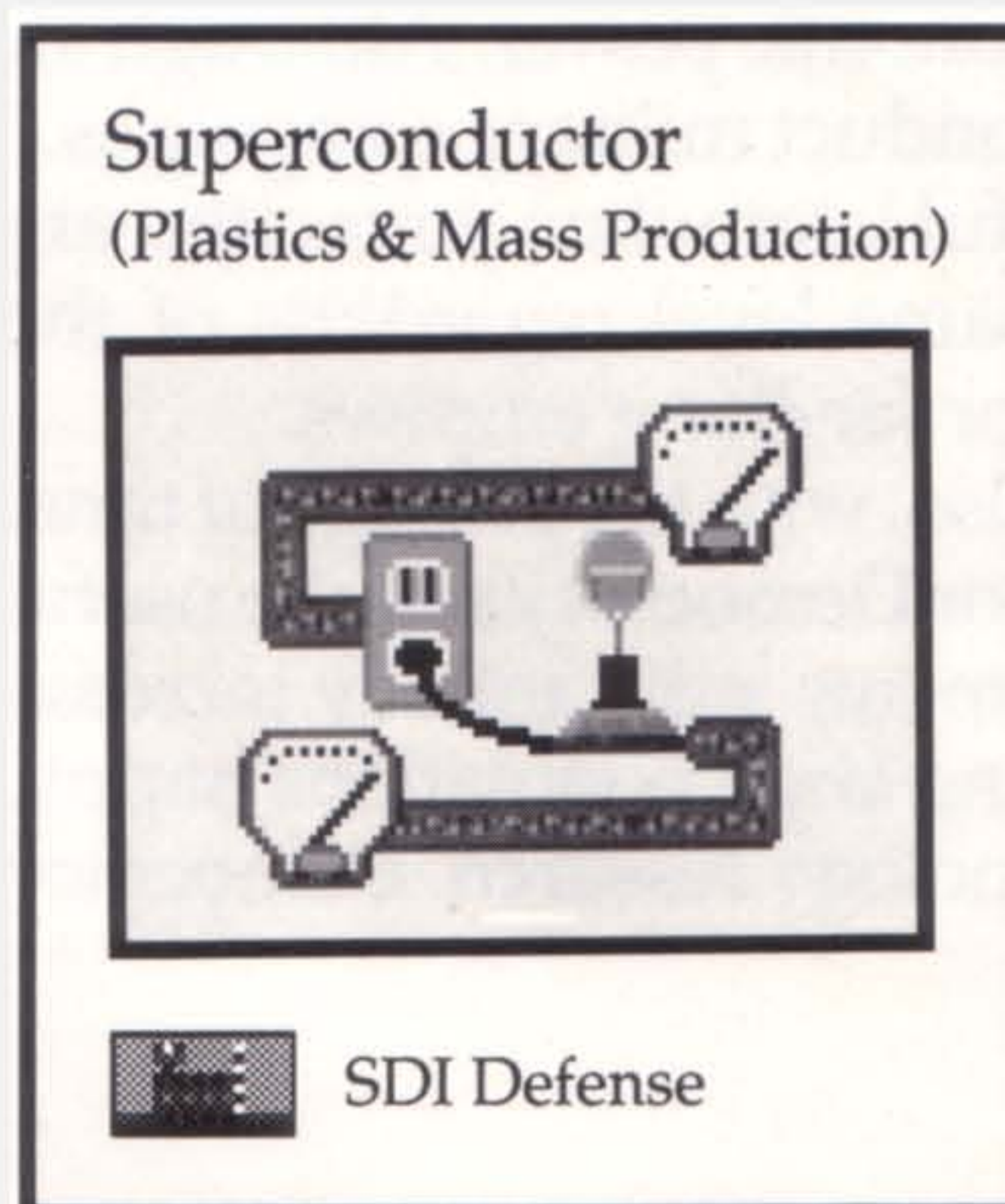

Wonders of the World: As you get more experienced with managing a civilization you will become more aware of how the various Wonders can be of benefit. Read through the descriptions of the Wonders and consider how each one may be useful. Some have economic benefits, some aid your diplomacy, and some speed the acquisition of technology. Attempt to build those that best suit your strategy. Keep in mind that the benefits of most of the early Wonders eventually expire.

Carefully consider when to build Wonders. There may be times when a Wonder would be useful, but other things such as Settlers, Aqueducts, or City Walls are more valuable for growth or defense. Wonders take a long time and many resources to build. Once construction of a Wonder has started, finish it as soon as possible so that a rival doesn't complete it first. Take advantage of the ability of Caravans to contribute to the construction of a Wonder.

Don't forget that the benefits of many Wonders accrue to the civilization that possesses it. It may be cheaper to capture an enemy city that has built a Wonder than to build it yourself.

Changing Governments: The ability to judge the best times to make changes of government will come with experience. The type of government that is most useful at any one time depends on your economic and strategic situation. Because changing governments throws you into anarchy and is thus costly, plan changes carefully.

Despotism is most useful during wartime and expansion (founding new cities), but can restrict the advance of technology and growth (populations). Because most existing units do not require resource support, new units, improvements, and Wonders can be built relatively quickly. Settler units only require one food unit, so each city can still support one or two that can be used to found new cities, build roads, irrigate farmland, and mine resources.

Once your cities have been spread out and are reaching a size of 7 or higher, consider switching to a Monarchy. This is most useful when you have irrigated Grasslands and Rivers because these areas now can produce 3 food units per square. This translates into faster growth and larger populations. This in turn generally means more trade, reasonable technology advance, greater resource production from mines, and more economic power. Although all units now require resource support, it is still very possible to conduct military campaigns.

Communism is similar to Monarchy but may be more useful later when your cities are larger. Because under Communism corruption stays at the same level regardless of the distance of cities from your capital, this government is useful for far-flung empires.

As your cities get larger, it is harder to keep them happy. Also, with the passage of time, each advance takes longer to acquire. Switching to the Republic or Democracy may be useful after your cities grow beyond 10 people because these governments substantially increase trade. The increased trade converts into more luxuries for making large populations happy, more taxes for maintaining city improvements, and more technology research. Democracy eliminates corruption, further increasing the benefits of trade.

The Corporation
(Banking & Industrialization)

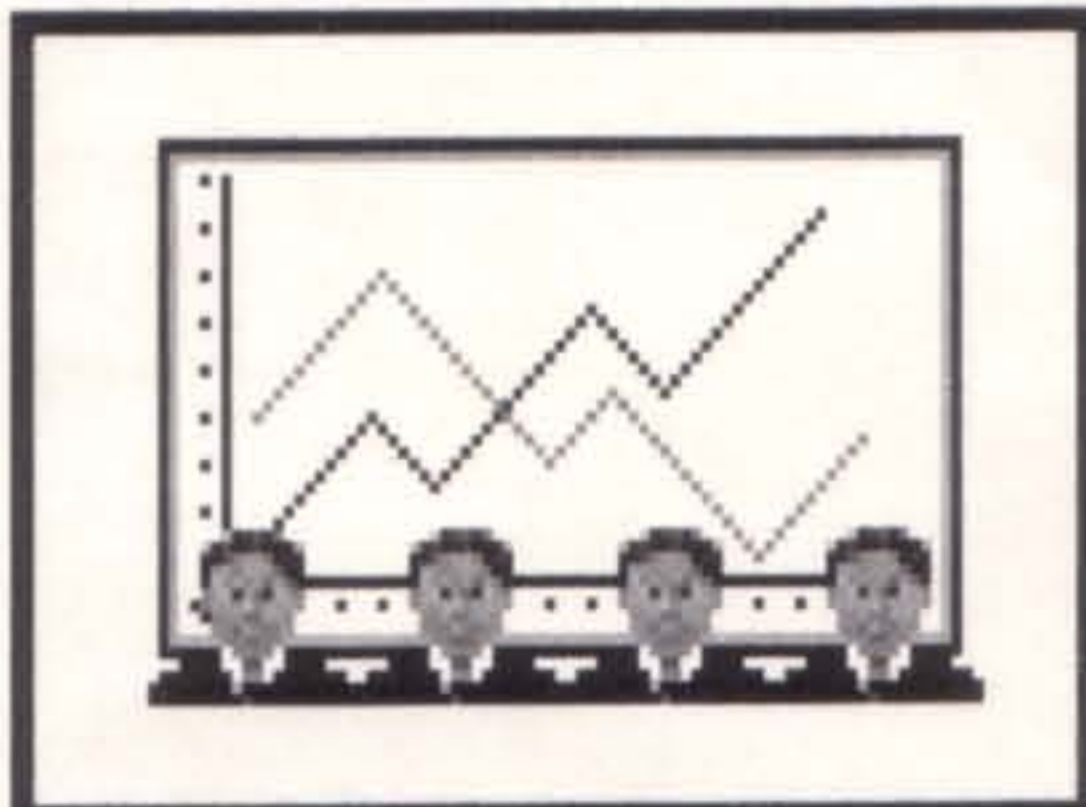

The trade-off is that war is difficult to conduct as a Republic or Democracy because each unit away from its home city creates one unhappy citizen. This makes it very difficult to conduct large military campaigns. Democracy or the Republic may not be a good choice if you are fighting or planning a major war.

War Versus Peace: Long and costly wars can significantly slow your growth, but wars can also be very useful for hampering rivals, capturing cities, and devastating enemy economies. Although war is often forced upon you, there will be many opportunities to make war as you choose. When to go to war depends on your strength, your enemy's strength, the threat an enemy poses, the desire to contain an enemy's expansion, and where you stand in technology. Prepare for war as much as you can before attacking, and attempt to achieve your goals quickly.

A technological advantage is quite useful in war, but only if you have built the better units and brought them to bear. You may encounter rivals who have a lead in technology but have built only a few units. Because they have concentrated on advancing, they may not be prepared for war. Technological advantage is especially useful at sea, because having better units there makes it easier to sink enemy transports that are often loaded with additional units.

If you are not prepared for war when an enemy appears on your frontier, it is often best to meet demands for technology or tribute, at least temporarily, so that you can move forces to the threatened area. Be wary of accepting large bribes to enter a war that you are not prepared for.

Once you have established a strong economy and identified your major rivals, it is often useful to stay at war with them until they are destroyed or ruined, or peace is forced on you by your Senate. While at war, restrict the movement of enemy transport ships, sinking all you can. In addition, wage economic war by landing units to pillage irrigation and mines to slow enemy growth and production.

It can be very difficult to capture cities that are well-defended behind City Walls. Diplomats sent into the city on a sabotage mission may get lucky and destroy the walls, making the attack easier. Also, Bomber and Artillery units ignore City Walls. Battleships and Bombers are useful for destroying defenders inside coastal cities that may thereafter be captured by invasion.

The Republic
(Code of Laws & Literacy)



A Strong Economy: As your civilization matures and your cities grow, it becomes increasingly more difficult to generate the money needed to maintain improvements and the luxuries the larger populations demand to stay happy. Large quantities of money and luxuries, as well as the scientific research that must continue, can be generated by large amounts of trade, city improvements, and Specialists.

The best way to improve the strength of your economy is to increase trade by establishing trade routes with large cities of other civilizations. You should attempt to establish the maximum three trade routes allowed for each of your larger (10+) cities. It is nearly impossible to build a strong economy without extensive trade routes. At the local level, you can put Ocean, Gem, or Gold Mine squares in development on a city map to increase trade. This normally means, however, that people are not at work elsewhere generating food and resources.

City improvements are useful for increasing taxes (Marketplaces and Banks) and research (Libraries and Universities). Taxes may also be increased by Taxmen. Science may be increased by Scientists.

Diplomats: New players may tend to overlook these units but more experienced players will come to recognize their value. You should attempt to establish an embassy with each of your opponents as you encounter them. This is the major value of Diplomats. It will help you plan your diplomacy and strategy by revealing the power of rivals. Diplomats can also be useful for looking inside enemy cities that you may attack and for their other abilities described in the manual.

Take every opportunity to destroy rival Diplomats. This can prevent the theft of technology or other unpleasantness.

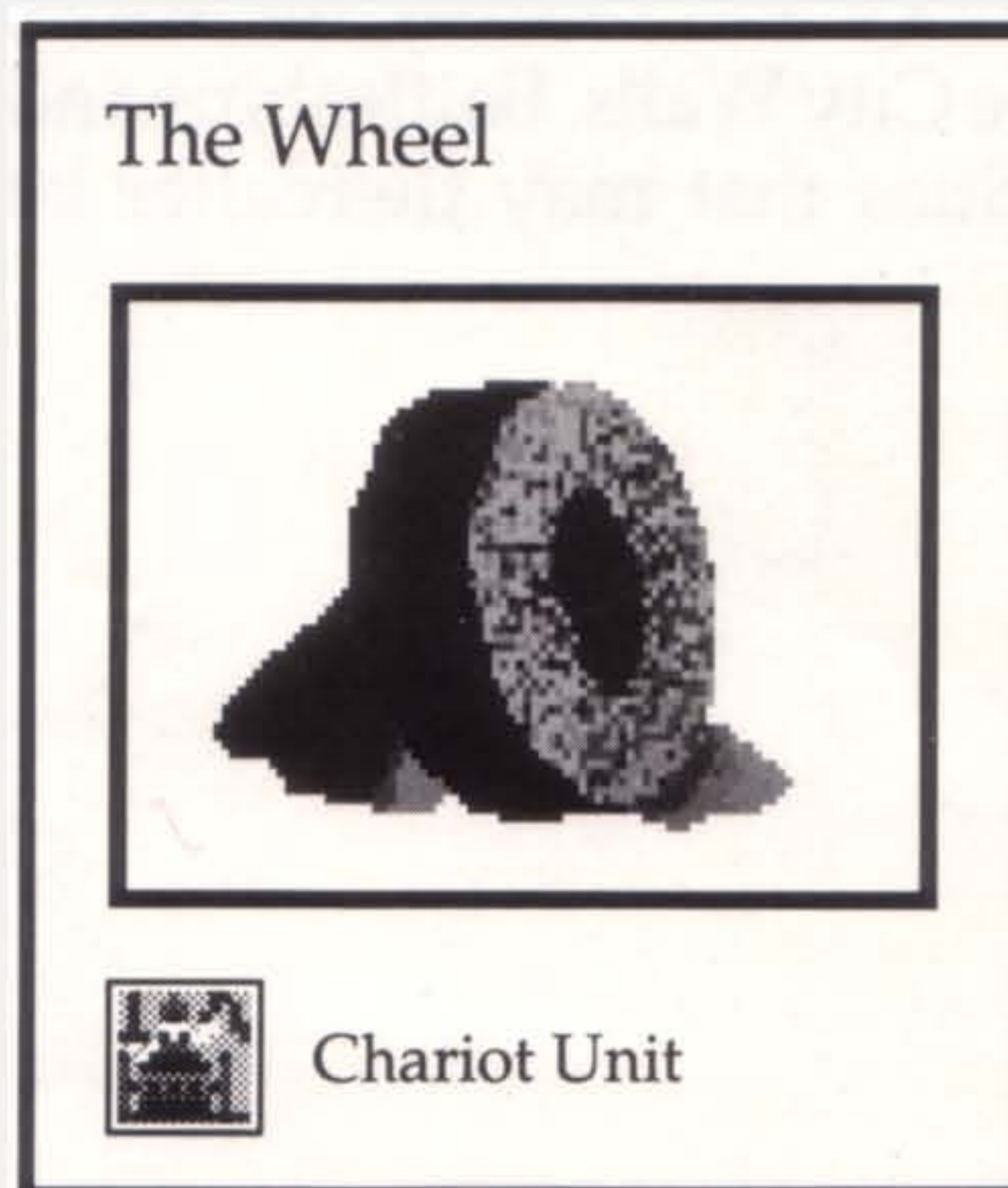

Variable Strategies: You must be prepared to tailor the strategy of your civilization to circumstances that arise. The two major options are peaceful economic development versus militaristic expansion. From the moment play begins, you will be gathering more information that helps plan your strategy. Important factors to be considered are the size of the island or continent that you first settle, the proximity of rivals, their strength, and their technological development.

If you begin isolated on a reasonably sized continent that can hold ten or so strong cities, then a strategy of economic development is promising. In this case look to change your government to Monarchy and then Democracy as soon as possible. If the continent is huge and inhabited by one or more rivals, then you must prepare for eventual war to ensure sufficient expansion. If you begin on a small island or continent, then prepare for expansion overseas.

When several rivals are found on the same continent, attempt to carve out as much of the territory as you can. Use Militia units to screen off enemy units and make peace with everyone, at least to start. Peace may allow you to trade for technology faster than you can otherwise obtain it. Establish embassies when you can and identify the neighbors you plan to destroy. Don't bother establishing trade routes with weaker neighbors that you plan to conquer.

When the time is right, attack and destroy one rival at a time. Be prepared ahead of time and attempt to end the war as soon as possible.

The suggestions listed above cover only a few highlights of tactics and strategies that were developed while *Civilization* was designed and tested. As you play, expect to discover many additional strategems that improve the success of your civilizations.

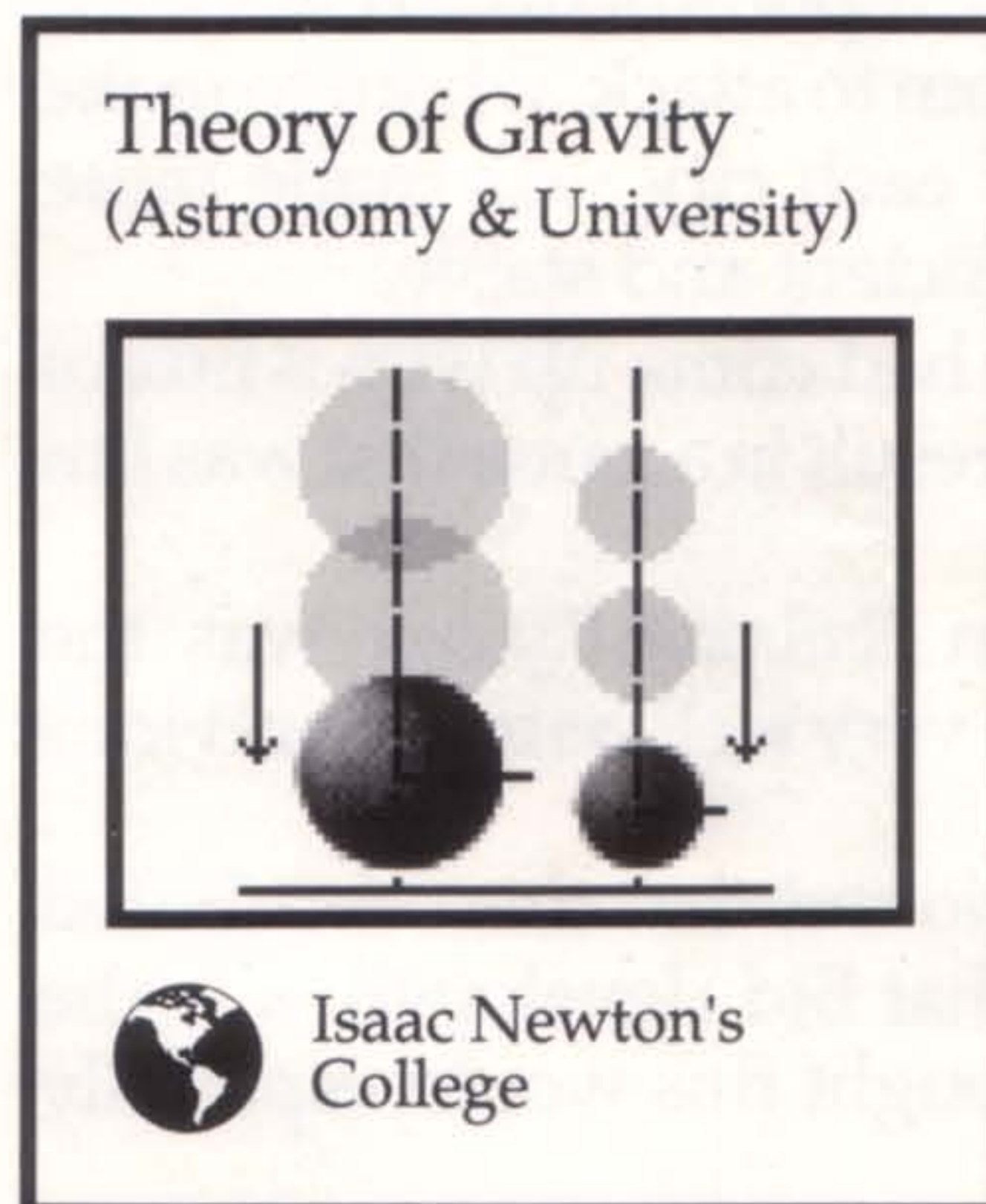

DESIGNERS' NOTES

The main inspiration for *Civilization* was the success and reception of *Railroad Tycoon*. We were very pleased with how *Railroad Tycoon* worked and began looking for a suitable topic to which we could apply some of its better concepts. Thinking back, we can't recall now what triggered the idea of making the new game about the history of civilization, but once the topic arose, it quickly became obvious that it fit our specifications.

The central concept to *Civilization* was that it was to be a "god game," casting the player as the hero and ruler of a civilization over the course of its history. In this role he would guide and build his civilization, watching it grow and expand, rise or fall. As play proceeded the player could see the results of his decisions unfold and success would hinge on his relative skill.

We also wanted *Civilization* to require the decision maker to juggle several balls at once. We found in *Railroad Tycoon* that this helped keep the challenge and interest high. As Sid sketched out the basic design, he evolved the various hats the player would wear.

Clearly he would be the military commander, moving his armies against rivals. A second role was that of economic planner. Wearing this hat, the player would plan the placement, growth, and production of cities. The player would have to decide between "guns or butter," producing military hardware or economic enhancements for his civilization.

The player would also have to decide upon the direction of research for new knowledge. This again would often be a guns or butter decision, as some advances improved internal conditions and others made the military more potent. The player would have to judge which avenue of research was most useful at any one time, and be prepared to change if conditions warranted it.

As design work continued, additional player roles were added. He would have to conduct his own diplomacy. By keeping track of rivals through the reports of his advisors, the player would have to make judgments on whom to appease, whom to attack, whom to make friends, and whom to ignore. In addition, the management of each city was made more complex, forcing the player to spend more time to keep them efficient and stable.

With all of these duties falling to the player, we felt that we had come up with a mix of interesting decisions that would keep the player challenged, and result in a game that was fun and addictive.

Another major concept that we wanted to borrow from *Railroad Tycoon* was the variability of worlds that made every game different. This worked very well, as in the previous game, making the play fresh each time.

We also decided early on to include the hidden map. We found that this contributed significantly to the fun and interest of play. Another feature that Sid developed was the Civilopedia, the on-line encyclopedia of game concepts. We thought this would especially help new players.

Trade
(Currency & Code of Laws)

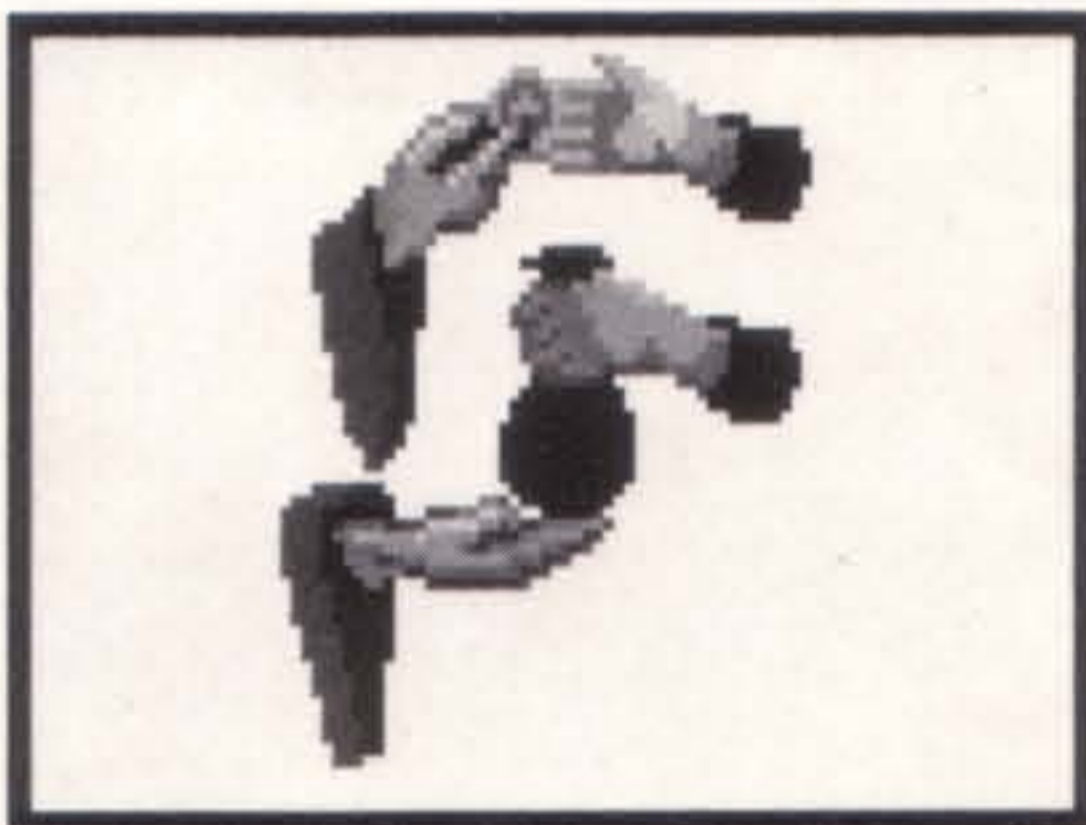

Caravan Unit

Most of these game features were in place in a rough form by the end of the winter of 1990-1991. Thereafter work proceeded mainly by the trial and error process of coding, testing, reviewing, and re-coding. Through the spring and summer a new version appeared every day or so, and the design became more refined. We made adjustments in the list of technology advances, we juggled their relationships, we made changes in the types and values of military units, we adjusted the time length of turns, we curbed the danger presented by barbarians, and, most critically, we continually improved the artificial intelligence of the rival civilizations.

Among the interesting features that didn't make the final cuts were ocean minefields that could be laid by Ironclads; alcoholic beverages (proposed by some as a major impetus for the first permanent settlements); Solar Power Plants; Fighter-Bombers 8-8-8(32); the Super Highways Wonder that speeded road building; Charlemagne, king of the Franks; and a much more detailed spaceship.

The most important feature that went in as the game neared completion was the concept of trade routes established by Caravans. This helped with the generation of knowledge and the establishment of strong economies. It also encouraged exploration and diplomacy.

Also important was the home city concept, especially under the Republic or Democracy. Originally, military units cost \$2 maintenance each under these governments, then only \$1 if they were fortified or on sentry duty. When military units caused unhappiness instead, this seemed to work more as one would expect. It became more difficult to wage war under these governments and provided an interesting trade-off for the improved economic performance.

The last major feature to be included was the Space Race. We had tossed around several ideas for ending the game but eventually returned to space, one of the earliest ideas. Reaching another planet with colonists from Earth made an excellent culmination for the history of humankind on our planet.

Like *Railroad Tycoon*, *Civilization* has been a great project to work on. In fact, important work has often been delayed because it was so much fun to play. *Civilization* has proven to be extraordinarily popular with our colleagues here at MPS Labs, and that's a good sign. With so many cool features and interesting decisions, plus an endless supply of new worlds, we are certain that *Civilization* is the last game you'll ever need. But, just in case you disagree, we'll start on something new as soon as this one goes out the door.

Sid Meier
Bruce Shelley
September 11, 1991

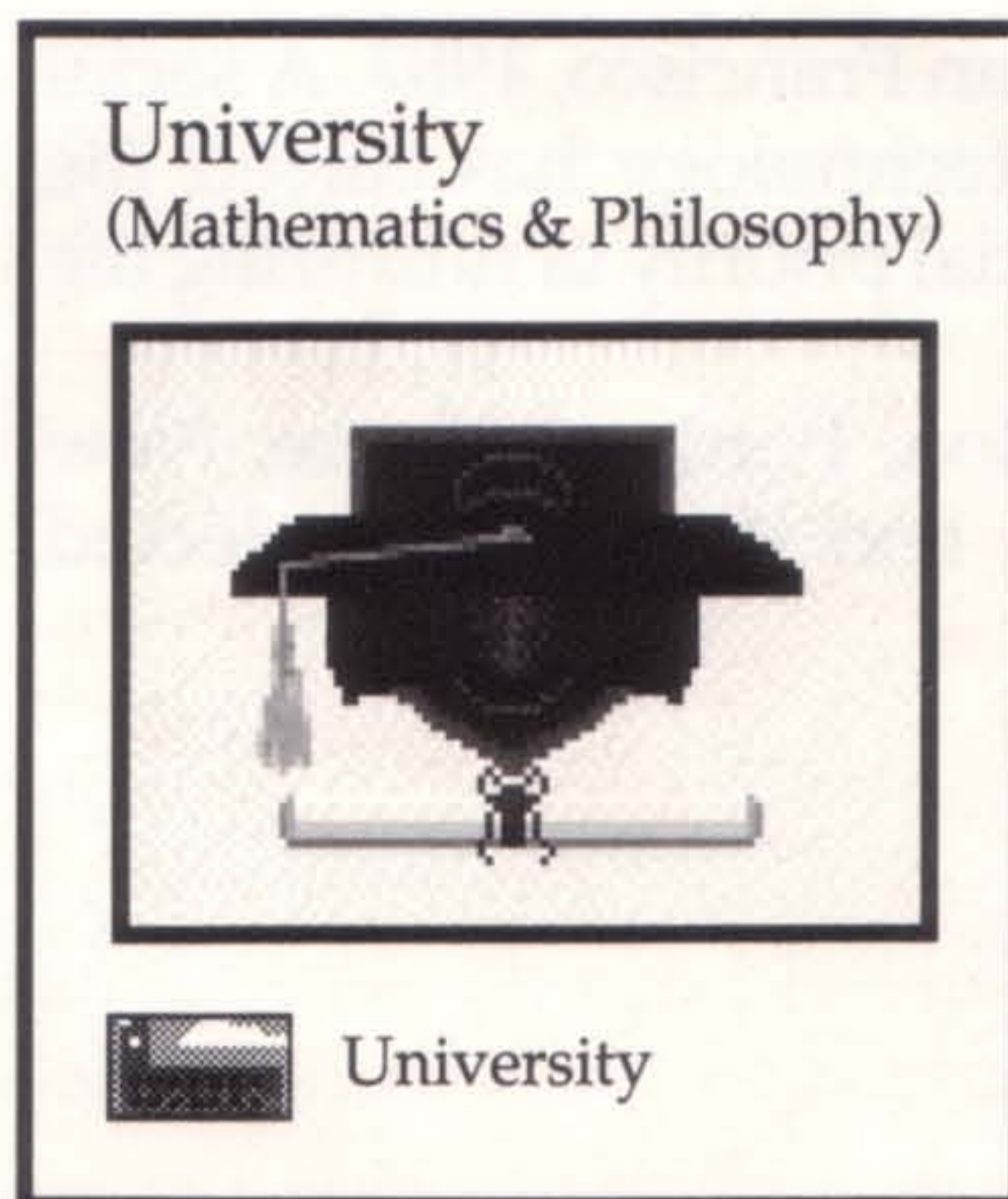

FURTHER READING

A wide variety of sources were consulted for this game. Among the many books examined, the following were found especially interesting and are recommended for further reading:

A History of Scientific Ideas, by Charles Singer, Dorset Press, New York, 1990. Originally published as a history of scientific ideas up to 1900, this book is informative and thought provoking.

Atlas of World History, edited by R. I. Moore, Rand McNally, New York, 1987. Fascinating maps combined with an informative text.

Man, God, and Civilization, by John G. Jackson, Citadel Press, New York, 1990. An alternative view that proposes not only humans but civilization also arose in Africa; not convincing.

Our Oriental Heritage, The History of Civilization, Volume 1, Will Durant, Simon & Schuster, New York, 1935, 1963. This first volume of Durant's history discusses the definition and beginnings of civilization.

The Ancient Engineers, by L. Sprague De Camp, Dorset Press, New York, 1990. Originally published in 1960, this remains an entertaining discussion of early engineering and the history of invention.

The Rise and Fall of the Great Powers, Paul Kennedy, Random House, New York, 1987. Economic change and military conflict from 1500 to 2000; recommended by MicroProse colleague Sandy Petersen as the best non-fiction book published in the 1980s.

The Seven Wonders of the Ancient World, edited by Peter Clayton & Martin Price, Dorset, New York, 1989. The stories of these famous monuments, only one of which still exists.

The Times Atlas of World History, Revised Edition, edited by Geoffrey Barraclough, Times Books, London, 1985. Great maps; a game on every page.

The Blade and the Chalice, Riane Eisler, Harper & Row, San Francisco, 1987. A social organization of male domination, hierarchy, and destructive technology has cursed the evolution of society; a return to partnership of the sexes and a social priority of nurturing life is the hope of humankind.

The World Atlas of Archaeology, edited by Christine Flon, Portland House, New York, 1985. Beautiful maps and photographs accompany text describing selected archaeological sites.

Writing
(Alphabet)



Diplomat Unit



Library

INDEX

Activating units	34	Famine	88
Advisors	46	Find city	29, 30
Animations	30	Fire	88
Attitude Advisor	47	Flood	88
Autosave	30	Food	9, 70, 73
Barbarians	42	Fortified	35
Bribing enemy units	75	Fortress	35, 37
Caravans	11, 39, 118	Futuristic advances	48, 49
Cities	9, 61	Game menu	29, 30
City display	68	Global warming	53
City improvements	74, 78	Go To orders	36
City management	63	Government	43
City map	69	Government effects	43, 66, 70, 75, 77
City protection	65	Government types	43
City radius	62	Government- changing	45, 118
City sites	62, 116	Hall of Fame	16, 23
City status report	46	Happiness	66, 71, 75, 76
Civil disorder	18, 66	Home city	36, 75
Civilization advances	31, 51	Information window	75
Civilization Score	23, 49	Instant advice	30
Civilopedia	51	Intelligence Advisor	47
Colonists bonus	23, 49	Irrigation	37, 63
Combat	19, 35	Leader biographies	111
Corruption	71	Luxuries	66, 71
Customized worlds	16	Maintenance - improvements	19, 47, 78
Demographics	50	Maintenance - units	70, 75
Designers' notes	122	Map display	28
Difficulty levels	16	Martial law	66, 77
Diplomacy	55	Menu bar	29
Diplomats	11, 37, 119, 120	Military Advisor	46
Disasters	18, 78, 88	Military units	40
Disband orders	36	Mining	37, 63
Earthquakes	88	Minor tribes	27, 62
Embassies	38, 47	Movement of units	19, 33
End of turn	20, 30	Movement restrictions	34
Entertainers	71, 72	Naval transport	34, 41, 42
Exchanging technology	55	Nuclear meltdown	54

Nuclear weapons	36, 41, 54
Orders	29, 36
Palace	20
Palace window	20
Peace	56
Pillage orders	36
Piracy	88
Plague	88
Players' notes	116
Pollution - causes	52, 54
Pollution - effects	52
Pollution- nuclear meltdown	54
Pollution- nuclear weapons	53
Population Happiness Chart	76
Pre-game options	16
Production	64, 73
Railroads	32, 37, 65
Resources	10, 70, 73
Revolt	38
Revolution	30, 45
Roads	32, 37, 65
Rush job	74
Sabotage	78
Science/technology	10, 31, 71
Science advisor	48
Scientists	64, 71, 72
Selling city improvements	78
Sentry duty	36
Settlers	25, 37, 117
Shore bombardment	36
Shortcut keys	14
Spaceships	57
Spaceship components	58
Spaceship launches	58
Spaceship modules	59
Spaceship structures	59
Specialists	66, 72, 77
Special resources	27, 62
Status report	31

Tax revenue	64, 66, 71
Taxmen	71, 72
Technology research	19, 64, 117
Terrain types	26
Top 5 Cities	49
Trade	10, 69, 70
Trade Advisor	47
Trade rates	30, 31
Trade routes	39, 120
Veteran units	35
Volcanos	88
"We love the (king) day"	66, 70
Wonders of the World	82, 118
World Map	49, 76

COPYRIGHT NOTICE

Copyright ©1991 by MicroProse Software, Inc.,
all rights reserved.

This manual and the computer programs and audiovisuals on the accompanying floppy disks, which are described by this manual, are copyrighted and contain proprietary information belonging to MicroProse Software, Inc. No one may give or sell copies of this manual or the accompanying disks or of listings of the programs on the disks to any person or institution, except as provided for by written agreement with MicroProse Software, Inc. No one may copy, photocopy, reproduce, translate this manual or reduce it to machine readable form, in whole or in part, without the prior written consent of MicroProse Software, Inc. Any person/persons reproducing any portion of this program, in any media, for any reason, shall be guilty of Copyright Violation, and shall be subject to civil liability at the discretion of the copyright holder.

LIMITED WARRANTY

Neither MICROPROSE SOFTWARE, INC., nor any dealer or distributor makes any warranty, express or implied, with respect to this manual, the disk or any related item, their quality, performance, merchantability, or fitness for any purpose. It is the responsibility solely of the purchaser to determine the suitability of the products for any purpose. Some states do not allow limitations on implied warranties or how long an implied warranty lasts, so the above limitation may not apply to you.

As a condition precedent to the warranty coverage provided below and to ensure identification, the original purchaser must complete and mail to MicroProse Software, Inc., 180 Lakefront Drive, Hunt Valley, Maryland 21030, within 30 days after purchase, the Registration/Warranty card enclosed in this product. To the original purchaser only, MicroProse Software, Inc. warrants the media to be free from defects in material for 90 days. If during the first 90 days after purchase a defect in media should occur, the software may be returned to MicroProse Software, Inc., who will replace the media at no charge. If at any time after the initial 90 day period your media becomes defective, the media may be returned to MicroProse Software for replacement at a reasonable service charge.

In no case will MicroProse Software, Inc. be held liable for direct, indirect or incidental damages resulting from any defect or omission in the manual, or other related items and processes, including, but not limited to, any interruption of service, loss of business, anticipated profit, or other consequential damages. Some states do not allow the exclusion or limitation of incidental or consequential damages, so the above limitation or exclusion may not apply to you.

This warranty gives you specific legal rights, and you may also have other rights which vary from state to state.

IMPORTANT: The above warranty does not apply if the you make any unauthorized attempt to modify or duplicate the product, or if the product has been damaged by accident or abuse.

MICROPROSE

Entertainment • Software

180 Lakefront Drive, Hunt Valley, Maryland, 21030
(301) 771-1151

CIVILIZATION™ ADVANCES CHART

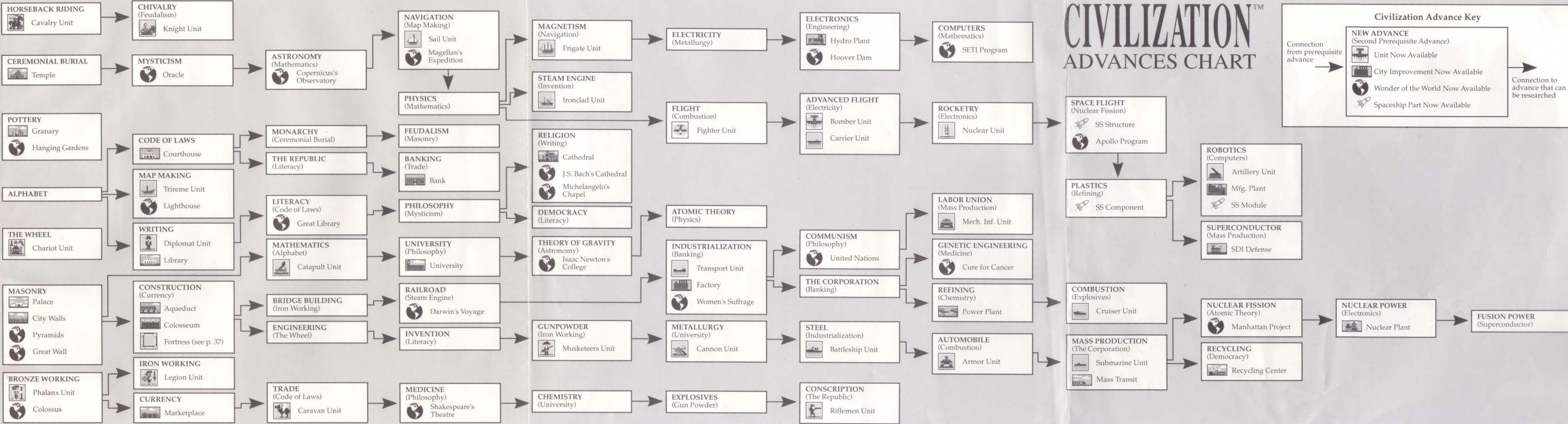

Unit 1, Hampton Road Industrial Estate,
Tetbury, Glos. GL8 8DA. Tel: (0666) 504 326