

ATARI[®] 5200[™]

STAR RAIDERS[™]

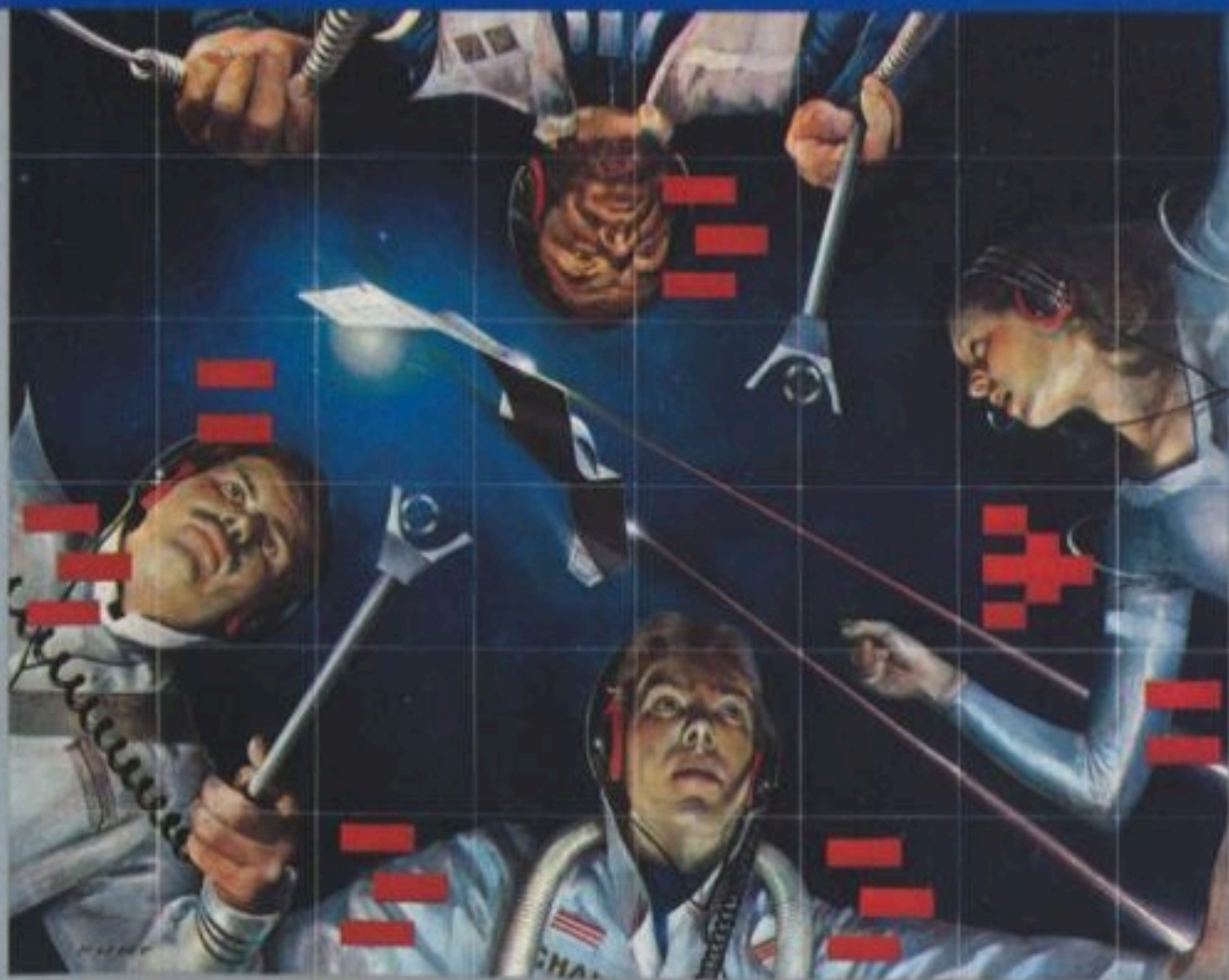

INSERTING THE GAME CARTRIDGE

To insert your ATARI 5200 game cartridge, hold the cartridge so the name on the label faces you and reads right-side-up. Carefully insert the cartridge into the slot in the center of the console. Be sure the cartridge is firmly seated, but do not force it. The **POWER ON/OFF** switch is located on the lower right side of the ATARI 5200. Press this switch to turn the power on **after** inserting your game cartridge. *See your Owner's Manual for further information.*



TABLE OF CONTENTS

1. A Word From Commander Champlon	1
2. Your Flight Simulation Training	5
3. Using the 5200™ Controller	9
4. Speed Mode	12
5. Control Mode	13
6. Energy Drain	23
7. Starship Damage	25
8. Starbase Docking	27
9. Rating	29
10. Mission Skill Levels	30
11. Training Mission	31
12. Survival Tactics	33
13. Scorecard	35

OPERATION

1. A WORD FROM COMMANDER CHAMPION

Welcome, cadets, to Federation Field. I'm Commander Champion, your space flight instructor. You'll be stationed here for some intensive starship flight simulation and computer training. When you've successfully completed your training mission, you'll win your Novice star and a commission in the Earth Federation's most elite fighting unit ... the Star Raiders™.

We Star Raiders have a long, distinguished tradition of service to the Earth Federation and the Galaxy. Since the year 2010 we've policed the space routes, enforcing freedom of space and peaceful coexistence of the solar systems. Thanks to the Star Raiders, there hasn't been a major space war since then. Space trade flourishes and the Earth Federation prospers.

Now, just as we're beginning to think peace will put the Star Raiders out of business, the Zylons ... that rabble of half-life barbarians from Alpha Solar ... turn to space piracy and ter-

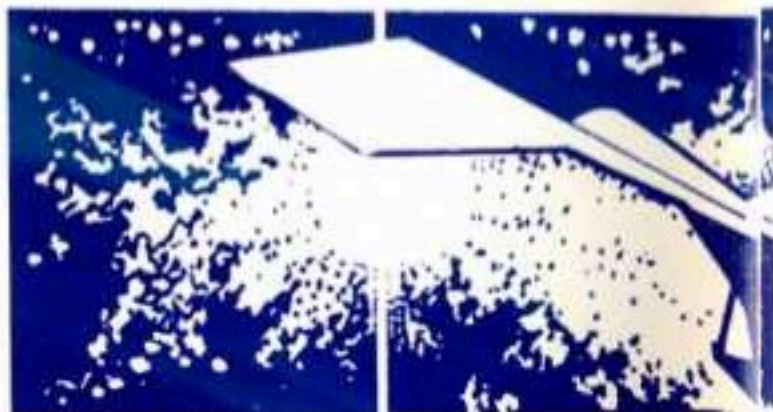

WIPEOUT!



rorism. Their object is to break up the Federation's space trade and weaken its influence in the Galaxy. Space Security has issued "cease and desist" orders to no avail. Zylon responds by hijacking our spacecraft and terrorizing starbases that harbor them. They've pushed us to the limit. Let's rid the Galaxy of this pest once and for all!

Your mission is to **SEEK OUT** Zylon combat ships in every sector of the Galaxy and **DESTROY THEM ON SIGHT**. For this job we've given you the ultimate in sophisticated fighter craft. Your starship is equipped with high-power photon torpedoes, twin ion engines, and dual hyperwarp engines that transport you instantly to the furthest reaches of the Galaxy.

Your computer instrumentation surpasses state-of-the-art. It includes a Galactic Chart with real-time updating, Long-Range Sector Scan for pinpoint targeting, and the most ad-

vanced Attack Computer ever devised for locking on the target and homing in for the kill.

How does your starship compare with Zylon spacecraft? So far, Space Intelligence has profiles of three Zylon combat spacecraft:

Zylon Fighter - Designed for high-speed attacks, these ships can be deadly at close range.

Zylon Cruisers - These are patrol ships and attack only in self-defense. But don't let their defensive posture fool you; they'll give you plenty of trouble.

Zylon Basestar - Like our starships, Zylon basestars are equipped with shields to deflect photon torpedoes and can only be destroyed at close range. These are probably the trickiest of the Zylon fighter craft. Approach them with extreme caution.

Code name for this operation is WIPEOUT. You'll be launched on your first WIPEOUT mission as soon as you win your Novice star. To complete your mission, you must destroy all Zylon targets.

In a pinch, you can dock at a friendly starbase to energize and repair your starship, but be prepared for trouble. Once



Zylon Fighter

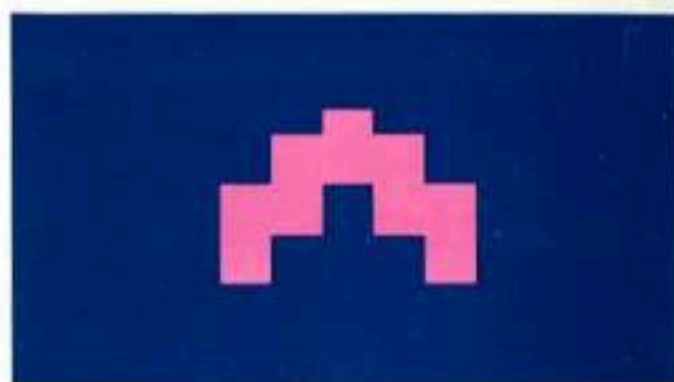

Zylon Cruisers



Zylon Basestar

WIPEOUT gets underway, we expect Zylon to surround and attempt to destroy all starbases that harbor our starships. Prevent this at all costs! Remember, with every starbase destroyed, our position in the Galaxy grows weaker and the Zylon menace grows stronger.

At the end of each mission, Mission Control will evaluate your performance and rate you on five factors:

- Skill level (NOVICE, PILOT, WARRIOR, COMMANDER).
- Number of enemy starships destroyed.
- Amount of energy used.
- Length of time taken to complete the mission.
- Number of starbases destroyed.

Promotions are based solely on ratings ... there are no shortcuts to success in the Star Raiders. You start as ROOKIES, but in no time at all you'll make ENSIGN and then PILOT. After that the going gets rough. Don't be surprised if your first Pilot mission ends with a demotion to GALACTIC COOK or GARBAGE SCOW CAPTAIN. This is a tough service! But you've got the stuff to make it. Some of you may even be WARRIOR material. We'll tell you if you are. As for STAR COMMANDER, few ever make it, but who knows? The next one might be you.

Go to it and good luck! Or as we say in the Star Raiders, "Shields up and lock on target."



Novice



Pilot



Warrior



Commander

2. YOUR FLIGHT SIMULATION TRAINING

Your flight training program teaches you how to pilot a starship, find and destroy the enemy, dock at a starbase to energize and repair your starship, and above all, survive in space. The training sessions are coordinated with your manual, so be sure you read it thoroughly, cover to cover.

In a minute I'm going to show you your starship simulation chamber and we'll "lift off" into space. Then you'll find out how to handle your 5200 controller, which controls every function of your starship (Section 3). I'll check you out on the Speed Mode and Control Mode push-button controls (Sections 4 and 5) and teach you to use the following starship equipment:

- Shields
- Attack Computer
- Galactic Chart
- Hyperwarp Engines
- Photon Torpedoes
- Control Panel Display
- Long-Range Sector Scan
- Manual Target Selector
- Tracking Computer
- Subspace Radio.

We'll discuss energy drain (Section 6) and what to do when your starship is damaged (Section 7). Then you'll practice docking at a starbase to

energize and repair your starship (Section 8).

I'll explain how Mission Control rates your performance at the end of each mission and decides what rank to promote (or demote) you to (Section 9). Next you'll get a briefing on what to expect at the four skill levels: NOVICE, PILOT, WARRIOR and COMMANDER (Section 10).

When you're ready for your first training mission, I'll give you step-by-step flight instructions (Section 11). To win your Novice star you must complete your training mission with energy to spare and earn a rank higher than ROOKIE.

After graduation, you will probably rise in rank pretty fast until you make PILOT. Then it gets rough. So be sure



you pay attention to the lectures on **SURVIVAL TACTICS** (Section 12). At the end of the manual we've provided a **SCORECARD** so you can keep track of your progress.

That's the program. Now follow me and I'll show you your star-ship simulator.



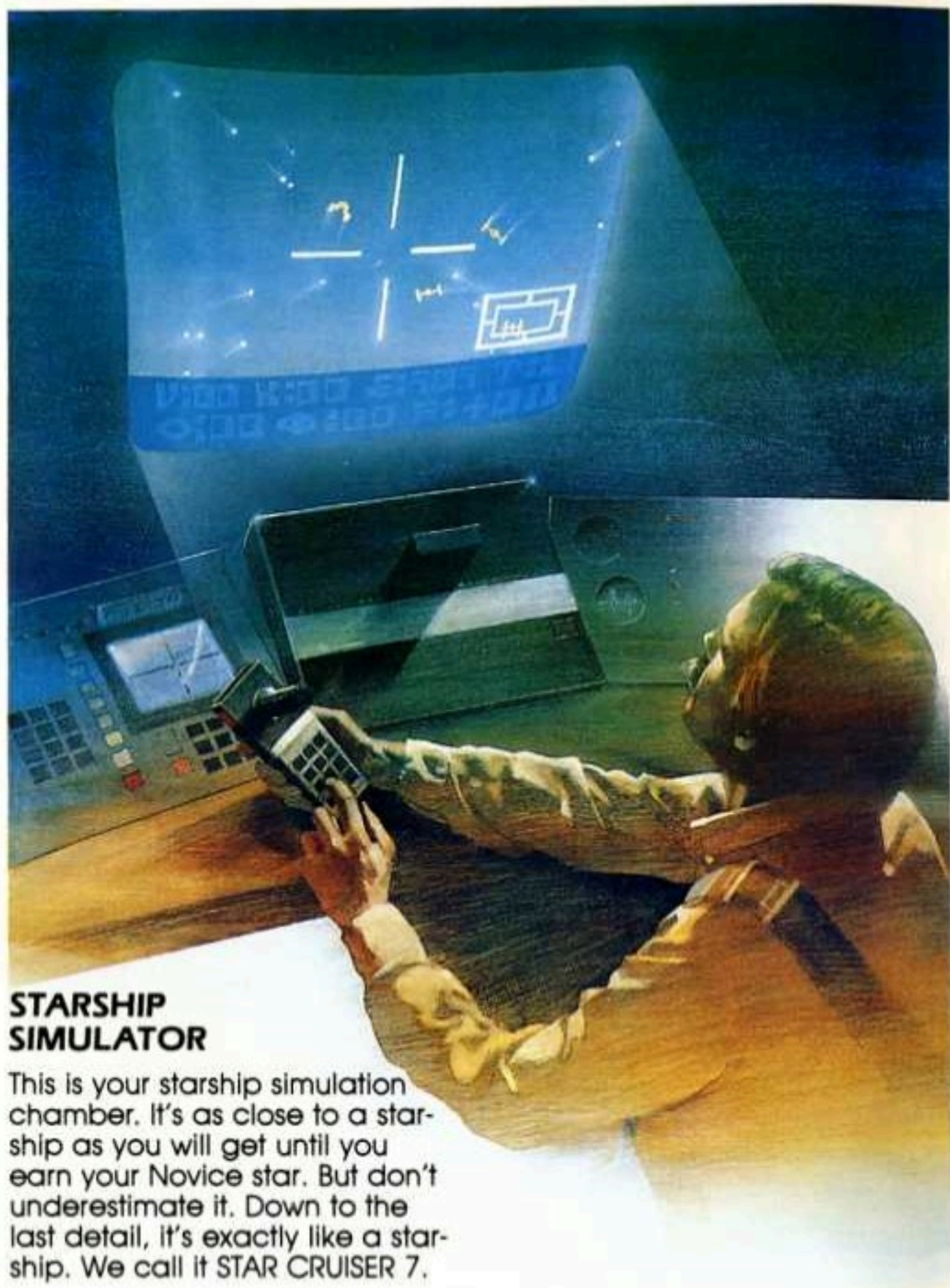

STARSHIP SIMULATOR

This is your starship simulation chamber. It's as close to a starship as you will get until you earn your Novice star. But don't underestimate it. Down to the last detail, it's exactly like a starship. We call it STAR CRUISER 7.

Step inside and climb into the cockpit in front of the ATARI 5200 console. Insert the STAR RAIDERS cartridge, which contains the simulation program, into the console cartridge slot (see *inside front cover for directions*). Now turn on the television, your window into space. Turn up the volume so you can experience the audio as well as visual effects of space flight.

Attach the keypad overlay to the ATARI 5200 controller and plug the controller into Jack 1 on the front of the console. Your 5200 controller is an exact duplicate of a real starship controller. It's an incredible device. With this little controller in hand, you command every function of STAR CRUISER 7, from engines to photon torpedoes.

Get ready for liftoff. Buckle your seat belt and strap yourself into your G-force harness before we power on the simulator. (G-force is the gravitational force to which a body is subjected during acceleration.)

Ready?

Power on by pressing the **POWER** switch on the 5200 console unit. When the ATARI logo appears on your screen, start the count-down: 5, 4, 3, 2, 1, LIFTOFF!

Star Cruiser 7 is launched into space when NOVICE MISSION flashes on the screen (*Figure 1*). Stars and meteors whiz past your starship as you cruise forward at a comfortable speed of 12 metrons per second. (Metrons per second is an Earth Federation unit of space-time for speeds above 186,000 miles per second, the speed of light.)



Figure 1 - Forward (Fore) View of Space



3. USING THE 5200™ CONTROLLER

With the 5200 controller (*Figure 2*) you'll pilot Star Cruiser 7, control both Twin Ion and Hyper-warp engines, call up computer displays, track the enemy, fire your photon missiles, and dock at a starbase. We'll take a look at the control stick (sometimes called a joystick) in a minute. Now let's talk about control keys.

KEYPAD OVERLAYS

For your convenience, two keypad overlays are provided (*Figure 3*). Slip the overlay tabs into the slots above and below the keypad on the controller.

CONTROL KEYS

- **START:** Brings up the Control Panel Display and starts the action (see *Figure 4*). Use **START** to start a new mission at the same skill level.



Figure 4 - START Starts the Action



Figure 2 - Controller

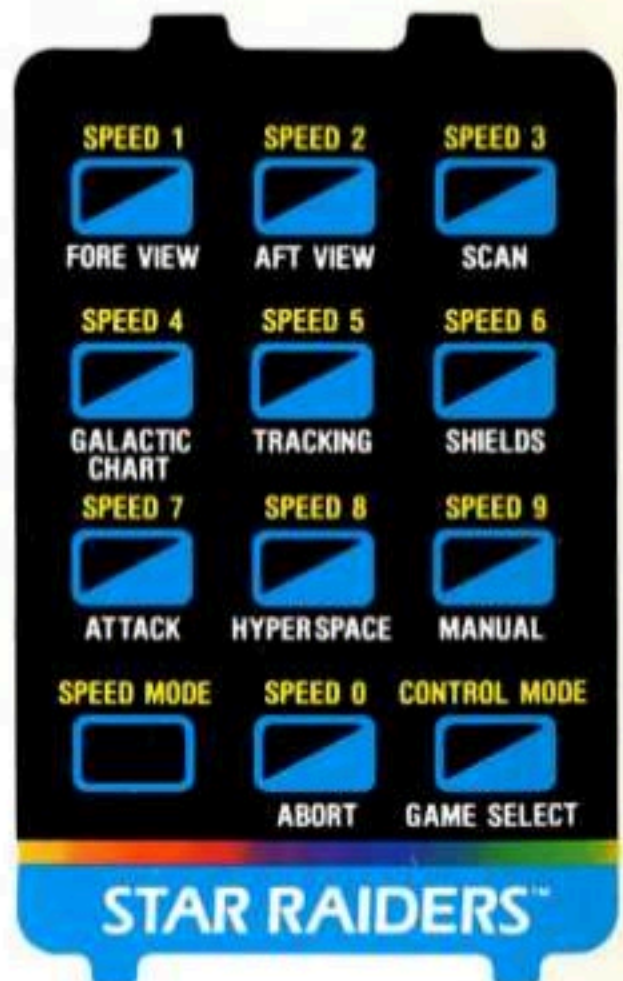

Figure 3 - Overlay

- **PAUSE:** Freezes action temporarily. Press again to continue.

NOTE: If **PAUSE** is on longer than 8 minutes, the computer will cycle colors on the television screen to prevent "burn in" of static images.

- **RESET:** Resets STAR RAIDERS to the beginning at NOVICE MISSION skill level (see *Figure 1*).
- **GAME SELECT (#):** After powering on, press the **GAME SELECT** key (#) to change the mission skill level. Thereafter, press **RESET** once before **GAME SELECT** to change the skill level. Hold in **GAME SELECT** to cycle through the skill levels.

This key functions as the **CONTROL MODE** key after you press **START**. We'll discuss the Control Mode in *Section 5*.

- **SPEED MODE (*):** Once you've pressed **START**, this key puts your starship into Speed Mode, discussed in *Section 4*. This key has no function until you press **START**.

CONTROL STICK OPERATION

The control stick rotates 360 degrees and handles your starship with ease. In the Fore View (forward view of space) the control stick operates as shown

in *Figure 5A*. In the Aft View (back view of space) operation is reversed (*Figure 5B*). You'll learn how to switch from Fore View to Aft View in *Section 5 - CONTROL MODE*.

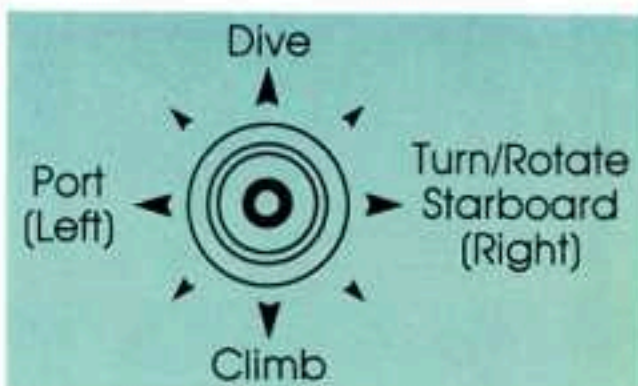

A. Fore View Control

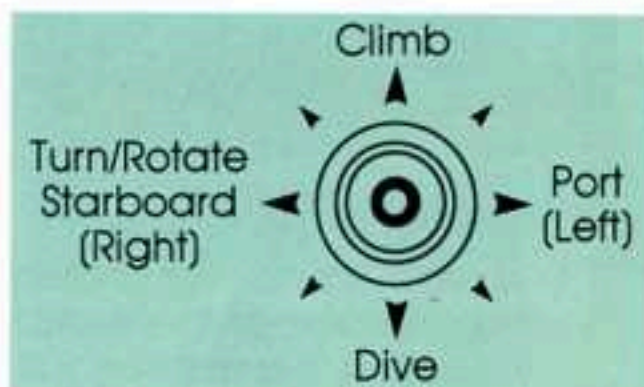

B. Aft View Control

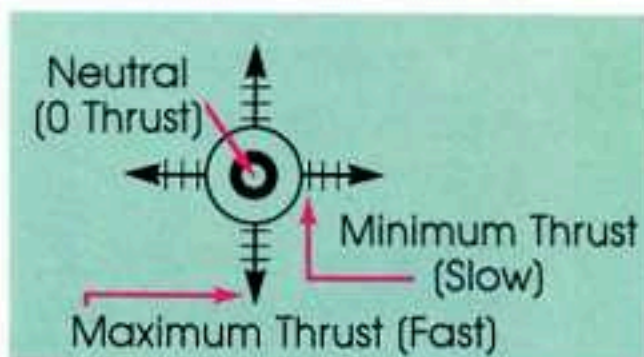

C. Thrust Rates

Figure 5 - Control Stick Operation

5. CONTROL MODE

When your starship is in Control Mode, all the number keys on your keypad operate starship equipment or program modes of operation (*Figure 7*).

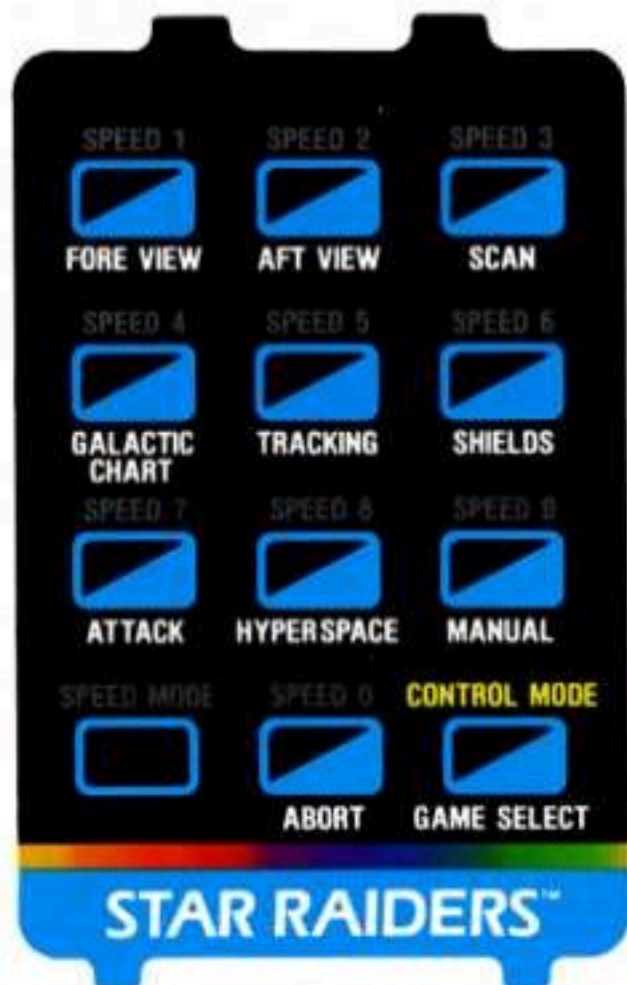

Figure 7 - Control Mode Keys

Try this:

1. After **START**, press the **CONTROL MODE** key (#).
2. Press the **AFT VIEW** key (2): **AFT VIEW** appears at the top of the television screen. The **Aft**

View is the view of space from the aft or back space window. Stars and meteors appear to recede into the distance as your starship moves forward.

3. Press the **FORE VIEW** key (1) to restore the **Fore View** of space (*Figure 1*).

Now let's look at the starship equipment operated in Control Mode.

SHIELDS

Before you set out on a mission, press the **SHIELDS** key (6) and turn on your shields. **SHIELDS ON** appears momentarily at the top of your screen and space looks blue.

With shields on, your starship can never be destroyed by enemy photon torpedoes or meteors ... unless, of course, it hyperwarps into a meteor. Without shields, it hasn't a snowball's chance. At **NOVICE** skill level, shields prevent your starship from being damaged. At all other skill levels, shields give protection but do not prevent damage. (See *Section 7 - STARSHIP DAMAGE* for more information.)

To turn off the shields, press **SHIELDS** (6) again. **SHIELDS OFF**

appears at the top of the screen and space looks black.

ATTACK COMPUTER

Your next move is to turn on your Attack Computer. Press the **ATTACK** key (7). **ATTACK COMPUTER ON** appears momentarily at the top of the screen, along with the target crosshairs and the Attack Computer Display (*Figure 8*). In the Aff View, only the target crosshairs appear; there is no Attack Computer Display.



Use the Attack Computer Display to track enemy targets (see *PHOTON TORPEDOES*), starbases (Section 8 - *STARBASE DOCKING*), and meteors (Section 12 - *SURVIVAL TACTICS*).

To turn off the Attack Computer Display, press the **ATTACK** key (7) again. **ATTACK COMPUTER OFF** appears at the top of the screen.

GALACTIC CHART

After turning on your shields and the Attack Computer, press the **GALACTIC CHART** key (4) to display the Galactic Chart and target data (*Figure 9A*). The chart shows you the whole galaxy, divided into sectors. Some sectors contain enemy spacecraft and friendly starbases; others are uninhabited. Starbases are indicated by ☼;

Zylon spaceships are identified as follows:

-  = patrol consisting of two enemy ships
-  = task force of three enemy ships
-  = fleet of four enemy ships.



Target Crosshairs Attack Computer Display

Figure 8 - Attack Computer On



Figure 9A - Galactic Chart

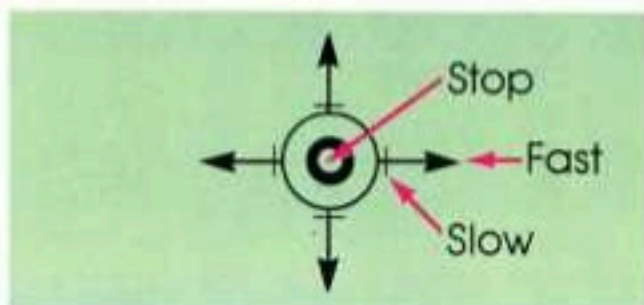

Figure 9B - Cursor Control Speeds

MARKING THE TARGET

Choose an enemy target sector. With the control stick, move the cursor (+) from its position in the center of the chart to the target sector. Note that a blinking ring (⊕) remains in the center. The ring marks the sector you move from; the cursor marks the sector you move to.

You can move the cursor from sector to sector at fast or slow speed, as shown in **Figure 9B**:

- Slow: Keep the control stick close to center.
- Fast: Push the stick as far as possible in the direction you want the cursor to move.
- Stop: Center the control stick.

NOTE: The cursor can “wrap” around the Galactic Chart vertically and horizontally. For example, it can leave the Galactic Chart at the bottom and reappear at the top, or leave the chart at the right side and reappear at the left side.

Which sector should you choose?

A two-ship patrol is the easiest target to begin with, but there are other considerations:

Warp Energy: You must hyper-warp from sector to sector, and that uses up a lot of energy. The further the target, the more energy you use. In general, it is more economical to cover the Galactic Chart in short jumps. We’ll go into energy drain more thoroughly in *Section 6*.

Enemy Position: Zylon ships constantly shift sectors in an effort to surround and destroy starbases. You will save yourself a lot of grief if you go after targets that are in dangerous positions, such as next to a starbase.

STARBASE SURROUNDED

Your subspace radio will flash STARBASE SURROUNDED on your screen when Zylon combat ships surround a starbase. After the warning, you have 1 minute to clear enemy ships from a sector next to the starbase and save the base. If Zylon succeeds in destroying the starbase, you will lose a vital energy and repair port, and Zylon will build two new combat ships out of the starbase debris.

Figure 10 shows the enemy positions required for a starbase to be surrounded.

NOTE: THE ZYLON FLEET WILL ATTEMPT TO SURROUND AND DESTROY ONLY ONE STARBASE AT A TIME.

The Zylons will shift sectors at different rates, depending on their size. A patrol will move the fastest, a task force at half the speed of a patrol, and a fleet at approximately 1/8 the speed of a patrol.

TARGET DATA

When you have selected your target, read the target data under the Galactic Chart (**Figure 11**):

WARP ENERGY: Number of energy units required to hyper-warp to the sector selected.

TARGETS: Number of enemy targets in the sector selected.

STAR DATE: Elapsed time during a mission, measured in *centons*; 100 centons = 1 minute. The enemy may jump from one sector to another when the STAR DATE counter crosses .00 or .50.

DC:PESCLR: DC = Damage Control, P = Photon Torpedoes, E = Engines, S = Shields, C = Com-

puter, L = Long-Range Scan, R = Subspace Radio. Status of the equipment is shown by the color of the letter:



We will discuss starship damage in more detail *in Section 7*.

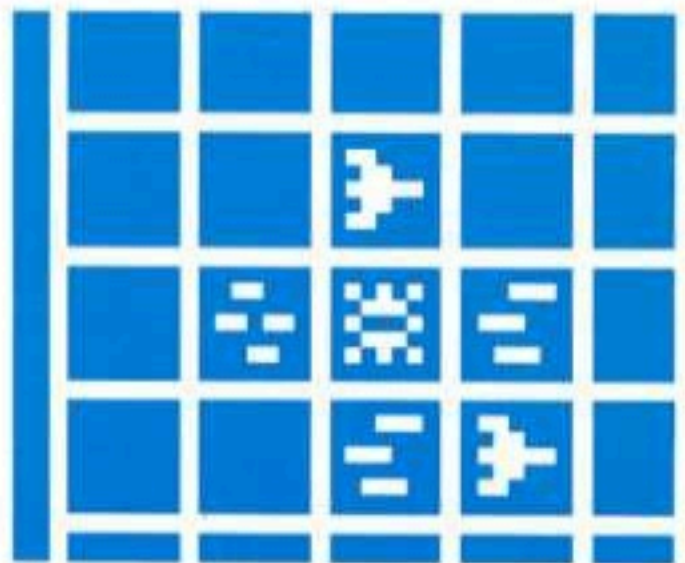

Figure 10 - Starbase Surrounded



Figure 11 - Target Data

HYPERWARP

The **HYPERSPACE** key (8) turns on your Hyperwarp Engines, and **HYPERSPACE ENGAGED** appears momentarily at the top of the screen. Before you activate your Hyperwarp Engines, however, be sure the Attack Computer is on. You need the crosshairs for navigating in hyperspace and the Attack Computer Display for tracking targets.

NAVIGATING IN HYPERSPACE

At **NOVICE** skill level, you do not need to steer your starship. The computer centers the Hyperwarp Target Marker in the crosshairs and keeps the starship on course (see *Figure 12*).

At **PILOT**, **WARRIOR**, and **COMMANDER** skill levels, you must steer in hyperspace. Using the control stick, keep the Hyperwarp Target Marker centered in the crosshairs. A light touch on the control stick is recommended for steering.

You must get the target marker centered in the crosshairs by the time **HYPERSPACE** or **HYPERSPACE COMPLETE** flashes on the screen; otherwise you will be off course and out of your target sector. Just before hyperwarp is completed, the engines reach

peak velocity and volume. Press the **HYPERSPACE** key (8) now and listen to the engines so you will recognize peak level when you're in hyperspace.

NOTE: The further the distance between sectors, the harder it is to stay on course in hyperspace.

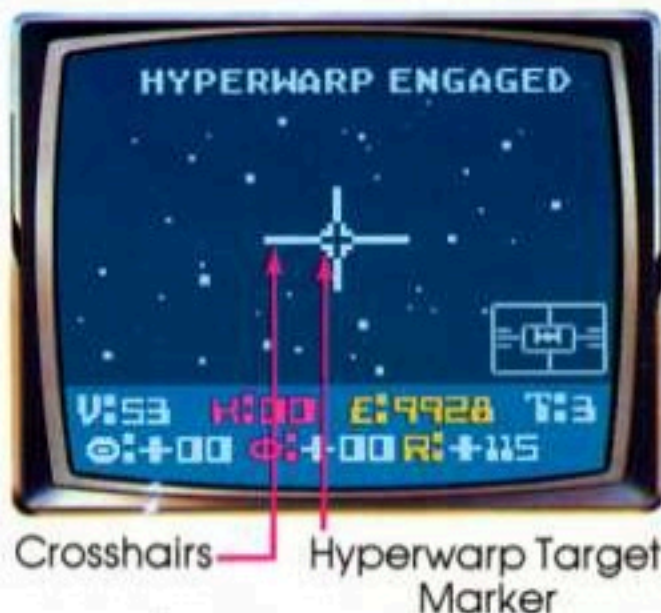

Figure 12 - Hyperwarp Engaged



ENTERING A SECTOR

When you enter a sector occupied by Zylon combat ships, the computer flashes **HYPERSPACE** and sounds the **RED ALERT**. Note that a **target marker**, showing the position of the target relative to your starship, appears in the Attack Computer Display (*Figure 13A*).

When you enter a sector with a starbase in it, **HYPERWARP COMPLETE** flashes at the top of your screen and a target marker, showing the position of the starbase, appears in the Attack Computer Display (*Figure 13B*).

When you enter an empty target sector, **HYPERWARP COMPLETE** flashes on the screen but there is no target marker in the Attack Computer Display (*Figure 13C*). Return to the Galactic Chart and correct your position.

HYPERWARP ABORT

If you're in hyperwarp when you get a **STARBASE SURROUNDED** message, abort hyperwarp and return to the Galactic Chart to see which starbase is in trouble. To abort hyperwarp, press the **ABORT (O)** key. When **HYPERWARP ABORTED** appears on your screen, press the **GALACTIC CHART** key (4).



Target Marker

Figure 13A - RED ALERT



Figure 13B - Starbase Sector



Figure 13C - Empty Sector

PHOTON TORPEDOES

A photon torpedo is a burst of concentrated energy that can completely destroy an enemy spaceship, meteor, or another photon torpedo. As long as you have energy, you never run out of torpedoes, but each time you fire, 10 units of energy are used up. If you hit another photon torpedo head on, 100 units of energy are used up (see Section 6 - **ENERGY DRAIN**). Obviously, then, you should make each photon torpedo count and not fire randomly.

Your starship is equipped with two torpedo launchers, on the port and starboard sides. You can only fire one torpedo at a time, except when the Attack Computer locks your torpedoes onto the target; then the fire button launches both photon torpedoes simultaneously.

Lock-on occurs when the target marker is centered in the Attack Computer Display and the horizontal (⊖) and vertical (⊕) coordinates in the Control Panel Display read +00. In **Figure 14**, the lines labeled "A" show that the computer is locked on in the horizontal coordinate; those labeled "B" show that the computer is locked on in the vertical coordinate. When the marks designated "C" appear, the computer is locked on in both coordinates and the target is

within range. This is the best time to fire; you have a 90% kill probability at this time.

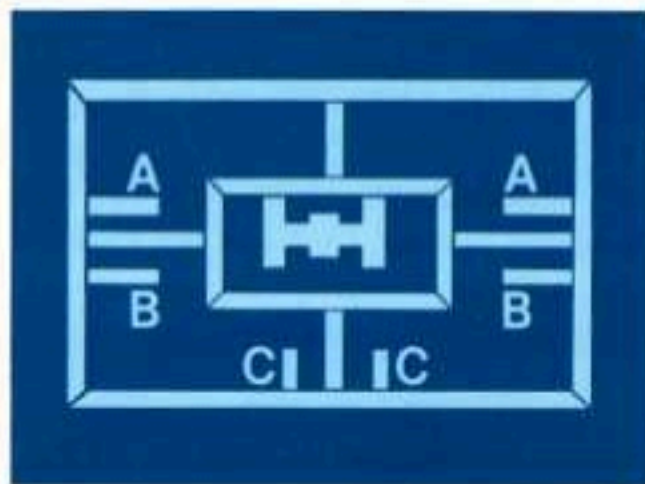

Figure 14 - Target Locked On and Within Range

NOTE: Of course you can hit the enemy without locking on your torpedoes, but you use up more energy.

When you hit a target (enemy ship, space object, or photon torpedo) it explodes into silver particles (**Figure 15**). If your target is a Zylon fighter or cruiser, your hit destroys it and the computer credits you with a kill (see **CONTROL PANEL DISPLAY**). If it's a Zylon basestar, a hit does not always destroy it. Basestars are protected by shields and can only be destroyed by a direct hit.

When an enemy ship hits your starship (with shields on), the screen flashes red and blue. (Colors may vary with the set-

tings of your television set.) If your ship is damaged, DAMAGE CONTROL sounds a warning and flashes a message on your screen telling you what equipment has been damaged or destroyed (see Section 7 - **STARSHIP DAMAGE**).

After you have wiped out all Zylon spacecraft in a sector, the target marker in the Attack Computer Display disappears. Return to the Galactic Chart and select another sector.

CONTROL PANEL DISPLAY

The Control Panel Display appears at the bottom of the screen in the Fore, Aft, and Long-Range Views. The display shown in *Figure 16* is interpreted as follows:

- V:12 - Velocity is 12 metrons per second.
- K:18 - So far you have 18 kills to your credit.
- E:8260 - You have 8260 energy units left (out of 9999 units at mission start).
- T:2 - The Attack Computer is currently tracking Target 2, which is a starbase; T:0 or T:1 would be an enemy target, and T:3 would be hyper-space. When the Track-



Figure 15 - Zylon Ship Hit



Figure 16 - Control Panel Display

ing Computer is on, T changes to C.

- ⊖ :+12 - In the horizontal coordinate, your starship is off target by +12 gradons (see Note).
- Φ :+10 - In the vertical coordinate, your starship is off target by +10 gradons.

R:+236- The target is 236 centrons in front of your starship (see Note). If R were -236, the target would be 236 centrons behind your starship.

NOTE: Angles are measured in gradons (0 - 99 gradons). Distance is measured in metrons; 100 metrons = 1 centron.

LONG-RANGE SECTOR SCAN

When there's a target marker in the Attack Computer Display but you can't seem to find the target, use the Long-Range Sector Scan (*Figure 17*). Press the **SCAN** key (3).



Target Destination Starship Target

Figure 17 - Long-Range Sector Scan

The Long-Range Sector Scan shows you a top view of the sector your starship is in. In *Figure 17*, your ship is in the center and all objects in the sector rotate around it. To use the sector scan:

1. Select a target.
2. Move the control stick to the left until the target is directly in front of you.
3. Move the control stick forward or back, depending on the position of the target, until the target is as far above your starship as possible.
4. Enter Speed Mode (#) and use your engines to approach the target. Select a moderate **SPEED** key (3, 4, or 5).
5. Minor course corrections may be needed as you approach the target. Repeat steps 2 and 3 if required.
6. When the target is very close to your starship, press the **O** key to stop the engines.
7. The target should now be visible in the Fore View. Press the **CONTROL MODE** key (#), then the **FORE VIEW** key (1).

MANUAL TARGET SELECTOR

When more than one Zylon ship is attacking, the Attack Computer decides which target to track and display. The computer selects a target at random unless you are in a space duel, in which case it selects the target that is shooting at you.

If you wish to select a different target, press the **MANUAL** key (9) to override the computer and call up the Manual Target Selector. Normally only two Zylons attack at the same time. The Control Panel shows them as T:0 and T:1, target 0 and target 1. If T:0 is displayed, pressing the **MANUAL** key automatically selects T:1 and vice versa.

To return to automatic target selection, press the **MANUAL** key (9) again.

TRACKING COMPUTER

The Tracking Computer automatically tracks the selected target as it moves from fore to aft of your starship. The television screen switches between Fore and Aft views as the Tracking Computer tracks the target. Press the **TRACKING** key (5) to turn on the Tracking Computer. **COMPUTER TRACKING ON**

appears momentarily at the top of the screen and the Aft View is displayed. To turn off the Tracking Computer, press the **TRACKING** key (5) again. **TRACKING OFF** will be displayed at the top of the screen. Note that if you switch off the Tracking Computer in the Aft View, you must press the **FORE VIEW** key (1) to restore the forward view of space.

WARNING! This mode should be used by experienced space pilots only. It is possible to get caught in the cross-fire of two enemy ships, one in front and the other behind your starship. As they alternately fire at you, the computer will constantly switch between Fore and Aft views, so fast that only experienced Star Raiders are able to survive.

SUBSPACE RADIO

The Subspace Radio is used to update the Galactic Chart and relay the messages **STARBASE SURROUNDED** and **STARBASE DESTROYED**. It also generates the **TARGETS** display below the Galactic Chart.



6. ENERGY DRAIN

Your starship has 9999 units of energy at the start of each mission. Each operation drains some of this energy. Note that the faster your starship travels, the more energy you use. In

terms of the tradeoff between energy drain and distance covered, speed 6 (velocity = 12 metrons per second) is the most efficient speed.

Operation	Energy Drain (units)
Abort Hyperwarp	100
Each enemy photon hit	100
Each photon torpedo fired	10
Shields up	2 units per second
Attack Computer on	½ unit per second
Life Support System (always on)	¼ unit per second

Twin Ion Engines (Speed)	0	1	2	3	4
Energy Drain / Second (units).	0	1	1.5	2	2.5
Twin Ion Engines (Speed)	5	6	7	8	9
Energy Drain / Second (units).	3	3.5	7.5	11.25	15

The longer the hyperwarp jump, the greater the energy drain. Jumps of five sectors or more are very costly. If you must go a long distance, try to do it in several small jumps instead of one long jump.

When energy falls below 1000 units, the Control Panel Display flashes a red warning. You can refuel at any starbase provided your starship has the energy to get there. See Section 8 - STAR-

BASE DOCKING for refueling instructions. If you run out of energy, Mission Control will abort your mission and recall you to base.

RETURN TO BASE

Hyperwarp Distance (Sectors)	1	2	3	4	5	6	7	8
Energy Drain Per Jump (Units)	130	160	200	230	500	700	800	900
Hyperwarp Distance (Sectors)	9	10	11	12	13	14	15	16
Energy Drain Per Jump (Units)	1200	1250	1300	1350	1400	1550	1700	1840
Hyperwarp Distance (Sectors)	17	18	19	20	21	22	23	
Energy Drain Per Jump (Units)	2000	2080	2160	2230	2320	2410	2500	

7. STARSHIP DAMAGE

DAMAGE CONTROL flashes a message on your screen when any of these units is damaged or destroyed:

- Photon Torpedoes
- Twin Ion Engines
- Shields
- Attack Computer
- Long-Range Scan
- Subspace Radio.

In addition, the Damage Control Indicator below the Galactic Chart (*Figure 18*) keeps track of equipment that is damaged or destroyed:

DC = Damage Control, P = photon torpedoes, E = engines, S = shields, C = attack computer, L = long-range scan, and R = subspace radio. A yellow letter means equipment damaged; a red letter means equipment destroyed.

PHOTON TORPEDOES

When your photon torpedoes are damaged, only one operates, but you can continue your mission. When they are destroyed, your position is suicidal. Get out of the target sector fast, find a starbase on the Galactic Chart, and hyperwarp to it for repairs. (See Section 8 - **STARBASE DOCKING**.)



Figure 18 - Damage Control Indicator

TWIN ION ENGINES

Your engines will work when damaged, thanks to a backup impulse system; however, progress will be slow. If your engines are destroyed, your speed will be very slow and your starship will be extremely vulnerable. You can, however, use the hyperwarp engines to move within a sector. Press the O key and abort hyperwarp when you are close to the target (see *Hyperwarp Abort* in Section 5). Better yet, dock at a starbase for repairs.



SHIELDS

Shields will flicker when damaged, and the Control Panel Display and Galactic Chart will turn yellow. If you take a hit when your shields have flickered off, you will be destroyed in a blinding flash. Don't take chances. When your shields are damaged, get out of the target sector fast and hyperwarp to the closest starbase. (See Section 12 - **SURVIVAL TACTICS** for some tips.)

ATTACK COMPUTER

When the computer is damaged, **⊖**, **⊕** and **R** in the Control Panel Display are lost. When your computer is destroyed, all computer functions cease: the Manual Target Selector and Tracking Computer do not function, and the target crosshairs and Attack Computer Display disappear. It will be extremely difficult to steer in hyperspace and dock at a starbase without the crosshairs and Attack Computer Display, but you can do it. See Section 12 - **SURVIVAL TACTICS** for help.

LONG-RANGE SCAN

Damage to the Long-Range Scan causes a mirror image of every object being scanned, and you will have to distinguish between the real object and its reflection. Select a target and follow steps 2, 3, and 4 in the Long-Range Scan instructions (Section 5). If the target moves away from you instead of toward you, it's the reflection.

SUBSPACE RADIO

If the Subspace Radio is damaged, the Galactic Chart will not be updated. However, moving the cursor around the Galactic Chart will update the TARGETS indicator below the Galactic Chart and show you the number of enemy targets in each sector.

If the radio is destroyed, you're in big trouble. No starbase messages will be relayed, so you will not know when a starbase is surrounded. Hyperwarp to a starbase and repair your radio at once.

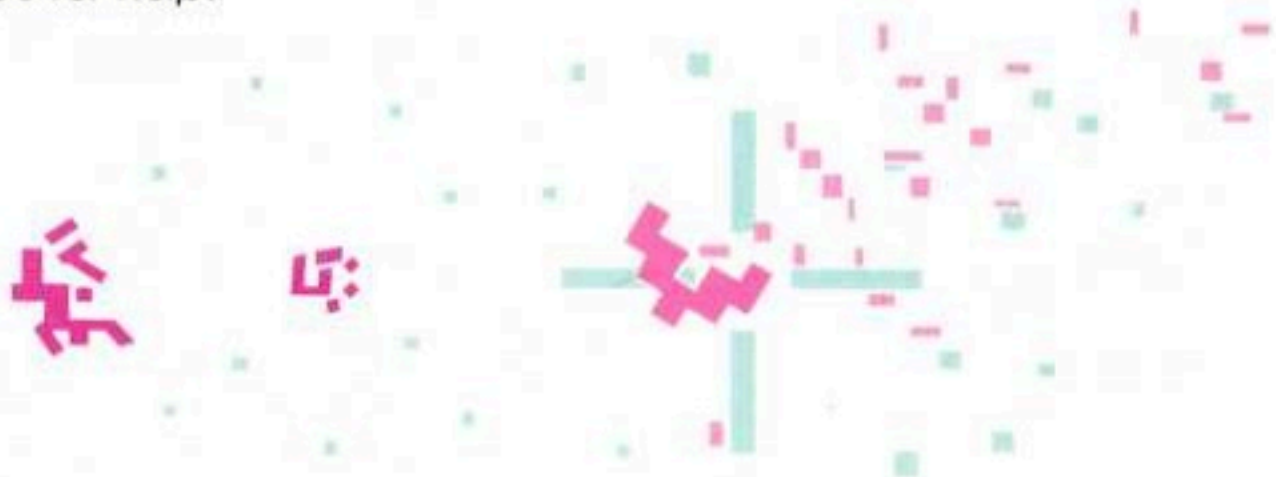

8. STARBASE DOCKING

When your energy supply falls below 1000 units or your starship needs repairs, return to the Galactic Chart and find a starbase. Position the cursor in the center of the starbase sector (☄). The closer the cursor is to the center, the closer your starship will be to the starbase. Engage hyperwarp by pressing the **HYPERSPACE** key (8). If you are on course when **HYPERSPACE COMPLETE** flashes on your screen, a target marker should appear in the Attack Computer Display. Proceed as follows:

1. Center the target marker in the Attack Computer Display.
2. Check the range (R) of the starbase on the Control Panel Display. You want the starbase in front of you, not behind you, so the range indicator should read +. If it reads -, move the control stick toward you or away from you, as required, to change the range reading to a + value.
3. Adjust your position horizontally. Move the control stick right or left, as required, until the Φ coordinate in the Control Panel Display reads + or -3.
4. Adjust your position vertically. Move the control stick forward or back, as required, until the Φ coordinate reads + or -3.
5. Bring the starbase within range: Press the **SPEED MODE** key (★) and select an appropriate **SPEED** key, depending upon how far away you are. Decrease your speed as you approach the starbase. When R is +000, press **SPEED** key O to stop your engines.
6. When you have the starbase locked on, **ORBIT ESTABLISHED** should appear momentarily on your screen (*Figure 19A*). If it does not appear, adjust your position and range slightly.
7. When orbit is established, you will receive a message to **STANDBY** while the Transfer Vessel leaves the starbase and services your starship (*Figure 19B*). When **TRANSFER COMPLETE** appears, your starship is ready to hyperwarp to another sector. Re-enter Control Mode (♯) and return to the Galactic Chart.

NOTE: If you hit a key or move the control stick before docking is completed, DOCKING ABORTED will appear on the screen. Adjust your position and range, as required, to bring back ORBIT ESTABLISHED.

TRANSFER COMPLETE



Starbase Locked On

Figure 19A - Starbase Docking



Transfer Vessel

Figure 19B - Energy Transfer

STARBASE DESTROYED

If Zylon destroys your starbase while you are attempting a docking, you will find yourself in enemy-occupied territory and under attack by two new enemy ships created from the starbase debris. If your starship is in shape to fight, you can engage and destroy the enemy before you leave the sector. The

target marker remains in the Attack Computer Display after the starbase is destroyed so you can track the enemy. If you're not in a position to fight your way out of the sector, re-enter Control Mode and return to the Galactic Chart to find another starbase.



9. RATING

A mission ends when ...

- You destroy all enemy targets and complete your mission.
- You run out of energy and your mission is aborted.
- Your starship is destroyed.

No matter how your mission ends, you will receive a rating on your performance ... a post-humous rating if your starship is destroyed.

Mission Control bases each rating on the following factors:

- Mission skill level
- Number of enemy combat ships destroyed
- Amount of energy used
- Length of time taken to complete mission
- Number of starbases destroyed.

Here's the formula:

$$\begin{aligned} & M + 6 (\text{No. of enemy destroyed}) - \text{energy used}/100 \\ & - \text{Length of time taken}/100 - 18 (\text{No. starbases Zylon destroyed}) \\ & - 3 (\text{No. of starbases you destroyed}), \end{aligned}$$

where M is a mission factor determined as follows:

Mission Level	Bonus for Completing Mission	Mission Aborted	Penalty for Destruction of Starship
NOVICE	M = 80	M = 60	M = 40
PILOT	M = 76	M = 60	M = 50
WARRIOR	M = 60	M = 50	M = 40
COMMANDER	M = 111	M = 100	M = 90

Note that the formula penalizes you more for allowing Zylon to destroy a starbase than for destroying one yourself. I'll have more to say about that when we study survival tactics in Section 12.

Your NEW RANK is displayed at the top of the television screen by rank and class. There are five classes per rank, Class 1 being the highest and Class 5 the lowest.

If you do not score at least 48 points on a mission, your new rank will be GALACTIC COOK or GARBAGE SCOW CAPTAIN. If you can't do better than that, your

Rank	Mission Score
ROOKIE	48 - 79
NOVICE	80 - 111
ENSIGN	112 - 143
PILOT	144 - 175
ACE	176 - 191
LIEUTENANT	192 - 207
WARRIOR	208 - 223
CAPTAIN	224 - 239
COMMANDER	240 - 271
STAR COMMANDER	272 - 303

mission skill level is too advanced for you. Switch to a lower skill level and work your way back up.

10. MISSION SKILL LEVELS

Any time your rating puts you on a different skill level ... NOVICE, PILOT, WARRIOR, or COMMANDER ... press **RESET**, then **GAME SELECT (#)** and change the skill level at the top of your screen.

NOVICE LEVEL

- 3 starbases
- 9 enemy sectors with total of 27 enemy combat ships
- With shields on, starship cannot be damaged.
- Computer steers during hyperwarp.

PILOT LEVEL

- 4 starbases
- 12 enemy sectors with total of 36 enemy ships
- Starship can be damaged with shields on
- Must steer during hyperwarp.

WARRIOR LEVEL

- 5 starbases
- 15 enemy sectors with total of 45 enemy ships
- Starship can be damaged with shields on.

- Steering required during hyperwarp
- Enemy attacks are faster and more devastating.

COMMANDER LEVEL

- 6 starbases
- 18 enemy sectors with 54 enemy ships

- Starship can be damaged with shields on
- Steering required during hyperwarp
- Constant attacks under very hazardous conditions.

COMMANDER missions are only recommended for the most experienced Star Raiders.

11. TRAINING MISSION



This is It! Time to solo. Complete this training mission with a rank higher than ROOKIE to win your NOVICE star and full commission in the Star Raiders. Here we go.

1. If required, press **RESET** and use the **GAME SELECT** key (#) to select NOVICE MISSION.
2. Press **START**. Note that the Control Panel Display appears.
3. Press the **CONTROL MODE** key (#).
4. Press the **SHIELDS** key (6) to turn on your shields.
5. Press the **ATTACK** key (7) to turn on the Attack Computer Display.
6. Press the **GALACTIC CHART** key (4) to display the Galactic Chart.
7. Move the cursor to an enemy target sector. A two-ship patrol is the easiest target to start with, but your first choice should be a target that is threatening a starbase.
8. Read the target data under the Galactic Chart.
9. Press the **FORE VIEW** key (1) to bring up the Attack Computer Display.
10. Press the **HYPERSPACE** key (8) to engage your hyperwarp engines.
11. When **RED ALERT** flashes on your screen, you've arrived in the target sector.

12. Center the target marker in the Attack Computer Display. Remember that the best time to fire is when your photon torpedoes are locked onto the target.
13. Destroy all enemy targets in the sector. When there's no longer a target marker in the Attack Computer Display, you've completed your task in the sector.
14. Return to the Galactic Chart, select another sector, and repeat Steps 8 through 14 until you've destroyed all the Zylon ships.

REMINDER! You have just 1 minute to rescue a starbase after your subspace radio flashes **STARBASE SURROUNDED**. If you are in hyperspace at the time, abort (press **ABORT** or **O**) and return to the Galactic Chart. Select an enemy sector next to the besieged starbase and repeat steps 8 through 14.

STARBASE DOCKING

When the energy gauge in the Control Panel Display drops below 1000 and the Control Panel flashes the red low-energy warning, hyperwarp to a starbase and energize your starship:

1. If you're in hyperspace, press the **ABORT** key (**O**), then select the Galactic Chart.
2. Move the cursor to the center of a starbase sector.
3. Put your starship into the Fore View, then engage your hyperwarp engines.
4. When **HYPERWARP COMPLETE** flashes on your screen and the target marker appears in the Attack Computer Display, you've arrived.
5. Using your control stick, get the starbase in front of you (**R** = a + value) and correct your position until both **☉** and **☽** coordinates = + or -3.
6. Press the **SPEED MODE** key (*****). Select the appropriate **SPEED** key and bring the starbase into range. When **R** = +000, press the **O** key to stop your engines.
7. After establishing orbit, wait for **TRANSFER COMPLETE**. Then re-enter Control Mode and return to the Galactic Chart to select an enemy target.

RATING

When your mission is ended, you'll receive your rating.

Good news?
Congratulations! Prepare your dress uniform for graduation and receive your Novice star. You are now a full-fledged member of the Star Raiders!

Bad news?
Don't be discouraged. Some of the most famous Star Raiders didn't win their stars the first time. Try again. You'll do it next time.



12. SURVIVAL TACTICS

Here are some survival tactics that experienced Star Raiders use to help them complete their missions and earn a promotion. If you have a few tips of your own, tell your fellow Star Raiders.

HOW TO MAKE A FAST RETREAT

When your shields are destroyed, the next enemy hit will destroy your starship. To get out of the sector fast, press the **HYPERSPACE** key (8) and hyperwarp out of the sector without consulting the Galactic Chart. When you're safe in an empty sector, return to the Galactic Chart and locate a starbase.

HOW TO REACH A STARBASE FASTER

If you know there's a starbase next to the enemy sector you're in, you can hyperwarp directly to the starbase sector without using the Galactic Chart. In hyperspace, move the Hyperspace Target Marker to the edge of the crosshair that points in the direction of the starbase.

HOW TO FIND A STARBASE WITHOUT THE COMPUTER

How can you find a starbase when your Attack Computer Display doesn't work? Here's some help:

Locate a starbase on the Galactic Chart and engage your hyperwarp engines. As you enter hyperspace, note the position of the Hyperspace Target Marker and try not to stray from that position.

When hyperwarp is completed, press the **SCAN** key (3). If you're in the starbase sector, the starbase should be visible on the Long-Range Sector Scan. If it is not, return to the Galactic Chart, correct your position, and try again.

When you get the starbase on the Long-Range Scan, center it as instructed in Section 5, **LONG-RANGE SECTOR SCAN**. Then press the **FORE VIEW** key (1). The target should now be visible on the screen.

LOW ON ENERGY?

If your energy supply threatens to run out while you are trying to dock at a starbase, turn off your shields temporarily. This will save 2 units of energy per second and may buy you enough time to establish orbit and energize your starship. Don't forget to turn your shields back on before you hyperwarp into an enemy sector.

WHEN TO SACRIFICE A STARBASE

When you cannot save a starbase, it is better to destroy it yourself than let Zylon destroy it. Mission Control doesn't penalize you as much when you destroy a starbase, because Zylon cannot use the starbase debris to build two new combat ships.

NEED A LITTLE TARGET PRACTICE?

After you destroy a starbase, the Attack Computer tracks meteors in the starbase sector, since there are no enemy targets to track. This gives you a perfect opportunity to practice homing in on the target and locking on the photon torpedo (see **PHOTON TORPEDOES** in Section 5). Meteors make good tracking targets because they never alter course. Sorry, you do not get kill credits for zapping meteors.



ATARI® STAR RAIDERS



 A Warner Communications Company

ATARI, INC., Consumer Division
P.O. Box 427, Sunnyvale, CA 94086