



# WORLD RALLY™



*Universal conversion kit for  
one-player upright games*



## Universal Kit Installation Instructions



## **For technical assistance:**

If reading through this manual does not lead to solving your game maintenance or repair problem, call TELE-HELP® at one of these Atari Games Customer Service offices:

### **UNITED STATES**

Atari Games Corporation  
California Customer Service Office  
737 Sycamore Drive  
Milpitas, CA 95035

**Fax (408) 434-3945**  
**Telex 5101007850**

☎ **(408) 434-3950**

(Monday-Friday, 7:30 a.m.-4:00 p.m. Pacific time)

### **EUROPE**

Atari Games Ireland Limited  
European Customer Service Office  
Tipperary Town, Ireland

**Fax 062-51702**  
**Telex 70665**

☎ **062-52155**

(Monday-Friday, 9:00 a.m.-5:30 p.m. GMT)



# WORLD RALLY™

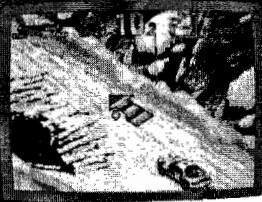
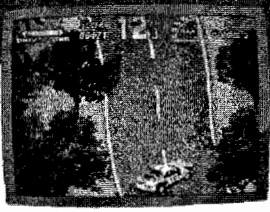

## ***Kit Installation Instructions***

*Universal conversion kit for two-player upright games*

TM & © 1993 Gaelco. All rights reserved. Licensed to Atari Games Corporation.

**Copyright © 1993 by Atari Games Corporation. All rights reserved.**

No part of this publication may be reproduced by any mechanical, photographic or electronic process, or in the form of a phonographic recording, nor may it be stored in a retrieval system, transmitted, or otherwise copied for public or private use, without permission from the publisher.

The game play, all graphic designs, this technical manual, its accompanying schematic diagrams, and the display manual are protected by the U.S. Copyright Act of 1976.

This Act provides for substantial penalties for violating federal copyright laws. Courts can impose infringing articles while legal action is

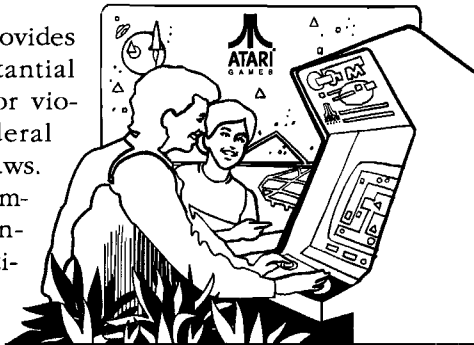

pending. If infringers are convicted, courts can order destruction of the infringing articles.

In addition, the Act provides for payment of statutory damages of up to \$50,000 per infringing transaction in certain cases. Infringers may also have to pay costs and attorneys' fees and face an imprisonment of up to five years as well as fines of up to \$250,000 in the case of individuals and up to \$500,000 in the case of corporations.

Atari Games Corporation will aggressively enforce its copyrights against infringers. We will use all legal means to immediately halt any manufacture, distribution, or operation of a copy of video games made by us. Anyone who purchases such copies risks forfeiting such a game.

Published by:  
Atari Games Corporation  
675 Sycamore Drive  
Milpitas, California 95035

Printed in the U.S.A.     **11/93**

Produced by the Atari Games Technical Publications Department.

Writing and Design: Andrea Dencker

**NOTICE RE.  
NON-ATARI  
PARTS**

**WARNING**

*Use of non-Atari parts or modifications of any Atari game circuitry may adversely affect the safety of your game, and may cause injury to you and your players.*

You may void the game warranty (printed on the inside back cover of this manual) if you do any of the following:

- Substitute non-Atari parts, including cabinetry, in the game.
- Modify or alter any circuits in the game by using kits or parts *not* supplied by Atari Games Corporation.

**NOTE**

This equipment generates, uses, and can radiate radio frequency energy, and if not installed and used in accordance with the instruction manual, may cause interference to radio communications. It has been tested and found to comply with the limits for a Class A computing device pursuant to Subpart J of Part 15 of Federal Communications Commission (FCC) Rules, which are designed to provide reasonable protection against such interference when operated in a commercial environment. Operation of this equipment in a residential area or modification to this equipment is likely to cause interference, in which case the user, at his own expense, will be required to take whatever measures may be required to correct the interference. If you suspect interference from an Atari game at your location, check the following:

- All ground wires in the game are properly connected as shown in the game wiring diagram.
- The power cord is properly plugged into a grounded three-wire outlet.
- On games provided with an Electromagnetic Interference (EMI) ground plane, be sure that the game printed-circuit boards (PCBs) are properly installed on the EMI ground plane and that the end board is securely installed with **all** screws in place and tightened.

If you are still unable to solve the interference problem, please contact Customer Service at Atari Games Corporation. See the inside front cover of this manual for service in your area.



## S A F E T Y S U M M A R Y

The following safety precautions apply to all game operators and service personnel. Specific warnings and cautions will be found in this manual whenever they apply.

### WARNING

**Properly Ground the Game.** Players may receive an electrical shock if this game is not properly grounded! To avoid electrical shock, do not plug in the game until it has been inspected and properly grounded. This game should only be plugged into a grounded three-wire outlet. If you have only a two-wire outlet, we recommend you hire a licensed electrician to install a three-wire grounded outlet. If the control panel is not properly grounded, players may receive an electrical shock! After servicing any part on the control panel, check that the grounding wire is firmly secured to the inside of the control panel. After you have checked this, lock up the game.

**AC Power Connection.** Before you plug in the game, be sure that the game's power supply can accept the AC line voltage in your location. The line voltage requirements are listed in the first chapter of this manual.

**Disconnect Power During Repairs.** To avoid electrical shock, disconnect the game from the AC power before removing or repairing any part of the game. If you remove or repair the video display, be very careful to avoid electrical shock. High voltages continue to exist even after power is disconnected in the display circuitry and the cathode-ray tube (CRT). Do not touch the internal parts of the display with your hands or with metal objects! Always discharge the high voltage from the CRT before servicing it. Do this after you disconnect it from the power source. First, attach one end of a large, well-insulated, 18-gauge jumper wire to ground. Then momentarily touch the free end of the grounded jumper wire to the CRT anode by sliding the wire under the anode cap. Wait two minutes and do this again.

**Use Only Atari Parts.** To maintain the safety of your Atari game, use only Atari parts when you repair it. Using non-Atari parts or modifying the game circuitry may be dangerous, and could injure you and your players.

**Handle the CRT With Care.** If you drop the CRT and it breaks, it may implode! Shattered glass from the implosion can fly six feet or more.

**Use the Proper Fuses.** To avoid electrical shock, use replacement fuses which are specified in the parts list for this game. Replacement fuses must match those replaced in fuse type, voltage rating, and current rating. In addition, the fuse cover must be in place during game operation.

### CAUTION

**Properly Attach All Connectors.** Make sure that the connectors on each printed circuit board (PCB) are properly plugged in. The connectors are keyed to fit only one way. If they do not slip on easily, do not force them. If you reverse a connector, it may damage your game and void your warranty.

**Ensure the Proper AC Line Frequency.** Video games manufactured for operation on 60 Hz line power (used in the United States) must not be operated in countries with 50 Hz line power (used in Europe). If a 60 Hz machine operates on 50 Hz line power, the fluorescent line ballast transformer will overheat and cause a potential fire hazard. Check the product identification label on your machine for the line frequency required.

### ABOUT NOTES, CAUTIONS, AND WARNINGS

In Atari publications, notes, cautions and warnings have the following meaning:

**NOTE** — A highlighted piece of information.

**CAUTION** — Equipment and/or parts can be damaged or destroyed if instructions are not followed. You will void the warranty on Atari printed-circuit boards, parts thereon, and video displays if equipment or parts are damaged or destroyed due to failure of following instructions.

**WARNING** — Players and/or technicians can be killed or injured if instructions are not followed.

## C O N T E N T S

### 1 Installation

How to Use This Manual .....	1-1
Cabinet Equipment Requirements .....	1-2
Tools Required .....	1-2
Inspecting the Kit .....	1-3
Preparing the Cabinet for the Kit Installation .....	1-3
Assembling the Control Panel.....	1-3
Installing the Foot Pedal .....	1-5
Connecting the JAMMA Harness.....	1-6
Installing the World Rally Game PCB.....	1-7
Installing the Bezel, Decals, Labels, and Attraction Assembly .....	1-8
Adjusting the Volume .....	1-8
Setting the Coin and Game Options.....	1-8
Maximizing Earnings .....	1-8
Game Play .....	1-8

### 2 Self-Test and Troubleshooting

Introduction .....	2-1
Entering and Exiting the Self-Test .....	2-2
Monitor and General Status Screen .....	2-2
Coin Settings Display.....	2-2
Game Settings Display.....	2-2
Control Test.....	2-3
Troubleshooting.....	2-4

### 3 Parts Illustrations

See the List of Illustrations that follows.

### 4 Schematic Diagrams

See the List of Illustrations that follows.

## I L L U S T R A T I O N S

Figure 1-1	Locations of Control Panel Holes to be Drilled.....	1-5
Figure 1-2	Locations of Foot Pedal Holes to be Drilled.....	1-6
Figure 2-1	Monitor and General Status Screen ....	2-2
Figure 2-2	DIP Switch 1 Display (Coin Option Settings).....	2-2
Figure 2-3	DIP Switch 2 Display (Game Option Settings).....	2-3
Figure 2-4	Control Test Screen .....	2-4
Figure 3-1	World Rally Universal Kit .....	3-2
Figure 3-2	High/Low Gear Shifter Assembly .....	3-3
Figure 3-3	Foot Pedal Assembly (Two Views)....	3-4
Figure 3-4	360° Steering Wheel Assembly .....	3-6
Figure 3-5	World Rally Game PCB Assembly .....	3-7
Figure 3-6	JAMMA Filter PCB Schematic Diagram.....	3-8
Figure 3-7	JAMMA Filter PCB Assembly.....	3-10

## T A B L E S

Table 1-1	Equipment Requirements .....	1-2
Table 1-2	Contents of World Rally Kit.....	1-2
Table 1-3	JAMMA Pin and Wire Connections .....	1-4
Table 2-1	DIP Switch 1 Settings (Coin Settings)....	2-3
Table 2-2	DIP Switch 2 Settings (Game Options)...	2-4
Table 2-3	Troubleshooting Table.....	2-5

# Installation

## HOW TO USE THIS MANUAL

**T**HE WORLD RALLY™ conversion kit is a two-player alternating game for upright cabinets. If you own upright Pole Position® games previously made by Atari, Inc., we have provided detailed instructions for installing this kit into those games. These instructions are published in a supplement to this manual, part no. CO-391-02. Contact your Atari Games distributor if you would like a copy of this supplement. ♦ This manual provides informa-

tion for installing, testing, and troubleshooting the World Rally™ conversion kit. ♦ Chapter 1 describes how to install the World Rally kit in your cabinet. This chapter also describes game play. ♦ Chapter 2 contains self-test procedures and a troubleshooting table. The self-test is important in the World Rally game. You can troubleshoot the PC boards, main circuits, and controls using the screens in the self-test. ♦ Chapter 3 contains the kit parts illustrations.



**WARNING**

To avoid electrical shock, unplug the cabinet while installing the kit. After installation, plug the game only into a grounded 3-wire outlet.

**Cabinet Equipment Requirements**

**WARNING**

For safe use, you must install this World Rally kit in a standard Atari Games "family" cabinet, or in any cabinet that has received Underwriters Laboratories listing.

Table 1-1 lists the equipment required in the cabinet into which you are installing the World Rally kit.

**CAUTION**

Do not unplug or plug in the World Rally game printed-circuit board (PCB) edge connector while the power is on. You could seriously damage the PCB.

Equipment	Specification
Video Display	Color RGB monitor Separate positive horizontal and vertical sync or negative composite sync Horizontal mounting Horizontal frequency: 15.750 KHz Vertical frequency: 60 Hz Video input: 1V to 3V peak-to-peak positive polarity
Control Panel	Metal only
Speaker	8 Ω, 10 W
Coin Counter	+5 VDC or +12 VDC
Power Cord	Three-conductor with ground
Power Supply	+5 VDC ± 0.25V @ 5.0 amps minimum  +12 VDC @ 1.0 amp

**Table 1-1 Equipment Requirements**

**Tools Required**

- Drill with a 1/2-inch and 3/16-inch drill bits
- Phillips screwdriver
- Flat-blade screwdriver
- Socket wrench set and ratchet
- 1/2-inch hex wrench
- Wire cutters and strippers

Qty.	Description	Part No.
1	JAMMA Filter PC Board Assy.	A047292-01
1	Product I.D. Label	038158-01
1	FCC Compliance Label	039450-01
1	FBI Warning Label	042452-01
1	Black Bezel for Kits	049774-01
1	3/16-inch Polycarbonate Control Panel Cover	051656-01
2	Side Panel Decal	051932-01
1	Attraction Film	051933-01
1	Control Panel Decal	051934-01
1	Instruction Label	051937-01
4	.40-inch I.D. Split Ferrite Beads	141026-003
1	Snap-Action Switch	160044-001
1	High/Low Gear Shifter Assy.	171088-001
1	Single Foot Pedal Assy.	171122-0001
1	360° Steering Assy. with Mounting Pod and Hardware	171123-0001
1	World Rally Game PCB Assy.	155035-001
4	.281 I.D. x 1.25 O.D. x .059 Thick Flat Washers	175002-007
4	#10 Flat Washers	175014-1040
4	#10-24 Zinc Nut/Washer Assemblies	177026-0040
4	#1/4-20 Nut/Washer Assemblies	177026-0044
2	#10 Wire and Cable Ties	178032-002
1	Red Button Assembly	178237-001
1	Black "Start" Indicator Plate with Backing Strip	178283-011
2	1/2-inch Straight PCB Standoffs with Adhesive (for JAMMA Filter Bd.)	178373-0108
4	#10-24 x 3/4-inch Long Carriage Bolts	75-5112B
1	World Rally Universal Kit Installation Instructions	TM-391

Note: A JAMMA harness is not included in this kit. If your game cabinet does not already have a JAMMA harness installed in it, you can order this harness from Atari Games Customer Service. Also, packaging materials are not listed above.

**Table 1-2 Contents of World Rally Kit**



- Straight edge
- Squeegee
- X-ACTO™ knife
- Insulated wire connectors (if you are installing a new JAMMA harness)
- Carbon paper
- Saber saw
- File
- Bandsaw
- Tape or glue

## Inspecting the Kit

Check to see that you have all the parts listed in the kit parts list in Table 1-2. If any part is missing or damaged, contact your distributor with the World Rally kit serial number, part number, and description of the missing or damaged parts, and date received.

### CAUTION

*Legally distributed World Rally™ game PCBs have a small holographic “AAMA” label on them. If your game PCB does not have such a label, contact your Atari Games distributor before installing this kit.*

## Preparing the Cabinet for the Kit Installation

### WARNING

*To avoid electrical shock, unplug the cabinet while installing the kit. After installation, plug the game only into a grounded 3-wire outlet.*

1. Turn off power to the game, and unplug the power cord.
2. Remove the following from the cabinet:
  - Existing PCBs
  - Game harness, if it is not Japan Amusement Machinery Manufacturers Association (JAMMA)-compatible
  - Control panel decals, labels, and controls
  - Side decals, graphics, and adhesive. If the cabinet sides are damaged, repair them before putting on the new decals.

- Video display (monitor) shield, display bezel, attraction shield, and marquee.
3. Wipe down and vacuum the cabinet. Paint the cabinet, if required.

## Assembling the Control Panel

### Parts Needed for this Kit

To assemble the control panel, you need to decide on where to cut the control panel holes. Refer to Figure 1-1. Create a template sheet from that illustration. You will also need the following parts from the kit:

- Clear cover for the control panel
- Control panel decal
- Red button assembly
- Snap-action switch
- “Start” indicator plate
- High/low gear shifter
- Steering wheel with mounting pod and hardware
- Four #10 flat washers, #10-24 x ¾-inch-long black carriage bolts, and #10-24 nut/washer assemblies for the gear shifter

### Installing the Parts

1. Using carbon paper, transfer the design from the template to the control panel. Save the template.
2. Drill four ¼-inch holes in the metal control panel for the gear shifter mounting bolts.
3. Using a saber saw, carefully cut out the large hole for the gear shifter. Deburr the sharp edges with a file.
4. Drill four .343-inch holes for the four mounting bolts of the steering pod.
5. Drill two 1.187-inch holes — one for the start button and one for the center of the steering wheel assembly.
6. Lay the plexiglass cover over the top of the control panel and mark the outside shape of the panel on the plastic. Also mark the button hole as close as possible to the locations shown on the template.

Lastly, mark the positions of the four holes that will be used for securing the cover to the control panel. These four holes can be placed anywhere near the corners — wherever space permits.



**Solder Side****Component Side**

Color <sup>1</sup>	Signal	Pin	Pin	Signal	Color <sup>1</sup>
Brown <sup>2</sup>	POWER GND	<b>A</b>	<b>1</b>	POWER GND	Brown <sup>2</sup>
Brown <sup>2</sup>	POWER GND	<b>B</b>	<b>2</b>	POWER GND	Brown <sup>2</sup>
Red <sup>3</sup>	+5V DC	<b>C</b>	<b>3</b>	+5V DC	Red <sup>3</sup>
Red <sup>3</sup>	+5V DC	<b>D</b>	<b>4</b>	+5V DC	Red <sup>3</sup>
Orange	Not Used	<b>E</b>	<b>5</b>	Not Used	Orange
Yellow <sup>4</sup>	+12V DC	<b>F</b>	<b>6</b>	+12V DC	Yellow <sup>4</sup>
—	<b>Key</b>	<b>H</b>	<b>7</b>	<b>Key</b>	—
Violet/White <sup>5</sup>	COIN CTR 2	<b>J</b>	<b>8</b>	COIN CTR 1	Blue/White <sup>6</sup>
—	Not Used	<b>K</b>	<b>9</b>	Not Used	—
White	SPKR –	<b>L</b>	<b>10</b>	SPKR +	Brown
—	Not Used	<b>M</b>	<b>11</b>	Not Used	—
Green	VIDEO GREEN	<b>N</b>	<b>12</b>	VIDEO RED	Red
Brown	VIDEO SYNC (neg. composite sync)	<b>P</b>	<b>13</b>	VIDEO BLUE	Blue
—	Not Used	<b>R</b>	<b>14</b>	VIDEO GND	Black <sup>7</sup>
—	Not Used	<b>S</b>	<b>15</b>	SELF-TEST	White <sup>8</sup>
Orange	COIN SW2	<b>T</b>	<b>16</b>	COIN SW1	Yellow
—	Not Used	<b>U</b>	<b>17</b>	PLYR1 START	White/Black <sup>9</sup>
—	Not Used	<b>V</b>	<b>18</b>	Not Used	—
—	Not Used	<b>W</b>	<b>19</b>	Not Used	—
—	Not Used	<b>X</b>	<b>20</b>	Not Used	—
—	Not Used	<b>Y</b>	<b>21</b>	Not Used	—
—	Not Used	<b>Z</b>	<b>22</b>	ACCELERATOR	White/Green <sup>10</sup>
—	Not Used	<b>a</b>	<b>23</b>	SHIFTER	White/Blue <sup>11</sup>
—	Not Used	<b>b</b>	<b>24</b>	Not Used	—
—	Not Used	<b>c</b>	<b>25</b>	Not Used	—
Grey/White <sup>12</sup>	STEERING DIRECTION	<b>d</b>	<b>26</b>	STEERING CLOCK	Violet <sup>12</sup>
Black/White	SWITCH GND	<b>e</b>	<b>27</b>	SWITCH GND	Black/White
Black/White	SWITCH GND	<b>f</b>	<b>28</b>	SWITCH GND	Black/White

**Footnotes**

<sup>1</sup>The colors listed are for reference only. They are the colors used on the JAMMA harness available from Atari Games.

<sup>2</sup>Connect to the 5V GND (RTN) terminal on the power supply. However, if you have 12V GND, connect *one* of the wires at pin 1, 2, A, or B to the 12V GND terminal. If your power supply has a – Sense terminal, connect one wire to the – Sense.

<sup>3</sup>Connect to the +5V terminal on the power supply. However, if your power supply has a + Sense terminal, connect one wire to the + Sense.

<sup>4</sup>Connect to the +12V terminal of the power supply. If your coin counter(s) require 12V, also connect to the + side of the coin counter(s).

<sup>5</sup>If you want to install a second coin counter, connect this wire to one side of the right 12V coin counter. *Note: Do not use 24V counters.* Connect the + side to +5V or +12V on the power supply, as appropriate.

<sup>6</sup>Connect this wire to one side of the left 12V coin counter. *Note: Do not use 24V counters.* Connect the + side to +5V or +12V on the power supply, as appropriate.

<sup>7</sup>Note that the World Rally Game PCB was modified at the Atari Games factory to ground this pin. If this wire has become grounded and the video signal is no longer grounded, the monitor will display a jumbled video image.

<sup>8</sup>Use this wire if you want an external self-test switch. However, the kit already has a self-test switch on the game PCB. (If you connect an external self-test switch, turn off the switch on the PCB. Connect the wire to the N.O. terminal on the external self-test switch. Connect the common terminal of the switch to a GND wire.)

<sup>9</sup>Connect this wire (white/black) to the N.O. terminal on the start button. Connect the common terminal to a switch ground wire.

<sup>10</sup>Connect this wire (white/green) to the yellow wire supplied on the foot pedal assy. Connect the black wire on the foot pedal to a switch ground wire. Secure the green safety ground wire to a bare metal AC ground source.

<sup>11</sup>Connect this wire (white/blue) to the N.O. terminal on the shifter. Connect the common terminal of the switch to a switch ground wire. **NOTE: Improper connection of the shifter will cause it to work backwards, affecting game play and earnings!**

<sup>12</sup>Connect the grey/white wire (steering direction) to the white wire supplied with the steering assy. Connect the violet wire (steering clock) to the grey wire supplied with the steering assy. Connect the red wire on the steering assy. to +5V and the black wire to switch ground.

**Table 1-3 JAMMA Pin and Wire Connections**

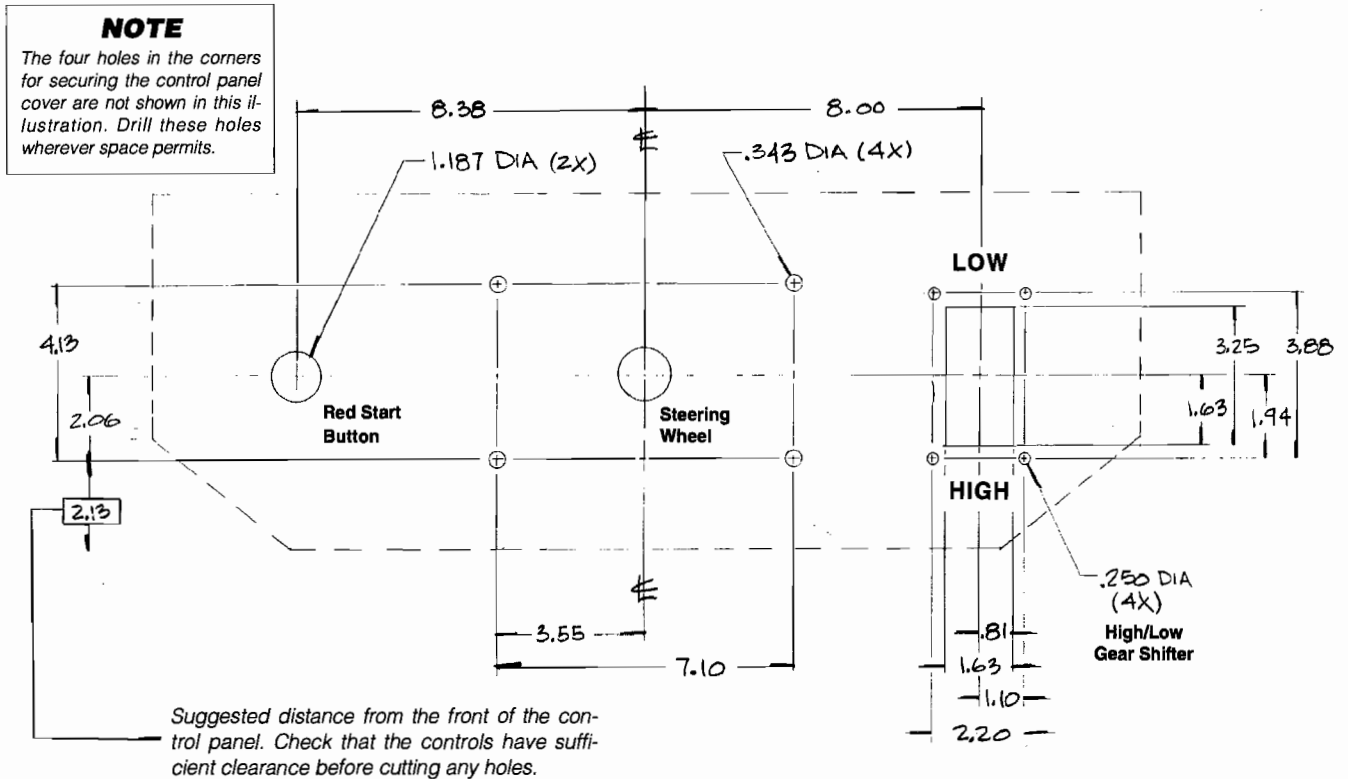

**Figure 1-1 Locations of Control Panel Holes to be Drilled**

- Using a bandsaw, cut the control panel cover to its correct outside shape.

### WARNING

*Wear safety glasses when drilling the plastic control panel cover. Use care to avoid shattering or chipping the plastic.*

- Tape or glue the template to the plexiglass cover. To start the saber saw cut, drill a 1/2-inch hole inside the steering wheel hole, the gear shifter cutout, and the button hole.
- Saw out the large hole for the shifter and the button hole.
- Drill the four 1/4-inch holes that will be used to mount the cover to the control panel and the 1/4-inch bolt holes to mount the shifter.
- To prevent injury, carefully deburr all the edges of the plexiglass cover.
- Install the control panel decal on the control panel. Use a sharp X-ACTO knife to trim the outside edge and to cut out the holes for the controls.

- Install the cover on the control panel with the four 3/4-inch-long carriage bolts, washers, and nut/washer assemblies.

- Install the steering wheel pod using the 1/4-20 hardware supplied with it.
- Install the red button assembly with its "Start" indicator plate and snap-action switch.
- Install the gear shifter with its #10-24 nut/washer assemblies and 3/4-inch-long carriage bolts.

For maintenance and servicing information on the controls, refer to Chapter 2 of this manual.

## Installing the Foot Pedal

### Parts Needed from this Kit

To install the foot pedal on the lower front of your game cabinet, you need the following parts:

- Foot pedal assembly
- Four fender washers and nut/washer assemblies

## Installing the Parts

1. Draw a template using the hole dimensions and locations shown in Figure 1-2 of this manual. Using carbon paper, transfer the foot pedal mounting pattern from the template to the cabinet.
2. Drill four  $\frac{3}{8}$ -inch corner holes and a  $\frac{1}{4}$ -inch center hole in the cabinet front.
3. Feed the pedal harness through the large center hole. Insert the foot pedal's threaded studs into the four small corner holes.
4. From the inside of the cabinet, install the four fender washers and nut/washer assemblies onto the threaded studs of the pedal.

## Connecting the JAMMA Harness

1. If your game cabinet does not already have a JAMMA harness, install a JAMMA harness in the cabinet. To purchase a JAMMA harness, contact the Atari Games Customer Service office closest to you.
2. Install the two pairs of split beads on the harness as close to the PCB edge connector as possible. Hold the beads on the harness with the two tie wraps included in the kit.

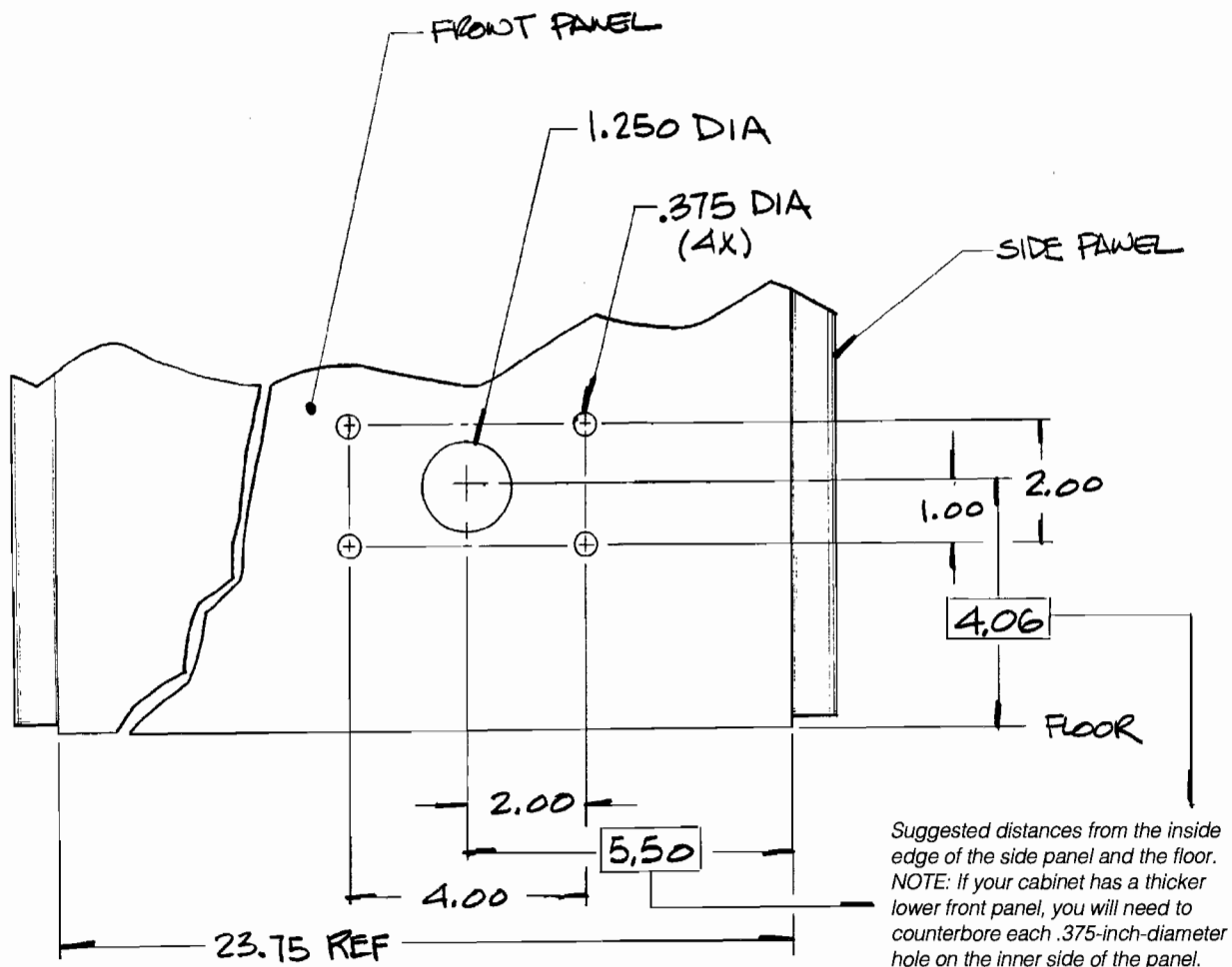

**Figure 1-2 Locations of Foot Pedal Holes to be Drilled**

**CAUTION**

*You must install the split beads and the JAMMA Filter PCB on the JAMMA harness to meet FCC requirements. (These parts are included in the kit.)*

- Using Table 1-3 for wiring information, connect the JAMMA harness to existing component harnesses. Use crimp splices or butt soldering.

**WARNING**

*Do not simply tie the wires together. If you do, you could cause intermittent problems, loose connections, oxidation, or a fire.*

**Connecting Power Wires**

- Connect the wires on the JAMMA harness to the wires for the power supply, as shown in Table 1-3. The World Rally kit requires +5V and +12V. The -5V is not needed and should *not* be used. Tie off any other voltage wires on the power supply besides +5V, -5V, and +12V.

There is more than one wire for each voltage in the JAMMA harness. Use more than one wire for each voltage (connecting them as described in Table 1-3) so that the power wiring does not overload and burn.

**Connecting Video Display Wires****NOTE**

*The JAMMA harness provides only negative composite sync.*

Connect the wires designated for the red, green and blue video guns along with the sync and ground wires, according to Table 1-3.

**Connecting Coin Door Wires**

- Connect the wires on the JAMMA harness to the coin switches and meter according to Table 1-3.
- Connect one terminal of the door lamps to one of the BK/W wires. Connect the other terminal of the door lamps to the R wire supplying +5V.

**NOTE**

*Do not use -5V for the coin door lamps.*

Some games have separate power supply outputs for the coin door lamps. If you choose to use these outputs, make sure you connect both terminals of each lamp to the terminals on the power supply.

**Connecting the Control Wires**

Connect the gear shifter, foot pedal, steering wheel, and button harnesses to the JAMMA harness using crimp splices or butt soldering, according to the information in Table 1-3.

**Grounding the Cabinet**

Find the ground lead (green) of the 115V input power line. Connect this lead in daisy-chain fashion to a bare metal part of the coin door, the control panel, the foot pedal, the video display, and the power supply. This AC ground must be of #18 AWG wire or larger.

**WARNING**

*For the safety of players, you must connect the green ground wire as indicated above.*

**Checking the JAMMA Connections**

Before plugging in the game PCB, turn on the power to the game, and check +5 Volts on pins 3, 4, C, and D of the JAMMA connector; +12 Volts on pins F and 6; and -5 Volts on pins E and 5.

Check that the video display and the attraction lamp have power. Now turn off the power to the game.

**Installing the World Rally Game PCB**

- After you have checked the power on the JAMMA connector (above), install the World Rally game board in the cabinet. Use the four screws and standoffs supplied with the game board to mount it onto the wood cabinet surface.
- Plug the JAMMA Filter PCB into the game board. Install the ½-inch standoffs with adhesive to support the Filter PCB.
- Connect the JAMMA harness connector to the Filter PCB.
- Secure the JAMMA harness away from the PCB with cable ties.
- Turn on the power to the game. Check that the game PCB functions. If a video picture is not present, see Chapter 2.

## Installing the Bezel, Decals, Labels, and Attraction Assembly

### Installing the Display Bezel

Find the cardboard display bezel in the kit. This bezel can accommodate both 19-inch and 25-inch video displays. Follow the instructions on the back of the bezel, and cut the hole and outside edges as required. Then find the game instructions label in the kit, and adhere that label to the bottom center of the bezel.

### Installing the Product ID and FCC Label

Place the product ID label (part no. 038158-01) and FCC compliance label (part no. 039450-01) on the back of the cabinet.

### Installing the Side Panel Decals

Find the side panel decals in the kit. Wet the left and right side panels of the cabinet with slightly soapy water. Then position the decals on the side panels of the cabinet. Remove any wrinkles in the artwork using a squeegee. Allow the sides to dry.

### Installing the Attraction Assembly

Find the World Rally attraction film in the kit (the attraction shield should be reused from your cabinet). Using the existing shield as a template, cut the film to size, if necessary. Install them in the cabinet attraction assembly.

## Adjusting the Volume

This game has a volume control potentiometer on the game printed-circuit board. To adjust the volume, turn the knob located near the PCB's edge connector.

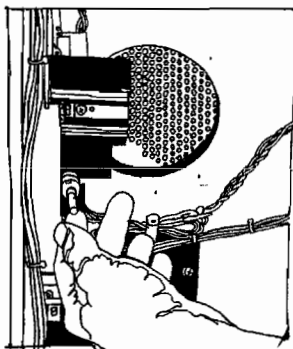

## Setting the Coin and Game Options

Set the coin and game options in the self-test. See Chapter 2 for information about the option settings.

## Maximizing Earnings

For maximum earnings, regularly maintain your World Rally game. When you set up the game and when you collect money, use all the screens in the self-test procedure — especially the Control Test.

## Game Play

This section describes the theme of the World Rally game and the game play features.

### Introduction

World Rally™ is a road rally-themed driving game. Licensed by Gaelco of Barcelona, Spain, it is suitable for both street and arcade locations. World Rally is a one- or two-player alternating driving game. Controls include a steering wheel on a mounting pod, a high/low gear shifter assembly, and an accelerator pedal.

### Game Play Description

Players select one of four rallies to start, each progressively more difficult than the one before. A rally is composed of three stages, offering a variety of different track layouts and road surfaces. Asphalt, dirt, night driving and snow-covered roads require players to adjust their driving skills accordingly.

Players maneuver their way through hairpin curves, jumps, bridges, puddles, and other obstacles. Completing each stage within the 60-second time limit allows players to advance to the next stage for free. After the finish of each stage, and at the completion of all 12 stages, players' times are displayed and compared with other top drivers.



# Self-Test and Troubleshooting

## INTRODUCTION

**T**HIS CHAPTER contains a description of the self-test and two troubleshooting tables for your World Rally™ game. Use the self-test procedure to check the condition of the game circuitry and controls. ♦ You will see the self-test information on the video display. You

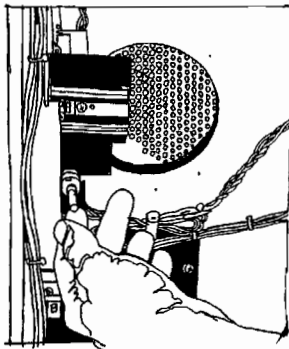

do not need any additional equipment to perform the self-test. You should perform the self-test when you first set up the game, each time you collect the money, or when you suspect game failure. ♦ This chapter shows the screens in the self-test and explains each of the tests.

## Entering and Exiting the Self-Test

To enter the self-test, push switch toggle 1 on DIP Switch 2 to the on position (located on the game PCB). Then turn the power to the game off and on again. See Figure 3-5 of this manual, which highlights the locations of DIP Switches 1 and 2.

Exit the self-test by returning this switch to the off position. Then turn the power to the game off and on again.

## Monitor and General Status Screen

Use this screen to see the monitor colors and the general status of the electronics (see Figure 2-1).

### Monitor Test

The color strips in the center should be four bands (green, red, blue, and black/white from top to bottom), each with a color scale of 15 blocks ranging from dark to bright, left to right. If the screen does not match this description, adjust the video display as described in the video display manual.

### Electronics Status

The four lines at the bottom of the screen show the version of the software, and the status of the RAM, ROM, and coprocessor. Advance to the next screen by pressing the Start button.

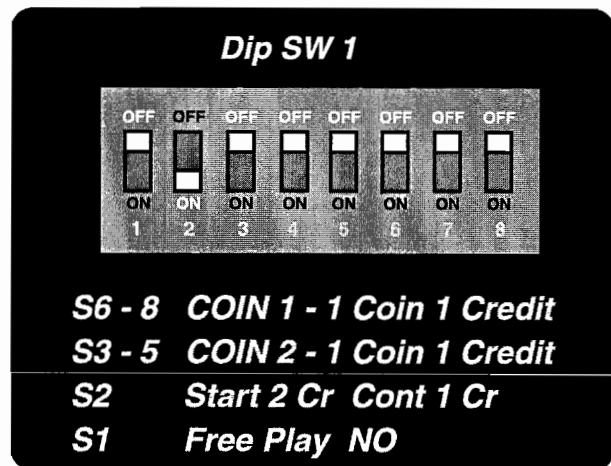

**Figure 2-1 Monitor and General Status Screen**

## Coin Settings Display

Use this screen to see how all the dual-inline-package (DIP) switch toggles on DIP Switch 1 on the game PCB are set. You can view and change the coin options on this screen, shown in Figure 2-2. The coin option settings are explained in Table 2-1.

To change a setting, slide the appropriate toggle on DIP Switch 1 to on or off. The screen will immediately display the change in status. Advance to the next screen by pressing the Start button.



**Figure 2-2 DIP Switch 1 Display (Coin Option Settings)**

## Game Settings Display

Use this screen to see how all the DIP switch toggles on DIP Switch 2 on the game PCB are set. You can view and change the game options on this screen, shown in Figure 2-3. The game option settings are explained in Table 2-2.

To change a setting, slide the appropriate toggle on DIP Switch 2 to on or off. The screen will immediately display the change in status. Advance to the next screen by pressing the Start button.

Option	Switch Settings			Result	
Free Play	1 Off			No ✓	
	1 On			Yes	
Start/Continue Setting	2 Off			1 credit to start/1 credit to continue	
	2 On			2 credits to start/1 credit to continue ✓	
Game Cost	6 Off	7 Off	8 Off	1 coin for 1 credit ✓	For SW1 or left mechanism
	6 Off	7 Off	8 On	1 coin for 2 credits	
	6 Off	7 On	8 Off	1 coin for 3 credits	
	6 Off	7 On	8 On	1 coin for 4 credits	
	6 On	7 Off	8 Off	1 coin for 5 credits	
	6 On	7 Off	8 On	1 coin for 6 credits	
	6 On	7 On	8 Off	2 coins for 3 credits	
	6 On	7 On	8 On	3 coins for 4 credits	
Game Cost	3 Off	4 Off	5 Off	1 coin for 1 credit ✓	For SW2 or right mechanism
	3 Off	4 Off	5 On	2 coins for 1 credit	
	3 Off	4 On	5 Off	3 coins for 1 credit	
	3 Off	4 On	5 On	4 coins for 1 credit	
	3 On	4 Off	5 Off	5 coins for 1 credit	
	3 On	4 Off	5 On	6 coins for 1 credit	
	3 On	4 On	5 Off	3 coins for 2 credits	
	3 On	4 On	5 On	4 coins for 3 credits	

✓ *Manufacturer's recommended settings.*

**Table 2-1 DIP Switch 1 Settings (Coin Settings)**

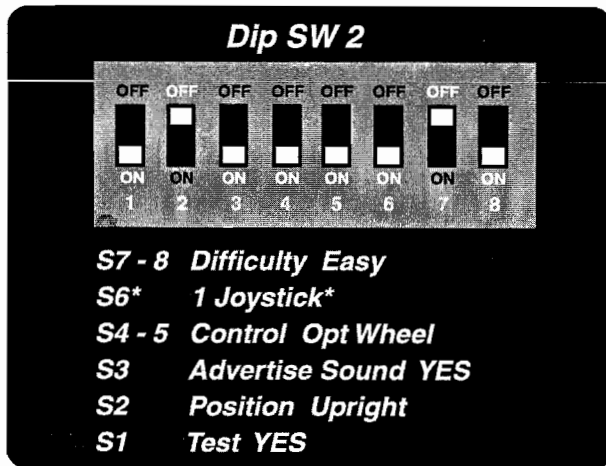

**Figure 2-3 DIP Switch 2 Display (Game Option Settings)**

## Control Test

Use this screen to check all the coin switches, control panel switches, steering wheel, and foot pedal in this game (see Figure 2-4).

*\*Ignore the S6 setting. Setting it to either 1 Joystick or 2 Joysticks is irrelevant, because this kit does not use joysticks.*

To check the functioning of each switch, activate it and watch the corresponding graphic change.

### NOTE

*Player 1 is the start button. F1 represents the foot pedal, and F2 is the gear shifter. The Player 2 start button and the three graphics below it are not used by the game software. Coins 1 is the left coin mechanism, and Coins 2 is the right one.*

If the messages or graphics do not appear correctly, check the harness connections, switches, steering wheel, and foot pedal.

Advance to the attract mode by simultaneously pressing the foot pedal and the start button. Permanently exit the self-test by moving switch toggle 1 on DIP Switch 1 to the off position. Then turn the power to the game off and on again. The game will now stay in the attract mode.

Option	Switch Settings		Result
Game Difficulty	7 Off	8 Off	1 (Normal) ✓
	7 Off	8 On	2 (Easy)
	7 On	8 Off	3 (Hard)
	7 On	8 On	4 (Hardest)
No. of Joysticks Installed	6 On		1 joystick
	6 Off		2 joysticks (Either of the S6 settings is irrelevant for this kit, so ignore how this switch is set. This kit does not use joysticks.)
Driving Control Installed	4 Off	5 Off	Joystick
	4 Off	5 On	270° steering wheel (potentiometer)
	4 On	5 On	360° steering wheel (optical sensor) ✓
Sound During Attract?	3 Off		No
	3 On		Yes ✓
Type of Cabinet	2 On		Cocktail table
	2 Off		Upright game ✓
Self-Test Mode On	1 Off		No ✓
	1 On		Yes (You must power off the game before it will enter the self-test mode or stay in the attract mode.)

✓ *Manufacturer's recommended settings.*

**Table 2-2 DIP Switch 2 Settings (Game Options)**

## Troubleshooting

Table 2-3 (troubleshooting) in this chapter can help you pinpoint problems in your game. This table lists possible sources of problems in various parts of the game.

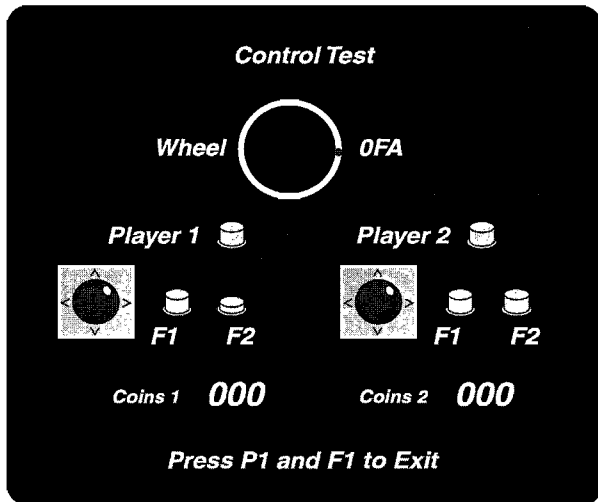

**Figure 2-4 Control Test Screen**

<b>Problem</b>	<b>Suggested Action</b>
<b>Coin Mechanism Problem</b>	<ol style="list-style-type: none"> <li>1. Check the wiring to the coin switch and counter.</li> <li>2. Test the coin switch with the sound test screen in the self-test.</li> </ol>
<b>Game Play Problem</b>	<ol style="list-style-type: none"> <li>1. Check the harness and connectors.</li> <li>2. Perform the self-test.</li> <li>3. Check the voltage levels on the PCB.</li> </ol>
<b>Control Problems</b>	<ol style="list-style-type: none"> <li>1. Has the steering wheel, gear shifter, or foot pedal been lubricated? If not, lubricate it. Refer to Figures 3-2 through 3-4 for exploded parts illustrations.</li> <li>2. Check the harnesses and connectors.</li> <li>3. Check the switches and the optical sensor on the steering wheel by using the Control Test screen in the self-test procedure.</li> <li>4. If you took the control apart, have you reassembled it correctly?</li> <li>5. Make sure all the parts on the controls are in good repair. Repair or replace parts.</li> </ol>
<b>Sound Problem</b>	<ol style="list-style-type: none"> <li>1. Is the speaker volume turned up? (Volume is adjusted on the game PCB.)</li> <li>2. Check the voltage on the game PCB edge connector.</li> <li>3. Check the wiring from the PCB to the speaker.</li> <li>4. Check the voltage level to the PCB.</li> <li>5. Replace the speaker.</li> </ol>
<b>Video Display Problem</b> Screen is dark.	<ol style="list-style-type: none"> <li>1. Is the game plugged in?</li> <li>2. Is the game turned on?</li> <li>3. Are the connections good?</li> <li>4. Is the line fuse good?</li> <li>5. Is the display brightness turned up?</li> <li>6. Are the edge connectors on the game PCB and JAMMA Filter PCB tightly connected?</li> <li>7. Check all of the items below. If you answer <i>no</i> to any question, you have a problem with the video display, not with the game circuitry. See your video display service manual. <ol style="list-style-type: none"> <li>a. Do you have power to the video display?</li> <li>b. Are the video display's filaments lit?</li> <li>c. Do you have high voltage to the video display?</li> </ol> </li> <li>8. Are the voltage levels to the video display PCB correct? (Power voltage is 100 VAC or 110 VAC, depending on the type of video display. Video signal voltage is 0.5 to 3.5 Volts.)</li> <li>9. If the level is not correct, check the connectors and the harness.</li> </ol>
Only a colored screen appears.	You probably have a serious RAM problem.
Display area wavers or is too small.	<ol style="list-style-type: none"> <li>1. Do you have correct power voltage to the video display PCB?</li> <li>2. Do you have correct high voltage to the video display?</li> </ol>
Picture is wavy.	<ol style="list-style-type: none"> <li>1. Is the monitor ground connected to the monitor?</li> <li>2. Are the sync inputs connected properly?</li> </ol>
Picture is upside down.	Check DIP Switch 2, toggle 2, on the game PCB. This toggle should be in the off position for a normal screen in an upright game. Another possibility is if you serviced the display, you may have connected the wires incorrectly. Switch the horizontal or vertical yoke wires on the display.
Convergence, purity or color problems.	Use the first screen in the game's self-test to adjust the video display. Use the adjustment procedures in your video display manual.
Picture is not centered.	Use the centering procedures in your video display manual.

**Table 2-3 Troubleshooting Table**

**N O T E S**



# Parts Illustrations

## INTRODUCTION

**T**HIS CHAPTER provides information you need to order replacement parts for your kit. All the common hardware parts sold with this kit, such as screws, nuts, washers, and so on, are included in these parts illustrations. In addition, the JAMMA Filter PCB schematic diagram is included in this chapter. ♦ When you order parts,

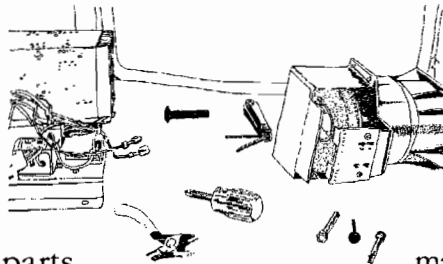

give the part number, part name, the number of this manual, and the serial number of your kit. With this information, we can fill your order rapidly and correctly. We hope this will create less downtime and more profit from your games. Atari Games Customer Service phone numbers are listed on the inside front cover of this manual.

**Figure 3-1 World Rally Universal Kit  
A051940-01 B**

**Parts List**

<b>Quan- tity</b>	<b>Description</b>	<b>Part No.</b>	<b>Quan- tity</b>	<b>Description</b>	<b>Part No.</b>
1	JAMMA Filter PC Board Assy.	A047292-01	4	.281-Inch I.D. x 1.25 O.D. x .059- Thick Flat Washers	175002-007
1	Product I.D. Label	038158-01	4	#10 Flat Washers	175014-1040
1	FCC Compliance Label	039450-01	4	#10-24 Zinc Nut/Washer Assemblies	177026-0040
1	FBI Warning Label	042452-01	4	#1/4-20 Nut/Washer Assemblies	177026-0044
1	Black Bezel for Kits	049774-01	2	#10 Wire and Cable Ties	178032-002
1	1/8-Inch Polycarbonate Control Panel Cover	051656-01	1	Red Button Assembly	178237-001
2	Side Panel Decal	051932-01	1	Black "Start" Indicator Plate with Backing Strip	178283-011
1	Attraction Film	051933-01	2	1/2-Inch Straight PCB Standoffs with Adhesive (for JAMMA Filter Bd.)	178373-0108
1	Control Panel Decal	051934-01	4	#10-24 x 3/4-Inch Long Carriage Bolts	75-5112B
1	Instruction Label	051937-01	1	World Rally Universal Kit Installation Instructions	TM-391
4	.40-Inch I.D. Split Ferrite Beads	141026-003			
1	Snap-Action Switch	160044-001			
1	High/Low Gear Shifter Assy.	171088-001			
1	Single Foot Pedal Assy.	171122-0001			
1	360° Steering Assy. with Mounting Pod and Hardware	171123-0001			
1	World Rally Game PCB Assy.	155035-001			

*Note: A JAMMA harness is not included in this kit. If your game cabinet does not already have a JAMMA harness installed in it, you can order this harness from Atari Games Customer Service.*

*Also, packaging materials are not listed above.*

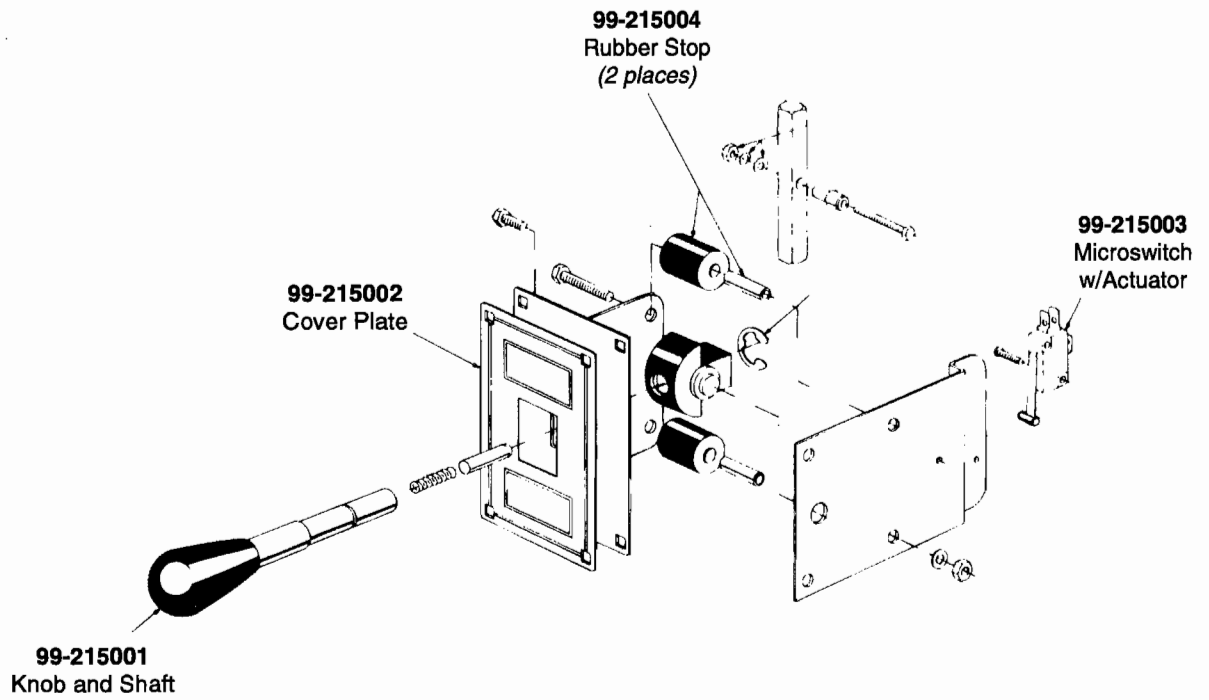

**Figure 3-2 High/Low Gear Shifter Assembly**  
**171088-001**

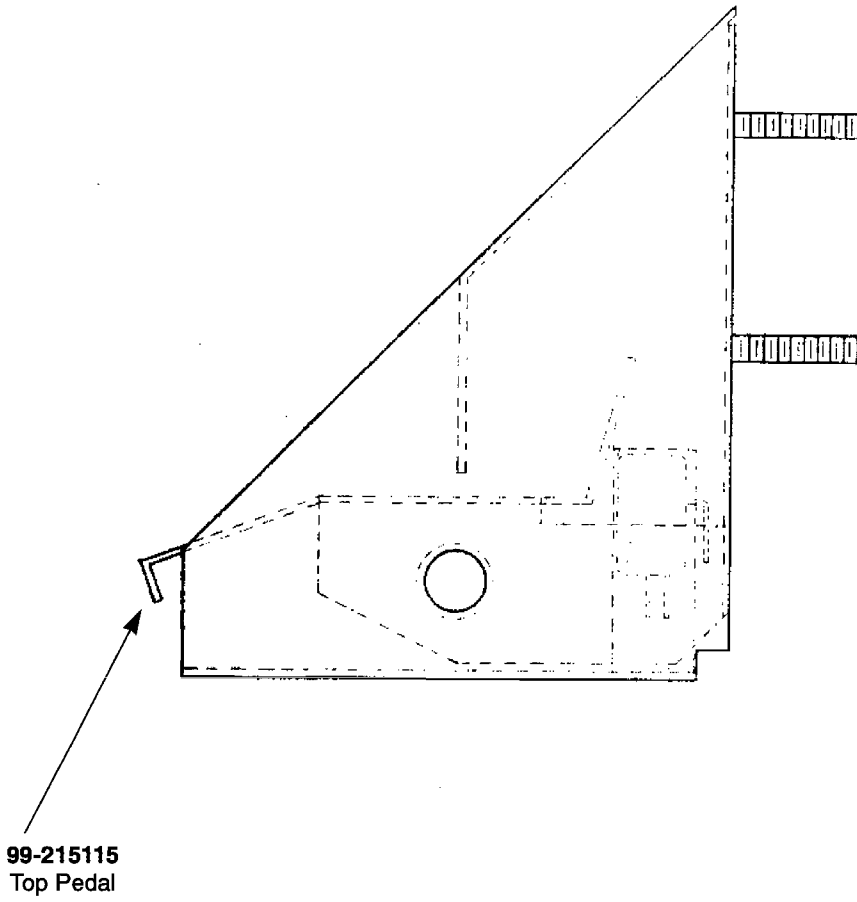

**Figure 3-3 Foot Pedal Assy. (Side View)**  
**171122-0001**

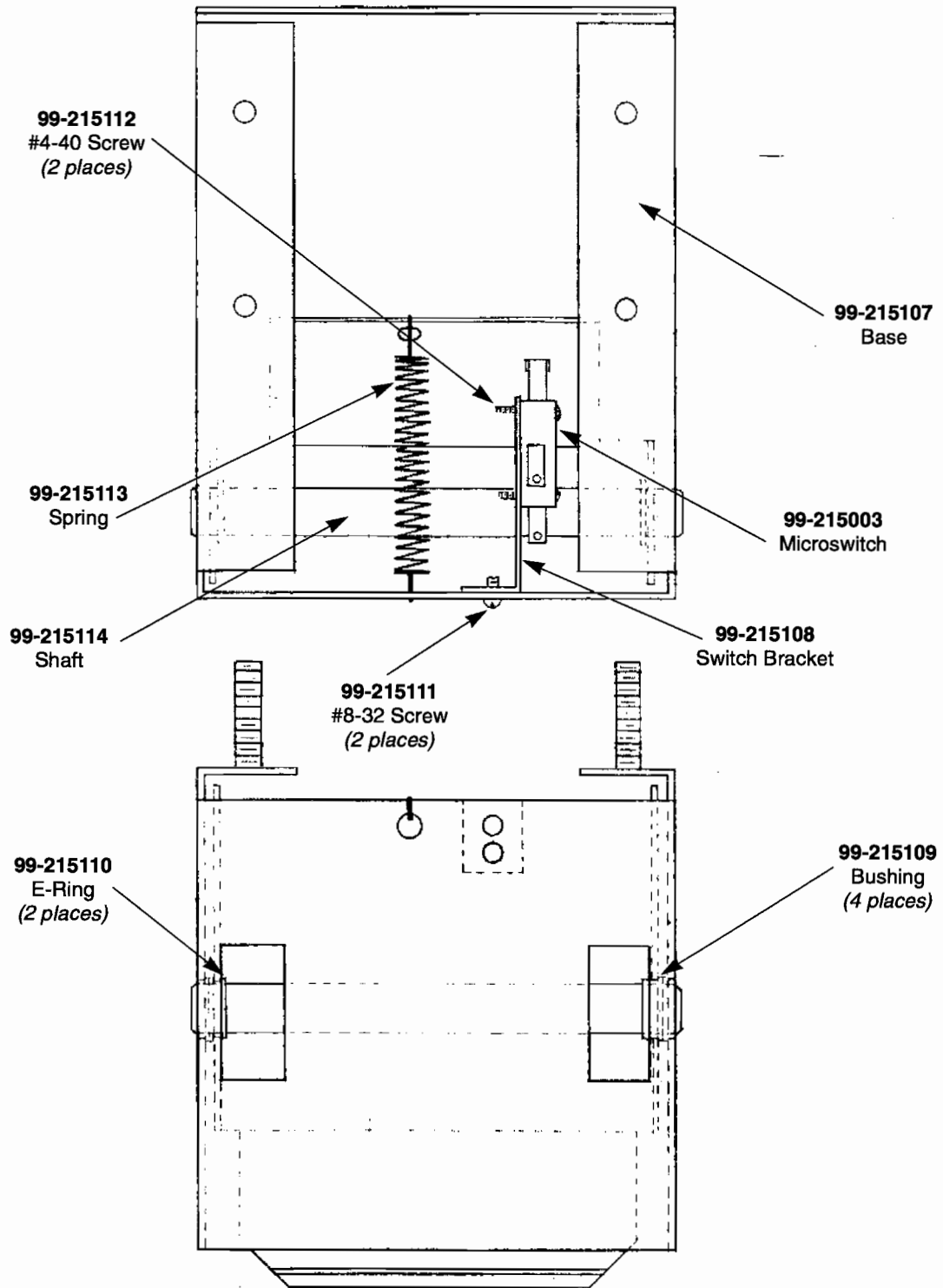

**Figure 3-3 Foot Pedal Assy. (Bottom and Top Views)**  
**171122-0001**

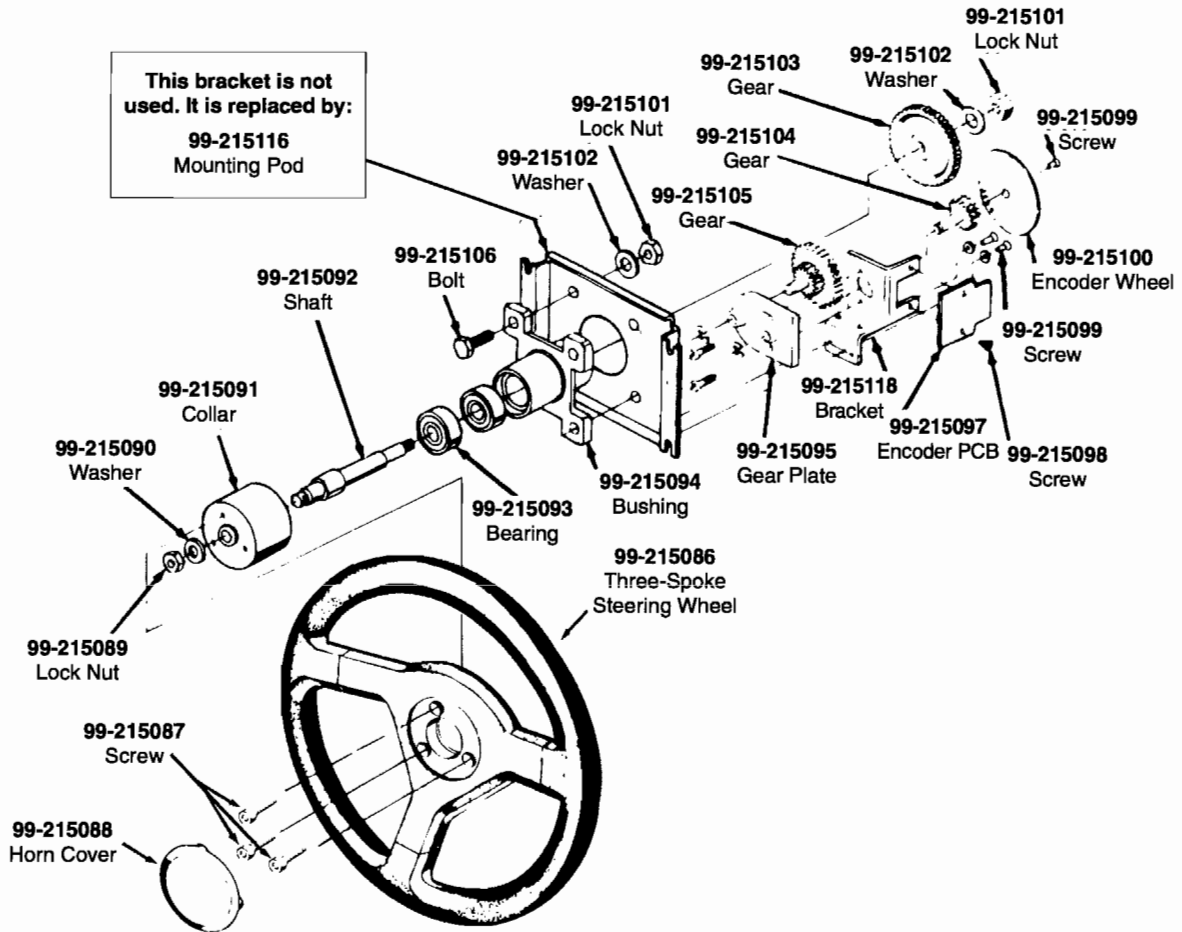

**Figure 3-4 360° Steering Wheel Assembly**  
171123-0001



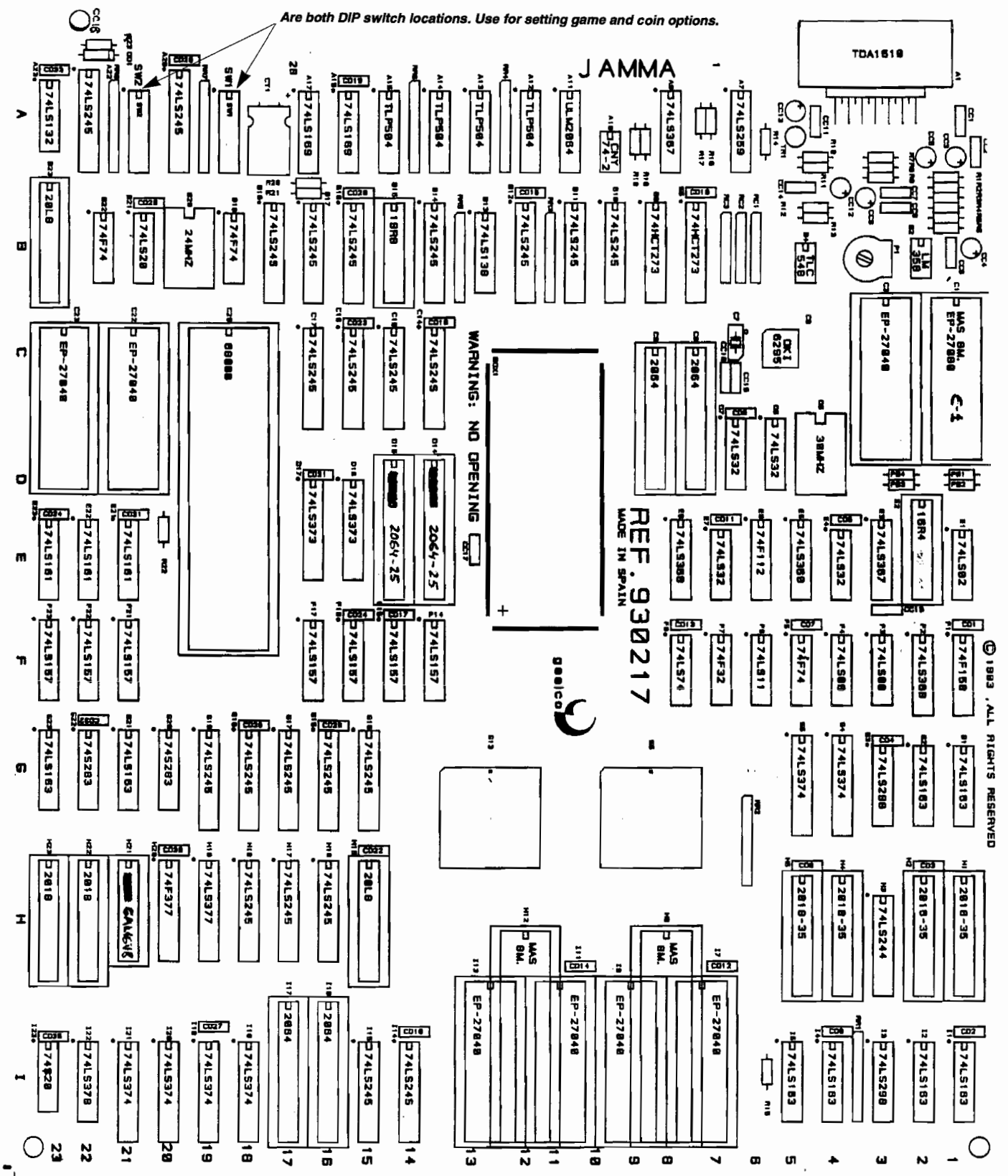

Figure 3-5 World Rally Game PCB Assembly 155035-001

FROM GAME BOARD

- J1
- 1 O — GND
- 2 O — GND
- 3 O — J1+5V
- 4 O — J1+5V
- 5 O — J1+5V
- 6 O — J1+12V
- 7 O — KEY
- 8 O — J1CNTR2
- 9 O — J1LOCK2
- 10 O — J1SPKR1-
- 11 O — J1AUDGND
- 12 O — J1GREEN
- 13 O — J1SYNC
- 14 O — J1SERV
- 15 O — J1TILT
- 16 O — J1RCOIN
- 17 O — J1START2
- 18 O — J1UP2A
- 19 O — J1DOWN2A
- 20 O — J1LEFT2A
- 21 O — J1RT2A
- 22 O — J1FIRE2
- 23 O — J1UP2B
- 24 O — J1DOWN2B
- 25 O — J1LEFT2B
- 26 O — J1RT2B
- 27 O — GND
- 28 O — GND
- A O — GND
- B O — GND
- C O — J1+5V
- D O — J1+5V
- E O — J1+5V
- F O — J1+12V
- H O — KEY
- J O — J1CNTR1
- K O — J1LOCK1
- L O — J1SPKR1+
- M O — J1AUD+
- N O — J1RED
- P O — J1BLUE
- R O — J1VIDGND
- S O — J1SLFTST
- T O — J1LCOIN
- U O — J1START1
- V O — J1UP1A
- W O — J1DOWN1A
- X O — J1LEFT1A
- Y O — J1RT1A
- Z O — J1FIRE1
- AA O — J1UP1B
- BB O — J1DOWN1B
- CC O — J1LEFT1B
- DD O — J1RT1B
- EE O — GND
- FF O — GND

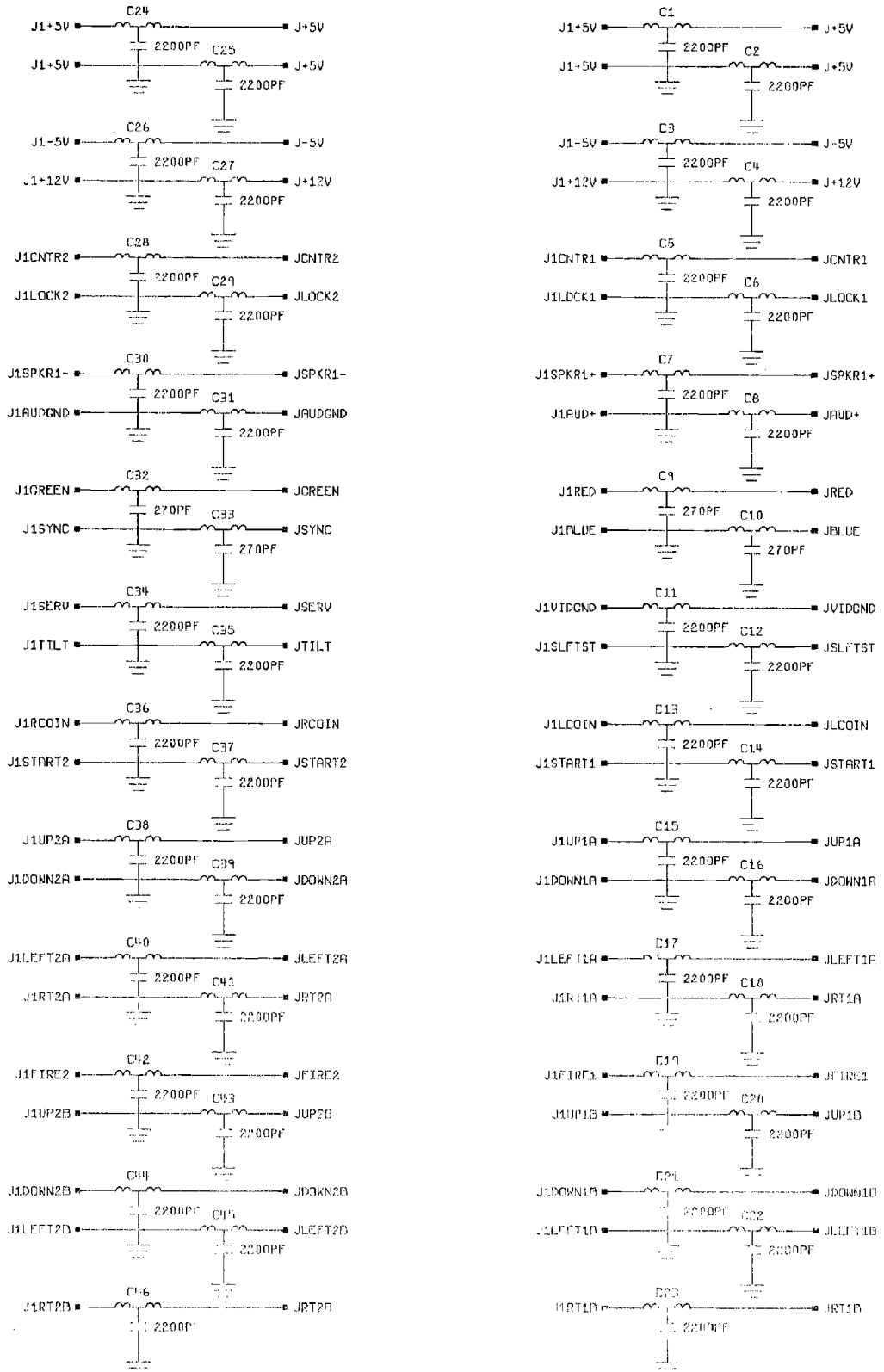

Figure 3-6 JAMMA Filter PCB Schematic Diagram

A047292-01 B

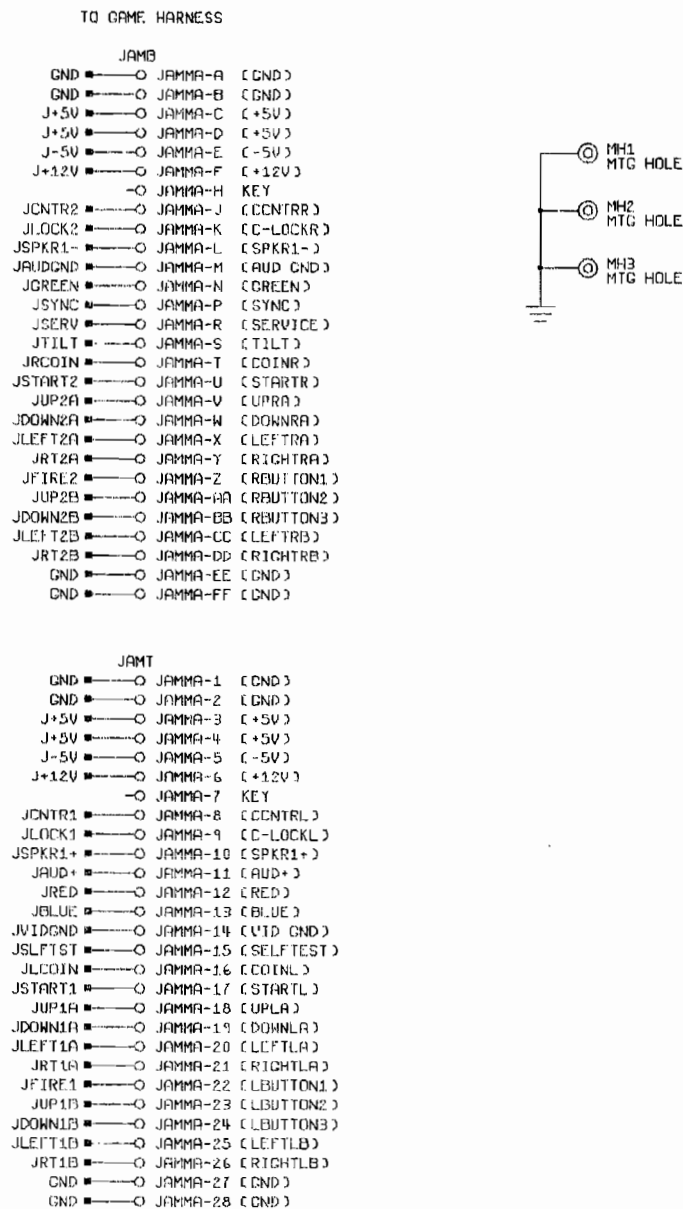
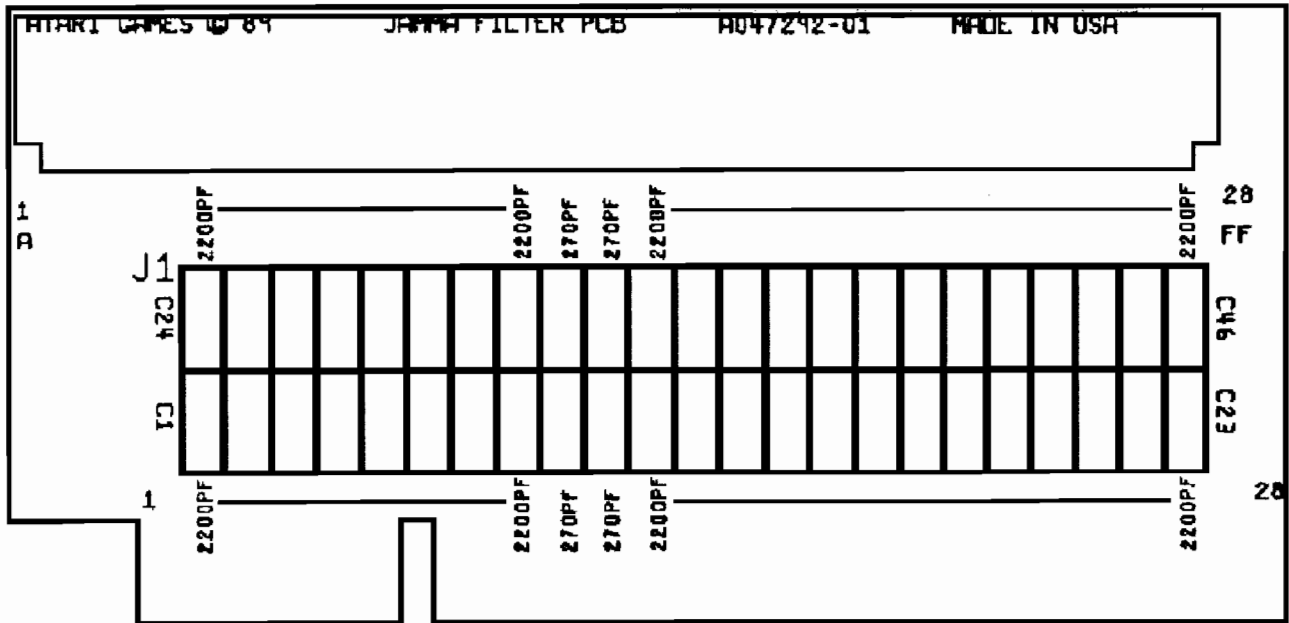

Figure 3-6 JAMMA Filter PCB Schematic Diagram, Continued

A047292-01 B



**Figure 3-7 JAMMA Filter PCB Assembly  
A047292-01 B**

**JAMMA Filter PCB Assembly  
Parts List**

Designator	Description	Part No.	Designator	Description	Part No.
C1-8	2200 pF, 50V, 3-Pin EMI Filter Cap.	140006-222	C32, C33	270 pF, 50V, 3-Pin EMI Filter Cap.	140006-271
C9, C10	270 pF, 50V, 3-Pin EMI Filter Cap.	140006-271	C34-46	2200 pF, 50V, 3-Pin EMI Filter Cap.	140006-222
C11-31	2200 pF, 50V, 3-Pin EMI Filter Cap.	140006-222	J1	Connector, 56 Ckt., .156 Ctr, RT	179240-056

# Warranty

Seller warrants that its printed-circuit boards and parts thereon are free from defects in material and workmanship under normal use and service for a period of ninety (90) days from date of shipment. Seller warrants that its video displays and laser-video disc players (in games supplied with displays and video-disc players) are free from defects in material and workmanship under normal use and service for a period of thirty (30) days from date of shipment. None of the Seller's other products or parts thereof are warranted.

If the products described in this manual fail to conform to this warranty, Seller's sole liability shall be, at its option, to repair, replace, or credit Buyer's account for such products which are returned to Seller during said warranty period, provided:

- (a) Seller is promptly notified in writing upon discovery by Buyer that said products are defective;
- (b) Such products are returned prepaid to Seller's plant; and
- (c) Seller's examination of said products discloses to Seller's satisfaction that such alleged defects existed and were not caused by accident, misuse, neglect, alteration, improper repair, installation, or improper testing.

In no event shall Seller be liable for loss of profits, loss of use, incidental or consequential damages.

*Except for any express warranty set forth in a written contract between Seller and Buyer which contract supersedes the terms herein, this warranty is expressed in lieu of all other warranties expressed or implied, including the implied warranties of merchantability and fitness for a particular purpose, and of all other obligations or liabilities on the Seller's part, and it neither assumes nor authorizes any other person to assume for the Seller any other liabilities in connection with the sale of products by Seller.*

The use of any non-Atari parts may void your warranty, according to the terms of the warranty. The use of any non-Atari parts may also adversely affect the safety of your game and cause injury to you and others. Be very cautious in using non-Atari-supplied components with our games, in order to ensure your safety.

Atari distributors are independent, being privately owned and operated. In their judgment they may sell parts or accessories other than Atari parts or accessories. Atari Games Corporation cannot be responsible for the quality, suitability or safety of any non-Atari part or any modification including labor which is performed by such distributor.





**Atari Games Corporation**

675 Sycamore Drive

Milpitas, CA 95035

U.S.A.