



UNDERCOVER COPS

OWNERS MANUAL

VIDEO GAME OPERATOR:

Don't Get Involved In A Federal Crime. Don't Buy Or Operate Copy Or Unauthorized Boards In Your Games.

Warning

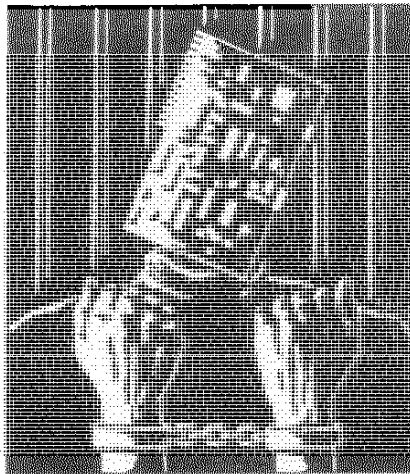

Every operator who buys or operates a counterfeit or unauthorized board (imported or domestic) is contributing to the end of our industry and committing a **FEDERAL CRIME**.

New criminal laws have recently been enacted that provide for maximum penalties of \$250,000 or five years in prison or both, per offense. **EACH GAME IS A SEPARATE OFFENSE.**



WARNING

Federal law provides severe civil and criminal penalties for the unauthorized reproduction, distribution, or exhibition of copyrighted audiovisual works and video games.

The Federal Bureau of Investigation investigates allegations of criminal copyright infringement.

If you have any information about any unauthorized games in the United States, contact your local FBI or,

American Amusement Machine Association

205 The Strand
Suite 3
Alexandria, Virginia 22314
(703) 548-8044

All information will be treated in confidence.

SAFETY

The following topics should be carefully studied to insure maximum reliability and safety for both serviceman and customer. Shock Hazard: The high voltage present on the monitor may be very dangerous. Extreme caution must be used when working with or around the monitors. Be certain that the grounding strap is attached to the monitor frame. The picture tube in the monitor is also a hazard and should be handled with care. Do not strike, scratch, or subject the tube to more than moderate pressure as it may implode causing serious injury from flying glass. Be certain that the control panel, power supply monitor, and coin door are all properly grounded to the ground wire inside the line cord. Do not remove ground prong off plug end.

PARTS LIST

- 1 - Control Panel Overlay
 - 1 - FCC Label
 - 6 - I.D. Tags
 - 1 - Manual
 - 12 - Buttons
- 1 - 3rd Player Cables
- 1 - Marquee Art
- 1 - Undercover Cops PCB

IREM AMERICA CORPORATION®

8434 154th Avenue NE
Redmond, WA 98052
(206) 881-0900
FAX (206) 881-6503

FOR SERVICE CONTACT:

Your authorized Irem America Corporation® Distributor
or

SUMMIT SERVICE
2274 University Avenue
St. Paul, MN 55114
(612) 645-9077

WARRANTY REPAIRS

Irem America Corporation PCB have a 90 day warranty from date of shipment. This includes all failures except those caused by the installer such as miswiring.

All PCB must be returned by an authorized Irem America Corporation distributor. A Return Material Authorization must be obtained from Summit Service prior to returning material. A Purchase Order must also be given to Summit Service at this time. The package must be clearly marked with the RMA number.

UNDERCOVER COPS® is protected by federal copyright laws and is the property of Irem America Corporation®. Any unauthorized versions of this game are illegal by federal law. AAMA protected stickers must be attached to the PCB. Please notify Irem America Corporation of any boards not having the AAMA seal.

IMPORTANT F.C.C. WARNING

THIS EQUIPMENT COMPLIES WITH THE REQUIREMENTS IN PART 15 OF FCC RULES FOR A CLASS A COMPUTING DEVICE. OPERATION OF THIS EQUIPMENT IN A RESIDENTIAL AREA MAY CAUSE UNACCEPTABLE INTERFERENCE OF RADIO AND TV RECEPTION REQUIRING THE OPERATOR TO TAKE WHATEVER STEPS ARE NECESSARY TO CORRECT THE INTERFERENCE. YOUR FCC COMPLIANCE LABEL IS ENCLOSED IN YOUR KIT AND MUST BE ATTACHED TO YOUR GAME PRIOR TO PLACING ON LOCATION. THIS LABEL INDICATES YOUR GAME WAS DESIGNED TO MEET FCC STANDARDS 47CFR15.19. WE ADVISE USING STAPLES IF NECESSARY TO MAKE SURE THE LABEL STAYS ON.

DANGER

The isolation transformer must be used with the monitor and power supply.

This game must be equipped with a three wire 110 volt plug for safety. Under no circumstance remove the ground plug.

DANGER

This game is designed with a JAMMA 56 pin connector. This plug is one of the finest operator friendly features in our industry today. What this means to you is that:

- 1) 1, 2, A, B, 27, 28, e and f are grounded
- 2) 3, 4, C and D are +5 volts
- 3) 5 and E are -5 volts
- 4) 6 and F are +12 volts

Also, all video and joystick functions are always in the same place. Once a cabinet is wired for JAMMA, it is easily changed from game to game.

Many older games such as Pac Man®, etc., have the power supply on the board. This will not work!!! Only a JAMMA connector with proper voltage will work. Irem America Corporation® recommends using an 11 or 15 amp switching power supply with **Undercover Cops®**.

MONITORS

Undercover Cops® is designed to be operated with a horizontal raster scan monitor with negative sync (RGB). This means **Undercover Cops®** will not work with any X-Y (Tempest, Space Dual, Star Trec), etc. An isolation transformer must be used in conjunction with the monitor. This is for your safety. The monitor also utilizes extremely high voltages. The monitor may also retain a charge for an extended period of time. Safety goggles must be worn while removing or replacing the monitor.

It is highly recommended that the monitor is verified good before the new **Undercover Cops®** kit is installed in your new and or rebuilt cabinet.

INSTALLATION OF KIT IN USED CABINET

To Disassemble:

1. Open back door and remove old board set and power supply, if you are using a new switching power supply.
2. Remove marquee glass and monitor glass.
3. Remove control panel and set aside.
4. Remove old wire harness, leaving 110 volt wiring intact. Also, leave the grounding straps to the monitor, coin door, control panel, and power supply intact.

Installation:

1. Mount the board set on the side panel of the cabinet as close to the middle of the game as possible (approximately 10-12" off bottom).

NOTE: Do not mount board directly below control or any vents or cracks so that liquids may seep on to the board. Do not forget about coins that may drop on to the board. Also, mount the board with edge connector facing up.

2. Mount the power supply on the bottom of the cabinet with connectors facing the rear of the cabinet. An optional mounting might be on the side panel just below the board set, connector to rear.
3. If the game does not have an isolation transformer, you must protect your customers and your game. Install one between the 110 volt line and your monitor/power supply.
4. Place the provided JAMMA wiring harness on the board. Connect the +5, +12, -5, and ground wires to the corresponding lugs on the power supply, connecting all the wires. If you don't, you will probably burn the board connector.
5. Run a wire from +12 volts to the coin door lights. Run a wire from +12 volts to the coin counters. This completes the power requirements.
6. Connect the Audio (+) and Audio (-) to the speaker.
7. Connect the video red, green, blue, ground, and sync to the corresponding wires on the monitor. If the monitor is not a negative composite sync, see sync modifications chart.
8. Cut the marquee to size. Replace the marquee lamp, if needed. Install the marquee panel.
9. Connect the coin 1 and coin 2 wires to the coin switches. Connect the coin counter 1 and coin counter 2 wires to the coin counters.

NOTE: If you only have one coin counter, see coin counter diagram. It will not matter if the coin counters are only rated at 6 volts, as the pulse is not long enough to burn out the counter.

- Disassemble the control panel of all the hardware. Do not remove the old panel overlay. Determine where to place the new joystick and buttons if they must be repositioned. Then, cut new holes.

NOTE: If you are going to use plexiglass over the control panel, we suggest that you use a good 1/8" polycarbonate with a scratch resistant coating. We recommend GENERAL ELECTRIC LEXAN MR5 with margard or TUFFAK CM-2. These do not crack or break with abuse.

Cut and drill plex as needed. Remove the old control panel overlay carefully and apply the new overlay on top of the old glue. Use an **Exacto** knife to cut out any button or bolt holes. Apply necessary decals over appropriate buttons. Now assemble the control panel.

- Bolt the control panel to the cabinet. Now connect the appropriate wires to the correct switches. Connect the 1 player and 2 player start wires.
- Be sure to install the FCC cage to avoid unnecessary radio frequency interference.
- Power up the game. Look over your installation for errors, and then apply power, listening for unusual sounds. Check for smoke or sparks. If everything is okay, wire tie all wires to form a nice, neat wiring harness. Clean the cabinet inside and out. Measure the +5 volts on the furthest point from the edge connector and adjust 5 volts to 5.05 volts. Use a tinted plex over the monitor if there are burns in the screen. We suggest bronze or grey tinted plex. Touch up the cabinet with fresh paint, and then repair all cabinet dents or chips, using an auto body product called **Duraglass**. This is similar to bondo. You can consult your local auto body shop or auto parts supplier for this product, as well as advice on how to use it.
- Be sure your ground plug is good. All metal exposed to the player must be grounded (coin door, control panel, etc.) including all metal inside exposed.

UNDERCOVER COPS®

Irem America Corporation recommends installing your new **UNDERCOVER COPS** kit in only a new or refurbished cabinet. Installing **UNDERCOVER COPS** in an older cabinet will result in lower earnings. The cabinet should be as follows:

- horizontal monitor
- 11 amp or larger power supply
- monitor not laying down flat.

CABINET TYPE

- START BUTTON
- ATTACK BUTTON

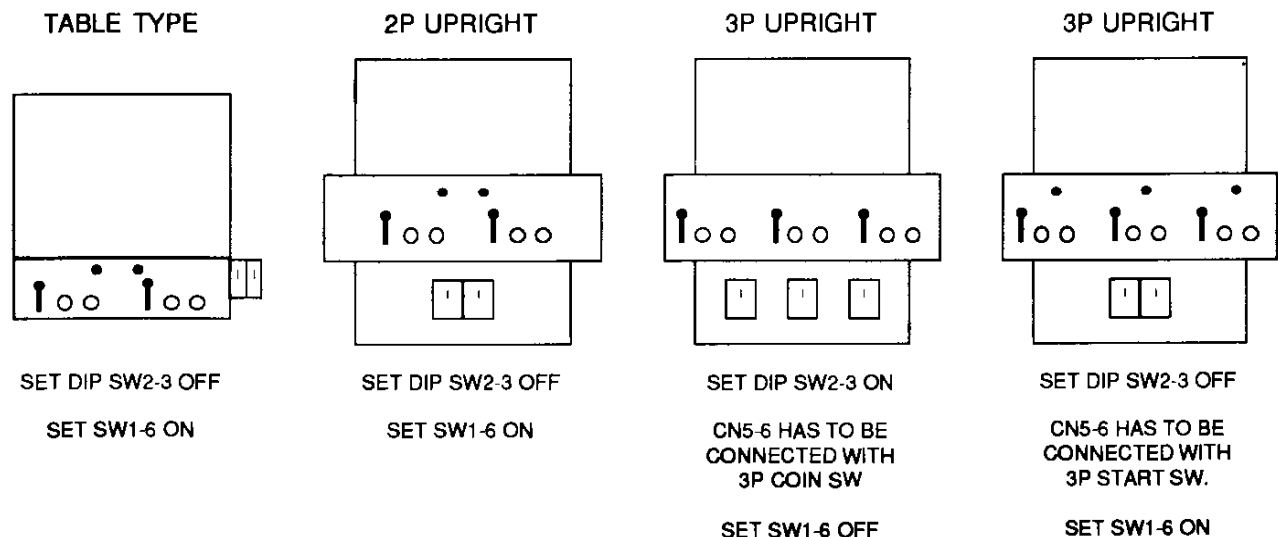

SPRING ACTION JOYSTICK

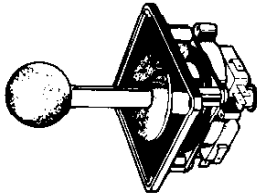

- Featuring:**
- Nylon and solid steel construction
 - Spring return to center
 - Micro or leaf switches individually replaceable
 - Long shaft, 1.5 inch diameter red knob fitted as standard

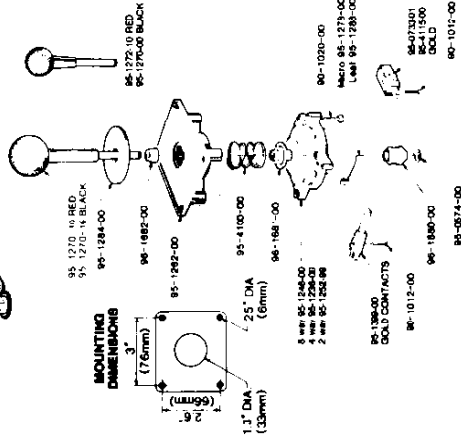

- PARTS LIST:**
- 95-1020-00 Switch Bracket Screw
 - 95-1012-00 M3 screw
 - 95-0874-00 E Ring
 - 95-0733-01 Microswitch
 - 95-1246-00 4-way bracket
 - 95-1238-00 4-way bracket
 - 95-1262-00 4-way bracket
 - 95-1270-00 Hub 1.25" knob & shaft
 - 95-1272-10 Red 1.25" knob & shaft
 - 95-1270-10 Red 1.5" knob & shaft
 - 95-1270-16 Black 1.5" knob & shaft
 - 95-1278-00 Microswitch protector
 - 95-1288-00 Leaf switch protector
 - 95-1284-00 2" Dia. washer
 - 95-1399-00 Self switch side mount
 - 95-4100-00 Self switch
 - 95-1890-00 Actuator microswitch
 - 95-1862-00 Z-Stop
 - 95-1861-00 Pivot cone

SPRING ACTION JOYSTICK	Price per ea.	1-24	25+
50-5508-02 8-way microswitch joystick 1.25" knob	12.95	9.95	9.95
50-5504-02 4-way microswitch joystick 1.25" knob	12.95	9.95	9.95
50-4308-02 4-way leaf switch joystick 1.25" knob	12.95	9.95	9.95
50-4304-02 4-way leaf switch joystick 1.25" knob	12.95	9.95	9.95
50-5508-02 8-way microswitch joystick 1.5" knob	12.95	9.95	9.95
50-5504-02 4-way microswitch joystick 1.5" knob	12.95	9.95	9.95
50-4508-02 4-way leaf switch joystick 1.5" knob	12.95	9.95	9.95
50-4504-02 4-way leaf switch joystick 1.5" knob	12.95	9.95	9.95

HAPP CONTROLS, INC.
106 Carlisch
Elk Grove, Illinois 60007
Phone: (312) 593-6130
Fax: (312) 593-6137
Telex: 297249 CONTROLS UR

SUPER JOYSTICK

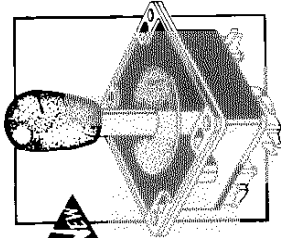

- Featuring:**
- Nylon and solid steel construction
 - Micro or leaf switches individually replaceable
 - Unique handle design
 - Spring return to center
 - Rugged actuator for long life
 - Change actuation to 4-way or 8-way simply by flipping actuator over

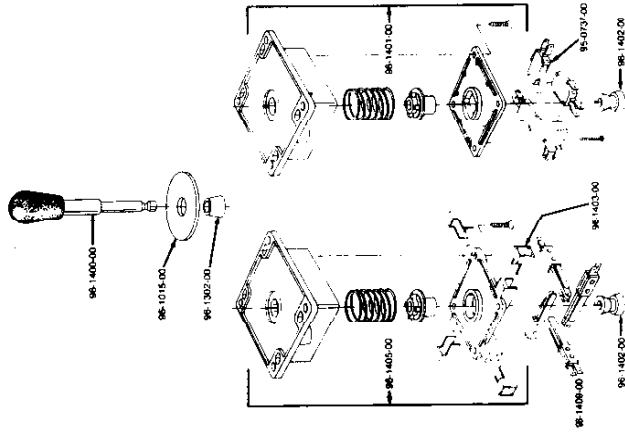

- PARTS LIST:**
- 95-1400-00 Chrome shaft & knob
 - 95-1015-00 Washer
 - 95-1302-00 Pivot cone
 - 95-1403-00 Black holder
 - 95-1405-00 Hub for leaf switch joystick
 - 95-1401-00 Hub for microswitch joystick
 - 95-1409-00 Leafswitch
 - 95-0737-00 Microswitch
 - 95-1402-00 4-way 8-way actuator joystick
- SUPER JOYSTICK Price per ea.**
- | | | |
|---|-------|-------|
| 50-6084-00 Super joystick 4-way 8-way microswitch | 15.95 | 13.95 |
| 50-6085-00 Super joystick 4-way 8-way leafswitch | 15.95 | 13.95 |

HAPP CONTROLS, INC.
106 Carlisch
Elk Grove, Illinois 60007
Phone: (312) 593-6130
Fax: (312) 593-6137
Telex: 297249 CONTROLS UR

1. Monitor Sync

If your monitor does not have dual polarity positions for sync, you may use one of the following methods to get your game going.

CURE 1: Install a simple one I.C. Circuit on your logic board. This I.C. may be "piggy backed" on to another 7404 series chip for power by bending up all but the two power pins so that they are parallel to the top surface of the new I.C. and then connecting the power pins only to the existing chip. (See Fig. 1) Next connect the sync wires as shown in Fig. 2. (Note: Figure 2 shows a hookup for either **composite** or **separate** syncs.)

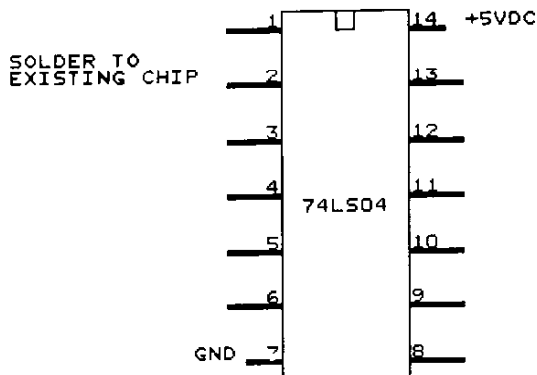

FIG. 1

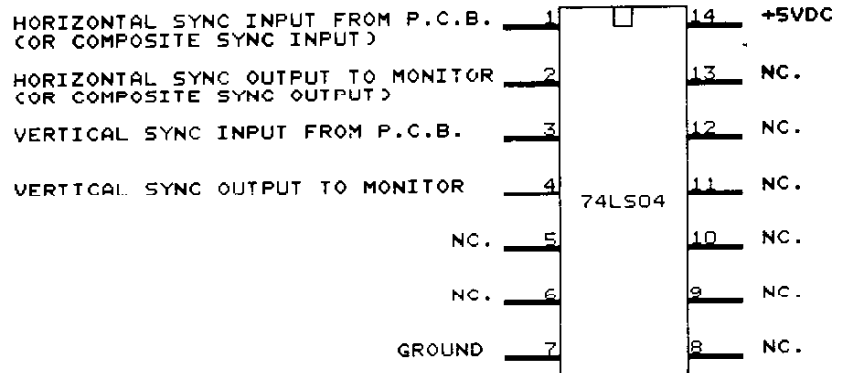
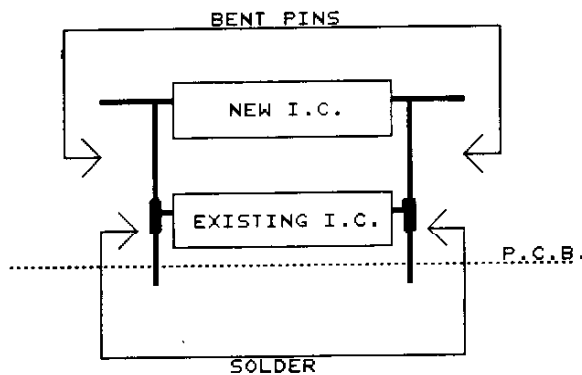

FIG. 2



CURE 2: Used for Wells-Gardner Video-Sync boards with positive sync connections only. (Vertical mount board 85x14 OB.)

Cut the traces on the solder side of the board between input pins 5 & 6 to the unbanded (anode) ends of diodes X201 & X202.

Add MPSA 56 transistor as follows:

Collector to anode leads of diodes X201 & X202. Base pins 5 & 6 of the video input connector. Emitter to cathode (banded) lead of zener diode ZD201.

Insert a 1N4148 diode - cathode to the emitter of the MPSA56 and anode to the base. (See Fig. 3)

FIG. 3

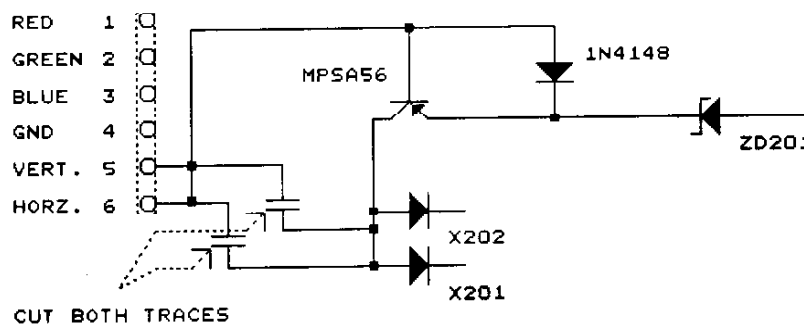

2. Horizontal Tearing

CAUSE: The negative sync signal of most logic sets are slightly different than the GO7-CBO monitor negative sync inputs. The result of this mismatch is a horizontal "wave" or "curl".

CURE 1: On the monitor deflection board, replace C303 with a 10uf 25V radial lead capacitor with the positive lead towards the collector of X305. (*CAUTION: be sure to check this step as the original cap is not polarized.*) Then replace C501 with the cap removed from the C303 location.

CURE 2: Connect 1N4148 fast-switching diodes across both the positive and negative sync inputs to the monitor. (*See Fig. 4*) **NOTE:** Both diodes must be installed or you will not have vertical stability.

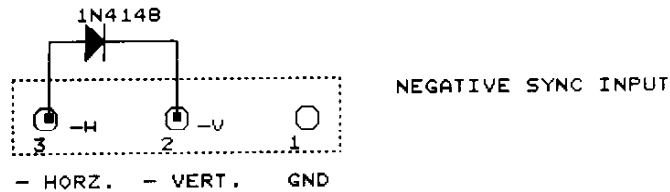
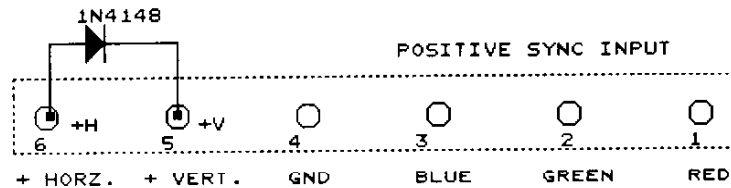

FIG. 4



CURE 3: Join negative sync inputs J2 and J3 together with a jumper. Locate W102 and install a jumper from W102 to either J2 or J3.

CURE 4: For Wells-Gardner K4600 series monitors.

Replace C356 (4 7uf 25V) on the Horizontal/vertical board (*vertically mounted board nearest the flyback transformer*) and center the horizontal hold pot. Turn L351 for the best horizontal stability and fine-tune with the horizontal width pot.

COIN COUNTER DIAGRAM

If only one coin counter is to be used install two diodes in the following manner:

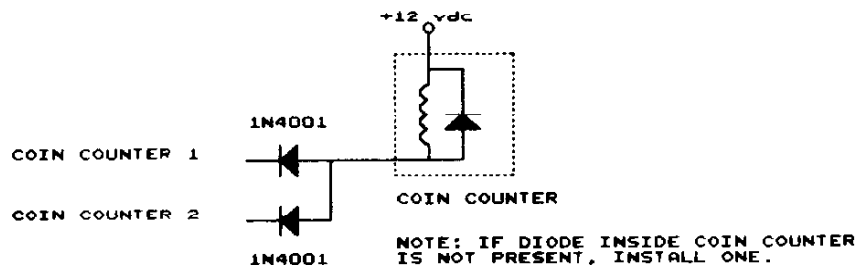

UNDERCOVER COPS

DIP SWITCH SETTINGS

DIP SWITCH 1									
FUNCTION	SWITCH NUMBER								
		1	2	3	4	5	6	7	8
NUMBER OF WARRIORS	2	OFF	OFF						
	3	ON	OFF						
	4	OFF	ON						
	1	ON	ON						
DIFFICULTY	NORMAL			OFF	OFF				
	EASY			ON	OFF				
	HARD			OFF	ON				
				ON	ON				
START BUTTONS	YES						OFF		
	NO						ON		
ATTRACT MODE	NO							OFF	
	YES							ON	
DIAGNOSTIC TEST MODE	NORMAL								OFF
	TEST								ON

START BUTTONS: THIS FEATURE IS USED IN CONJUNCTION WITH DIP SWITCH 2-3, TO ALLOW THE ATTACK BUTTONS TO START THE GAME PLAY. THIS ALLOWS THE USE OF INDIVIDUAL COIN CHUTES ON THREE PLAYER PANELS.

TEST MODE: TURN SWITCH #8 ON, DEPRESS BOTH ATTACK & JUMP BUTTONS AT THE SAME TIME. EXIT THE TEST MODE BY DEPRESSING BOTH THE ATTACK & JUMP BUTTONS TOGETHER A SECOND TIME.

DIP SWITCH SETTINGS

DIP SWITCH 2									
FUNCTION	SWITCH NUMBER								
		1	2	3	4	5	6	7	8
INVERT SCREEN	NORMAL	OFF							
	INVERT	ON							
NUMBER OF PLAYERS	2		OFF						
	3		ON						
COIN CHUTES	COMMON			OFF					
	INDEPENDENT			ON					
COIN MODE 1	1 COIN / 1 PLAY				OFF	OFF	OFF	OFF	OFF
	2 COIN / 1 PLAY				OFF	ON	OFF	OFF	OFF
	3 COIN / 1 PLAY				OFF	OFF	ON	OFF	OFF
	4 COIN / 1 PLAY				OFF	ON	ON	OFF	OFF
	5 COIN / 1 PLAY				OFF	OFF	OFF	ON	OFF
	6 COIN / 1 PLAY				OFF	ON	OFF	ON	OFF
	1 COIN / 2 PLAY				OFF	OFF	ON	ON	OFF
	1 COIN / 3 PLAY				OFF	ON	ON	ON	OFF
	1 COIN / 4 PLAY				OFF	OFF	OFF	OFF	ON
	1 COIN / 5 PLAY				OFF	ON	OFF	OFF	ON
	1 COIN / 6 PLAY				OFF	OFF	ON	OFF	ON
	2 COIN / 3 PLAY				OFF	ON	ON	OFF	ON
	3 COIN / 2 PLAY				OFF	OFF	OFF	ON	ON
	4 COIN / 3 PLAY				OFF	ON	OFF	ON	ON
CONTINUE COIN					OFF	OFF	ON	ON	ON
	FREE PLAY				OFF	ON	ON	ON	ON
COIN MODE 2A	1 COIN / 1 PLAY				ON	OFF	OFF		
	2 COIN / 1 PLAY				ON	ON	OFF		
	3 COIN / 1 PLAY				ON	OFF	ON		
	5 COIN / 1 PLAY				ON	ON	ON		
COIN MODE 2B	1 COIN / 2 PLAY				ON			OFF	OFF
	1 COIN / 3 PLAY				ON			ON	OFF
	1 COIN / 5 PLAY				ON			OFF	ON
	1 COIN / 6 PLAY				ON			ON	ON

CONTINUE COIN: THIS MODE WILL USE TWO COINS TO START A GAME AND ONE COIN TO CONTINUE. IF TWO PLAYERS ARE GOING TO PLAY FOUR COINS ARE REQUIRED TO START AND 2 COINS TO CONTINUE. THIS MODE MAY NOT BE SELECTED WITH ANY OTHER COIN MODE.

UNDERCOVER COPS

JAMMA CONNECTOR

COMPONENT SIDE FUNCTION	POS	POS	SOLDER SIDE FUNCTION
GROUND	1	A	GROUND
GROUND	2	B	GROUND
+5 VOLTS	3	C	+5 VOLTS
+5 VOLTS	4	D	+5 VOLTS
-5 VOLTS	5	E	-5 VOLTS
+12 VOLTS	6	F	+12 VOLTS
PREVENT KEY	7	H	PREVENT KEY
COIN COUNTER #1	8	J	COIN COUNTER #2
GROUND	9	K	GROUND
AUDIO POS +	10	L	AUDIO NEG -
	11	M	
VIDEO RED	12	N	VIDEO GREEN
VIDEO BLUE	13	P	VIDEO SYNC*
VIDEO GROUND	14	R	SERVICE SWITCH
TEST SWITCH	15	S	
COIN INPUT 1	16	T	COIN INPUT 2
START 1	17	U	START 2
1P UP	18	V	2P UP
1P DOWN	19	W	2P DOWN
1P LEFT	20	X	2P LEFT
1P RIGHT	21	Y	2P RIGHT
1P ATTACK	22	Z	2P ATTACK
1P JUMP	23	a	2P JUMP
	24	b	
	25	c	
	26	d	
GROUND	27	e	GROUND
GROUND	28	f	GROUND

3RD PLAYER CONNECTIONS

CN5

POS	FUNCTION
1	GROUND
2	3P RIGHT
3	3P LEFT
4	3P DOWN
5	3P UP
6	3P START/COIN
7	
8	3P JUMP
9	3P ATTACK

WHEN DIP SWITCH 2-3 IS OFF, CN5-6 HAS TO BE CONNECTED TO THE 3P START SWITCH. WHEN DIP SWITCH 2-3 IS ON, CN5-6 HAS TO BE CONNECTED TO THE 3P COIN SWITCH.

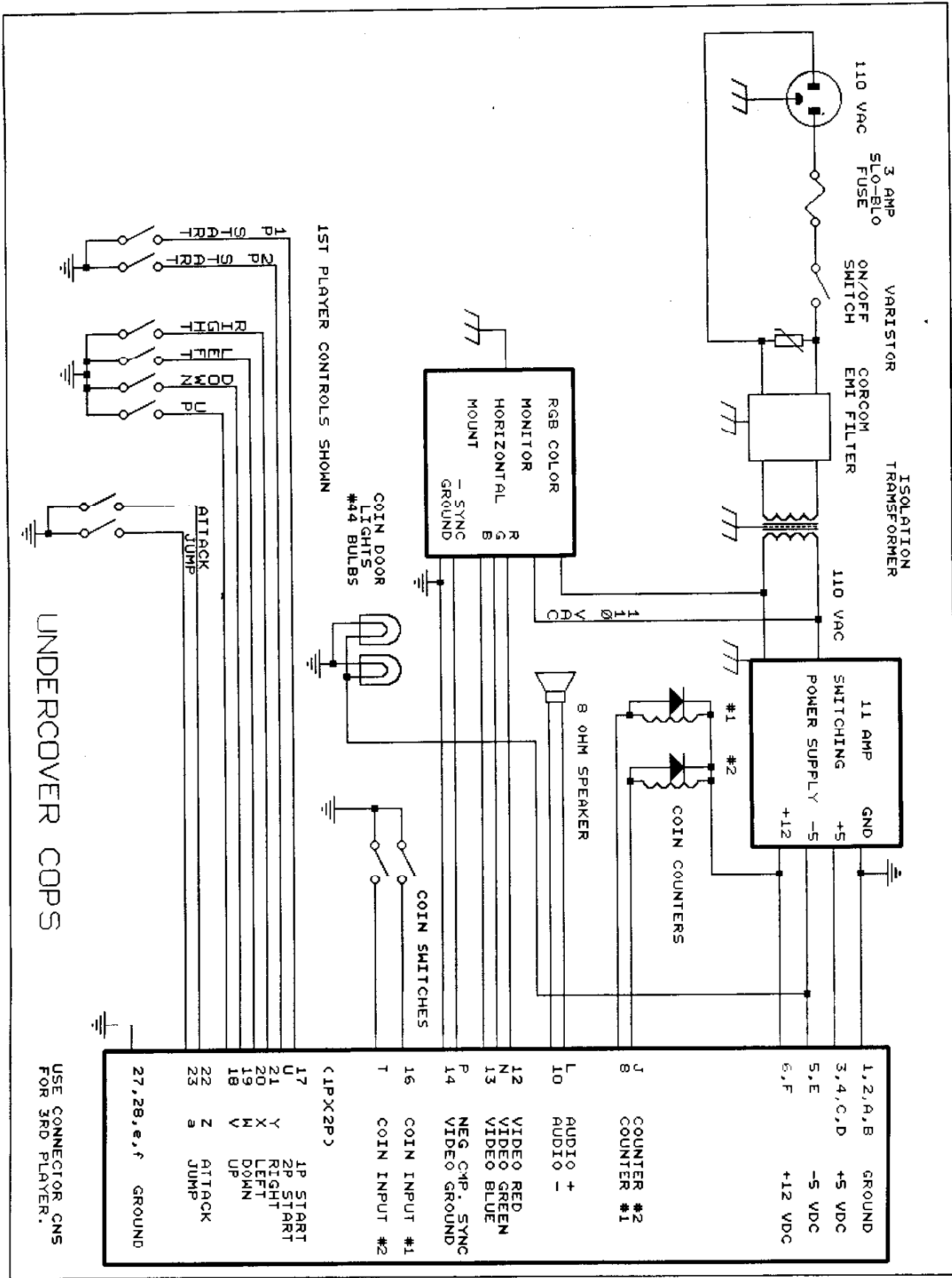

UNDERCOVER COPS

USE CONNECTOR CNS FOR 3RD PLAYER.

1, 2, A, B	GROUND
3, 4, C, D	+5 VDC
5, E	-5 VDC
6, F	+12 VDC
J	COUNTER #2
8	COUNTER #1
L	AUDIO +
10	AUDIO -
12	VIDEO RED
N	VIDEO GREEN
13	VIDEO BLUE
P	NEG. CMP. SYNC
14	VIDEO GROUND
16	COIN INPUT #1
T	COIN INPUT #2
(1P X 2P)	
17	1P START
U	2P START
21	RIGHT
20	LEFT
19	DOWN
18	UP
22	Z
23	ATTACK JUMP
27, 28, e, f	GROUND

