



OPERATING MANUAL for:

DEDICATED CABINET,

CONVERSION KIT

&

CHIP UPDATE KIT

(From Wing Shooting Championship to Trophy Hunting)

 **Sammy USA Corporation**

901 Cambridge Drive
Elk Grove Village, IL 60007
Phone: (847) 364-9787
Fax: (847) 364-9831
Web: www.sammyusa.com
Toll free: 1-888-US-SAMMY

© 2002 Sammy USA Corporation

CONTENTS

<u>PLEASE READ BEFORE INSTALLING...</u>	Page 1
<u>1. SPECIFICATIONS (DEDICATED CABINET)</u>	Page 2
<u>2. CHIP UPDATE KIT PACKAGE CONTENTS</u>	Page 3
<u>3. KIT PACKAGE CONTENTS</u>	Page 4
<u>4. GAME PLAY</u>	Page 5
<u>5. HANDLING AND INSTALLATION</u>	Page 6
<u>6. CONNECTOR TABLE</u>	Page 7
<u>7. DIP SWITCH TABLE</u>	Page 8
<u>8. CHIP UPDATE LOCATION AND INSTALLATION</u>	Page 9, 10
<u>9. KIT INSTALLATION</u>	Page 11, 12
<u>10. TEST MODE</u>	Page 13, 14, 15
<u>11. TROUBLE WITH GUN SHOOTING</u>	Page 16
<u>12. WARRANTY</u>	Page 17
<u>13. ELECTRICAL WIRING DIAGRAM (DEDICATED CABINET)</u>	Page 18

PLEASE READ BEFORE INSTALLING THE TROPHY HUNTING KIT

The TROPHY HUNTING KIT is designed only for a Normal resolution monitor. The High or Medium resolution monitor will not work for TROPHY HUNTING KIT.

MIS-CONNECTING THE GUN CONNECTOR

When you connect the Gun unit to Main PCB, you must always make sure to connect to the correct connectors which are CN 5 & CN 6 and CN 7 & CN 8 connectors.

If you connect Gun unit to CN 2, 8 pin connector, your PCB will sustain serious damage.

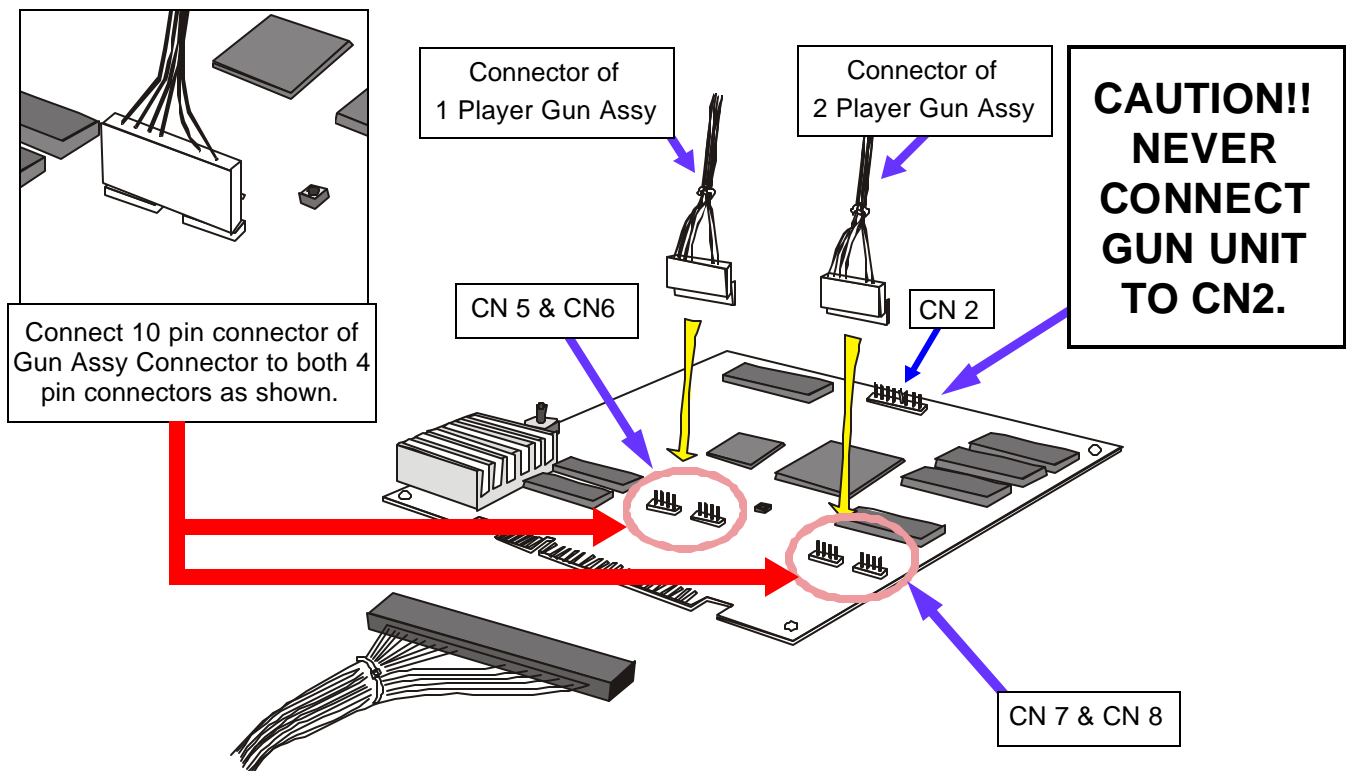



1. SPECIFICATIONS (DEDICATED CABINET)

POWER 120VAC @ 60Hz USA & CANADA / 230VAC @ 50Hz EUROPE

DIMENSIONS Width: 26.5" (673 mm)
Height: 73.5" (1867 mm)
Depth: 33" (838 mm) with Gun Assy = 40" (1016 mm)

WEIGHT: 311 lbs (142 kg)

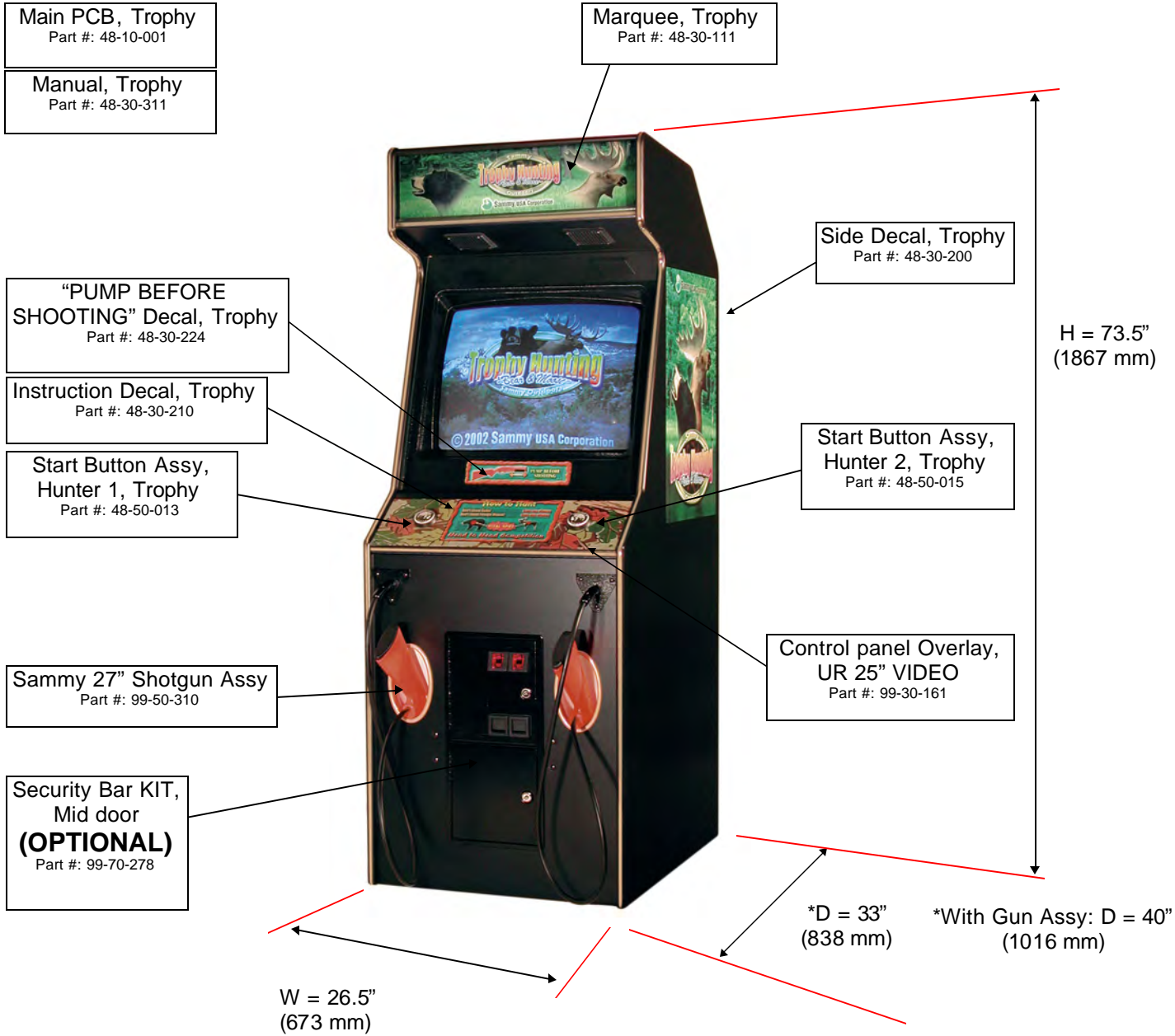



CHIP UPDATE KIT

2. CHIP UPDATE KIT PACKAGE CONTENTS

A MASK ROM set (5 PCS/SET)

Part#: 48-90-800

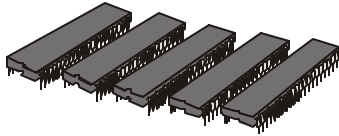

B START button Assy, Hunter 1

Part#: 48-50-013



C START button Assy, Hunter 2

Part#: 48-50-015



D Instruction Decal Sheet

Part#: 48-30-210



E "Pump Before shooting" Decal

Part#: 48-30-224

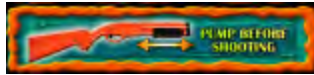

F Program EP-ROM set (2 PCS/SET)

Part#: 48-90-000

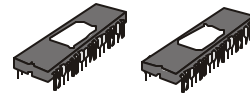

G Marquee Styrene

Part#: 48-30-100



H Side Decal (2 sheet)

Part#: 48-30-200



I Conversion Kit Instructions

Part#: 48-30-301



J AAMA Sticker

Part#: 99-30-750



3. KIT PACKAGE CONTENTS



A Main P.C.Board
Trophy Hunting
48-10-001

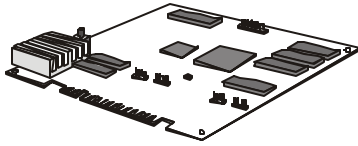

B START button
Assy, Hunter 1
48-50-013



C START button
Assy, Hunter 2
48-50-015



D Instruction Decal Sheet
48-30-210



E "PUMP BEFORE SHOOTING"
Decal
48-30-224



F Marquee Styrene
48-30-100



G Control Overlay
99-30-150



H Side Decal (2 sheets)
48-30-200



I Gun Holster (2 sets)
99-50-303



J Conversion Kit
Instructions
48-30-300

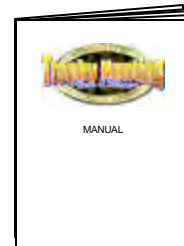

K AAMA Sticker
99-30-750

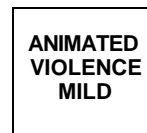

L Gun Assy (2 guns)
99-50-310

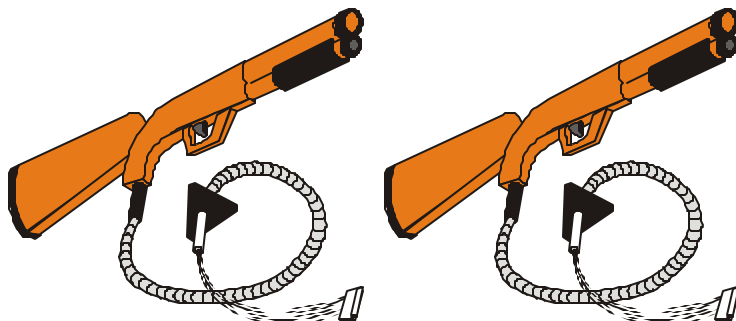



4. GAME PLAY

Trophy Hunting is a sports hunting game that has an exciting COMPETITION MODE. Two players can play at the same time in competition mode which is a Sammy USA "EXCLUSIVE"!

HOW TO PLAY

- ? Insert coin(s) and press Hunter 1 or Hunter 2 button to start game.
- ? Use Sammy 27" Shotgun to (Pump the Shotgun before you shoot the screen each time.) Select one of 6 states. Colorado, Idaho or Maine for Bear and 3 states Montana, Utah or Alaska for Moose.
- ? Use Sammy 27" Shotgun to select weapon. There are 4 kinds of weapons.
 - Bolt-Action Rifle (Ammo x 4), Compound Bow (Ammo x 8)**
 - Revolver with scope (Ammo x 6), Muzzleloader (Ammo x 1)**
- ? 12 areas per state with one bonus stage after the 6th area. The Bonus stage is TARGET SHOOTING.





5. HANDLING AND INSTALLATION

PLEASE TAKE A MOMENT TO READ THE FOLLOWING BEFORE YOU TURN ON YOUR NEW GAME.

The **Trophy Hunting** video game is an indoor game machine. It is not designed for outdoor use. Avoid installing the game in the following locations:

- ◆ Locations subject to rain or water damage
- ◆ Locations in direct sunlight
- ◆ Locations subject to extreme heat
- ◆ Locations near hazardous or flammable liquids or chemicals

You will need the following minimum dimensions for egress into your location:

- ◆ 80 inches in height
- ◆ 30 inches in width

INSTALLATION

Unpack your game carefully. Be careful of the shipping staples. They can be sharp.

Your game is assembled and should not need any assembly.

Level your game using enclosed Leg levelers.

The standard voltage for U.S. and Canada 120V / 125V - 3A; Europe 220V / 240V - 2A.

Use of extension cords is prohibited.

Use only a grounded outlet. **YOUR GAME MUST BE GROUNDED!!!**

The minimum space required for operation in your location should be:

- ◆ 80" high
- ◆ 30" wide
- ◆ 75" depth

THE GAME MUST BE LEVEL. USE A LEVEL TO AVOID NEEDLESS ADJUSTMENTS.

SAFETY PRECAUTIONS

- ◆ Be sure to turn the power off or unplug the game before working on the unit.
- ◆ Do not unplug game by pulling on the line cord.
- ◆ Replace line cord if the insulation is damaged in any way with one of equal quality.
- ◆ Replace open fuses with same type and rating.
- ◆ Re-check and re-seat all harness connections.

6. CONNECTOR TABLES



JAMMA CONNECTOR					
MAIN P.C.BOARD					
SOLDER SIDE			COMPONENT SIDE		
FUNCTION	COLOR	PIN #	PIN #	COLOR	FUNCTION
GROUND	BLK	A	1	BLK	GROUND
GROUND	BLK	B	2	BLK	GROUND
+5VDC	RED	C	3	RED	+5VDC
+5VDC	RED	D	4	RED	+5VDC
		E	5		
+12VDC	BLU	F	6	BLU	+12VDC
KEY		H	7		KEY
COIN METER B		J	8		COIN METER A
COIN LOCKOUT B		K	9		COIN LOCKOUT A
SPEAKER(-)	BLK	L	10	WHT/BLK	SPEAKER(+)
		M	11		
VIDEO GREEN	GRN	N	12	RED	VIDEO RED
VIDEO SYNC	WHT	P	13	BLU	VIDEO BLUE
SERVICE CREDIT SWITCH	BRN/WHT	R	14	BLK	VIDEO GROUND
		S	15	WHT/GRY	TEST SWITCH
COIN SWITCH B		T	16		COIN SWITCH A
2P START BUTTON		U	17		1P START BUTTON
		V	18		
		W	19		
		X	20		
		Y	21		
		Z	22		
		a	23		
		b	24		
		c	25		
		d	26		
GROUND	BLK	e	27	BLK	GROUND
GROUND	BLK	f	28	BLK	GROUND

CN6 - 4 PIN SUB CONNECTOR		
MAIN P.C.BOARD (1P GUN)		
PIN #	COLOR	FUNCTION
1		
2	GREEN	PUMP SWITCH
3	BLACK	PUMP SWITCH GND
4		

CN8 - 4 PIN SUB CONNECTOR		
MAIN P.C.BOARD (2P GUN)		
PIN #	COLOR	FUNCTION
1		
2	GREEN	PUMP SWITCH
3	BLACK	PUMP SWITCH GND
4		

CN5 - 4 PIN SUB CONNECTOR		
MAIN P.C.BOARD (1P GUN)		
PIN #	COLOR	FUNCTION
7	RED	+5VDC
8	WHITE	TRIGGER SWITCH
9	BROWN	GROUND
10	BLUE	OPTICAL

CN7 - 4 PIN SUB CONNECTOR		
MAIN P.C.BOARD (2P GUN)		
PIN #	COLOR	FUNCTION
7	RED	+5VDC
8	WHITE	TRIGGER SWITCH
9	BROWN	GROUND
10	BLUE	OPTICAL

7. DIP SWITCH TABLES



DIP SWITCH 1		SWITCH POSITIONS							
FUNCTIONS	SETTING	1	2	3	4	5	6	7	8
COIN CHUTE A, B	1 COIN START, 1 COIN CONTINUE	OFF	OFF	OFF	OFF				
	2 COINS START, 2 COINS CONTINUE	ON	OFF	OFF	OFF				
	2 COINS START, 1 COIN CONTINUE	OFF	ON	OFF	OFF				
	3 COINS START, 3 COINS CONTINUE	ON	ON	OFF	OFF				
	3 COINS START, 2 COINS CONTINUE	OFF	OFF	ON	OFF				
	3 COINS START, 1 COIN CONTINUE	ON	OFF	ON	OFF				
	4 COINS START, 4 COINS CONTINUE	OFF	ON	ON	OFF				
	4 COINS START, 3 COINS CONTINUE	ON	ON	ON	OFF				
	4 COINS START, 2 COINS CONTINUE	OFF	OFF	OFF	ON				
	4 COINS START, 1 COIN CONTINUE	ON	OFF	OFF	ON				
	1 COIN 2 CREDITS, 1 CREDIT START & CONTINUE	OFF	ON	OFF	ON				
	1 COIN 3 CREDITS, 1 CREDIT START & CONTINUE	ON	ON	OFF	ON				
	1 COIN 4 CREDITS, 1 CREDIT START & CONTINUE	OFF	OFF	ON	ON				
	1 COIN 5 CREDITS, 1 CREDIT START & CONTINUE	ON	OFF	ON	ON				
	1 COIN 6 CREDITS, 1 CREDIT START & CONTINUE	OFF	ON	ON	ON				
	FREE PLAY	ON	ON	ON	ON				
NOT USED						OFF	OFF	OFF	
TEST MODE	OFF								OFF
	ON								ON

DIP SWITCH 2		SWITCH POSITIONS							
FUNCTIONS	SETTING	1	2	3	4	5	6	7	8
MONITOR SETTING 1	NORMAL	OFF							
	REVERSE VERTICAL	ON							
MONITOR SETTING 2	NORMAL		OFF						
	REVERSE HORIZONTAL		ON						
ATTRACT SOUND	ON			OFF					
	OFF			ON					
DIFFICULTY LEVEL	NORMAL				OFF	OFF			
	EASY				ON	OFF			
	HARD				OFF	ON			
	HARDEST				ON	ON			
BLOOD COLOR	RED						OFF		
	YELLOW						ON		
CHANCES	2							OFF	
	3							ON	
GUN TYPE	PUMP ACTION GUN UNIT								OFF
	HAND GUN UNIT								ON

"FACTORY INSTALLED" SETTING

8. CHIP UPDATE LOCATION AND INSTALLATION

1. Exchange the ROMS

There are 5 pcs of MASK-ROMS and 2 pcs of Program EP-ROMS on Wing Shooting Championship Main PCB. Remove the Wing Shooting Championship Main PCB from your cabinet. Refer to the position of all ROMS as shown below to exchange to the Trophy Hunting ROMS.

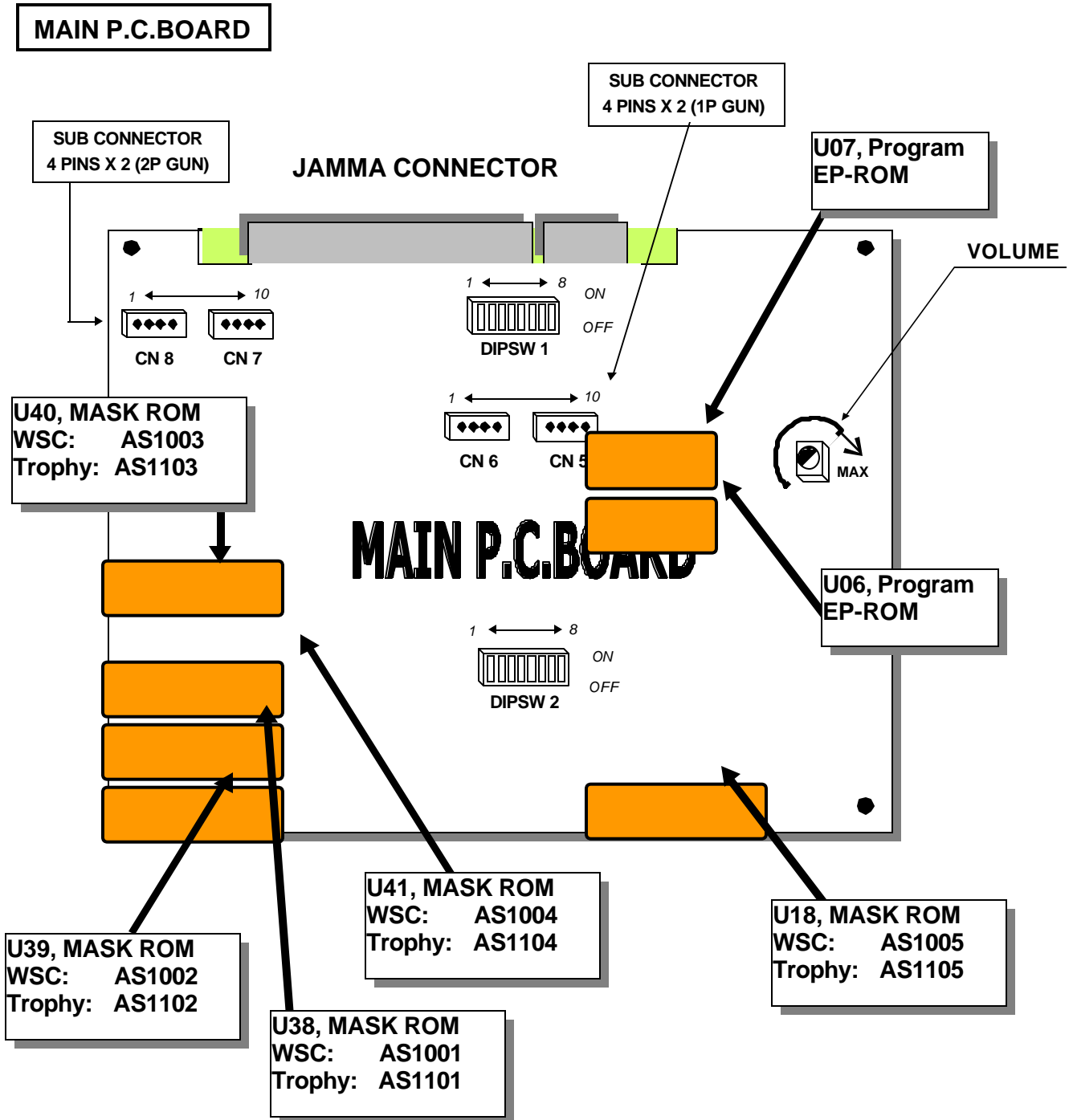

2. Change the GAME CABINET

- **MARQUEE STYRENE**

Change the Wing Shooting Championship Marquee to the TROPHY HUNTING Marquee.

NOTE: If the TROPHY HUNTING Marquee Styrene does not fit your cabinet, you should cut the marquee to fit.

- **HUNTER 1 AND HUNTER 2 BUTTONS**

Take off the Wing Shooting Championship Hunter 1 and Hunter 2 button assys from the control panel. Then put on the TROPHY HUNTING Hunter 1 and Hunter 2 button assys.

- **INSTRUCTION SHEET (HOW TO HUNT)**

Take off the Wing Shooting Championship INSTRUCTION SHEET (HOW TO HUNT) from the control panel. Then put on the TROPHY HUNTING INSTRUCTION SHEET (HOW TO HUNT).

- **SIDE DECALS**

Change the Wing Shooting Championship Side decals to the TROPHY HUNTING Side decals.

- **INSTRUCTION DECAL SHEET**

Put "PUMP BEFORE SHOOTING" Decal Sheet on the front glass of the monitor.

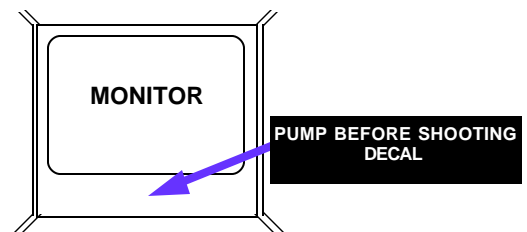

- **AAMA "ANIMATED VIOLENCE MILD" STICKER**

Place AAMA sticker on the upper left hand side corner of the marquee.

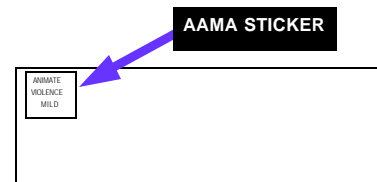



9. KIT INSTALLATION

1. Change the GAME CABINET

• MARQUEE STYRENE

Change the old marquee to the TROPHY HUNTING Marquee Styrene.

NOTE: If the TROPHY HUNTING Marquee Styrene does not fit your cabinet, you should cut the marquee to fit.

• CONTROL PANEL

Change the parts on the control panel. Take off the old parts (Joystick or Gun unit assy) and the old push button assys from the control panel. Then put on the TROPHY HUNTING Control Panel Overlay.

NOTE: After you put on the TROPHY HUNTING Control Panel Overlay, you must make the holes for the TROPHY HUNTING Gun Assy, Gun Holster and Push Button Assy. See sample layout below. Or if you want, install Gun Assy or Gun Holster on the side of Cabinet.

MOUNTING DIMENSIONS FOR PUSH BUTTON ASSY

MOUNTING DIMENSIONS FOR GUN ASSY

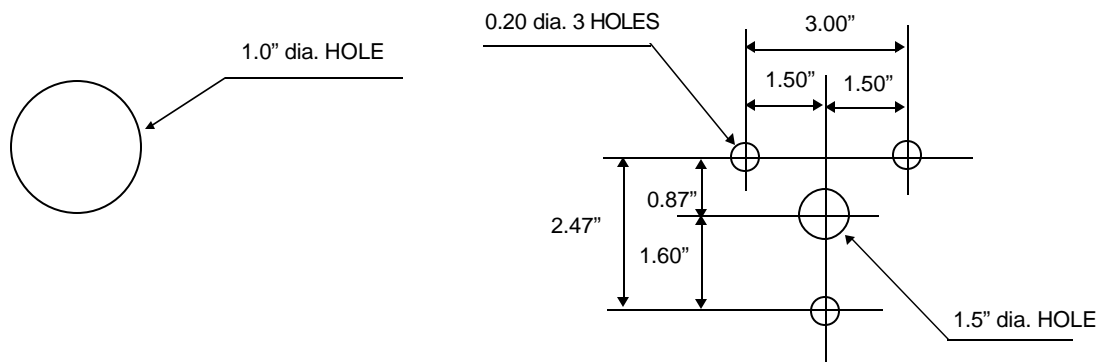

MOUNTING GUN HOLSTER

You can mount GUN HOLSTER to the top of the control panel or side of cabinet.

To mount it, use HOLSTER as a template for drilling holes. Use a hex wrench to tighten screws.

IF YOU WANT TO INSTALL A HAND GUN:

You can use a HAND GUN instead of the original pump action gun for this game.

WARNING

Be absolutely sure that the connector for the hand gun matches exactly the pin position for CN5 (1P Gun) and CN7 (2P Gun) as shown on page 4.

Connect 1P Gun connector to CN5, 2P Gun connector to CN7 and turn on Dip switch 2, #8. See page 5 for Dip switch table.

- **INSTRUCTION DECAL SHEET**
Put "PUMP BEFORE SHOOTING" Decal Sheet on the front glass of the monitor.

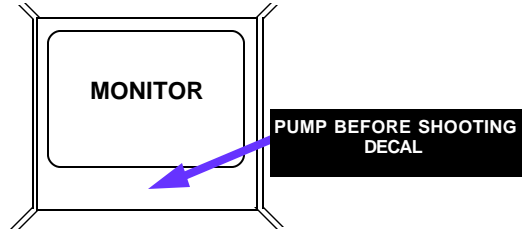

- **AAMA "ANIMATED VIOLENCE MILD" STICKER**
Place AAMA sticker on the upper left hand side corner of the marquee.

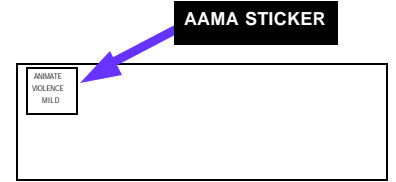

Remove old P. C .Boards and install new P. C. Board in its place.

2. Connect the HARNESSES

- **JAMMA HARNESS**
Connect the JAMMA Harness to the edge connector on the TROPHY HUNTING Main P.C.BOARD.
- **GUN HARNESS**
Connect the Gun Harness to the Gun Connectors located on the Main P.C. Board components side, at CN5 & 6 and CN7 & 8 connectors on the P.C. BOARD. Connect Gun Connector to CN5 & 6 and CN7 & 8, correctly, as shown below.

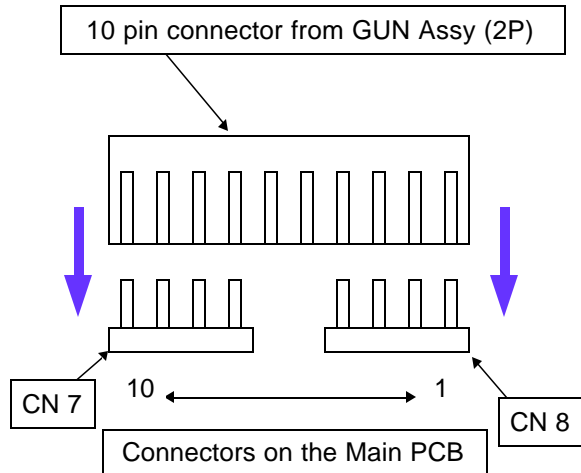
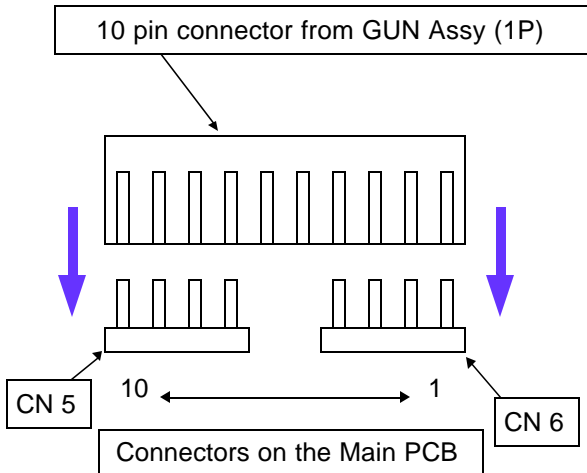



10. TEST MODE

Entering the TEST MODE

If you need to check the condition of the game circuitry and controls, you can use the TEST MENU. Turn ON "DIP SWITCH 1, #8" and re-power on the game. The game will go into TEST MODE (diagnostics) and the screen appears as follows:

Select TEST

Use this screen to choose which of the 7 screens you want to see. Move cursor using the START BUTTON. Then pull the TRIGGER to enter the function.

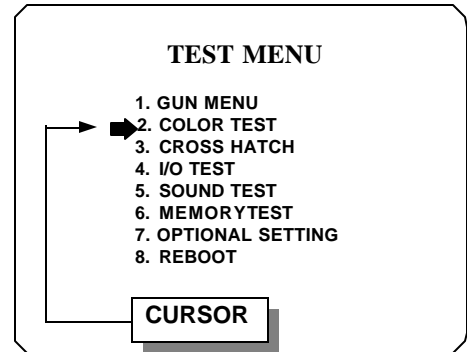

1. GUN MENU

You can adjust GUN unit in GUN ADJUST mode.

Gun Adjust

1. Enter TEST MENU and select GUN ADJUST.
2. Shoot center mark only with gun sight.
3. If you need more accuracy, try again.
4. Press START button to save Gun accuracy and enter GUN TEST mode, press START button again to go back to Main menu.

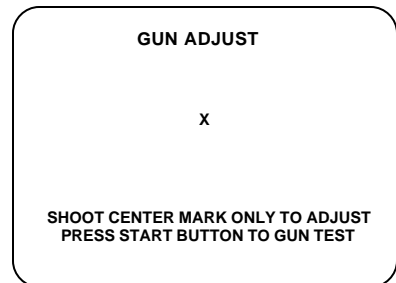

You can test accuracy in GUN TEST mode.

Gun Test

1. At Gun Adjust screen, press START button to go to test mode.
2. Shoot all around the screen to see Gun's accuracy.
3. Press START button to go back to Main menu.



2. COLOR TEST

Use this screen to check the color of monitor. The color blocks in the center should be four bands (Red, Green, Blue and White from top to bottom), each with a color scale from dark to bright, left to right. If the screen does not match this description, adjust the Monitor as described in the Monitor's manual.

* Press the START button to exit and go back to the TEST MENU screen.

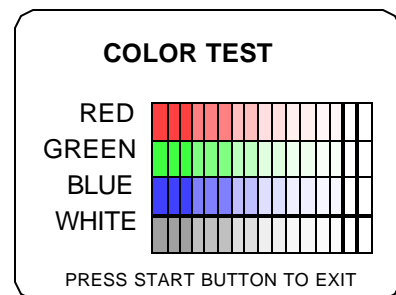

3. CROSS HATCH

Use this screen to check the size of picture. The CROSS HATCH test pattern has a White grid on a Black background. Check following:

- The grid line should be straight, and the lines should not have excessive pincushion or barrel distortion.
- "Out"line of grid line is the same size as "Out"line of game screen. So, "Out"line should be able to be seen with no overflow of grid lines on screen.

If these are not as above, adjust the Monitor as described in the Monitor's manual.

- * You can exit and go back to the TEST MENU screen by press START button.

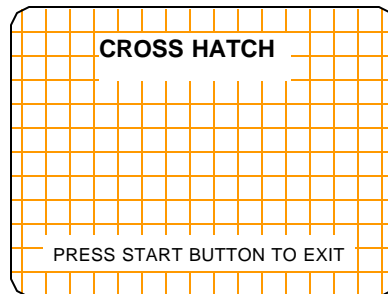

4. I/O TEST

Use this screen to check the switches in this game. To check the functioning of each switch, activate it and watch the corresponding OFF letters change to ON. If the ON and OFF letters do not appear correctly, check the Harness connections and Switches.

- * Press START button and Gun trigger simultaneously to exit.

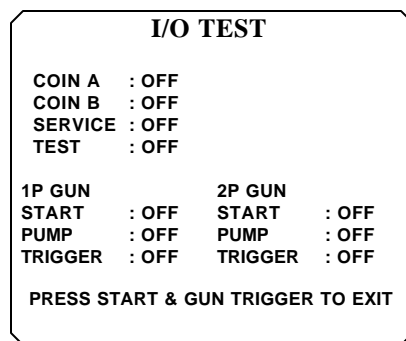

5. SOUND TEST

Use this screen to check all game sounds. Choose a sound with the START buttons. (Hunter 1 = forward, Hunter 2 = Back) Then pull the TRIGGER. You can check each sound in this game.

- * Press START button and Gun trigger simultaneously to exit.

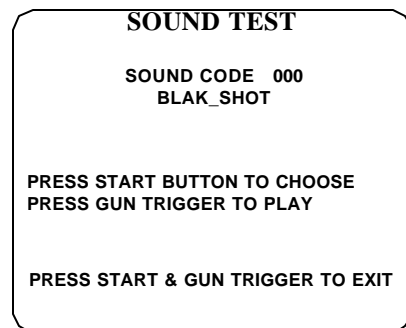

6. MEMORY TEST

Use this screen to check RAM and ROM on the Main P.C.B. The Main P.C.B. will automatically check them when you enter this screen. If there are no problems, the word **OK** will appear on screen. If you get the word **ERROR**, check the mounting of RAMs or ROMs on the Main P.C.B. and if **ERROR** reappears, it needs to be replaced.

- * This mode will automatically exit after testing is finished.

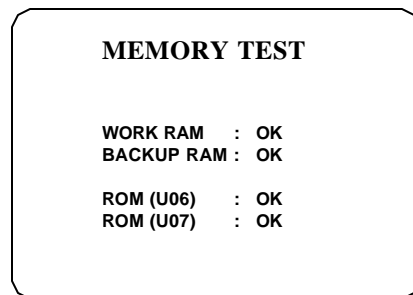

7. OPTIONAL SETTING

HIGH SCORE CLEAR

If you desire to clear HIGH SCORE data, do the following.

HOW TO SET UP

1. Enter TEST MENU and select OPTIONAL SETTING.
2. Press START BUTTON to choose HIGH SCORE CLEAR.
3. Select YES by pressing START BUTTON and pressing GUN TRIGGER to clear HIGH SCORE data.
4. The screen will return to previous screen automatically after clearing HIGH SCORE data.

OPTIONAL SETTING

1. HIGH SCORE CLEAR
 2. GUN ADJUST DEFAULT
 3. RETURN TO TEST MENU
- PRESS START BUTTON TO CHOOSE
PRESS GUN TRIGGER TO SELECT

HIGH SCORE CLEAR

ARE YOU SURE YOU WANT TO CLEAR
HIGH SCORE?
YES
→ NO

PRESS START BUTTON TO CHOOSE
PRESS GUN TRIGGER TO SELECT

NOTE: Do not proceed if Gun test is accurate.

GUN DATA DEFAULT

If you have problem with Gun sighting , you may have to clear the Gun data.

After clearing Gun data, the game will be reset to **factory default setting**.

See the following for how to clear saved data.

1. Enter TEST MENU and select OPTIONAL SETTING.
2. Press START BUTTON to choose GUN ADJUST DEFAULT.
3. Select YES by pressing START BUTTON and pressing GUN TRIGGER to clear Gun data.
4. The screen will return to previous screen automatically after clearing Gun data.

GUN ADJUST DEFAULT

ARE YOU SURE YOU WANT TO SET
GUN ADJUST DEFAULT?
YES
→ NO

PRESS START BUTTON TO CHOOSE
PRESS GUN TRIGGER TO SELECT

8. REBOOT

Use this screen to go back to normal game mode. After selecting this function, the game will automatically take you to the normal game screen.

Make sure to turn OFF "DIP SWITCH 1, #8" or you will return to test mode upon powering on.

Returning to GAME MODE

You can return to normal game mode by doing one or the other of the following:

Turn OFF "DIP SWITCH 1, #8" and re-power on the game.

Select REBOOT at TEST MENU. (But you will have to make sure to turn OFF "DIP SWITCH 1, #8".)



11. TROUBLE WITH GUN SHOOTING

If you have trouble because you can't shoot to the corner of the screen, you may have to adjust the monitor brightness. Turn up the monitor brightness until you can shoot the corner of screen.

Plus, monitors tend to develop a magnetic field from continuous use, which would cause the gun unit not to function properly. Therefore, it is recommended that the monitor is demagnetized [degaussed] every so often in order to keep the gun unit functioning properly.

In addition, the following conditions of the monitor may result in Gun shooting problems:

- ? Picture burned on monitor screen
- ? Over gauzed monitor
- ? Non adjustable brightness feature

Also, the following conditions of the cabinet may result in Gun shooting problems.

- ? Combination of low performing adjustable brightness monitor and low reflection mirror
- ? Dirty monitor screen or monitor grass

GUNSHOT ACCURACY IMPROVEMENT

If you have trouble because you can't calibrate the gun unit properly. For example you can't shoot corner of screen or you can shoot only in the center of the screen, do the following:

1) CHECK THE +5V LINE **ON THE PCB**. YOU CAN CHECK VOLTAGE AT THE JAMMA EDGE CONNECTOR BETWEEN PIN #2 AND #3.

2) ADJUST +5V LINE TO +5.25V BY TURNING UP POTENTIOMETER ON THE POWER SUPPLY.

WARNING: DO NOT TURN UP VOLTAGE MORE THAN +5.25V OTHERWISE YOUR PCB WILL SUSTAIN SERIOUS DAMAGE.

3) ENTER BACK UP CLEAR IN TEST MODE, THEN SELECT YES TO CLEAR BACK UP DATA.

NOTE: YOU DON'T HAVE TO DO "GUN ADJUST" IN TEST MODE.

4) ENTER GUN TEST IN TEST MODE TO CHECK GUNSHOT. IF THE GUNSHOT IS NOT CORRECTED REPEAT STEP #3.

12. WARRANTY



Limited warranty, Repair and Return Policy

Sammy USA Corporation warrants all products to be free from defective materials and workmanship for a period of thirty (30) days from the Sammy USA Corporation invoice date unless otherwise specified in writing by Sammy USA Corporation. The extent of this warranty applies to all electronic assemblies only, and does not include lamps and fuses.

This limited warranty is invalid for any product that upon examination, is deemed to have been subject to misuse, improper repair or installation, neglect or violation of specification or other instructions published by Sammy USA Corporation.

There are no additional warranties which extend beyond those limited warranties described above.

The limited warranties described above shall be in lieu of any other warranty, express or implied, including but not limited to any implied warranty of merchantability or fitness for a particular purpose.

Return Merchandise Authorization

1. Contact your authorized Sammy USA distributor to receive a Return Merchandise Authorization for return.
2. You must obtain RMA numbers from Sammy USA Corporation through an authorized Sammy USA distributor. Please have your serial number available when calling for an RMA number.
3. All items must have an RMA number marked clearly on the outside of the package.
4. Products must be shipped prepaid. Products returned without an RMA number will not be accepted.
5. Credits to accounts are subject to inspection of products for damage and suitability for resale.

13. ELECTRICAL WIRING DIAGRAM (Trophy, DEDICATED CABINET)

JAMMA Connector (56 pins)
on Main CPU Board

GND	1
GND	A
GND	2
GND	B
+5VDC	3
+5VDC	C
+5VDC	4
+5VDC	D
	5
	E
+12VDC	6
+12VDC	F
KEY	7
KEY	H
COIN METER A	8
	J
COIN LOCKOUT A	9
	K
SPEAKER (+)	10
SPEAKER (-)	L
	11
	M
VIDEO RED	12
VIDEO GREEN	N
VIDEO BLUE	13
VIDEO SYNC	P
VIDEO GND	14
SERVICE CREDIT SWITCH	R
TEST SWITCH	15
	S
COIN SWITCH A	16
	T
1P START BUTTON	17
2P START BUTTON	U
	18
	V
	19
	W
	20
	X
	21
	Y
	22
	Z
	23
	a
	24
	b
	25
	c
	26
	d
GND	27
GND	e
GND	28
GND	f

**Sub Connector CN6 (4 pins)
on Main CPU Board (1P GUN)**

	1
1P PUMP SW	2
1P PUMP SW GND	3
	4

**Sub Connector CN5 (4 pins)
on Main CPU Board (1P GUN)**

+5VDC	7
1P TRIGGER SW	8
GROUND	9
OPTICAL	10

**Sub Connector CN8 (4 pins)
on Main CPU Board (2P GUN)**

	1
2P PUMP SW	2
2P PUMP SW GND	3
	4

**Sub Connector CN7 (4 pins)
on Main CPU Board (2P GUN)**

+5VDC	7
2P TRIGGER SW	8
GROUND	9
OPTICAL	10

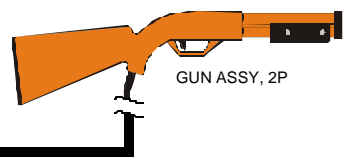
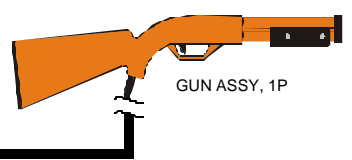
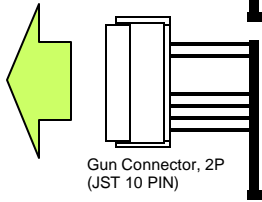
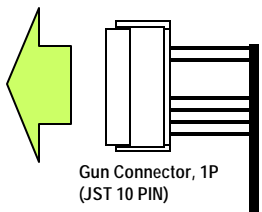
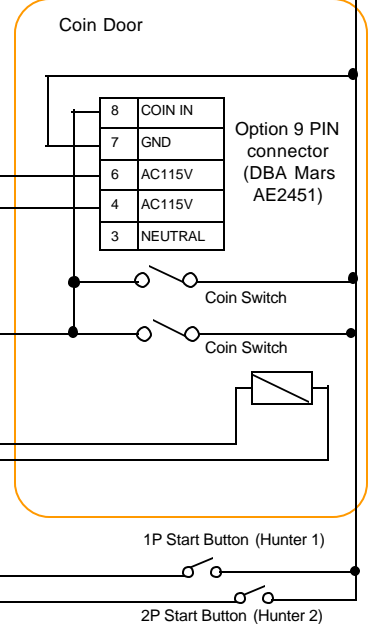
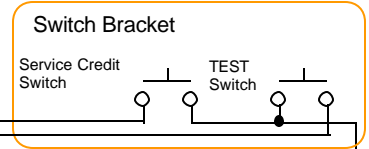
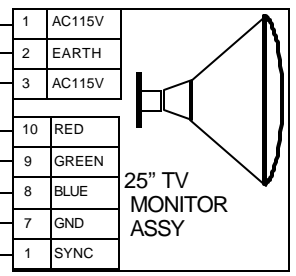
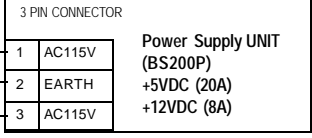
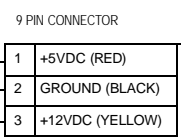
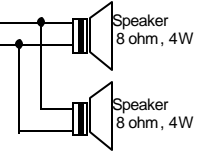
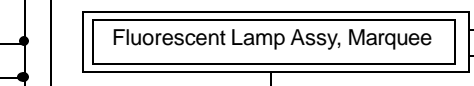

A/C Line cord

