

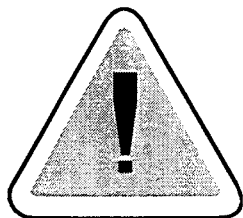

TM

© ARIKA CO., LTD. 1998,
© CAPCOM CO., LTD. 1998,
© CAPCOM U.S.A., INC. 1998 ALL RIGHTS RESERVED.

OPERATORS MANUAL



WARNING

This game is for use in the United States of America and Canada. Sales, export or operation outside of these countries may be constructed as copyright and trademark infringements and is strictly prohibited. Violators are subject to severe penalties and will be prosecuted to the full extent of the law.

SFET1300
050598

THANK YOU FOR PURCHASING *STREET FIGHTER EX2*[™]. WE INVITE YOU TO USE THE FOLLOWING MAILING ADDRESS, TELEPHONE OR FAX NUMBER FOR PARTS OR SERVICE INFORMATION CONCERNING THIS GAME:

CAPCOM[®] COIN-OP, INC.
ATTN: CUSTOMER SERVICE
475 OAKMEAD PARKWAY
SUNNYVALE, CA 94086
PHONE: (408) 522-5325
FAX: (408) 522-5331

THE SERIAL NUMBERS OF YOUR GAME ARE LOCATED ON THE PRINTED CIRCUIT BOARDS AS SHOWN BELOW. PLEASE HAVE THESE SERIAL NUMBERS AVAILABLE WHEN CONTACTING US FOR SERVICE INFORMATION.

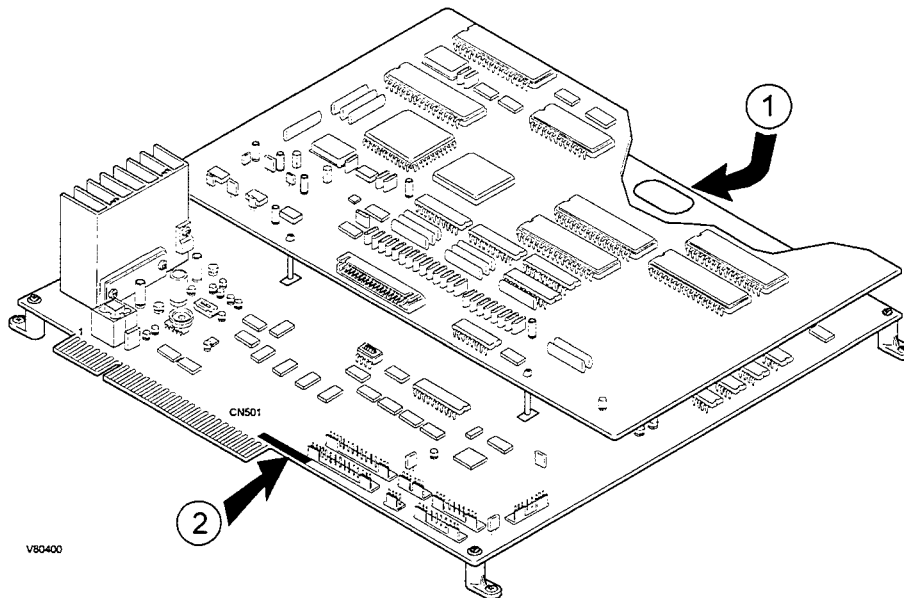

PLEASE RECORD THE PC BOARD SERIAL NUMBERS HERE:

1) LOWER PC BOARD - SOLDER SIDE:

AAMA SERIAL NUMBER: _____

2) LOWER PC BOARD - COMPONENT SIDE:

CAPCOM SERIAL NUMBER: _____

TABLE OF CONTENTS

<i>Caution</i>	i
<i>Warranty Information</i>	ii
<i>Kit Inspection, Kit parts List</i>	1
<i>Kit Installation</i>	
Preparation	2
Installation	2
Marquee	2
Control Panel Overlay	2
Control Panel Component	2, 3
Cabinet Decals	3
PC Board Installation	5
System Wiring	
Control Panel	3
Test/Volume Bracket	4
Speakers	4
Q-Sound Modification	4
PC Boards	5
<i>Test Menu & Game Adjustments</i>	
Test Menu	6
Accessing the Menu	6
How to Select an Item	6
Closing the Menu	6
Menu Item Descriptions	6
Configuration Menu	7
System Configuration	8
Game Configuration	9
<i>Reference Information</i>	
JAMMA Connections	10
Auxiliary Cable Connections	10

CAUTION

Please read the following instructions to keep the PC boards in good condition:

- Do not drop or bump the boards.
- Do not spill any liquids on the boards.

DISASSEMBLING THE BOARDS OR REMOVING STICKERS MAY CAUSE THE TERMINATION OF YOUR REPAIR WARRANTY.

**LIMITED PRODUCT WARRANTY
(APPLIES TO DOMESTIC SALES ONLY)**

CAPCOM® COIN-OP, INC. (Seller), warrants only to the initial purchaser of its products, that the items listed below are free from defects in material and workmanship under normal use and service for the warranty periods specified:

- | | | |
|----|---------------------------------------|------------------|
| A. | Printed Circuit Boards: | Ninety (90) Days |
| B. | Electronic and Mechanical Components: | Ninety (90) Days |

No other part of Seller's products are warranted.

Warranty periods are effective from the initial date of shipment from seller to its authorized distributors.

Seller's sole liability shall be, at its option, to repair or replace products which are returned to Seller during the warranty periods specified, provided:

- A. Seller is notified promptly upon discovery by buyer that stated products are defective;
- B. Such products are properly packaged and then returned, prepaid to Seller's designated plant.

This warranty does not apply to any parts damaged during shipment or handling, or due to improper installation or usage, or alteration. In no event shall Seller be liable for any anticipated profits, loss of profits, loss of use, incidental or consequential damages or any other losses incurred by the customer in connection with the purchase of a CAPCOM® COIN-OP, INC. product.

WARRANTY DISCLAIMER

EXCEPT AS SPECIFICALLY PROVIDED IN A WRITTEN CONTRACT BETWEEN SELLER AND PURCHASER, THERE ARE NO OTHER WARRANTIES, EXPRESSED OR IMPLIED, INCLUDING ANY IMPLIED WARRANTIES OF MERCHANTABILITY OR FITNESS FOR A PARTICULAR PURPOSE.

IMPORTANT NOTICE

THIS SHIPMENT HAS BEEN CAREFULLY INSPECTED AND PROPERLY PACKAGED BEFORE LEAVING THE FACTORY. WE CANNOT ASSUME RESPONSIBILITY FOR BREAKAGE THAT MAY OCCUR DURING TRANSPORTATION OF THE GAME. IF THIS GAME IS DAMAGED UPON RECEIPT FROM THE CARRIER, IMMEDIATELY NOTIFY THE CARRIER AND FILE A DAMAGE REPORT.

KIT INSPECTION

Check that all of the following parts have been shipped with your kit. If any parts are missing, contact your distributor immediately.

1000	1000E	PART NO.	DESCRIPTION	QTY
√	√	SFET1400	Assy, PCB, PSX System, "STREET FIGHTER EX2"	1
√	√	13-0154	Standoff w/Screw, PCB Mounting	4
√	√	03-0104	Harness, Stereo Speaker	1
√	√	03-0105	Cable, Auxiliary	1
√	√	SFET1110	Marquee, "STREET FIGHTER EX2"	1
√	√	SFET2520-01	Decal - Top, Game Play Inst., "STREET FIGHTER EX2"	1
√	√	SFET2520-02	Decal - Bottom , Game Play Inst., "STREET FIGHTER EX2"	1
√	√	AW00245-2	Decal, Joystick & Button Switches, "STREET FIGHTER EX2"	1
√	√	SFET1300	Manual, Operators, "STREET FIGHTER EX2"	1
√	√	AW00147	Decal, Cabinet Side	2
√		GE1200	Monitor Card	1
√		PL00376	Plex, Marquee, Clear, 27.0 x 9.0 x 1/8"	1
√		AW00216	Overlay, Control Panel	1
√		GE2030	Joystick, 8 Way	2
√		16-0130	Switch, 1-Player Start Button (White)	1
√		16-0131	Switch, 2-Player Start Button (White)	1
√		16-0133	Switch, Button (Red)	4
√		16-0134	Switch, Button (Blue)	4
√		16-0136	Switch, Button (Green)	4

Note: Because of availability, your kit may contain different color of push-buttons.

KIT INSTALLATION



WARNING:

MAKE SURE ELECTRICAL POWER TO THE GAME IS OFF BEFORE STARTING THE KIT INSTALLATION.

PREPARATION

1. Disconnect and remove the old printed circuit board(s) from the cabinet.
2. Remove or open the control panel, and disconnect and remove the buttons and joystick(s) from the control panel.
3. Remove any covering from the control panel overlay, and then remove the control panel overlay.
4. Determine where any new holes should go. Center punch any needed new holes on the control panel.
5. Cut out the new holes using a 1-3/16" hole saw.
6. If there is an additional control panel cover, Figure 1 (such as plastic or lexan) that will be utilized, cut any additional holes using the same template.
*Cover is not included in the kit.
7. Plug up unused holes with a wood dowel (1-1/8" diameter) and sand any rough edges.

INSTALLATION

Marquee Installation

8. Remove the marquee plexi glass, marquee overlay, and the cabinet graphics.
9. Install the new marquee and replace the plexi glass. Clear plexi glass is included in "Full" kit.

Control Panel Overlay Installation (See Figure 1)

10. The control panel overlay in the kit is oversized to accommodate most control panel sizes. Center the overlay on the control panel, leaving some excess material at the edges.
11. Remove the protective backing from the overlay and press it down on the control panel, keeping it properly aligned. Press it down firmly, smooth out any bubbles, and press it over the edges.

12. Trim any excess from the overlay. Place the drill hole template on top of the overlay, aligning it with the joystick holes. Pierce through the overlay at each control panel hole. Then, cut away overlay material covering the joystick and button holes. Remove the template and clean off the overlay.

13. Peel off the backings of the 4-button and joystick decals, align over the control panel holes, and press in place on the overlay (refer to the drill hole template for proper placement). Using a knife, trim material from the center hole of the joystick decal.

14. Install the control panel cover, FIG.1. (if required).

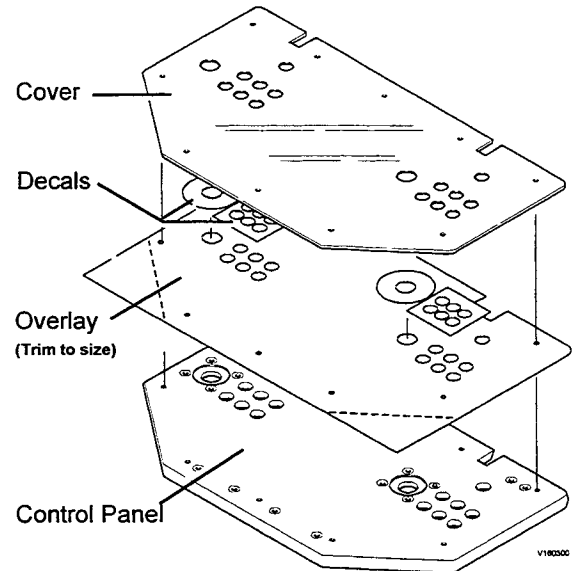

Figure 1: Overlay Installation

Re-assembly of Components

15. Notice that there are two white buttons. See Figure 2. The WHITE buttons are START buttons. Install the PLAYER ONE button on the top left-hand side of the control panel, and the PLAYER TWO button on the top right-side of the control panel.

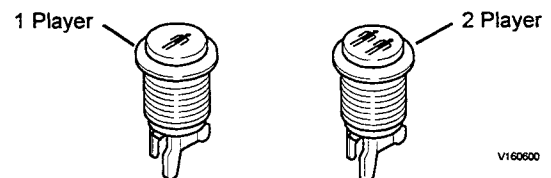

Figure 2: Start Buttons

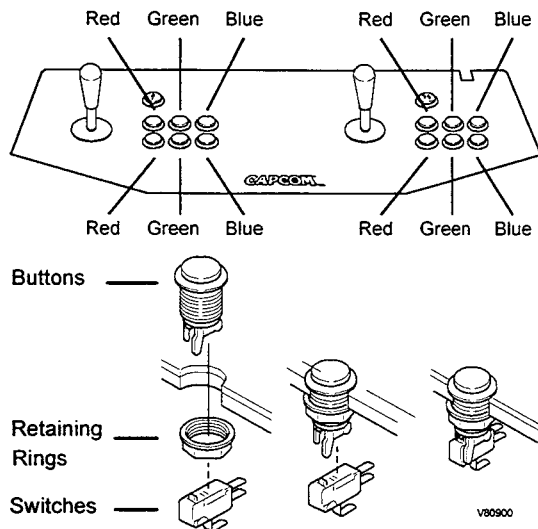

Figure 3: Control Panel Buttons and Switches

16. Install all buttons and retaining rings on the control panel as shown in Figure 3. Install two RED buttons to the immediate right of each joystick, install two GREEN buttons to the right of the red ones.

17. Install the switches on the buttons as shown in Figure 2. Orient the switches so that when a button is pressed, the red contact on the switch is depressed.

18. Install the joysticks on the control panel as shown in Figure 4.

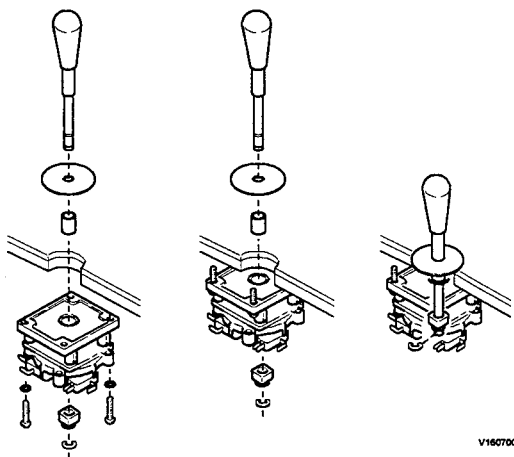

Figure 4: Joystick Installation

CABINET DECAL INSTALLATION

19. Remove monitor glass and install monitor card
20. Peel-off the backing to the instruction decals and place on both the top and bottom of the monitor card. (See Figure 5). Also, apply the cabinet decals to both sides of the cabinet.

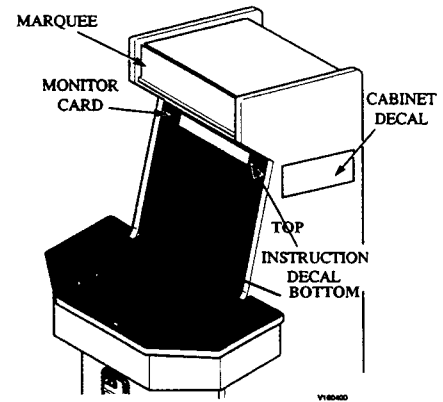

Figure 5: Cabinet Decal Installation

CONTROL PANEL WIRING

NOTE: All switch wires used in this game must be wired to the normally-open connection on the switches. Each switch requires a ground wire on the common connector and the appropriate control or switch wire on the normally-open connector of the switch.

21. Reconnect the existing JAMMA connectors to the control panel according to the chart in Page 10.

22. Connect the Player 1 and the Player 2 KICK buttons to the auxiliary cable harness as shown in Figure 6. Make the connections according to the chart in Page 10.

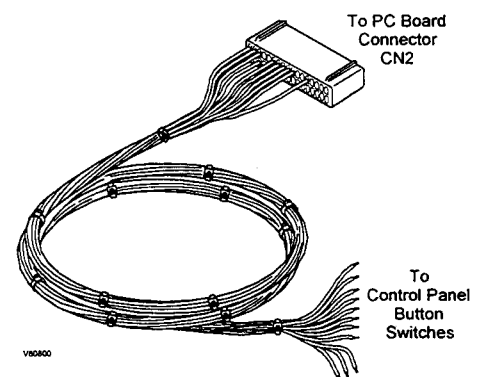

Figure 6: Auxiliary Cable Harness

TEST/VOLUME BRACKET WIRING

23. An optional Test Switch bracket (see Figure 7) is available through your distributor.
(CAPCOM Part number 03-0050).

Your cabinet may already contain this bracket. When installing, the bracket should be mounted inside the coin door and on top of the cash box for easy access.

NOTE: Only the Test switch is used for this game; the Volume Up/Down switches are not used.

Volume adjustments must be made through the volume control knob located on the PC board.

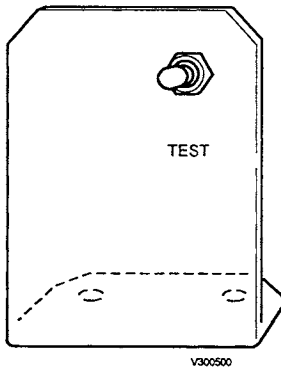

Figure 7: Test Switch Bracket

Wiring of the Test Bracket requires connections to the main JAMMA harness as shown in Table 3:

LEAD WIRE COLOR	SWITCH FUNCTION	CONNECTS TO
YELLOW	VOLUME-UP	NO CONNECTION
BLACK	VOLUME-DOWN	NO CONNECTION
GREEN	COMMON	NO CONNECTION
BROWN	TEST	JAMMA "15"
BLACK	GROUND	JAMMA "A" or "B" or "e" or "f" or "1" or "2" or "27" or "28"

Table 3: Test Bracket Wiring Chart

SPEAKER WIRING

24a. If you are converting a cabinet that is not equipped with CAPCOM® Q-SOUND, the leads from the speaker harness (supplied with this kit) must be wired to the cabinet speakers according to the TABLE 4.

SPEAKER (TERMINAL)	WIRE COLOR
LEFT (+)	WHITE
LEFT (-)	GRAY
RIGHT (-)	BROWN
RIGHT (+)	ORANGE

Table 4: Speaker Wiring Chart

24b. If you are converting a cabinet that is equipped with CAPCOM® Q-SOUND, you may elect to wire directly to the cabinet speaker terminals, as shown above, or you can obtain the same result by performing the following modification (see Figure 8):

i) Disconnect the speaker harness connector from the Q-SOUND board at location CB8.

NOTE: EXTERNAL Q-SOUND POWER AMPLIFIER MUST DISCONNECTED WITH THIS PSX SYSTEM PCB.

ii) Install a 4-pin, 0.156 inch diameter header connector (not supplied with this kit; purchase locally) onto the speaker harness connector.

iii) Insert each wire lead from the supplied speaker harness to each corresponding pin from a 4-pin, 0.156 inch diameter female connector (not supplied with this kit; purchase locally).

iv) Push the female connector and the header connector pins together.

v) Your cabinet is now equipped to receive stereo sound from the PC board.

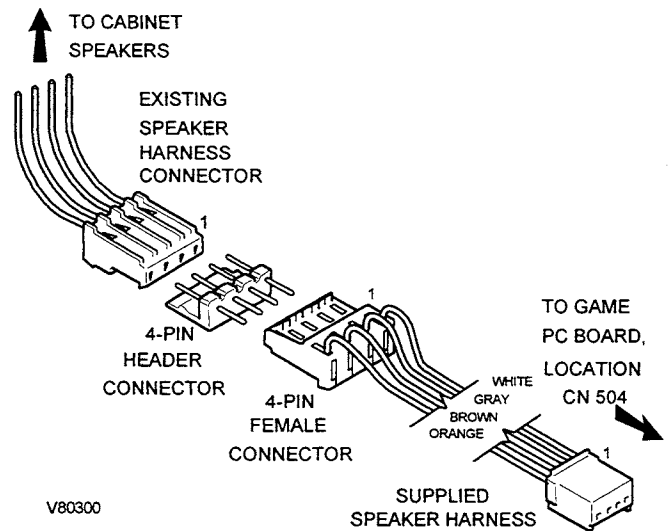

Figure 8: Q-SOUND Modification

PC BOARD INSTALLATION

25. Install the four (4) mounting standoffs to the underside of the PC board by securing with the supplied machine screws. Then, fasten the PC board standoffs to the control panel shelf with wood screws, as shown in Figure 11.

Wood Screws are not included in the kit.

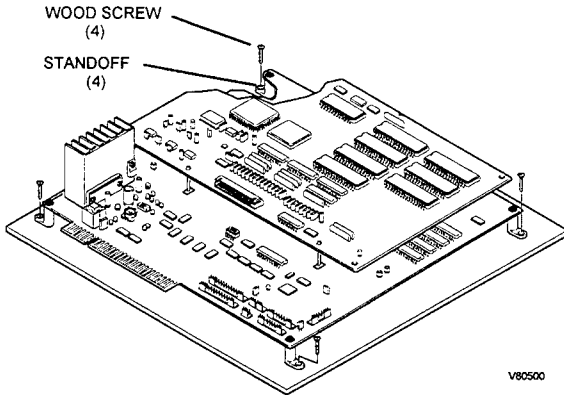



Figure 9: PC Board Mounting

PC BOARD WIRING CONNECTIONS AND ADJUSTMENTS

26. Connect the JAMMA harness connector to the edge connector located on the bottom PC board (see Figure 10).



WARNING

IMPROPER INSTALLATION OF THE JAMMA HARNESS CONNECTOR TO THE PC BOARD WILL CAUSE DAMAGE TO THE PC BOARD.

27. Attach the auxiliary cable connector to the top PC board at location CN2 (see Figure 10).

28. Attach the speaker harness connector to the PC board at location CN504 (see Figure 10).

29. Check that the mode switch, on the lower PC board, is set to "STEREO" (see Figure 10).

30. Check that all 4 positions of the DIP switch are set to OFF (see Figure 10).

31. Power-up the game and adjust the speaker volume by turning the Volume Control knob clockwise to increase volume, or counterclockwise to decrease volume (see Figure 10).

32. Set all operator adjustable options by pressing the TEST switch. Follow the instructions under the *TEST MENU* section of this manual.

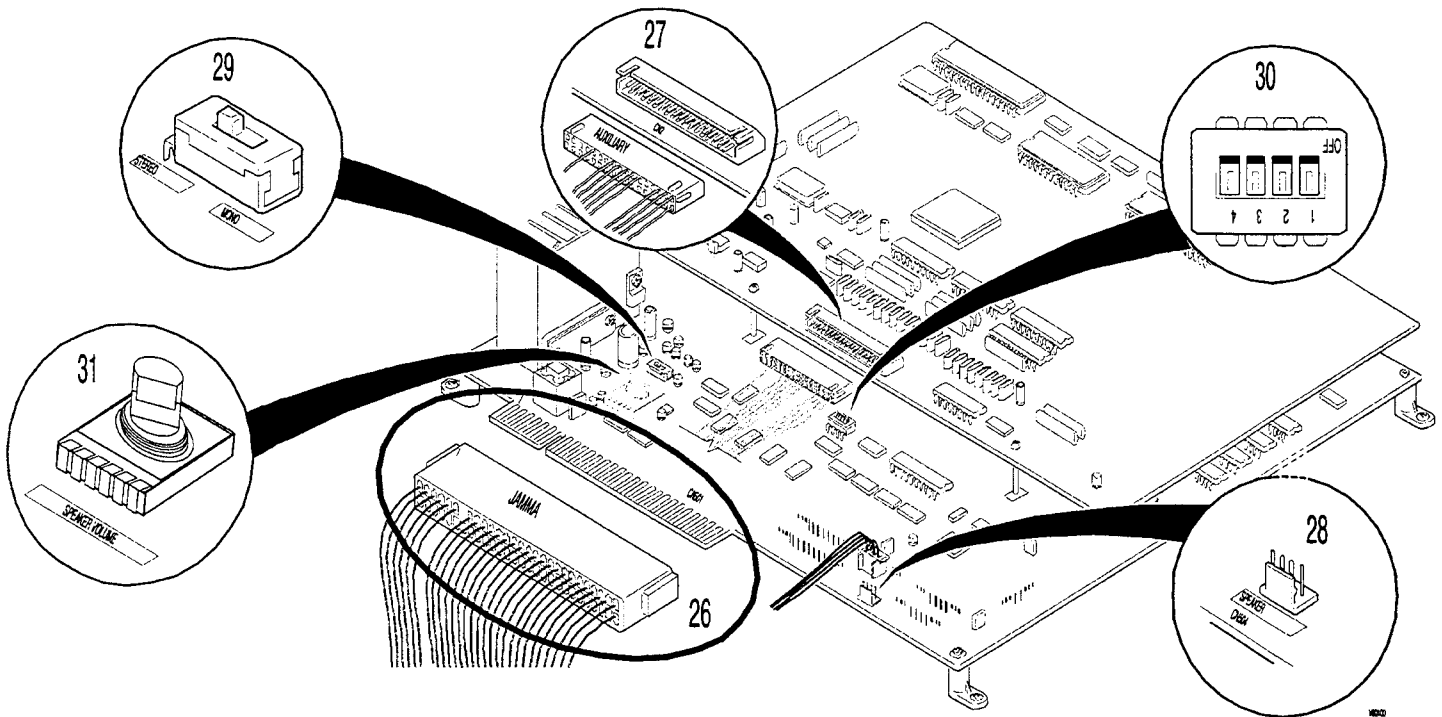
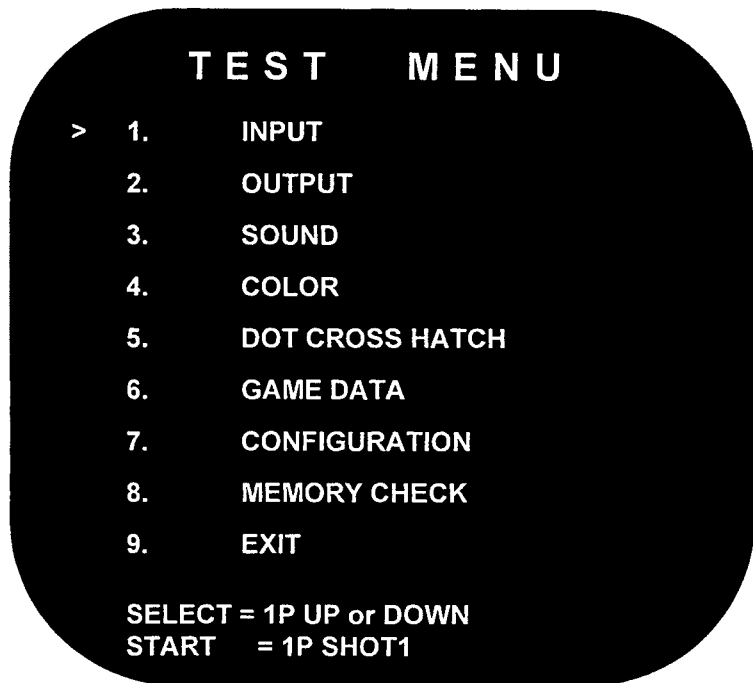

Figure 10: PC Board Wiring Connections & Adjustments

TEST MENU

The test menu allows you to test the functions and configure the game. These items include input devices such as joysticks, buttons and coin door or switches, output devices such as monitor, speakers and meters. Through the Test Menu you can also access the Configuration Menu, where you can change the settings of the game.



1. ACCESSING THE TEST MENU

- For a CAPCOM® cabinet, or a cabinet with a test switch:

Make sure the game is on and push the test switch. The screen shown left will appear.

- For a cabinet without a test switch:

You need install test switch to your cabinet. Please refer Page 4 for test switch installation.

2. HOW TO SELECT AN ITEM

- Use the *PLAYER 1 JOYSTICK* to move the arrow in front of the desired item and press the *PLAYER 1 SHOT 1* button, as shown below in various control panel configurations:

3. CLOSING THE TEST MENU

To close the Test Menu, highlight "9. EXIT" and push the *PLAYER 1 SHOT 1* button.

- To return to the test menu, push the *PLAYER 1 START* and *PLAYER 1 SHOT 1* buttons simultaneously.

- The test menu will always return to the screen:

- After you exit the "7. CONFIGURATION MENU" and
- After the memory is tested from the menu, "8. MEMORY CHECK".

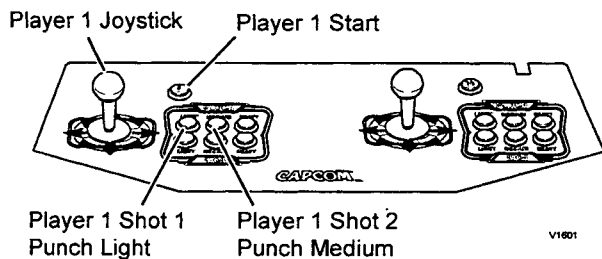

4. TEST MENU ITEM DESCRIPTIONS

INPUT	Used to test all the input switches, such as joysticks and buttons. The "0" changes to a "1" as the button is pushed or joystick is moved. Check connections and switches in case the "0" doesn't change to a "1" when depressed or moved.
OUTPUT	Used to test the coin meter and the coin lock.
SOUND	Select a code of SOUND with the <i>PLAYER 1 JOYSTICK</i> . Push the <i>PLAYER 1 SHOT 1</i> button to hear the sound of the selected code.
COLOR	Shows color bars of red, green, blue, and white. Adjust RGB and brightness to obtain the optimum color balance and solid black background.
DOT CROSS HATCH	Used to test the screen size, focus and distortion.
GAME DATA	Coin meter, Free play and Average Time information will be displayed.
CONFIGURATION	Used to change the game play settings. Refer to the CONFIGURATION MENU section.
MEMORY CHECK	Used to test memory. "OK" appears when each block of memory passes test, "NG" appears in case of malfunction. If "NG" appears, repeat the memory test and wait for the "OK" message. Contact your distributor if "NG" still appears.
EXIT	Select this item and push the <i>PLAYER 1 SHOT 1</i> button to return to game play mode.

CONFIGURATION MENU

The Configuration Menu is used to change various game settings such as level difficulty, credits, sound configuration, etc. These settings are stored in memory on the PCB.

The Configuration Menu is divided into 2 sections. In the **SYSTEM** section, you can change credits, sound, and coin door configurations. In the **GAME** section, you can change the play difficulty level and duration of the game.

7. CONFIGURATION MENU

- > 1. SYSTEM
- 2. GAME
- 3. DEFAULT
- 4. SAVE & EXIT

SELECT = 1P UP OR DOWN
START = 1P SHOT1

1. ACCESSING THE CONFIGURATION MENU

- From the **TEST MENU**, move the arrow to "7. CONFIGURATION" and push the *PLAYER 1 SHOT 1* button. The screen left will be displayed. A description of each option is explained in the table below.

5. CONFIGURATION MENU ITEM DESCRIPTIONS

SYSTEM	Select this item to change settings for credits, sound and coin door configurations.
GAME	Select this item to change difficulty level, damage level, time count speed, maximum number of rounds and event type.
DEFAULT	Use this item to restore configuration settings to the original factory values. Press the <i>PLAYER 1 SHOT 1</i> and <i>PLAYER 1 SHOT 2</i> buttons at the same time to restore default values.
SAVE & EXIT	Use this to save new configuration settings and exit to the Test Menu. The message "SAVING NEW CONFIGURATION IN EEPROM" will appear while the new settings are being saved. DO NOT turn power off to the game until "SAVING" is complete and the Test Menu reappears.

SYSTEM CONFIGURATION

7-1. SYSTEM CONFIGURATION

- > 1. COIN MODE 2 COIN 1 CREDIT
- 2. CHUTE TYPE 2 CHUTES SINGLE
- 3. CONTINUE ON
- 4. DEMO SOUND ON
- 5. SOUND MODE STEREO (Q SOUND)
- 6. REGULATION ON
- 7. EXIT

SELECT OPTION = 1P UP OR DOWN
 MODIFY SETTING = 1P LEFT OR RIGHT
 = 1P SHOT1 OR SHOT2

CHANGING THE SYSTEM CONFIGURATION SETTINGS

Move the *PLAYER 1 JOYSTICK* up or down to highlight the desired option. Once the option is highlighted, move the *PLAYER 1 JOYSTICK* left or right or press the *PLAYER 1 SHOT 1* button to select.

SYSTEM CONFIGURATION ITEM DESCRIPTIONS

1. COIN MODE	SELECT THE CHARGE PER PLAY.
2. CHUTE TYPE	SELECT THE NUMBER OF PLAYER(S) AND COIN CHUTES. 1 CHUTE SINGLE: WITH THIS SETTING, EITHER PLAYER CAN START THE GAME. 2 CHUTES SINGLE: TWO PLAYERS USE ONE COIN CHUTE AND PLAY AT THE SAME TIME. THE PLAYER WHOSE COIN WAS PUT IN FIRST STARTS THE GAME. 2 CHUTES MULTI: TWO PLAYERS USE TWO COIN CHUTES AND PLAY SEPARATELY. THE GAME STARTS FROM THE SAME SIDE AS THE COIN CHUTE WAS USED.
3. CONTINUE	SELECT ON FOR CONTINUOUS PLAY OR OFF FOR NON-CONTINUOUS PLAY.
4. DEMO SOUND	URNS ATTRACT SOUNDS ON OR OFF.
5. SOUND MODE	SELECT STEREO(Q SOUND) OR MONAURAL FOR USE WITH YOUR CABINET. NOTE: STEREO(Q SOUND) SHOULD ONLY BE SELECTED WHEN THE CABINET SPEAKERS HAVE BEEN CONNECTED TO THE GAME PC BOARD AT LOCATION CN504. SEE PAGE 4, SPEAKER WIRING. EXTERNAL Q-SOUND POWER AMPLIFIER IS NOT USED FOR THIS GAME. (SEE PAGE 6 FOR DETAILS)
6. REGULATION	IF SET TO "ON" THE COLOR OF THE BLOOD CHANGES FROM RED TO GREEN.
7. EXIT	TO SAVE THE SETTINGS AND RETURN TO THE CONFIGURATION MENU, HIGHLIGHT THIS ITEM AND PUSH EITHER THE <i>PLAYER 1 SHOT 1</i> BUTTON OR THE <i>PLAYER 1 SHOT 2</i> BUTTON.

SYSTEM CONFIGURATION OPTION SETTINGS

1. COIN MODE	1 COIN 1 CREDIT	1 COIN 2 CREDITS	1 COIN 3 CREDITS	1 COIN 4 CREDITS	1 COIN 5 CREDITS
	1 COIN 6 CREDITS	1 COIN 7 CREDITS	1 COIN 8 CREDITS	1 COIN 9 CREDITS	2 COINS 1 CREDIT
	3 COINS 1 CREDIT	4 COINS 1 CREDIT	5 COINS 1 CREDIT	6 COINS 1 CREDIT	7 COINS 1 CREDIT
	8 COINS 1 CREDIT	9 COINS 1 CREDIT	2 COINS START 1 COIN CONTINUE	FREE PLAY	
2. CHUTE TYPE	2 CHUTES SINGLE		2 CHUTES MULTI	1 CHUTE SINGLE	
3. CONTINUE	ON			OFF	
4. DEMO SOUND	ON			OFF	
5. SOUND MODE	STEREO (Q SOUND)			MONAURAL	
6. REGULATION	ON			OFF	

NOTE:

FACTORY SETTING

GAME CONFIGURATION

7-2. GAME CONFIGURATION

- > 1. DIFFICULTY EASY[.3.....]HARD
- 2. DAMAGE LEVEL LOW[...4....]HIGH
- 3. TIME COUNT SLOW[.2..]FAST
- 4. MAX-ROUND[CPU] 3 ROUND
- 4. MAX-ROUND[VS] 3 ROUND
- 6. EVENT OFF
- 7. EXIT

SELECT OPTION = 1P UP OR DOWN
 MODIFY SETTINGS = 1P LEFT OR RIGHT
 1P SHOT1 OR SHOT2

CHANGING THE GAME CONFIGURATION SETTINGS

Move the *PLAYER 1 JOYSTICK* up or down to highlight the desired option. Once the option is highlighted, move the *PLAYER 1 JOYSTICK* left or right or press the *PLAYER 1 SHOT 1* button to select.

ITEM	DESCRIPTION	OPTION SETTINGS			
1. DIFFICULTY	SETS THE GAME DIFFICULTY LEVEL	1 EASY	2	3	4
		5	6	7	8 HARD
2. DAMAGE LEVEL	SETS THE OFFENSIVE POWER LEVEL.	1 LOW	2	3	4
		5	6	7	8 HIGH
3. TIME COUNT SPEED	SETS THE SPEED OF COUNTDOWN FROM THE TIMER DISPLAY.	1 SLOW	2	3	4 FAST
4. MAX-ROUND (VS. CPU)	SET THE NUMBER OF ROUNDS PER MATCH FOR VS. "CPU" DEFAULT IS SET AT 3 ROUNDS.	1 ROUND	3 ROUNDS	5 ROUNDS	
5. MAX-ROUND (VS. PLAYER)	SET THE NUMBER OF ROUNDS PER MATCH FOR VS. "PLAYER" DEFAULT IS SET AT 3 ROUNDS. 1 ROUND AND 5 ROUNDS ARE CONVENIENT FOR A GAME EVENT (TOURNAMENT ETC.).	1 ROUND	3 ROUNDS	5 ROUNDS	
6. EVENT	SPECIAL SETTING FOR TOURNAMENT EVENT. 1 MATCH: ONLY ONE CREDIT IS REQUIRED FOR A 2P GAME. THE GAME ENDS AFTER ONE MATCH REGARDLESS OF THE RESULT.	ON		OFF	
7. EXIT	RETURN TO THE CONFIGURATION MENU.				

NOTE: FACTORY SETTING

JAMMA Connections

SOLDER SIDE			COMPONENT SIDE
GND	A	1	GND
GND	B	2	GND
+5V DC	C	3	+5V DC
+5V DC	D	4	+5V DC
N/C.	E	5	N/C.
+12V DC	F	6	+12V DC
KEY	H	7	KEY
N/C	J	8	COIN COUNTER 1
COIN LOCK 2	K	9	COIN LOCK 1
*SPEAKER (-)	L	10	*SPEAKER (+)
N/C.	M	11	N/C.
VIDEO GREEN	N	12	VIDEO RED
VIDEO SYNC	P	13	VIDEO BLUE
SERVICE (FREE CREDIT)	R	14	VIDEO GROUND
N/C	S	15	DIAGNOSTICS
2 PLAYER - COIN	T	16	1 PLAYER - COIN
2 PLAYER - START	U	17	1 PLAYER - START
2 PLAYER - UP	V	18	1 PLAYER - UP
2 PLAYER - DOWN	W	19	1 PLAYER - DOWN
2 PLAYER - LEFT	X	20	1 PLAYER - LEFT
2 PLAYER - RIGHT	Y	21	1 PLAYER - RIGHT
2 PLAYER - LIGHT PUNCH	Z	22	1 PLAYER - LIGHT PUNCH
2 PLAYER - MEDIUM PUNCH	a	23	1 PLAYER - MEDIUM PUNCH
2 PLAYER - HEAVY PUNCH	b	24	1 PLAYER - HEAVY PUNCH
N/C	c	25	N/C
N/C	d	26	N/C
GND	e	27	GND
GND	f	28	GND

Auxiliary Cable (P/N 03-0105) Connections

WIRE COLOR	CONNECTOR ODD ROW			CONNECTOR EVEN ROW	WIRE COLOR
	N/C	1	2	N/C	
	N/C	3	4	N/C	
	N/C	5	6	N/C	
	N/C	7	8	N/C	
PURPLE/YELLOW	PLAYER 2 HEAVY KICK	9	10	N/C	
	N/C	11	12	N/C	
	N/C	13	14	N/C	
PINK	PLAYER 1 HEAVY KICK	15	16	N/C	
RED	PLAYER 1 MEDIUM KICK	17	18	N/C	
BLUE	PLAYER 1 LIGHT KICK	19	20	N/C	
GRAY/YELLOW	PLAYER 2 LIGHT KICK	21	22	N/C	
PINK/YELLOW	PLAYER 2 MEDIUM KICK	23	24	N/C	
	N/C	25	26	N/C	
	N/C	27	28	N/C	
	N/C	29	30	N/C	
	N/C	31	32	N/C	
BLACK	PLAYER 2 KICK - COMMON	33	34	PLAYER 1 KICK-COMMON	BLACK

REFERENCE INFORMATION

PC BOARD CONNECTIONS AND CONTROLS

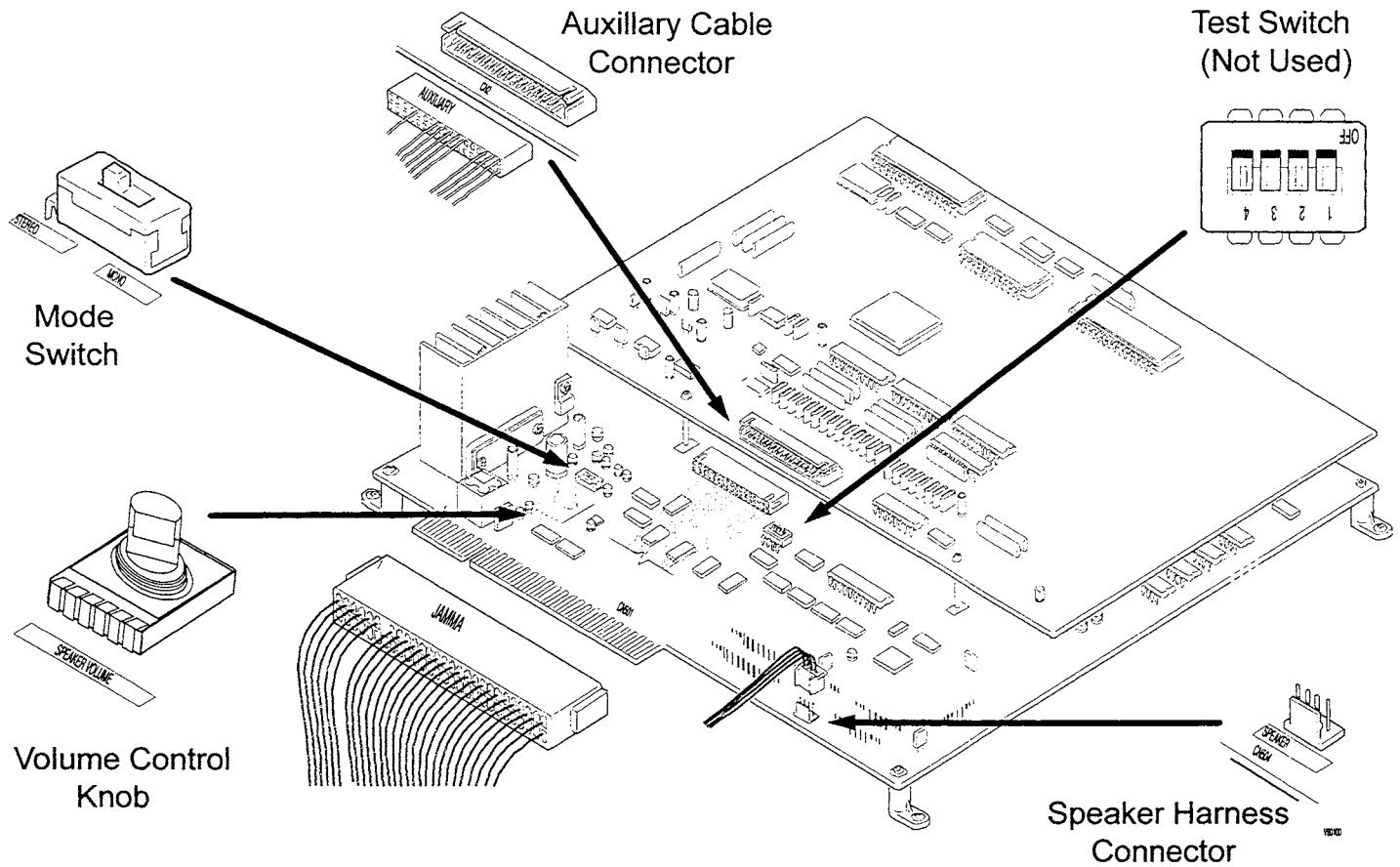

TYPICAL CONTROL PANEL LAYOUTS FOR "STREET FIGHTER EX2™"

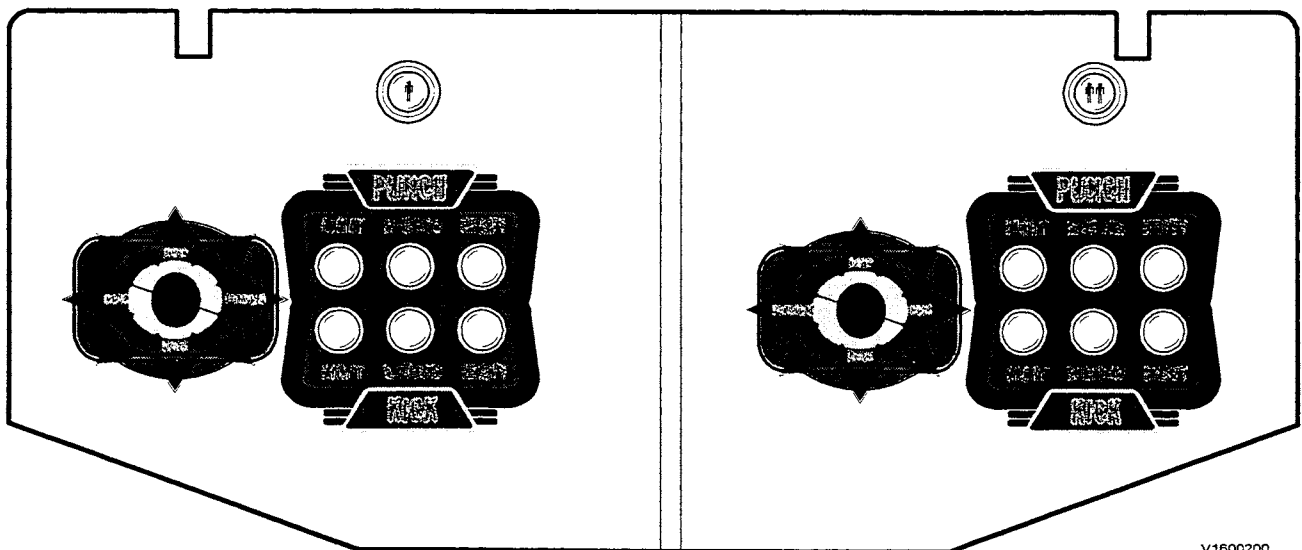

V1600200

NOTICE

This equipment has been tested and found to comply with the limits for a Class A digital device, pursuant to Part 15 of the FCC Rules. These limits are designed to provide reasonable protection against harmful interference when the equipment is operated in a commercial environment. This equipment generates, uses, and can radiate radio frequency energy and, if not installed and used in accordance with the instruction manual, may cause harmful interference to radio communications. Operation of this equipment in a residential area is likely to cause harmful interference, in which case the user will be required to correct the interference at his own expense.

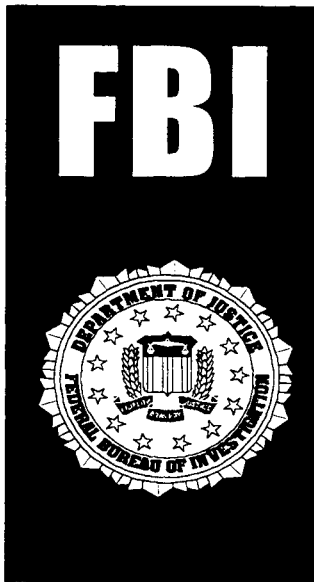

WARNING

Federal law provides severe civil and criminal penalties for the unauthorized reproduction, distribution, or exhibition of copyrighted audiovisual works and video games.

The Federal Bureau of Investigation investigates allegations of criminal copyright infringement.

CAPCOM[®] COIN-OP, INC.
475 Oakmead Parkway
Sunnyvale, CA 94086
Phone: (408) 774-0500
Fax: (408) 522-5331