

# KRUULL



**Instruction Manual**

 **Gottlieb**

# KRULL (GAME GV-105) INSTRUCTION MANUAL

## TABLE OF CONTENTS

SEC.		PAGE
I.	INSTALLATION .....	1
II.	INITIALIZATION .....	3
III.	GAME OPERATION .....	3
IV.	GAME PLAY AND SCORING .....	4
V.	SOUND/SPEECH .....	6
VI.	GAME ADJUSTMENTS/OPTIONS .....	6
VII.	BOOKKEEPING AND SELF TEST .....	7
VIII.	GENERAL INFORMATION .....	9
IX.	THEORY OF OPERATION .....	11
X.	WIRING AND SCHEMATIC DIAGRAMS .....	12
XI.	PARTS INFORMATION .....	33

**WELLS GARDNER MONITOR,  
SERVICE AND OPERATION MANUAL (Attached)**

**WARNING:** This equipment generates, uses, and can radiate radio frequency energy and if not installed and used in accordance with the instructions manual, may cause interference to radio communications. It has been tested and found to comply with the limits for a Class A computing device pursuant to Subpart J of Part 15 of FCC Rules, which are designed to provide reasonable protection against such interference when operated in a commercial environment. Operation of this equipment in a residential area is likely to cause interference in which case the user at his own expense will be required to take whatever measures may be required to correct the interference."

### NOTICE

**WARRANTY INFORMATION IS LOCATED ON THE INSIDE BACK COVER.**

**FOR SERVICE, CALL TOLL FREE: 1-800-323-9121; (ILLINOIS) 1-800-942-1620**

# I. INSTALLATION

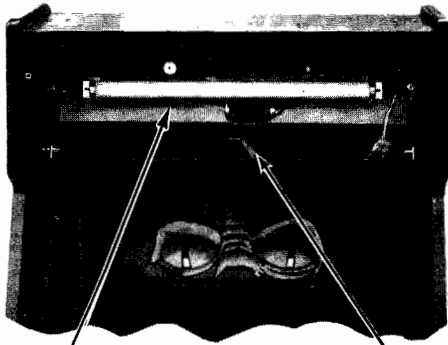

MA-376 ILLUMINATION ASSY.

MA-459 SPEAKER ASSY.

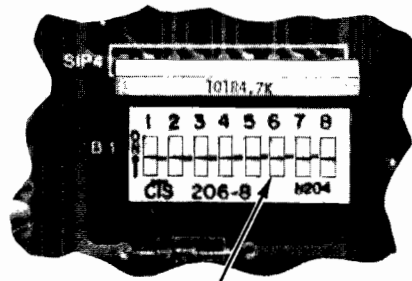

GAME ADJUSTMENT SWITCHES (PART OF AI LOGIC BOARD)

- MA-457 FILTER BOARD ASSY.
- MA-487 A6 SOUND BOARD ASSY.
- MA-492 A3 POWER SUPPLY ASSY.
- MA-456 A1 LOGIC BOARD ASSY.
- MA-1155 MASTER ELECTRONICS BOARD

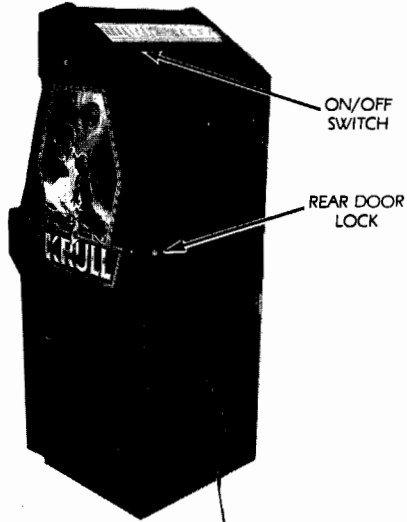
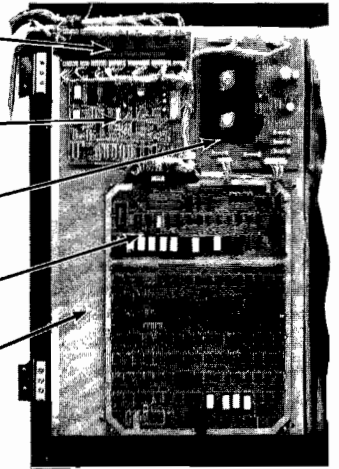

ON/OFF SWITCH

REAR DOOR LOCK

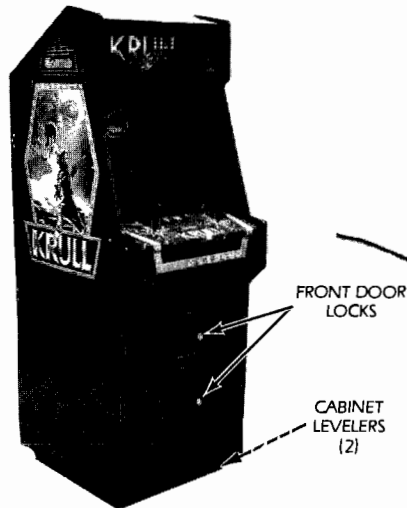

FRONT DOOR LOCKS

CABINET LEVELERS (2)

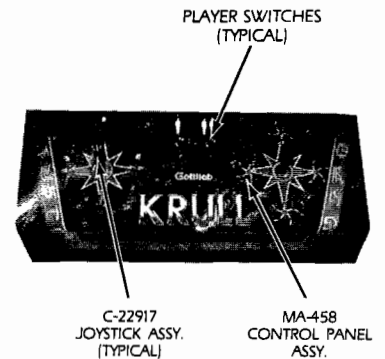
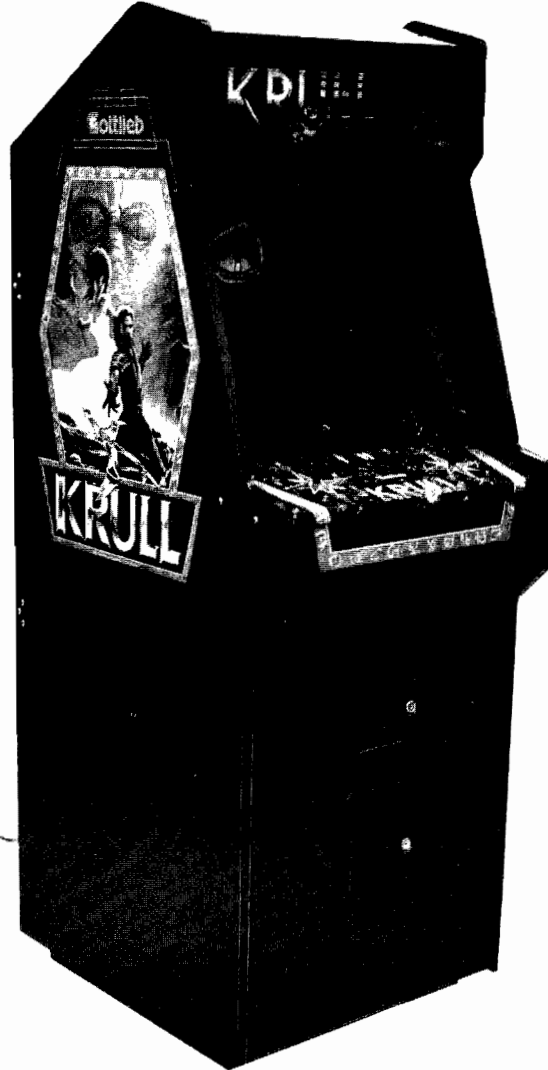

PLAYER SWITCHES (TYPICAL)

C-22917 JOYSTICK ASSY. (TYPICAL)

MA-458 CONTROL PANEL ASSY.

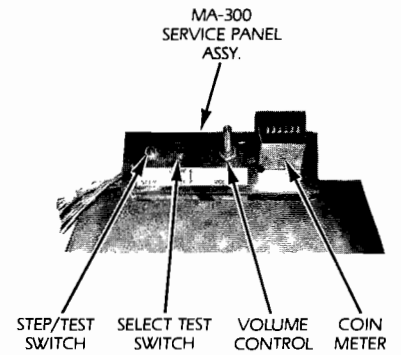

MA-300 SERVICE PANEL ASSY.

STEP/TEST SWITCH SELECT TEST SWITCH VOLUME CONTROL COIN METER

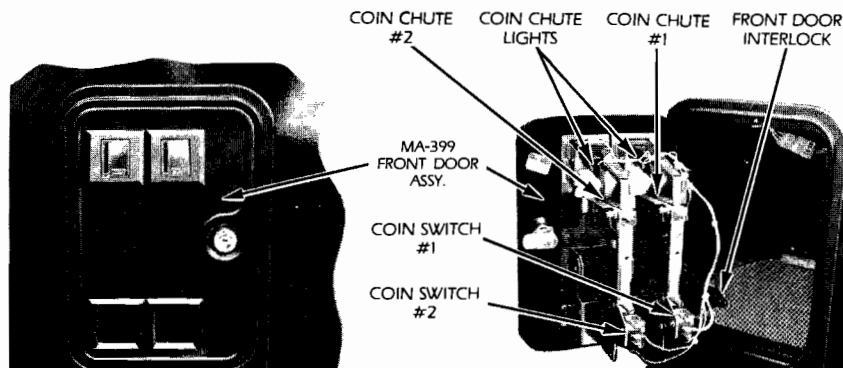

- COIN CHUTE #2
- COIN CHUTE LIGHTS
- COIN CHUTE #1
- FRONT DOOR INTERLOCK
- MA-399 FRONT DOOR ASSY.
- COIN SWITCH #1
- COIN SWITCH #2

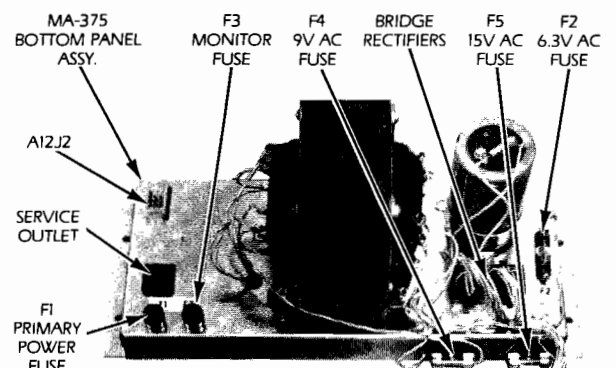

- MA-375 BOTTOM PANEL ASSY.
- F3 MONITOR FUSE
- F4 9V AC FUSE
- BRIDGE RECTIFIERS
- F5 15V AC FUSE
- F2 6.3V AC FUSE
- A12J2
- SERVICE OUTLET
- F1 PRIMARY POWER FUSE

# I. INSTALLATION

## A. SET—UP

1. Carefully inspect the exterior of the game for any damage which might have occurred during shipment.
2. Unlock and open the rear cabinet door.
3. Check that all plug in connectors are seated firmly. The connectors are keyed so they will only go in one way.
4. Remove the binding strap from the line cord, and install the line cord plate in the groove provided (see photo).
5. Cabinet levelers (2) are stored within the cash box for shipping purposes. Install and adjust as necessary.

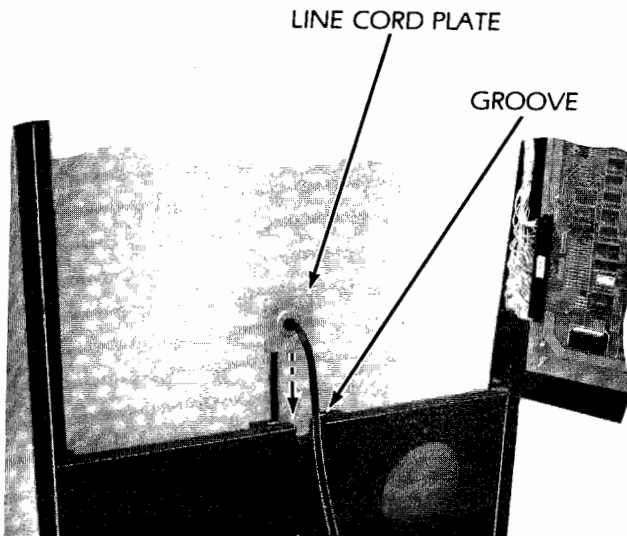

## B. CHECK-OUT

1. Check that all cables are free of moving parts.
2. Check for any loose wires.
3. Check for loose solder or foreign matter on switches and power supply assemblies.
4. Be certain all fuses are seated firmly.
5. Be sure transformer wiring corresponds to the supply voltage.
6. Refer to section VI to make all the necessary game adjustments.
7. Reassemble the game.
8. Plug the line cord into a properly grounded 3-wire receptacle ONLY!!

## C. CONTROL PANEL REMOVAL

1. Unplug the game.
2. Unlock and open the coin chute door.
3. Reach in through the coin chute door and remove the wing nut and flat washer from each of the two carriage bolts which secure the control panel to the game. Unlatch the control panel latch at the top center of the panel. Note where the latch strike plate is located. Remove the carriage bolts.
4. Pull the control panel back, grasp it at the front edge as far back as it will go (approximately 1/4").
5. Raise the front of the control panel approximately one inch above its supports and lift the entire assembly high enough to disconnect plug A9J2/A9P2.
6. Remove the entire control panel assembly from the game.
7. The joystick's and leaf-switches are now accessible for removal or cleaning.
8. For reassembly, reverse the above procedure.

## D. MONITOR REMOVAL

1. Unplug the game.
2. Perform the control panel assembly removal procedure (Section C).
3. Unlock and open the rear cabinet door.
4. NOTE: The color monitor contains HIGH VOLTAGES delivering LETHAL quantities of energy. Do not attempt to service the monitor until you have shorted the anode plug on the picture tube to ground.
5. Disconnect the video plug A17J1, the monitor power supply plug A12J3/A12P3 and the ground wire from the monitor chassis.
6. From the rear of the game, remove the one nut and one washer from each of the four carriage bolts used to secure the monitor to the platform.
7. Remove the monitor from the rear of the game, being careful to clear all cables from the CRT neck.
8. For reassembly, reverse the above procedure.

# I. INSTALLATION, II. INITIALIZATION, III. GAME OPERATION

## I. INSTALLATION

### E. SPEAKER ASSEMBLY AND MARQUEE REMOVAL

1. Unplug the game.
2. Unlock and open the back door.
3. Unplug the A15-J1/PI connector.
4. Unlatch the two latches on the rear of the Speaker Assembly Panel located inside the back door above the monitor.
5. On the front of the game, pull down on the lower molding under the marquee. The Speaker Assembly will lower to allow removal of the marquee.
6. Remove the marquee by lifting it upward out of its track. The Speaker Assembly and Illumination Assembly are now accessible for servicing.
7. Tilt the front of the Speaker Assembly downward while lifting the center upward.

Pull the assembly straight out to remove. Be careful not to pinch the Speaker Assembly cable.

8. For reassembly, reverse the above procedure. When replacing the marquee:
  - a. Tilt the front of the Speaker Assembly downward.
  - b. Place the bottom of the marquee in the lower molding track on the front of the assembly.
  - c. Apply slight pressure with your thumbs to the lower left and right corners of the marquee.
  - d. Slowly raise the Speaker Assembly until the top of the marquee is in place in the upper track in the top molding.
  - e. Be certain to reconnect the A15-J1/PI connector and relatch the rear assembly latches.

## II. INITIALIZATION

### TURN GAME ON

Immediately, the coin chute lamps and the speaker marquee lamp will turn on.

- B. The playing field cycles through the following:

1. High Game to Date screen
2. Instruction Set
3. Game Play Cycle

### AFTER A TEN SECOND DELAY

- A. The attract mode appears on the screen.

## III. GAME OPERATION

### A. GAME START

1. Insert coins into coin chute.
  - a. Coin chute tune is played.
  - b. Total credits are displayed on screen.
2. Press one or two player button to start game.
  - a. Total Credits are decreased by one.
  - b. Game initializes.

### B. FIRST PLAYER

1. The first player's score displays a zero.
2. The other player's display will be blank.

### C. SECOND PLAYER

1. Additional player is indicated by the words "COLWYN 2" and a zero in the second player's display.

### D. COLWYN'S/EXTRA COLWYN'S

1. Each player will begin with three Colwyn's (dependent on Option/Parameter settings).
2. Extra Colwyn's are earned by achieving certain score levels (dependent on Option/Parameter settings).

## IV. GAME PLAY AND SCORING

### HOW TO PLAY

#### CONTROL PANEL

The left joystick controls the movement of the player character, Colwyn. He can be moved in any one of eight directions. The right joystick controls the movement of the player's weapon, the glaive. It can be thrown in any one of eight directions. Four glaives can be in flight at one time and will return to Colwyn with a boomerang-type action. The one and two player select buttons are also located on the panel.

Krull consists of five subgames: (1) The Mountain Game, (2) The Swamp Game, (3) The Fortress Game, (4) The Hexagon Game and (5) The Beast Game. The player must accomplish a task in each of the five games with eight levels of difficulty in each. All eight levels can be reached in one task based on the time spent performing that task (amount of time spent on that subgame). The total number of lethal characters on the screen at one time increases as the levels increase.

"FROM THE SKY WILL COME THE BLACK FORTRESS. FROM THE FORTRESS WILL COME THE SLAYERS, TO DEVOUR THE PLANET OF KRULL. THEN SHALL A GIRL OF ANCIENT NAME BECOME QUEEN, AND THE KING SHE CHOOSES SHALL RULE THE PLANET."

The planet Krull is threatened by the Beast. His army of Slayers has brought terror to the land. Colwyn must stop this terror and save the land and its people. On the day Colwyn is to wed the Princess Lyssa, the Slayers, army of the Beast, kidnap her to become the Beast's bride. Colwyn must reach the Black Fortress and reclaim his Princess. He who marries the Princess shall be king. The Beast must not be allowed to rule the planet.

A prophet acquaints Colwyn with the magical properties of the glaive, a five-bladed sword, which Colwyn must acquire. To accomplish this task, he must climb the mountain and collect the five individual blades of the glaive in order to assemble the weapon. The blade is picked up by touching Colwyn to the blade. Boulders are fatal and must be avoided. The weapon joystick is not

utilized in this subgame. The player is awarded 1000 points for each blade picked up. Points are also awarded for placing Colwyn in a dangerous position in front of one or more boulders.

During his travels to discover the Black Fortress, Colwyn comes upon an army of eight men that he befriends and recruits to help him in his quest to destroy the Beast so that Krull can be safe from his evil.

With no intentions of losing his newly acquired bride without bloodshed, the Beast orders an army of Slayers to stop Colwyn and his friends. Forging through the quicksand-riddled swamps, Slayers materialize from the soil and Colwyn prepares for battle. In the second subgame, Colwyn must save as many friends as possible while killing all of the Slayers. The friends are saved by touching them and the Slayers are destroyed by the glaive. The Slayers themselves and their spears must be avoided. The game begins with eight friends. The number of friends saved is the number of friends carried over into future subgames. The friends can eliminate the Slayers with hand-to-hand combat but can also be destroyed themselves. Receiving three blows either by hand-to-hand or by the Slayer's spear is fatal to the friends. The subgame ends when there are no longer any friends to save and all of the Slayers have been eliminated. Avoid quicksand, as it slows Colwyn's attack. Each friend saved awards 1000 points (maximum 8000 points) and 100 points for each Slayer the player eliminates.

After days of travel, Colwyn and his men have found the Black Fortress in the Iron Desert where many dangers await them. While attempting to lead his men through the dangerous narrow passageways that lead to the Fortress, Slayers materialize once again in a second attempt to stop Colwyn's struggle. In this third subgame, Colwyn must pick up all of his friends and deposit them safely into the hexagon while again combating the Slayers. The total number of friends in this subgame is equal to the total number of friends saved in Subgame 2. This subgame concludes

## IV. GAME PLAY AND SCORING

when all of the friends have been delivered to the hexagon. The player is awarded 1000 points for each friend delivered to the hexagon, 100 points for each Slayer he destroys and 100 points for each Slayer remaining when the last friend is delivered to the hexagon.

Victorious in battle, Colwyn must now attempt to release his friends from the hexagon. Unlike entry, exiting the hexagon is a struggle deserving of its own merit. Once again Colwyn must call upon the power of the glaive. Release of his friends is accomplished by throwing the glaive at the front wall while it is black only. Any glaive striking the wall while it is not black will stick in the wall until the wall becomes black. The Slayers, of course, attempt to stop Colwyn's efforts. In his own attempt for survival, Colwyn must fight them off and avoid their spears. The subgame ends when the last black wall is broken through and the friends have escaped. The player is awarded 100 points for each Slayer he puts an end to, 100 points for each Slayer remaining when the friends are set free and 1000 points for the first black wall destroyed, 2000 points for the second, 3000

points for the third and 4000 points for the fourth.

Now inside the Black Fortress, Colwyn secedes from his friends in order to rescue the Princess Lyssa. He finds her in a large cave carefully guarded by the Beast. He knows that the only way to reclaim his bride and conserve the planet is to forge into battle with the Beast. In the fifth subgame, the player moves Colwyn towards the Princess in order to reach her. As he progresses, the Beast attempts to stop him by throwing fireballs at him. The fireballs must be avoided or destroyed by the glaive. If not destroyed, the fireballs will ricochet off of the walls. Destroying a fireball awards the player 100 points multiplied by the number of fireballs in flight. The Beast is momentarily stunned when hit with a glaive and awards the player 100 points. The Beast cannot be destroyed and the player must avoid touching him. When Colwyn reaches the Princess, his friends, following the pandemonium of the battle, appear and chase the Beast off, awarding 1000 points per friend. The total number of friends in this subgame is equal to the total number of friends saved in Subgame 2.

The word "KRULL" is rendered in a large, bold, serif font with a metallic, three-dimensional appearance. The letters are white with black outlines and shadows. To the right of the word, a glaive (a spear with a crossbar) is depicted in a similar metallic style, pointing to the right. The background is black with some white speckles, suggesting a starry sky or a dark, textured surface. On the far left edge, there are four white vertical bars, resembling a film strip edge.

# V. SOUND, VI. GAME ADJUSTMENTS / OPTIONS

## V. SOUND

The Sound Board installed in this game has been programmed for sound only. The switch bank on the Sound Board is not used and the switch positions have no effect on the sound.

Note: The Sound Board and sound ROM's installed in this game are not compatible with the Sound Board or sound ROM's used on any other game.

## VI. GAME ADJUSTMENTS/OPTIONS

### A. CONTROL BOARD SWITCH ADJUSTMENTS

**SWITCH 1** \_\_\_\_\_ **LIVES PER GAME**  
 OFF ..... 3 LIVES  
 ON ..... 5 LIVES

**SWITCH 2** \_\_\_\_\_ **ATTRACT PLAY**  
 OFF ..... SOUND  
 ON ..... NO SOUND

**SWITCHES**  
**3**    **4** \_\_\_\_\_ **COIN/CREDITS**  
 OFF   OFF ..... 1/1  
 ON    OFF ..... 1/2  
 OFF   ON ..... 2/1  
 ON    ON ..... FREE PLAY

**SWITCH 5** \_\_\_\_\_ **HEXAGON CONTROL**  
 OFF ..... ROVING  
 ON ..... STATIONARY

**SWITCH 6** \_\_\_\_\_ **DIFFICULTY CONTROL**  
 OFF ..... NORMAL  
 ON ..... HARD

**SWITCHES**  
**7**    **8** \_\_\_\_\_ **EXTRA LIVES**

		FIRST EXTRA LIFE	EACH ADDITIONAL LIFE
OFF	OFF	30,000 POINTS	EVERY 50,000 POINTS
OFF	ON	40,000 POINTS	EVERY 50,000 POINTS
ON	OFF	30,000 POINTS	EVERY 30,000 POINTS
ON	ON	50,000 POINTS	EVERY 75,000 POINTS

### B. SOUND ADJUSTMENTS

The audio output is controlled by the potentiometer mounted on the service panel assembly (located inside the coin mechanism door).

Turning the potentiometer counter-clockwise will decrease the volume. Turning it clockwise will increase the volume.

**IMPORTANT:** Each of the potentiometers installed on the Sound board have been factory adjusted. The potentiometer settings should never be changed when performing the recommended calibration procedure.

### C. MONITOR ADJUSTMENTS

Normally, few if any adjustments are required for proper monitor operation. However, after any major repairs to the monitor chassis refer to the attached monitor manual.



## VII. BOOKKEEPING AND SELF TEST

### SELF TEST

The battery back-up bookkeeping functions of this game are contained in Self Test steps 3 and 4. These are in addition to the electro-mechanical coin counter located inside the front door panel. Every time a coin is inserted into a coin slot, the counter is energized, incrementing the count.

The self-test consists of six functions which may be used to identify problems in the video system and to change program parameters.

The self-test mode is entered by setting the self-test toggle switch located inside the cash door to "TEST". A selection of available tests is displayed on the monitor. To return to the GAME mode at any time, the operator needs only to set the toggle switch back to "GAME".

Selection of tests is done with the push button switch labeled "SELECT". Upon entering the test mode, a flashing arrow points to the first test selection. Momentarily depressing the "SELECT" button will advance through each selection one by one.

When the arrow is pointing to the desired test, the operator may begin that test by pressing the "SELECT" button and holding it down until the test appears on the screen.

Once a test has been selected, the operator can return to the selection list by holding down the select switch until it re-appears. The six tests are as follows:

#### 1. MONITOR ADJUSTMENT

Four patterns can be displayed on the screen for adjusting monitor color, brightness, contrast and convergence. The patterns are: Color bars, a cross-hatch, a gray scale, and a dot pattern. By momentarily pressing the select switch, the operator may cycle through the four patterns.

#### 2. MEMORY TEST

For each RAM memory chip: An OK or an NG (no good) appears signaling that the chip is good or bad respectively.

Check sums are displayed for each ROM memory chip. If you have a suspect ROM, refer to your distributor for the correct check sum number.

#### 3. DIP SWITCHES

A functional description of the eight Dip Switches located on the Logic Board Assy. is displayed. Changing any switch will cause an immediate update of the description displayed on the screen.

#### 4. BOOKKEEPING

Selecting this test will display a menu of four functions. Pushing the SELECT button momentarily will move an arrow on the screen. When the arrow points to the desired function, press either start button on the control panel to perform that function.

**DISPLAY SCORE COUNTS** — A table is shown with 20 categories of score values by thousands (K) and a count associated with each category. The count represents the number of plays in which the score at the end of the game fell into that category. In addition, a high score, low score, and average is shown along with the total number of plays on which the average is based. To clear the table, press either start button and return to the menu by holding down SELECT.

**DISPLAY TIME COUNTS** — Same as above except each category represents play times in seconds. The high, low, and average are given in minutes and seconds.

**DISPLAY ROUND COUNTS** — Same as above except each category represents the round in which the games ended.

Note: Each of these tables are independent of the others. Any table may be cleared without affecting the others in any way.

**RESET KRULL ELITE** — Pressing either start button will reset the Krull Elite table (all time high scores).

Note: There are two high score tables. The Daily Heroes high score table is reset on power up.

#### 5. SWITCH TEST

A colored square is displayed for each player button. Pressing a button causes the appropriate square to change color. For each coin mechanism, a digit is displayed (initially 0). Inserting a coin into a coin

## VII. BOOKKEEPING AND SELF TEST

chute will increment the appropriate value without affecting the coin meter.

Moving the MOVE joystick will display its direction of movement in the upper right corner of the screen. Moving the FIRE joystick will display its direction of movement directly under the MOVE joystick display.

### 6. SOUND TEST

After selecting this test a count will appear on the screen representing the various sounds that are produced by the game. There will be 28 different sounds produced and the screen count will repeat to 01. Pressing either Start button

will suppress all sound output and speed up the count so a particular sound can be sought out and checked.

Note: The count on the screen represents the binary signal code that will be sent to the A6 Sound board through the six sound input lines on the A6J1 connector. When executing the Sound Test sequence, there will be no sounds produced on counts 16 through 21 and 32 through 39. There are no sounds assigned to these numbers. These number assignments are subject to change.

## VIII. GENERAL INFORMATION

### A. PRINTED CIRCUIT BOARDS ARE DESIGNATED AS FOLLOWS:

- A1 Logic Board Assy.
- A3 Power Supply Assy.
- A6 Sound Board Assy.
- A8 Filter Board

### B. WIRE COLORS ARE SHOWN AS NUMBERS:

0 Black	5 Green
1 Brown	6 Blue
2 Red	7 Purple
3 Orange	8 Slate
4 Yellow	9 White

For example, 688 is a BLUE- SLATE-SLATE striped wire.

### C. FUSES

#### BOTTOM PANEL

F1	Primary Power	4 Amp SLO-BLO
F2	6.3 VAC	3 Amp SLO-BLO
F3	Monitor	2 Amp SLO-BLO
F4	9 VAC	10 Amp SLO-BLO
F5	15 VAC	1 Amp SLO-BLO

#### POWER SUPPLY ASSY. (A3)

F1 1	+5VDC Source	6 ¼ Amp SLO-BLO
F2 1	Sound Board Assy. +16VDC	2 Amp SLO-BLO
F3 1	Sound Board Assy. +12VDC	¼ Amp SLO-BLO
F3 2	Sound Board Assy. -12VDC	¼ Amp SLO-BLO
F4 1	Coin Meter +20VDC	1 Amp SLO-BLO

## VIII. GENERAL INFORMATION

### POWER SUPPLY SPECIFICATIONS

LOCATION	VOLTAGE	PROTECTION
Logic Board Assy.	+5VDC	Voltage adjustable. 6 Amps over-voltage protection and fused for over-current protection.
Sound Board	+16VDC	2 Amps fused for over-current protection. The reference for this circuit is a 1N4745A +16VDC Zener controlling the base of an emitter follower pass transistor.
Sound Board	+12VDC -12VDC	100 milliamps fused for over-current protection. The plus and minus 12 volts supplies are the 7812 and 7912 IC regulators respectively.
Coin Meter	+20VDC	Full wave rectified unfiltered voltage, fused for over-current protection.
Coin Chute Lights	+4.5VDC	Full wave rectified unfiltered voltage, fused for over-current protection.
Monitor and Marquee	100VAC or 115VAC, 60HZ	Isolated, fused AC voltage.

## IX. THEORY OF OPERATION

### INTRODUCTION

The character based graphics system designated GG-III has two main subdivisions. The first subdivision is the Central Processor Unit (CPU) which has three partitions:

- a. Microprocessors
- b. Memory
- c. Input and Output ports (I/O)

The Intel 8088 microprocessor is used and 32K bytes of memory is reserved for programming space and has 5 input ports and 5 output ports. The second subdivision is the video state machine which generates and controls the video signal to the monitor. The state machine has three partitions:

- a. System Clock (CLK)
- b. Foreground generator (FGND)
- c. Background generator (BGND)

The system clock is driven by a 20MHZ crystal, divided down for a 5MHZ dot clock.

All inputs and outputs including the video control and general purpose I/O are memory-mapped, (i.e. everything within the system can be addressed in a single segment of 64K addresses as memory).

The video control unit is divided into an "object-oriented" foreground driver and "character-oriented" background driver. The screen resolution is 256 pixels horizontally, and 240 lines vertically for both foreground and background. The CPU communicates with the foreground driver and background driver by writing data into the

designated memory areas in a certain format. The foreground is designed to display moving objects on the screen with a minimum overhead to the processor. The game programs will only have to specify the vertical and horizontal position and the object select number to the foreground driver. The background video supplements the foreground with relatively static figures on the screen. The CPU specifies all the character positions on the screen with desired "character" patterns.

A 5MHZ system clock drives a 9 bit horizontal dot counter and an 8 bit vertical line counter. The horizontal counter counts from 0 to 255 during active scan line and 256 to 317 during horizontal blanking time. When the horizontal counter reaches 317, the horizontal counter resets to 0. At the beginning of the horizontal blanking time (horizontal counter = 256) it increments the vertical counter. The vertical counter counts from 0 to 239 during active vertical scan time and 240 to 255 during vertical blanking time.

The battery backup system supports two battery RAM's that store all of the bookkeeping functions. The battery is maintained at a +3.6V reference by a trickle charge supplied on the logic board regulated by a current limiting resistor. If the AC power to the game is interrupted, the battery allows the RAM's to store the data contained in the Distributors table and the Options/Parameters screen.

## X. WIRING AND SCHEMATIC DIAGRAMS, PARTS LISTS

### TABLE OF CONTENTS

	<b>PAGE</b>
<b>LOGIC BOARD ASSY. (A1)</b>	
<b>COMPONENT LOCATION AND PARTS LIST</b> .....	<b>13</b>
<b>SCHEMATIC DIAGRAM (SHEET 1 OF 3)</b> .....	<b>16</b>
<b>SCHEMATIC DIAGRAM (SHEET 2 OF 3)</b> .....	<b>18</b>
<b>SCHEMATIC DIAGRAM (SHEET 3 OF 3)</b> .....	<b>21</b>
<b>POWER SUPPLY ASSY. (A3)</b>	
<b>COMPONENT LOCATION AND PARTS LIST</b> .....	<b>24</b>
<b>SCHEMATIC DIAGRAM</b> .....	<b>25</b>
<b>SOUND BOARD ASSY. (A6)</b>	
<b>COMPONENT LOCATION AND PARTS LIST</b> .....	<b>27</b>
<b>SCHEMATIC DIAGRAM</b> .....	<b>28</b>
<b>PRIMARY POWER/FILTER BOARD/ INTERCONNECTION DIAGRAM</b> .....	<b>30</b>

# X. WIRING AND SCHEMATIC DIAGRAMS, PARTS LISTS

## LOGIC BOARD ASSY. (A1), COMPONENT LOCATION

### LOGIC BOARD ASSY. (A1), PARTS LIST

#### MISCELLANEOUS ELECTRONIC COMPONENTS

REFERENCE	DESCRIPTION	PART NO.
Bat. 1	Battery, 3.6V	XO-458
C1-C16	Capacitor, 0.1 UF 50V AX. CR. +80%-20%	XO-230
C25	Capacitor, 100 UF, 25V EL-AX	XO-212
C26	Capacitor, 0.1 UF, 50V AX. CR. +80%-20%	XO-230
C27	Capacitor, 100 UF, 25V EL-AX	XO-212
C31-34	Capacitor, 0.1 UF, 50V AX. CR. +80%-20%	XO-230
C51	Capacitor, 100 PF, 100V CMD 5%	XO-198
C52	Capacitor, 0.1 UF, 100V CMD 5%	XO-196
C53	Capacitor, 10 UF, 25V AX. TANT. 10%	XO-127
ALL UNMARKED CAPACITORS	0.1 UF, 50V AX. CR. +80%-20%	XO-229
ALL POLARIZED UNMARKED CAPACITORS	10 UF, 25V AX. TANT. 10%	XO-127
D2	Diode, 1N4454	XO-275
D4	Diode, 1N4733A	XO-274
D81	Diode, 1N4148	XO-261
Q1	Transistor, MPS-U45	XO-306
Q2-Q4	Transistor, 2N6044	XO-120
Q81-Q87	Transistor, MPSA70	XO-309
R1-R16	Resistor, 470 OHM, 5% 1/4W	XO-35
R25	Resistor, 1K OHM, 5% 1/4W	XO-5
R31	Resistor, 10K OHM, 5% 1/4W	XO-18
R32-R34	Resistor, 1K OHM, 5% 1/4W	XO-5
R37, R38	Resistor, 330 OHM, 5% 1/4W	XO-34
R39	Resistor, 130 OHM, 5% 1/4W	XO-172
R40	Resistor, 270 OHM, 5% 1/4W	XO-68
R41, R42	Resistor, 510 OHM, 5% 1/4W	XO-25
R43	Resistor, 130 OHM, 5% 1/4W	XO-172
R44, R45	Resistor, 1K OHM, 5% 1/4W	XO-5
R51, R52	Resistor, 330 OHM, 5% 1/4W	XO-34
R53, R54, R56	Resistor, 1K OHM, 5% 1/4W	XO-5
R57, R58	Resistor, 560 OHM, 5% 1/4W	XO-36
R59-R61	Resistor, 1K OHM, 5% 1/4W	XO-5
R63, R64	Resistor, 1K OHM, 5% 1/4W	XO-5
R70	Resistor, 1K OHM, 5% 1/4W	XO-5
R73, R74	Resistor, 1K OHM, 5% 1/4W	XO-5
R76-R80	Resistor, 1K OHM, 5% 1/4W	XO-5
R81	Resistor, 820 OHM, 5% 1/4W	XO-174
R82	Resistor, 100 OHM, 5% 1/4W	XO-28
R83, R84	Resistor, 15 OHM, 5% 1/4W	XO-171
R85	Resistor, 180 OHM, 5% 1/4W	XO-24
R86, R87	Resistor, 15 OHM, 5% 1/4W	XO-171
R88	Resistor, 180 OHM, 5% 1/4W	XO-24
R89, R90	Resistor, 15 OHM, 5% 1/4W	XO-171
R91	Resistor, 180 OHM, 5% 1/4W	XO-24
R92	Resistor, 1K OHM, 5% 1/4W	XO-5
R93	Resistor, 2K OHM, 5% 1/4W	XO-14
R94	Resistor, 1K OHM, 5% 1/4W	XO-5
R95	Resistor, 470 OHM, 5% 1/4W	XO-35
R96	Resistor, 240 OHM, 5% 1/4W	XO-173
R97	Resistor, 2K OHM, 5% 1/4W	XO-14
R98	Resistor, 1K OHM, 5% 1/4W	XO-5
R99	Resistor, 470 OHM, 5% 1/4W	XO-35
R100	Resistor, 240 OHM, 5% 1/4W	XO-173
R101	Resistor, 2K OHM, 5% 1/4W	XO-14
R102	Resistor, 1K OHM, 5% 1/4W	XO-5
R103	Resistor, 470 OHM, 5% 1/4W	XO-35
R104	Resistor, 240 OHM, 5% 1/4W	XO-173
SIP 1, SIP 2, SIP 4	Resistor, Dip, 4.7K, 9 Pin	XO-492
SIP 71, SIP 72, SIP 73	Resistor, Dip, 1K, 9 Pin	XO-493
X-TAL 41	Crystal, 15 MHZ	XO-482
X-TAL 51	Crystal, 20 MHZ	XO-494
	Dip Switch	XO-505
	20 Pin Dip Socket	XO-491
	22 Pin Dip Socket	XO-467
	24 Pin Dip Socket	XO-529
	28 Pin Dip Socket	XO-536
	40 Pin Dip Socket	XO-530

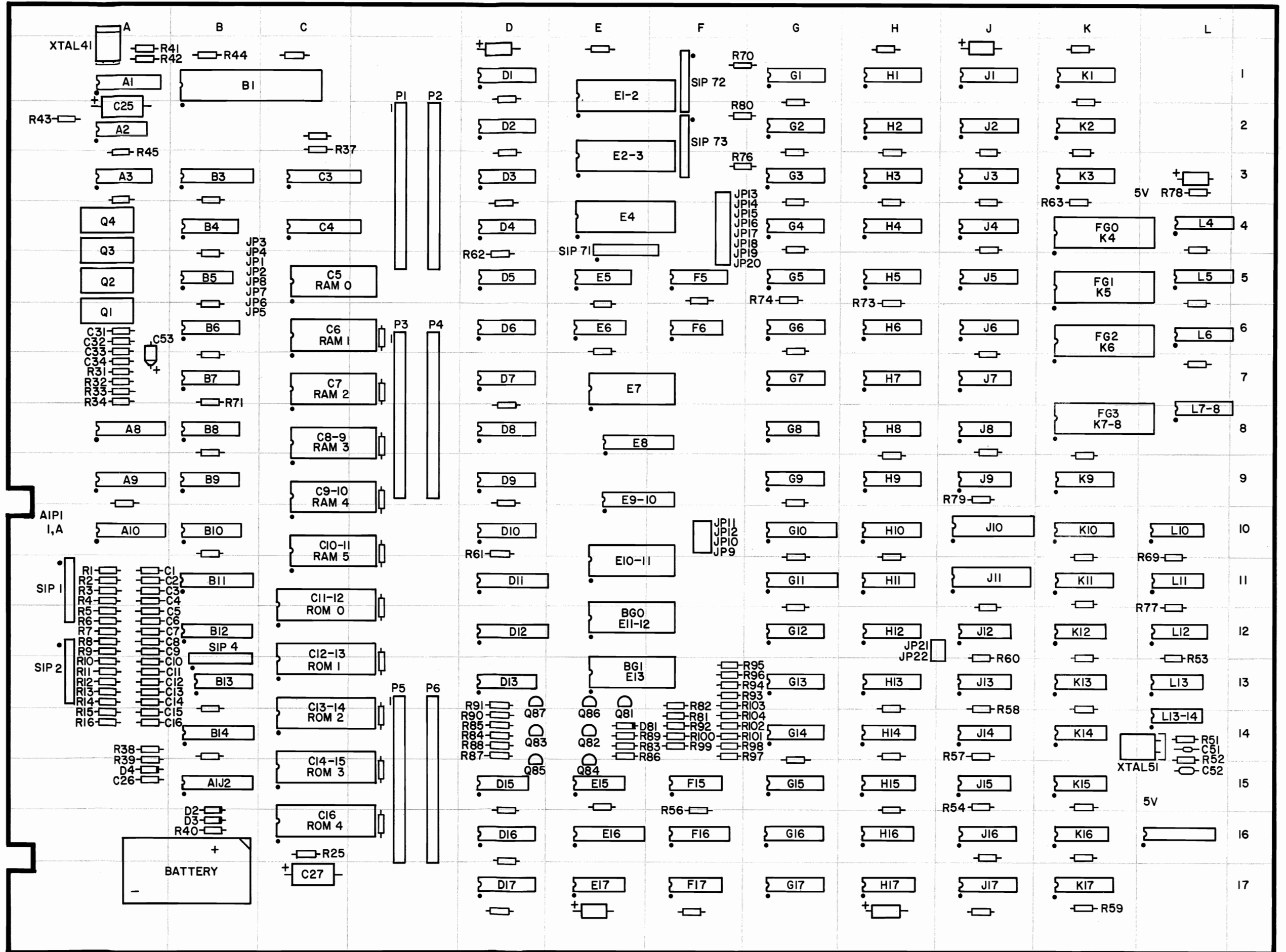

X. WIRING AND SCHEMATIC DIAGRAMS, PARTS LISTS

LOGIC BOARD ASSY. (A1), PARTS LIST (CONT.)

INTEGRATED CIRCUITS

REFERENCE	DESCRIPTION	PART NO.	REFERENCE	DESCRIPTION	PART NO.
A1	Logic Board Assy.	MA-456	G7	74157 Quad 2-input multiplexer	XO-114
A2	8284 CLK Driver	XO-478	G8	74LS74 Dual D-type flip flop	XO-434
A3	74LS02 Quad 2-input "NOR" gate	XO-428	G9	74LS157 Quad 2-input multiplexer	XO-124
A8, A9, A10	74161 Synchronous 4-bit counter	XO-192	G10	74LS245 Octal bus transceiver	XO-79
B1	74LS377 Octal "D" Flip Flop	XO-97	G11	74LS374 Octal D-type flip flop	XO-96
B3	8088 CPU	XO-490	G12	74LS157 Quad 2-input multiplexer	XO-390
B4	74LS373 Octal D-type flip flop	XO-445	G13, G14, G15	7489 64-bit RAM	XO-88
B5	74LS367 Hex 3-state buffer	XO-444	G16, G17	74LS174 Hex D flip flop	XO-442
B6	74LS08 Quad 2-input "AND" gate	XO-86	H1, H2, H3, H4	74S189 64-bit RAM	XO-89
B7	74HC138 Decoder/demultiplexer	XO-190	H5, H6	74S161 Synchronous presettable binary counter	XO-488
B8	74LS139 Dual 1 of 4 decoder	XO-419	H7, H8, H9, H10	74LS157 Quad 2-input multiplexer	XO-390
B9, B10	74LS138 1 of 8 decoder	XO-437	H11	74LS260 Dual 5-input "NOR" gate	XO-93
B11, B12, B14	74LS240 Octal Buffer/line driver	XO-91	H12	74LS298 Quad 2-port register	XO-118
C3	74LS373 Octal D-type flip flop	XO-445	H13	74LS157 Quad 2-input multiplexer	XO-390
C4	74LS245 Octal Bus transceiver	XO-79	H14	74LS00 Quad 2-input "NAND" gate	XO-427
C5	RAM 6 6116LP-4	XO-191	H15	74LS30 8 input "NAND" gate	XO-432
C6	RAM 1 6116LP-4	XO-485	H16, H17	74LS86 Dual 2-input exclusive "OR" gate	XO-435
C7	ROM A 2732A 4K x 8 EPROM	XO-489	J1, J2, J3	74S189 64-bit RAM	XO-89
C9-C10	ROM B 2732A 4K x 8 EPROM	XO-489	J4, J5, J6	74LS04 Hex inverter	XO-418
C11-12	ROM C 2764 8K x 8 EPROM	XO-489	J7	74LS32 Quad 2-input "OR" gate	XO-433
C12-13	ROM 1 2764 8K x 8 EPROM	XO-489	J8	7408 Quad 2-input "AND" gate	XO-404
C13-14	ROM 2 2764 8K x 8 EPROM	XO-489	J9	93422 256 x 2 bipolar RAM	XO-100
C14-15	ROM 3 2764 8K x 8 EPROM	XO-489	J10, J11	74LS02 Quad 2-input "NOR" gate	XO-428
C16	74LS139 Dual 1 of 4 Decoder	XO-419	J12	74LS74 Dual D-type flip flop	XO-434
D1	74157 Quad 2-input multiplexer	XO-114	J13	7407 Hex buffer/driver	XO-384
D2, D3, D4, D5, D6, D7, D8, D9, D10	74LS374 Octal D-type flip flop	XO-96	J14	74LS30 8 input "NAND" gate	XO-432
D11	74LS244 Octal buffer/line driver	XO-117	J15	74S161 Synchronous presettable binary counter	XO-488
D12	74LS157 Quad 2-input multiplexer	XO-390	J16, J17	74LS379 Quad D-type flip flop	XO-98
D13	74LS86 Quad 2-input exclusive "OR" gate	XO-435	K4	FG0 2764-3 8K x 8 EPROM	XO-489
D16	74LS283 4-bit binary full adder	XO-95	K5	FG1 2764-3 8K x 8 EPROM	XO-489
D17	74S161 Synchronous presettable binary counter	XO-488	K6	FG2 2764-3 8K x 8 EPROM	XO-489
E1-2, E2-3, E4	93419 64 x 9 bipolar RAM	XO-99	K7-8	FG3 2764-3 8K x 8 EPROM	XO-489
E5	74LS283 4-bit binary full adder	XO-95	K9, K10, K11	74LS157 Quad 2-input multiplexer	XO-390
E6	74LS30 8-input "NAND" gate	XO-432	K12	74LS260 Dual 5-input "NOR" gate	XO-93
E7	4801 1K x 8 RAM	XO-193	K13	74LS32 Quad 2-input "OR" gate	XO-433
E8, E9-10	74LS245 Octal Bus Transceiver	XO-79	K14	74LS08 Quad 2-input "AND" gate	XO-86
E10-11	4801 1K x 8 RAM	XO-193	K15	74S04 Hex inverter	XO-400
E11-12	2128 (BG9) RAM	XO-195	K16	74LS20 Dual 4-input "NAND" gate	XO-430
E13	2128 (BG1) RAM	XO-195	K17	74S161 Synchronous presettable binary counter	XO-488
E15	74LS86 Quad 2-input exclusive "OR" gate	XO-435	L4, L5, L6, L7-8	74LS166 8-bit shift register	XO-391
E16	74LS273 8-bit register	XO-94	L10	74LS74 Dual flip flop	XO-434
E17	74LS20 Dual 4-input "NAND" gate	XO-430	L11	74LS20 Dual 4-input "NAND" gate	XO-430
F5	74LS283 4-bit binary full adder	XO-95	L12	74S161 Synchronous presettable binary counter	XO-440
F6	74LS32 Quad 2-input "OR" gate	XO-433	L13	74S74 Dual D-type pos. edge trig. flip flop (T. 1. only)	XO-87
F15	74LS04 Hex inverter	XO-418	L13-14	74S04 Hex inverter	XO-400
F16	74S161 Synchronous presettable binary counter	XO-488			
F17	74LS86 Quad 2-input exclusive "OR" gate	XO-435			
G1, G2, G3, G4, G5, G6	74LS157 Quad 2-input multiplexer	XO-390			
	74S161 Synchronous presettable binary counter	XO-440			

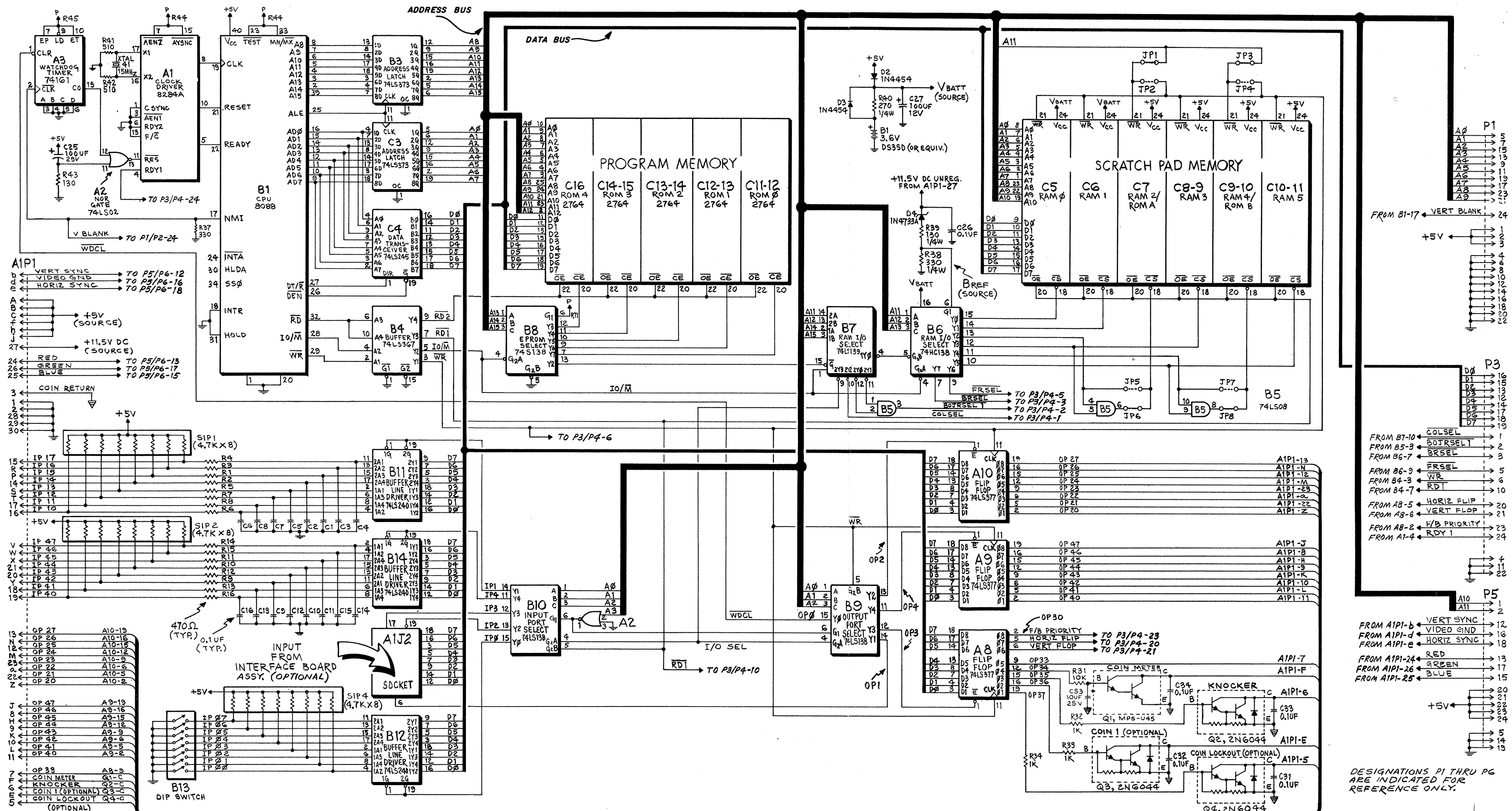

X. WIRING AND SCHEMATIC DIAGRAMS, PARTS LISTS

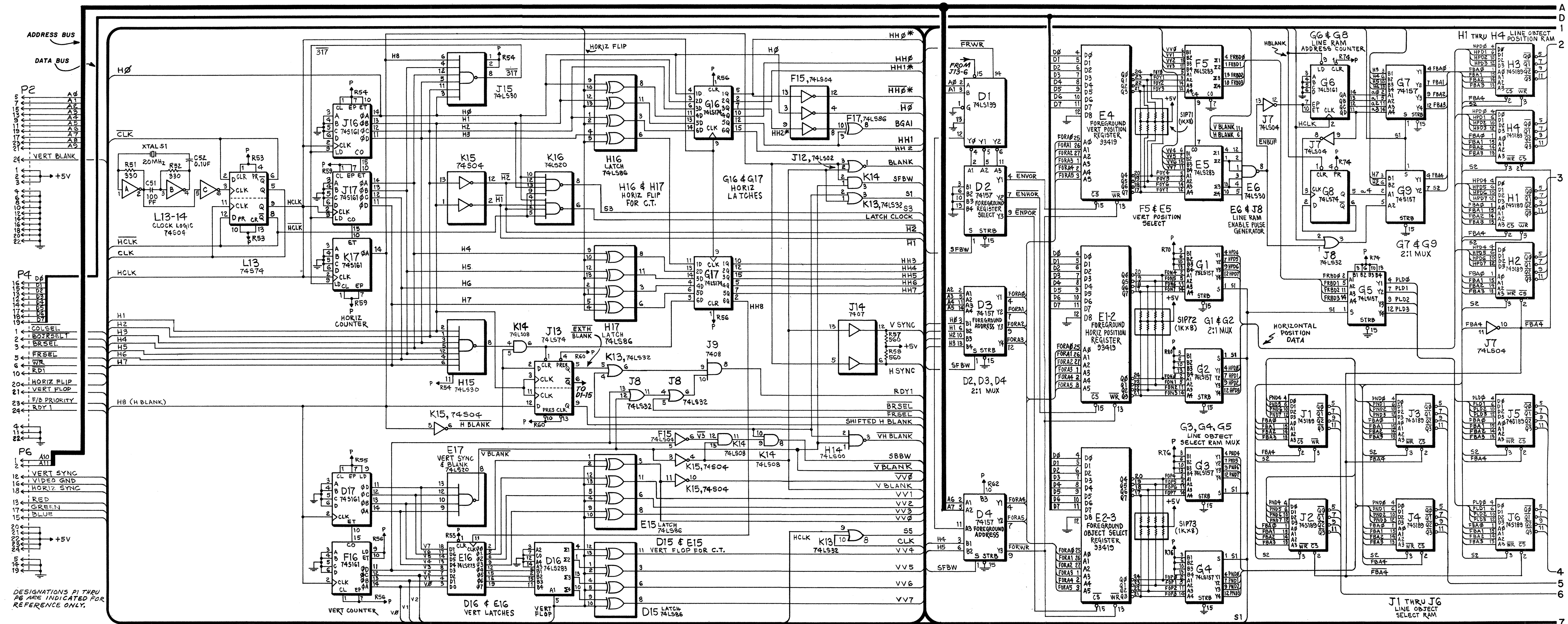

LOGIC BOARD ASSY. (A1), SCHEMATIC DIAGRAM, SHEET 2 OF 3



X. WIRING AND SCHEMATIC DIAGRAMS, PARTS LISTS

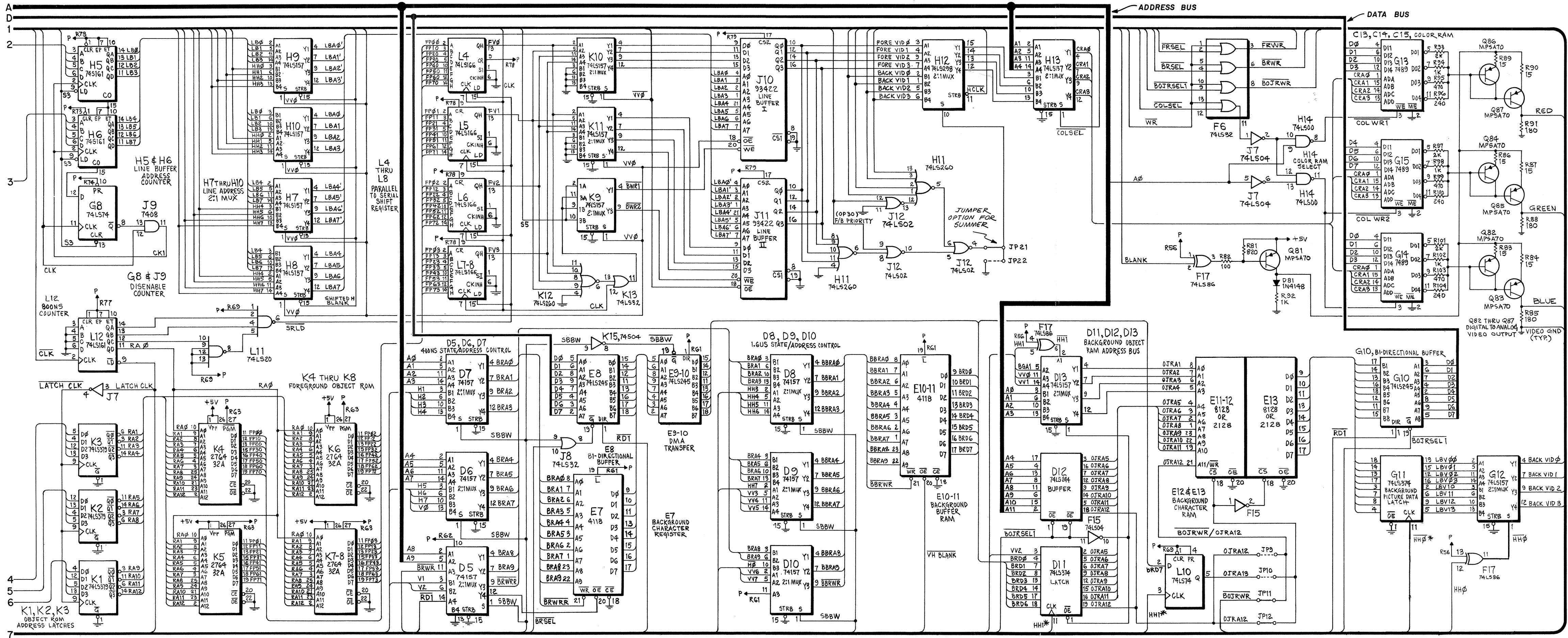

LOGIC BOARD ASSY. (A1), SCHEMATIC DIAGRAM, SHEET 3 OF 3

# X. WIRING AND SCHEMATIC DIAGRAMS, PARTS LISTS

## POWER SUPPLY ASSY. (A3), COMPONENT LOCATION

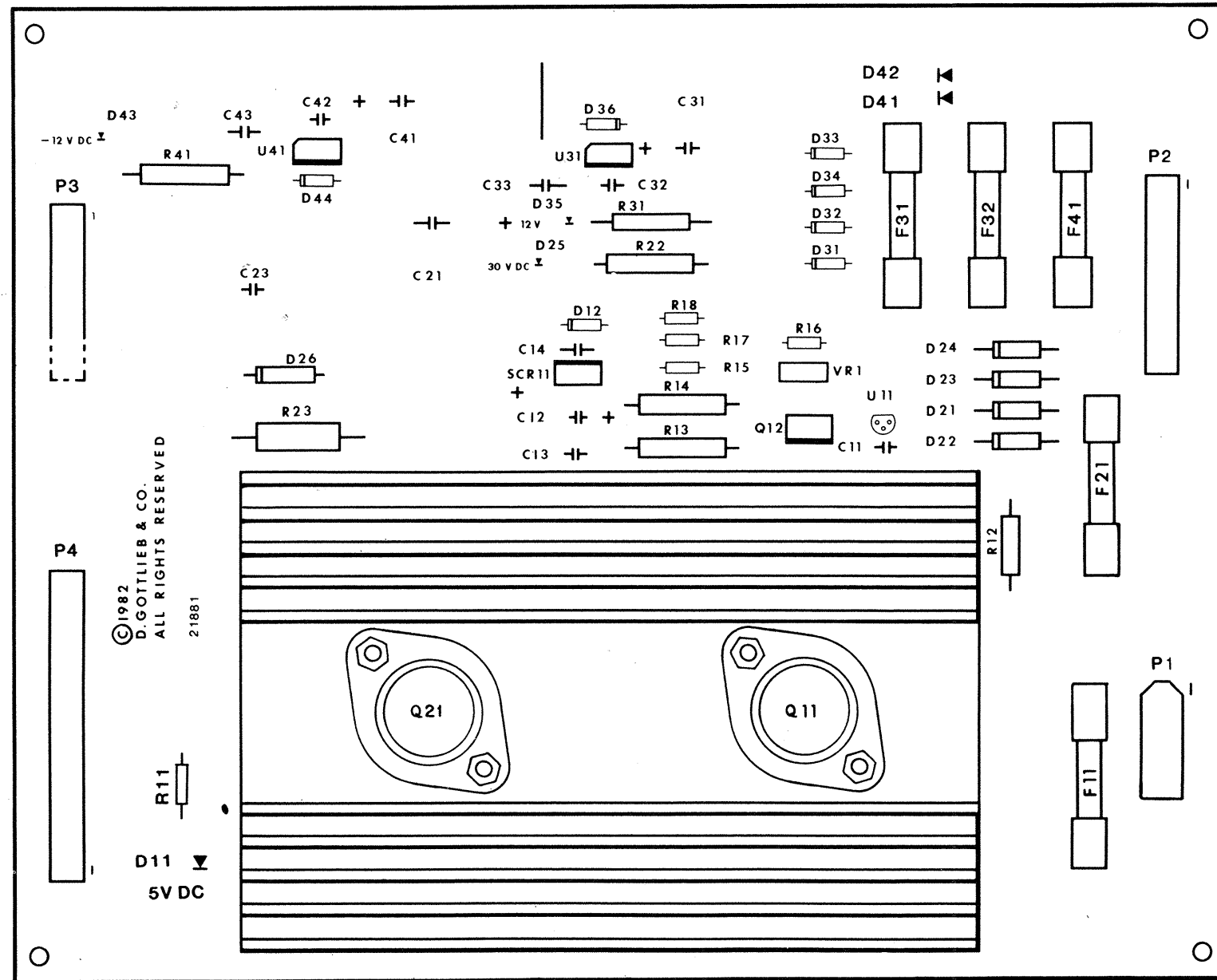

## POWER SUPPLY ASSY. (A3), PARTS LIST

REFERENCE	DESCRIPTION	PART NO.	REFERENCE	DESCRIPTION	PART NO.
C11, C32, C42	Capacitor, .01 mfd., 50V	MA-492	P2	Connector, 10 PIN	XO-531
C12	Capacitor, 100UF, 16V	XO-229	P3	Connector, 7 PIN	XO-526
C13, C23	Capacitor, 0.1UF, 100V	XO-235	P4	Connector, 16 PIN	XO-372
C14, C33, C43	Capacitor, 0.2UF, 16V	XO-234	Q11	Transistor, PNP, 2N5879	XO-323
C21	Capacitor, 2200UF, 75V	XO-205	Q12	Transistor, NPN, TIP31B	XO-641
C31, C41	Capacitor, 470UF, 35V	XO-132	Q21	Transistor, NPN, 2N3055	XO-301
D11, D25	Diode, Light Emitting MV-5752	XO-284	R11	Resistor, 470 OHM, 5% 1/2W	XO-55
D35, D43	Diode, Zener, 5.6V, 5%, 1W, 1N4734A	XO-270	R12	Resistor, 100 OHM, 5% 1W	XO-137
D12	Diode, Zener, 5.6V, 5%, 1W, 1N4734A	XO-255	R13, R14	Resistor, 12 OHM, 5% 2W	XO-138
D21-D24	Diode, 1N5401	XO-263	R15	Resistor, 200 OHM, 5% 1/4W	XO-143
D26	Diode, Zener, 16V, 5%, 1W, 1N4745A	XO-620	R16	Resistor, 180 OHM, 5% 1/4W	XO-24
D31-D34, D36	Diode, 1N4004	XO-254	R17	Resistor, 100 OHM, 5% 1/4W	XO-28
D41, D42, D44	Fuse, 6 1/4 AMP SLO-BLO	EL-8	R18	Resistor, 20 OHM, 5% 1/4W	XO-29
F11	Fuse, 2 AMP SLO-BLO	EL-7	R22	Resistor, 1.8KOHM, 5% 2W	XO-135
F21	Fuse, 1 AMP SLO-BLO	EL-5	R23	Resistor, 1KOHM, 5% 2W	XO-627
F31, F32	Fuse, 1/4 AMP SLO-BLO	EL-6	R31, R41	Resistor, 750 OHM, 5% 1W	XO-136
F41	Fuse, 1 AMP SLO-BLO	PS-87	SCR11	Silicon Controlled Rectifier	XO-131
P1	Connector, 4 PIN		U11	Diode, Programmable Zener TL431	XO-272
			U31	Voltage Regulator +12V, LM 340T	XO-473
			U41	Voltage Regulator -12V, LM 320	XO-130
			VR1	Potentiometer, 100 OHM	XO-134

# X. WIRING AND SCHEMATIC DIAGRAMS, PARTS LISTS

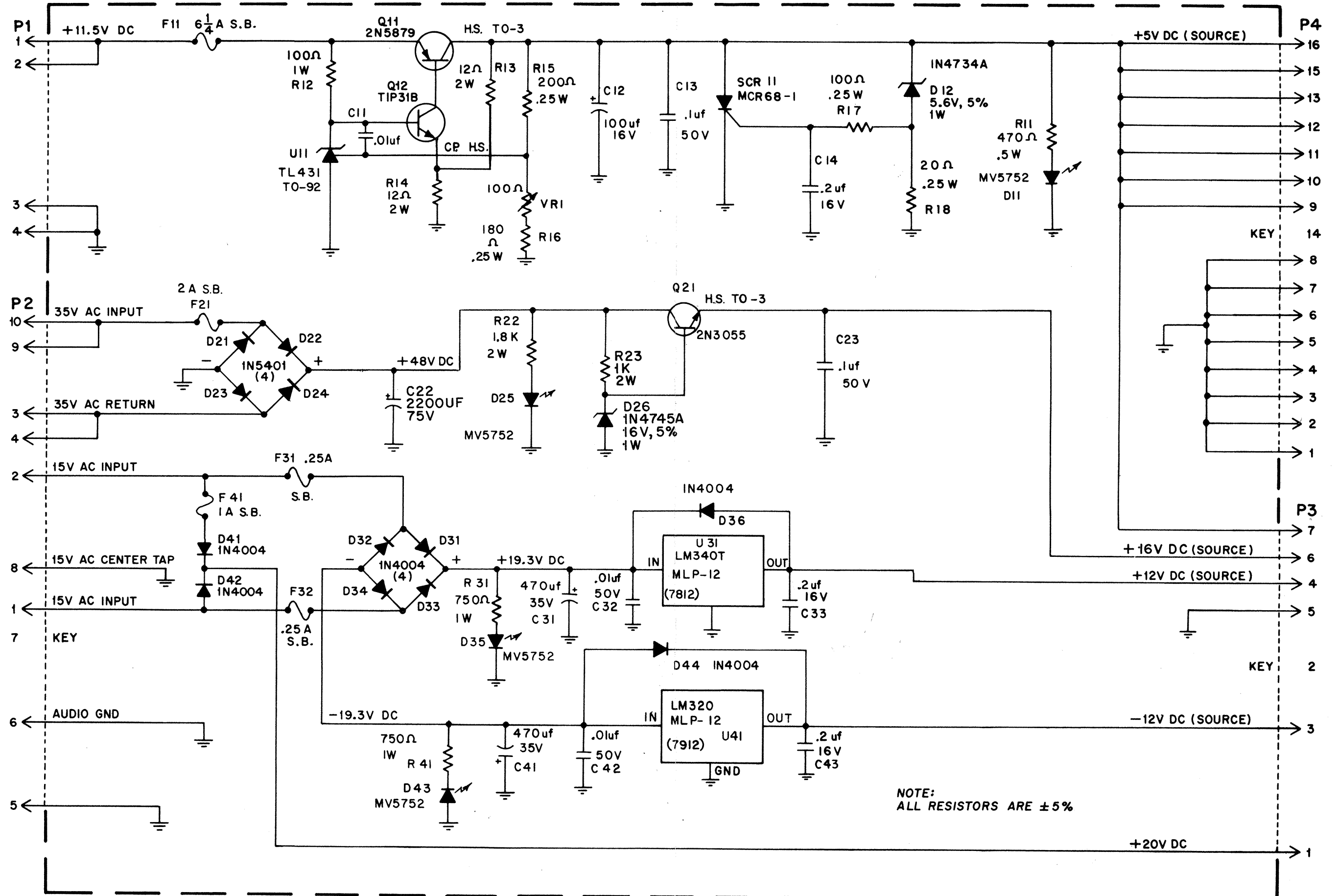

## POWER SUPPLY ASSY. (A3), SCHEMATIC DIAGRAM

X. WIRING AND SCHEMATIC DIAGRAMS, PARTS LISTS

X. WIRING AND SCHEMATIC DIAGRAMS, PARTS LISTS

SOUND BOARD ASSY. (A6), COMPONENT LOCATION

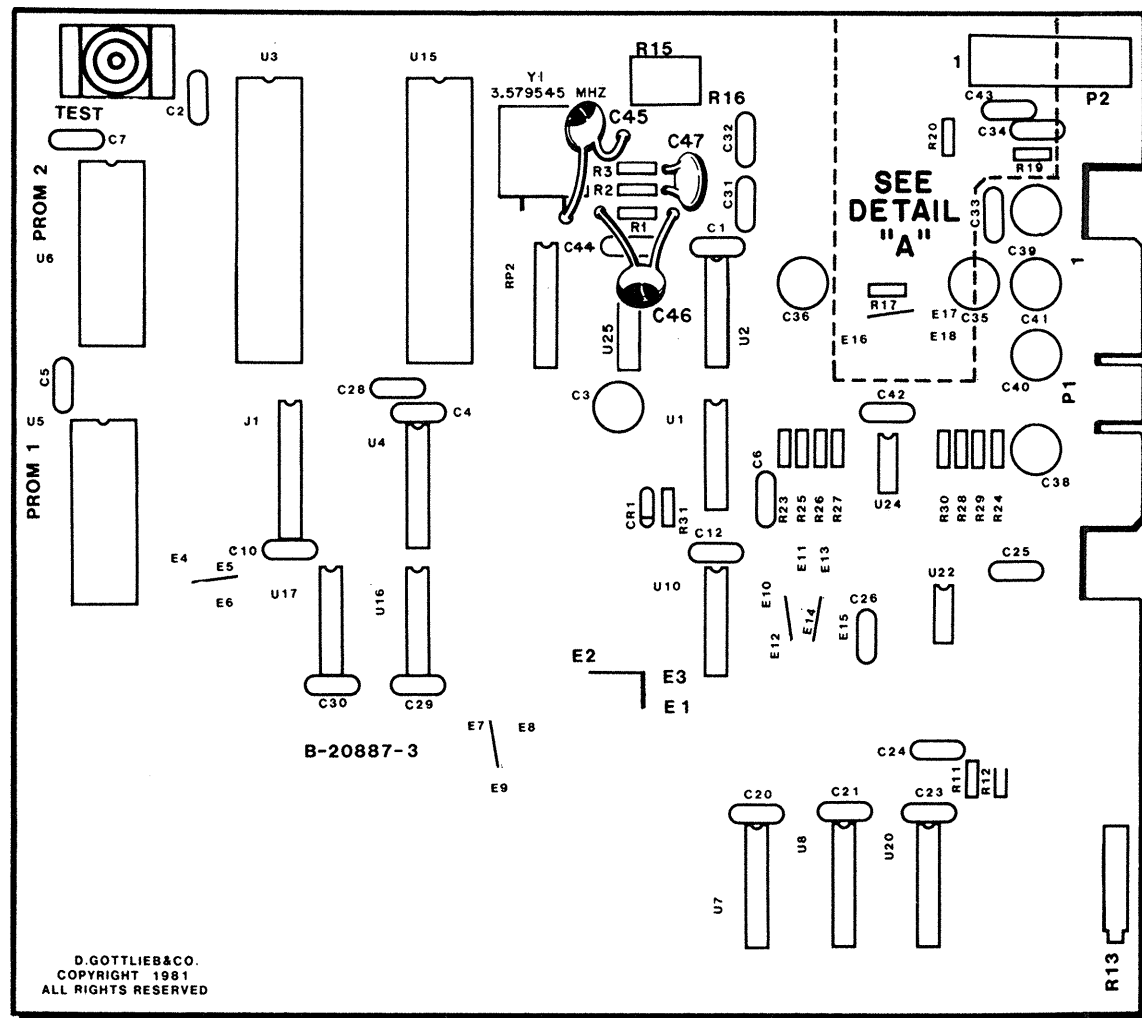

SOUND BOARD ASSY. (A6), PARTS LIST

REFERENCE	DESCRIPTION	PART NO.	REFERENCE	DESCRIPTION	PART NO.
C1, C2	Sound Board Assembly	MA-487	RP2	Resistor, DIP	XO-168
C4-C7, C10	Capacitor, 0.1UF, 25V	XO-248	SW1	Switch, Momentary Pushbutton	XO-515
C12, C20, C21			U1	IC, 7414	XO-397
C23, C25, C26			U2	IC, SN74LS74N	XO-434
C28, C29, C30			U3	CPU, R6502-13	XO-360
C33, C42, C44			U4	IC, SN74LS138N	XO-437
C31, C32	Capacitor, .047UF, 25V	XO-222	U5-U6	EPROM, 2732	XO-485
C37	Capacitor, 4.7UF, 35V	XO-291	U7	IC, SN74LS75	XO-394
C38, C39, C41	Capacitor, 47UF, 50V	XO-210	U10	IC, SN74LS02N	XO-428
C24	Capacitor, 100PF	XO-223	U15	IC, SN74LS21B	XO-361
C36	Capacitor, 470UF, 35V	XO-284	U16	IC, SN74LS04N	XO-418
C45, C46	Capacitor, 33PF	XO-277	U17	IC, SN74LS30N	XO-432
C47	Capacitor, .01UF, 100V	XO-202	U20	Converter, PMI, 1408A-6P	XO-416
CR1	Diode, IN4148	XO-261	U22	IC, LM741CP	XO-393
R1, R11, R12	Resistor, 5.6K ohm, 5%, 1/4W	XO-19	U24	IC, Dual Comparator, LM193	XO-396
R2, R3	Resistor, 2K ohm, 5%, 1/4W	XO-14	U25	Inverter, 7404	XO-402
R13	Potentiometer, 10K ohm	XO-108	Y1	Crystal, 3.579545MHZ	XO-456
R15	Potentiometer, 10K ohm	XO-109			
R23-R30	Resistor, 10K ohm, 5%, 1/4W	XO-18			
R31	Resistor, 68K ohm, 5%, 1/4W	XO-189			

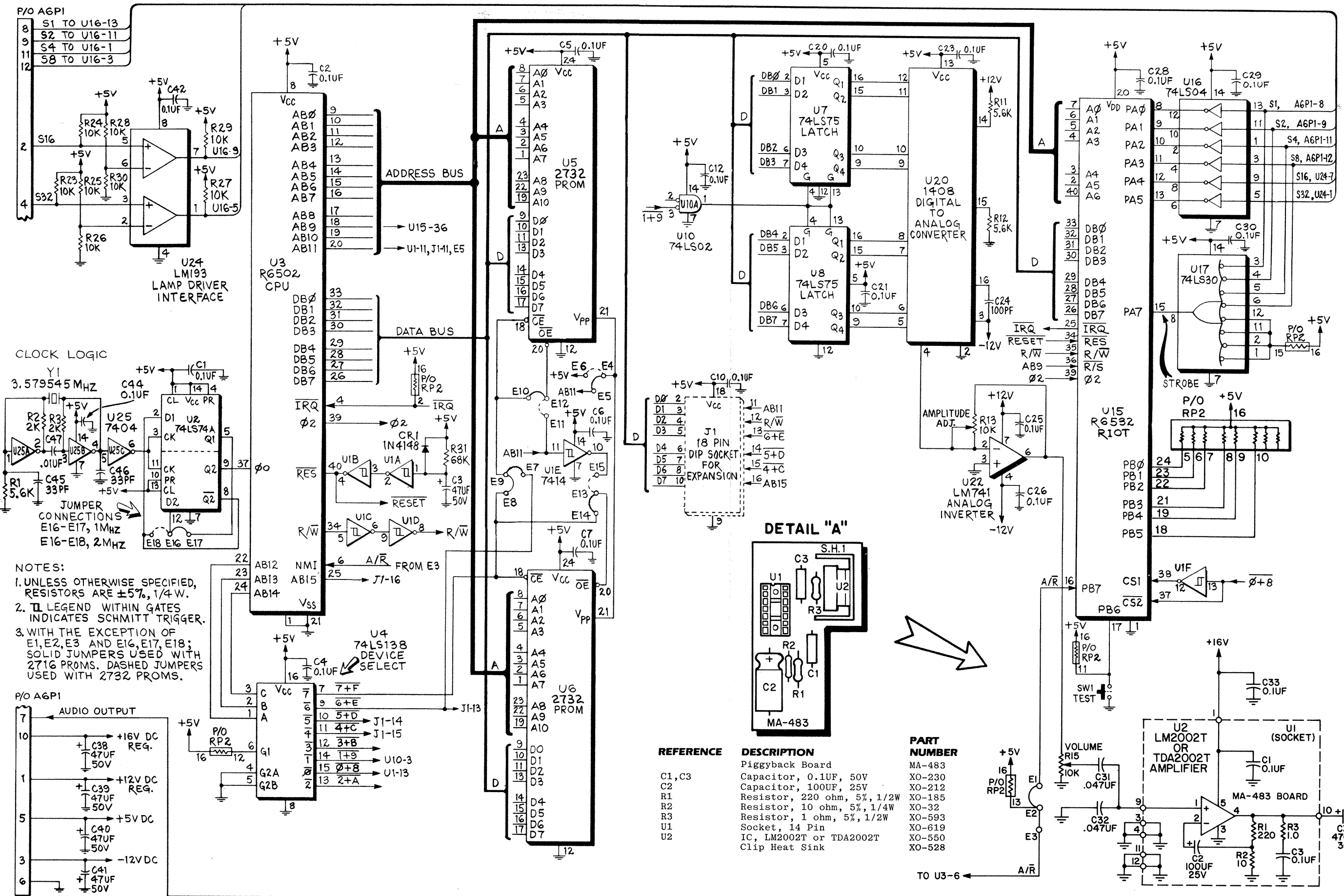

REFERENCE	DESCRIPTION	PART NUMBER
C1, C3	Piggyback Board	MA-483
C2	Capacitor, 0.1UF, 50V	XO-230
R1	Capacitor, 100UF, 25V	XO-212
R2	Resistor, 220 ohm, 5%, 1/2W	XO-185
R3	Resistor, 10 ohm, 5%, 1/4W	XO-32
U1	Resistor, 1 ohm, 5%, 1/2W	XO-593
U2	IC, LM2002T or TDA2002T	XO-619
	Clip Heat Sink	XO-550
		XO-528

SOUND BOARD ASSY. (A6), SCHEMATIC DIAGRAM

**X. WIRING AND SCHEMATIC DIAGRAMS, PARTS LISTS**

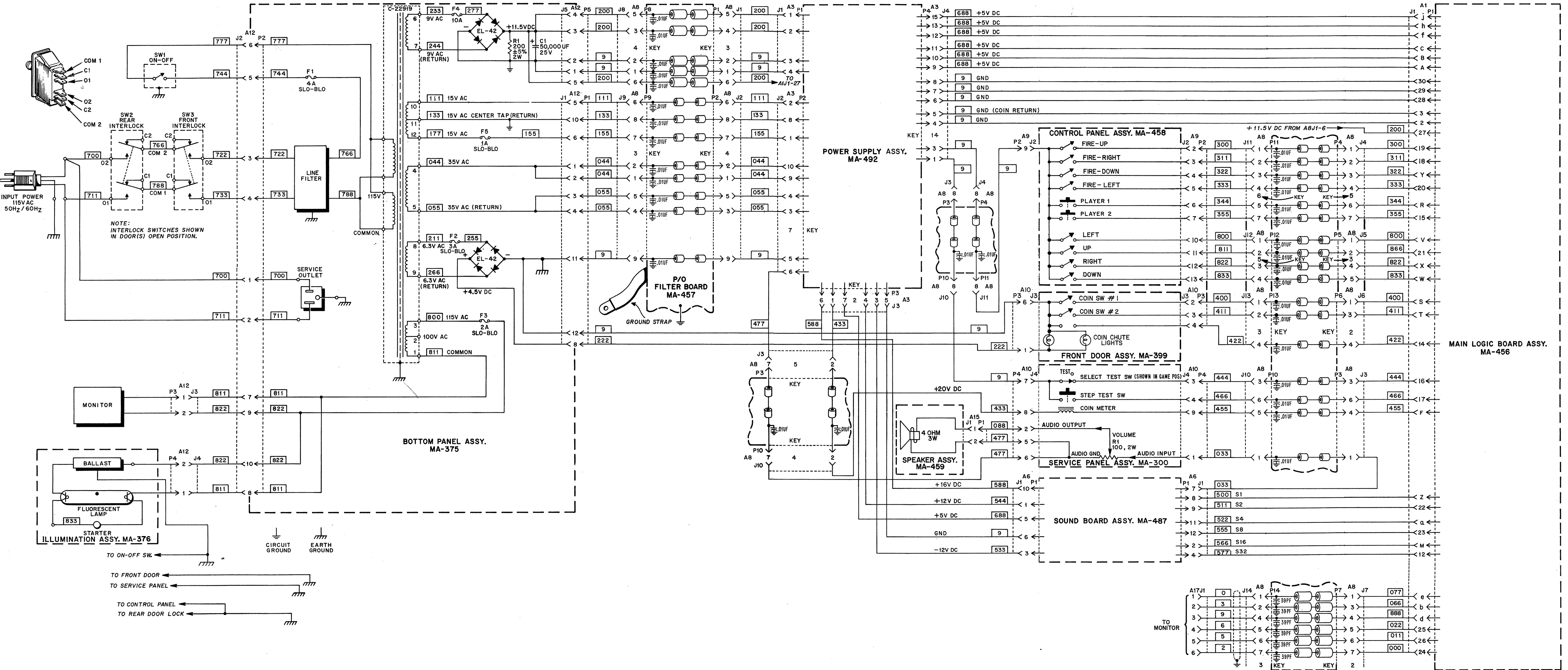

**PRIMARY POWER/FILTER BOARD/INTERCONNECTION DIAGRAM**

# XI. PARTS INFORMATION

## TABLE OF CONTENTS

	<b>PAGE</b>
<b>SPEAKER/MARQUEE ASSY. ....</b>	<b>34</b>
<b>ILLUMINATION ASSY. ....</b>	<b>34</b>
<b>CONTROL PANEL ASSY. ....</b>	<b>35</b>
<b>SERVICE PANEL ASSY. ....</b>	<b>36</b>
<b>BOTTOM PANEL ASSY. ....</b>	<b>37</b>
<b>CABINET PARTS .....</b>	<b>38</b>
<b>CABINET PARTS .....</b>	<b>39</b>

# XI. PARTS INFORMATION

## SPEAKER/MARQUEE ASSY. AND ILLUMINATION ASSY.

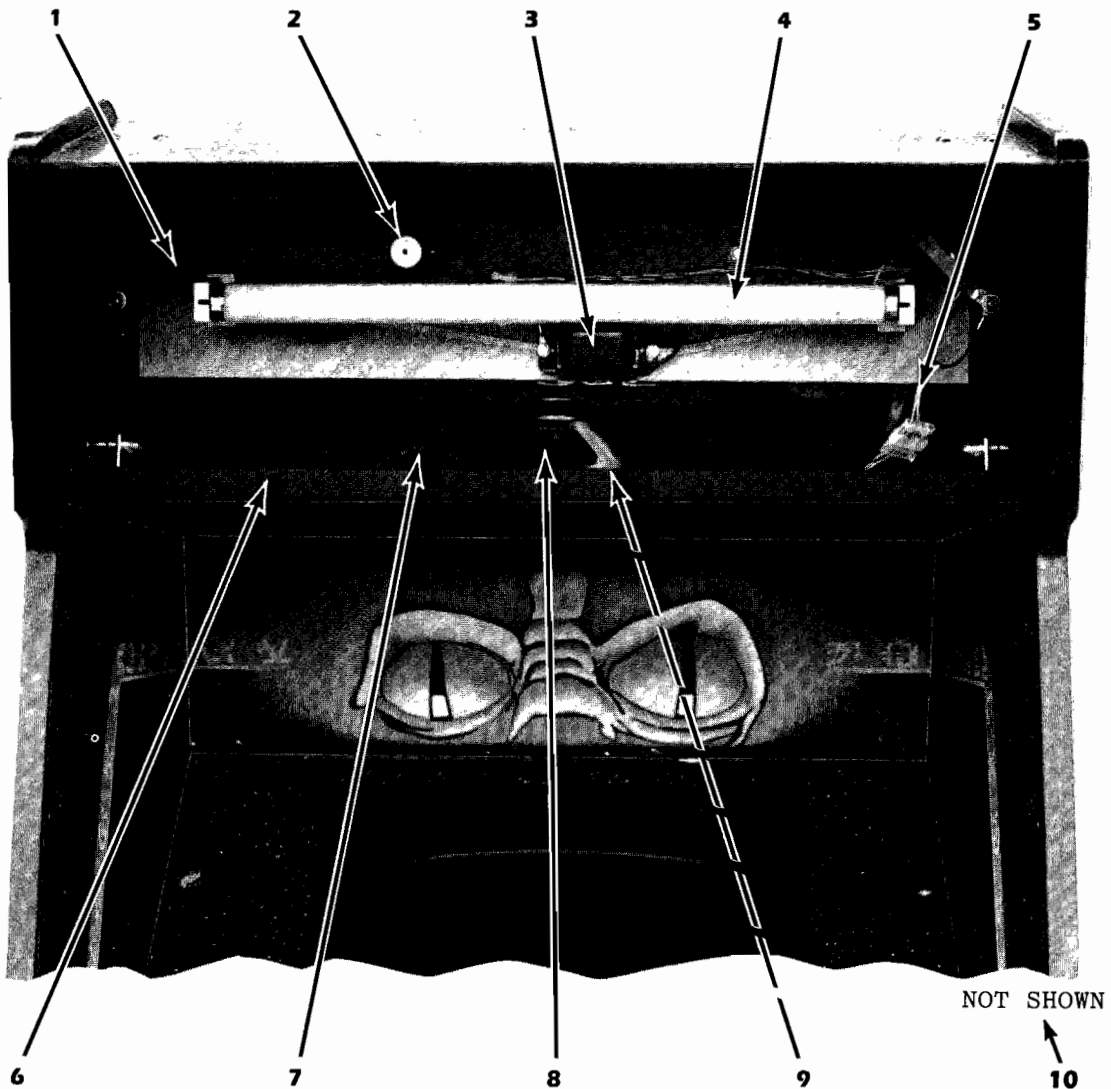

ITEM	DESCRIPTION	PART NO.
1.	Illumination Assy.	MA-376
2.	Starter	EL-69
3.	Ballast (60 HZ)	EL-70
4.	Lamp, Fluorescent	LA-4
5.	Cable Assy.	MA-364
6.	Speaker Assy.	MA-459
7.	Cable Assy.	MA-318
8.	Speaker	EL-93
9.	Speaker Grill	B-20931
10.	Marquee, Lexan (Screen)	A-23044

# XI. PARTS INFORMATION

## CONTROL PANEL ASSY.

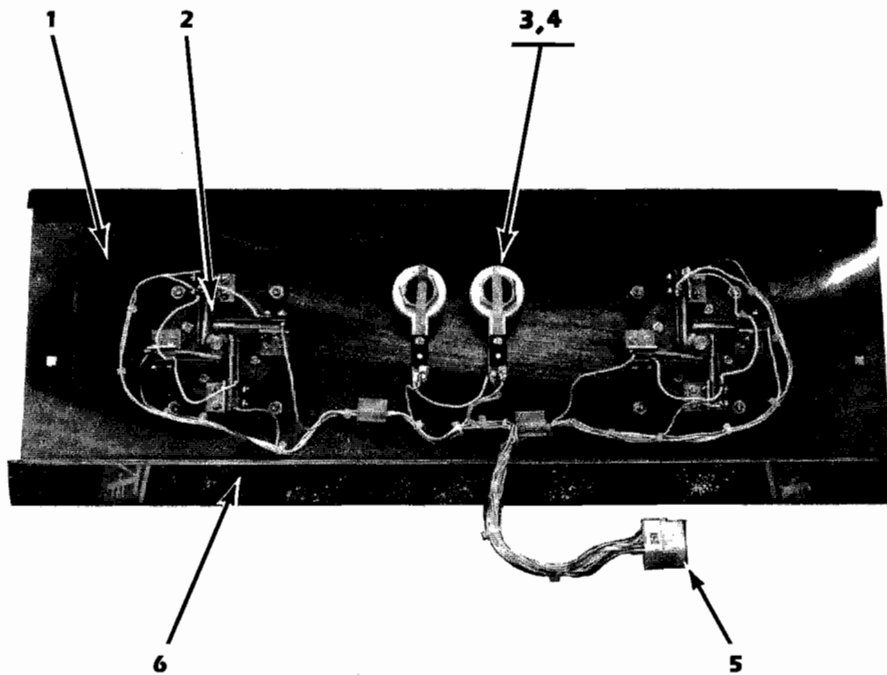

ITEM	DESCRIPTION	PART NO.
1.	Control Panel Assy.	MA-458
2.	Joystick (2)	C-22917
3.	Short Button (2)	A-21970
4.	Button Holder and Switch (2)	A-21971
5.	Cable Assy.	MA-464
6.	Lexan Overlay	A-23045

# XI. PARTS INFORMATION

## SERVICE PANEL ASSY.

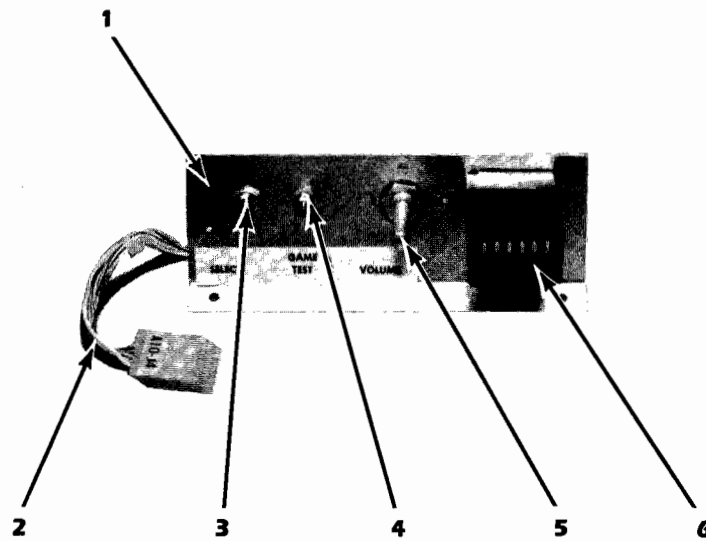

ITEM	DESCRIPTION	PART NO.
1.	Service Panel Assy.	MA-300
2.	Cable Assy.	MA-316
3.	Switch (Push Button)	EL-57
4.	Switch (Toggle)	EL-85
5.	Volume Control	XO-104
6.	Coin Meter	EL-84



# XI. PARTS INFORMATION

## BOTTOM PANEL ASSY.

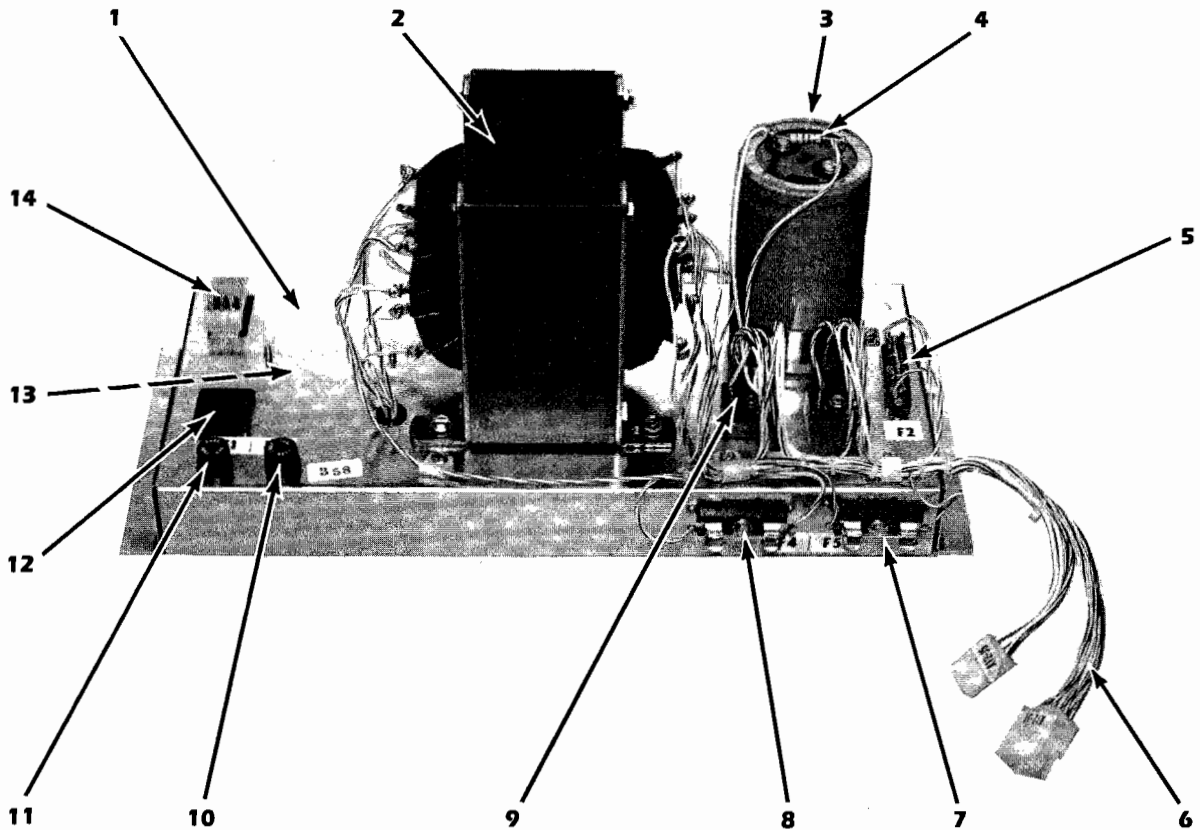

ITEM	DESCRIPTION	PART NO.
1.	Bottom Panel Assy.	MA-375
2.	Transformer	C-22919
3.	Capacitor, 50, 000UF, 25V	XO-141
4.	Resistor, 200 OHM, 5%, 2W	XO-142
5.	Fuse, 3 AMP, SLO-BLO	EL-9
6.	Cable Assy. (Secondary)	MA-476
7.	Fuse, 1 AMP, SLO-BLO	EL-6
8.	Fuse, 10 AMP	EL-23
9.	Bridge Rectifier (2)	EL-42
10.	Fuse, 2 AMP, SLO-BLO	EL-7
11.	Fuse, 4 AMP, SLO-BLO	EL-33
12.	Service Outlet	A-18133
13.	Line Filter	EL-50
14.	Cable Assy. (Primary)	MA-363

# XI. PARTS INFORMATION

## CABINET PARTS

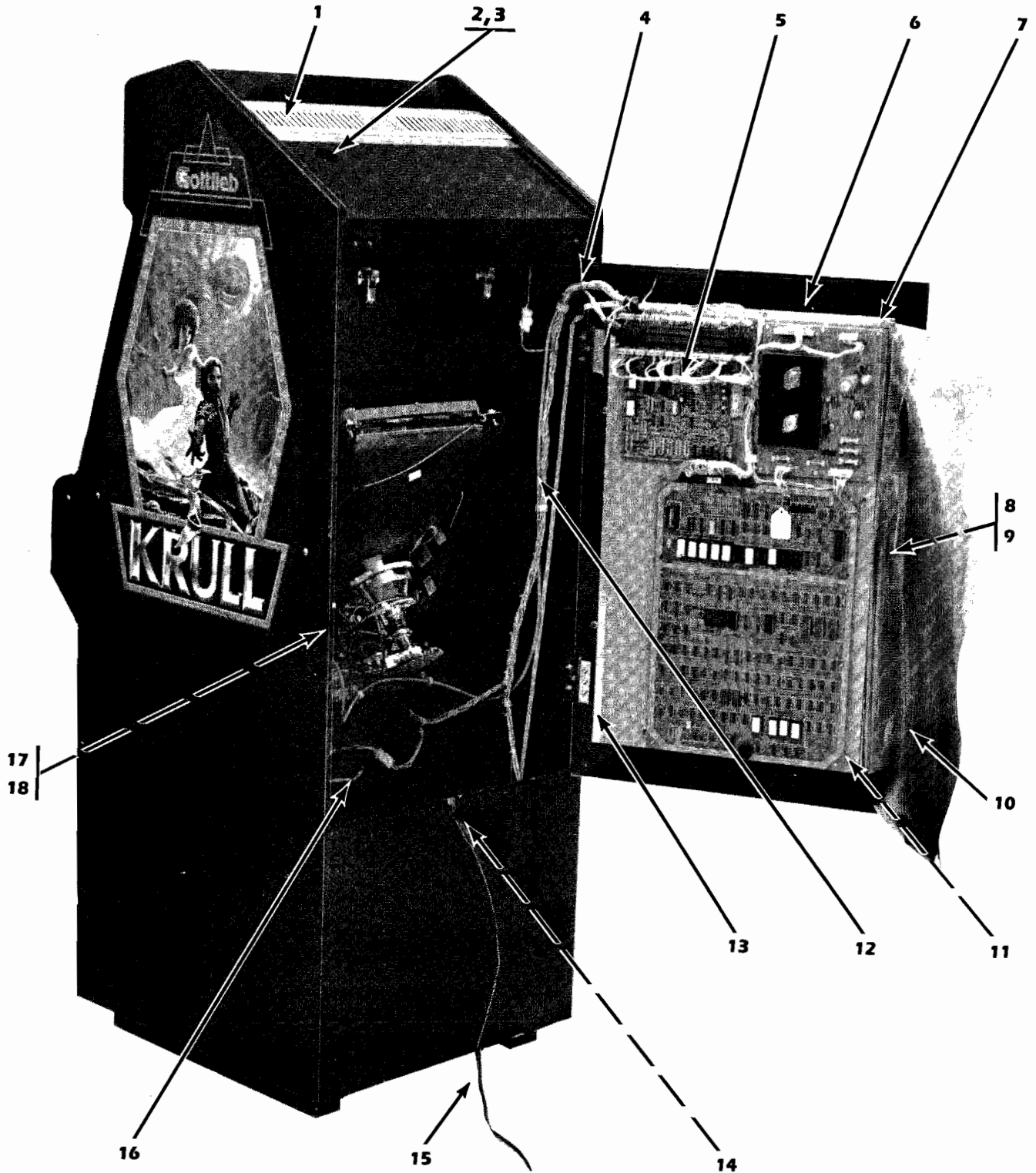

ITEM	DESCRIPTION	PART NO.	ITEM	DESCRIPTION	PART NO.
1.	Vent Channel (2)	D-21754	10.	Shield, Top	D-22632
2.	On-Off Switch	EL-56	11.	Shield, Bottom	C-22633
3.	Switch Plate	A-22396	12.	Monitor Cable	A-22620
4.	Cable Assy. Master Electronics	MA-466	13.	Clip Bracket, Shield	B-22631
5.	Interconnect Cable	MA-465	14.	Cover Plate, Line Cord	A-21955
6.	Back Door	D-23073-3	15.	Line Cord	B-15357
7.	Master Electronic Board	MA-1155	16.	Cable Assy. High Voltage	MA-360
8.	Rear Door Lock	MH-0	17.	Interlock Switch	EL-66
9.	Anchor Plate, Lock	MH-1	18.	Cover, Interlock Switch	A-21888

# XI. PARTS INFORMATION

## CABINET PARTS

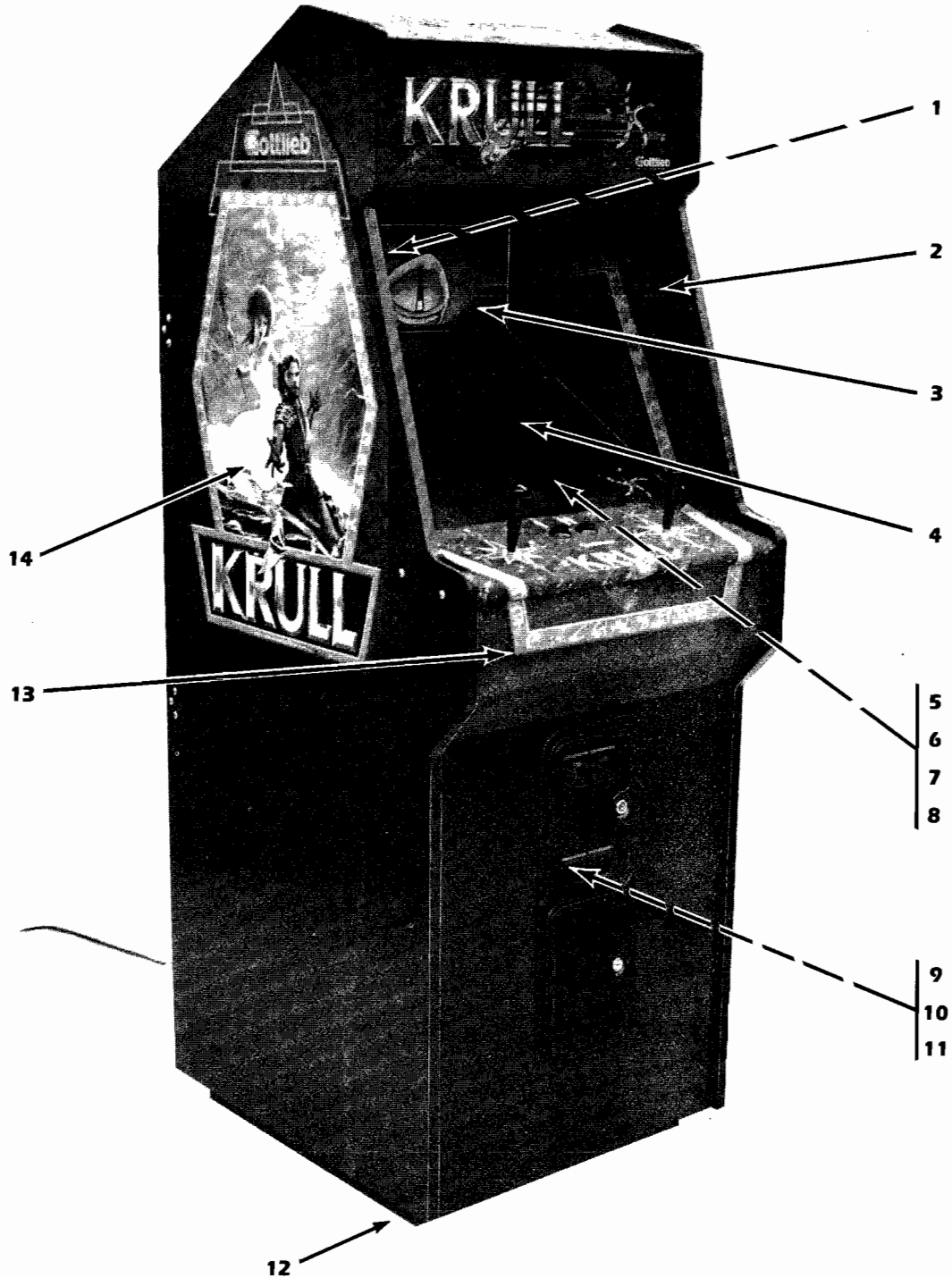

ITEM	DESCRIPTION	PART NO.	ITEM	DESCRIPTION	PART NO.
1.	Left Side CRT Decal	A-23068	8.	Monitor	C-22462-3
2.	Right Side CRT Decal	A-23069	9.	Cable Assy. Front Door	MA-369
3.	Rear Side CRT Decal	A-23070	10.	Interlock Switch	EL-66
4.	Top Glass	A-22464	11.	Cover, Interlock Switch	A-21888
5.	CRT Frame	A-23042	12.	3" Leg Adjuster (2)	MH-21
6.	Monitor Filter Glass	C-22849-1	13.	Lexan Overlay (Screen)	A-23043
7.	Monitor Mask	D-22463	14.	Side Decal (Left or Right)	D-21346

# SERVICE NOTES



# WELLS-GARDNER ELECTRONICS CORPORATION

---

## 19" IN LINE COLOR MONITORS

### MODELS

19K4901  
19K4906

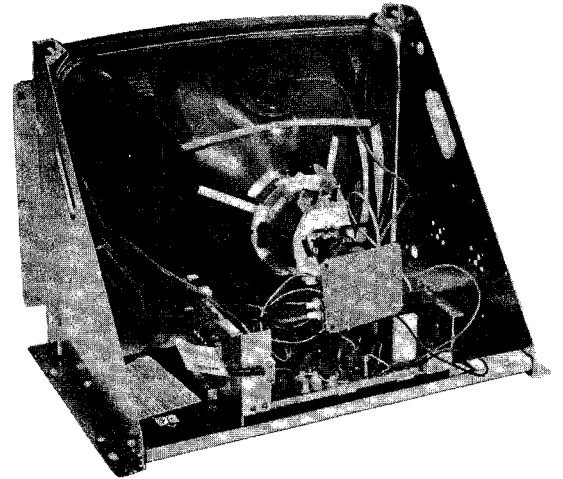
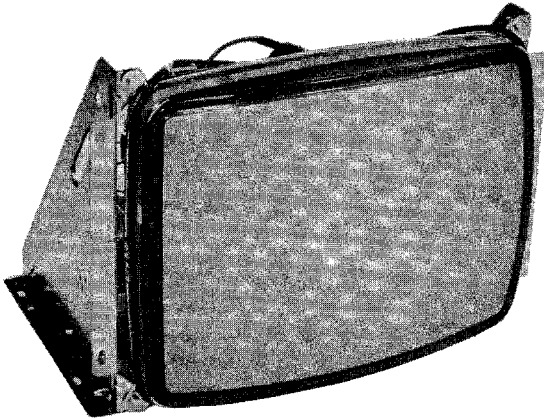

### MODELS

19K4951  
19K4956

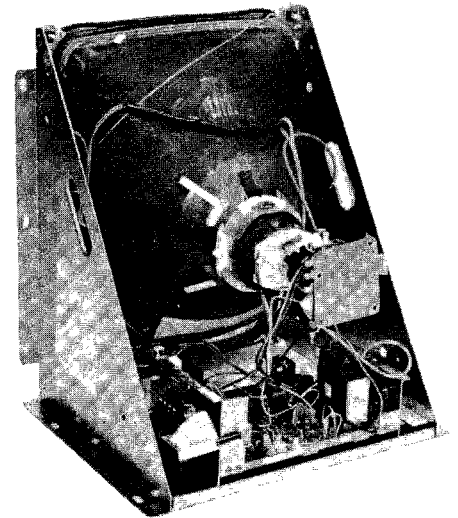

**WELLS-GARDNER ELECTRONICS  
CORPORATION**

---

2701 NORTH KILDARE AVENUE  
CHICAGO, ILLINOIS 60639

## WARNINGS

### 1. Power Up Warning—

An isolation transformer must be used between the AC supply and the AC plug of the monitor before servicing or testing is performed since the chassis and the heat sink are directly connected to one side of the AC line which could present a shock hazard.

Before servicing is performed, read all the precautions labelled on the CRT and chassis.

### 2. **X-RAY RADIATION WARNING NOTICE**

**WARNING:** PARTS WHICH INFLUENCE X-RAY RADIATION IN HORIZONTAL DEFLECTION, HIGH VOLTAGE CIRCUITS AND PICTURE TUBE ETC. ARE INDICATED BY (★) IN THE PARTS LIST FOR REPLACEMENT PURPOSES. USE ONLY THE TYPE SHOWN IN THE PARTS LIST.

### 3. High Voltage—

This monitor contains HIGH VOLTAGES derived from power supplies capable of delivering LETHAL quantities of energy. Do not attempt to service until all precautions necessary for working on HIGH VOLTAGE equipment have been observed.

### 4. CRT Handling—

Care must be taken not to bump or scratch the picture tube as this may cause the picture tube to implode resulting in personal injury. Shatter proof goggles must be worn when handling the CRT. High voltage must be completely discharged before handling. Do not handle the CRT by the neck.

### 5. **PRODUCT SAFETY NOTICE**

**WARNING:** FOR CONTINUED SAFETY REPLACE SAFETY CRITICAL COMPONENTS ONLY WITH MANUFACTURER RECOMMENDED PARTS. THESE PARTS ARE IDENTIFIED BY SHADING AND BY (Δ) ON THE SCHEMATIC DIAGRAM.

**AVERTISSEMENT:** POUR MAINTENIR LE DEGRE DE SECURITE DE L'APPAREIL NE REMPLACER LES COMPOSANTS DONT LE FONCTIONNEMENT EST CRITIQUE POUR LA SECURITE QUE PAR DES PIECES RECOMMANDEES PAR LE FABRICANT.

For replacement purposes, use the same type or specified type of wire and cable, assuring the positioning of the wires is followed (especially for H.V. and power supply circuits). Use of alternative wiring or positioning could result in damage to the monitor or in a shock or fire hazard.

## PERFORMANCE AND OPERATING DATA

1. Apply a suitable power source to the monitor through an isolation transformer.

2. Apply a suitable signal source to the monitor PCB by means of P201 and P202

3. Set Up Controls.

All controls are preset at the factory, but may be adjusted to suit program material.

### 1.0 Supply

Voltage 108 VAC-132 VAC

Frequency 50 Hz-60 Hz

Note: Apply supply voltage through an isolation transformer with 1 Amp. minimum capability.

### 2.0 High Voltage (EHT)

For 19"V models 24.3 ± 0.8 K.V. at 0 Beam; 22.8 ± 0.8 K.V. at 1 mA Beam

Note: Condition for above: A.C. = 120V

### 3.0 Service Set-Up Controls

#### MAIN PC BOARD

3.1 Vertical Hold Control, VR301

3.2 Vertical Size Control, VR303

3.3 Horizontal Hold Control, VR351

3.4 Vertical Raster Position Adjustment  
Jumper (3 positions)

3.5 Horizontal Raster Position Adjustment  
Jumper (3 positions)

3.6 Screen Control (Part of H.V. Unit, T352)

3.7 Focus Control (Part of H.V. Unit, T352)

3.8 Horizontal Width Coil, L352

3.9 Black Level Control, VR201

3.10 Horizontal Video Position Control,  
(Horizontal Shift) VR352

#### NECK PC BOARD

3.11 Video Drive Controls, Red VR401

Green VR402

3.12 CRT Cut Off Controls, Red VR403

Green VR404

Blue VR405

## SERVICE INSTRUCTIONS

**NOTE:** All monitors are equipped with automatic degaussing coils (L701) which demagnetize the picture tube every time the monitor is turned on after being off for a minimum of 5 minutes. Should any part of the chassis become magnetized it will be necessary to degauss the affected area with a manual degaussing coil. Move the coil slowly around the CRT face area and all surrounding metal parts. Then slowly withdraw for a distance of 6 feet before turning off.

### 1.0 BLACK LEVEL CONTROL ADJUSTMENT

This control has been set at the factory and should not need further attention, however, when the game is connected a slight adjustment of VR201 may be necessary to obtain the proper black level (the black portion of the picture just extinguished).

### 2.0 VERTICAL SIZE (HEIGHT)

Location of this control is shown in Fig. 1. This control must be adjusted slowly, if necessary, until the picture or test pattern attains the correct vertical proportions.

### 3.0 CIRCUIT PROTECTION

A 4.0A pigtail fuse, mounted on the Main Board has been provided to protect the Power Output Circuit.

### 4.0 FOCUS

Adjust the Focus control, located on the HV unit (T352), for maximum over-all definition and fine picture detail.

### 5.0 HORIZONTAL HOLD CONTROL ADJUSTMENT, VR351 (See Fig. 1)

A warm-up period of at least five minutes should be allowed before alignment is carried out. With the monitor being driven from the game signal, short TP601 to TP31. Adjust VR351 until the picture stops sliding horizontally. Remove the short.

### 6.0 HORIZONTAL VIDEO POSITION

If the video is off center on the raster some compensation can be made by adjusting this control.

### 7.0 VERTICAL RASTER POSITION ADJUSTMENT

If the video is off center vertically, (short dimension of picture tube) some compensation can be made by moving the vertical raster position adjustment jumper to either positions "U" or "D".

### 8.0 HORIZONTAL RASTER POSITION ADJUSTMENT

If the video is off center horizontally (long dimension of the picture tube) some compensation can be made by moving the horizontal raster position adjustment jumper to either positions "R" or "L".

### 9.0 HORIZONTAL WIDTH ADJUSTMENT

The horizontal width coil is a hexagonal tuning tool adjustment. This control must be adjusted slowly, if necessary, until the picture or test pattern attains the correct horizontal proportions.

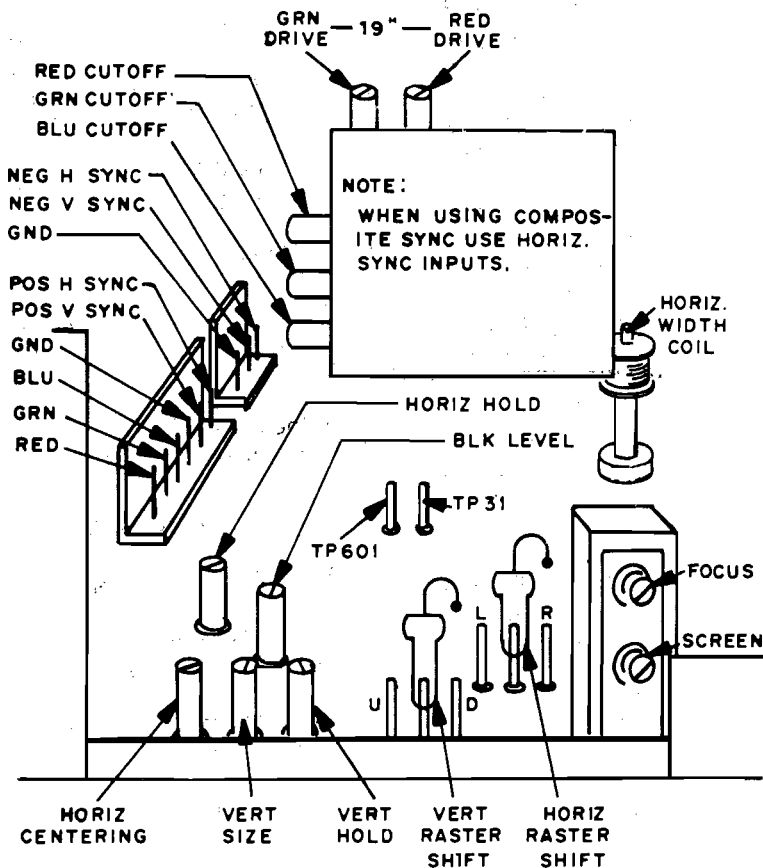

FIGURE 1

# INSTALLATION AND SERVICE INSTRUCTIONS

**NOTE:** All of the following procedures have been performed at the factory and should require no further attention. If the monitor is serviced for any reason, it should be observed afterward to determine whether any of these procedures need to be performed again.

## OUTLINE OF CONVERGENCE AND SET-UP PROCEDURE

- 1.0 Degaussing-Demagnetize the shadow mask and all surrounding metal parts with an external degaussing coil.
  - 2.0 Purity and Vertical Centering—Adjust the purity magnet and the yoke position.
  - 3.0 Static Convergence-Converge Red and Blue on Green in the center of the screen.
  - 4.0 Dynamic Convergence-Converge Red and Blue at the edges of the screen.
  - 5.0 White Balance-Set Gray and White brightness tracking.
- NOTE: Number 2.0 and 3.0 adjustments interact.

### 1.0 DEGAUSSING

The monitor is equipped with an automatic degaussing circuit. However, if the CRT shadow mask has become excessively magnetized, it may be necessary to degauss it with a manual coil. Do not switch the coil OFF while the raster shows any effect from the coil.

### 2.0 COLOR PURITY AND VERTICAL CENTERING ADJUSTMENT

- 2.1 For best results, it is recommended that the purity adjustment be made in the final monitor location. If the monitor will be moved, perform this adjustment with it facing west or east. The monitor must have been operating 15 minutes prior to this procedure.
- 2.2 Set the converger assembly on the CRT neck with the center line (of the Purity Adjustment Magnet) over the gap between grids no. 3 & 4. (See Figures 2 & 6)
- 2.3 Make certain that the magnetic ring-pairs are in their correct positions before starting procedure. This produces a zero-correction state and helps facilitate adjustments.
- 2.4 Vertical raster position adjustment jumper must be in position "C" (center).
- 2.5 Remove the R-G-B signal from the monitor.
- 2.6 Turn the Green Cut off Control (VR404) on the Neck Board fully CW. (See Fig. 3)
- 2.7 Turn the Red and Blue Cut off Controls (VR403 & VR405) fully CCW.
- 2.8 Pull the Deflection Yoke backward so that the Green belt will appear. (See Fig. 4)
- 2.9 Decrease the horizontal width of the raster, if necessary, in order to be able to see the right and left edges of the raster.
- 2.10 Move the two Purity Magnets with respect to each other in order to center the raster on the screen and the Green belt on the raster horizontally.
- 2.11 Push the Deflection Yoke forward gradually and fix it at the place where the Green screen becomes uniform throughout.
- 2.12 Turn the Cut off and Drive Controls and confirm that each color is uniform.
- 2.13 If the color is not uniform, re-adjust it moving the Purity Magnets slightly.
- 2.14 Decrease the vertical size of the raster, if necessary, such that the top and bottom raster edges can be seen.

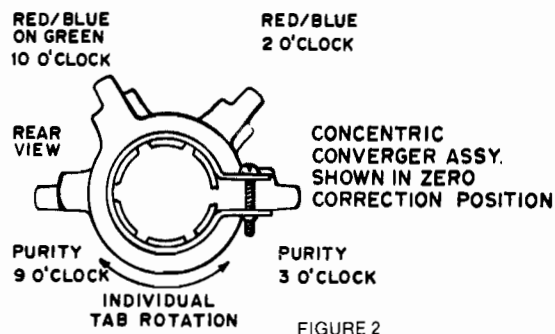
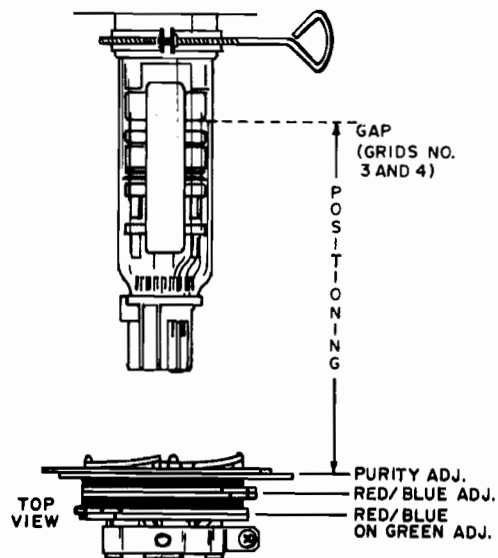

FIGURE 2

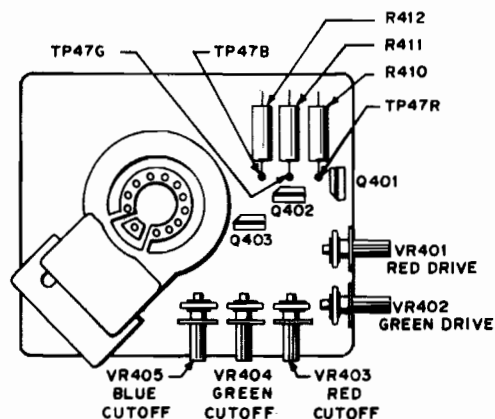

FIGURE 3

### NECK BOARD

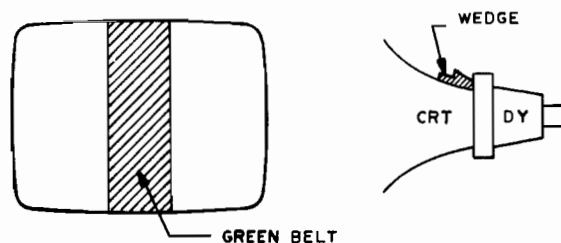

FIGURE 4



- 2.15 Rotate the Purity Magnets as a pair (without changing the angle of one magnet relative to the other) in order to center the raster on the screen vertically.
- 2.16 Readjust the raster to the desired vertical size.
- 2.17 Turn all three cut off controls fully counterclockwise (CCW). Slowly turn up (CW) the Red cutoff control until a Red raster is just barely visible.
- 2.18 Slowly turn up the Green and Blue cutoff controls such that their associated colors, mixing with the Red, results in a White or Gray raster.
- 2.19 Confirm that the white or gray color is uniform throughout the screen.
- 2.20 Insert a wedge temporarily as shown in Fig. 4 and adjust the angle of the Deflection Yoke.

### 3.0 STATIC CONVERGENCE ADJUSTMENT

4-Pole Magnets and 6-Pole Magnets are for static convergence.

- 3.1 A cross hatch signal should be connected to the monitor.
- 3.2 A pair of 4-Pole Convergence Magnets is provided and adjusted to converge the blue and red beams. (See Fig. 6) When the Pole opens to the left and right 45° symmetrically, the magnetic field maximizes. Red and blue beams move to the left and right. (See Fig. 5) Variation of the angle between the tabs adjusts the convergence of red and blue vertical lines.
- 3.3 When both 4-Pole Convergence Magnet Tabs are rotated as a pair, the convergence of the red and blue horizontal lines is adjusted.
- 3.4 A pair of 6-Pole Convergence Magnets is also provided to converge the magenta (red + blue) to green beams. (See Fig. 6). When the Pole opens to the left and right 30° symmetrically, the magnetic field is maximized. Red and blue beams both move to the left and right (See Fig. 5). Variation of the opening angle adjusts the convergence of magenta to green vertical lines.
- 3.5 When both 6-Pole Convergence Magnet Tabs are rotated as a pair, the convergence of magenta to green horizontal lines is adjusted.

GREEN GUN IS THE CENTER GUN.  
CONVERGE THE RED AND BLUE.  
THEN CONVERGE RED AND BLUE ON GREEN.

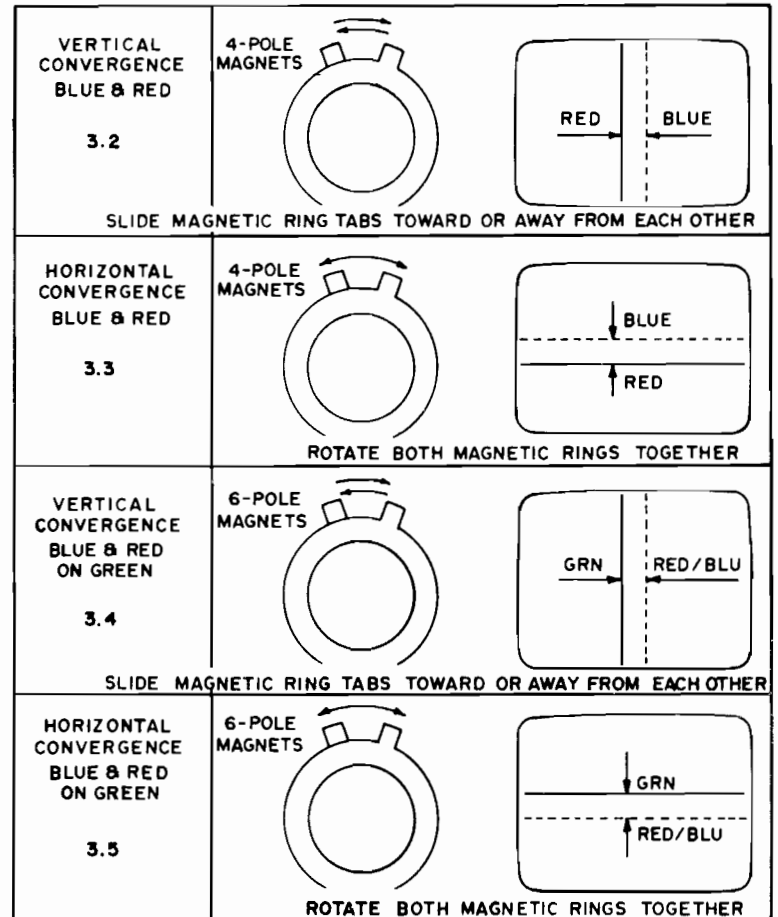

REPEAT 3.2 & 3.3 IF ALL LINES ARE NOT CONVERGED AT CENTER

5827

FIGURE 5

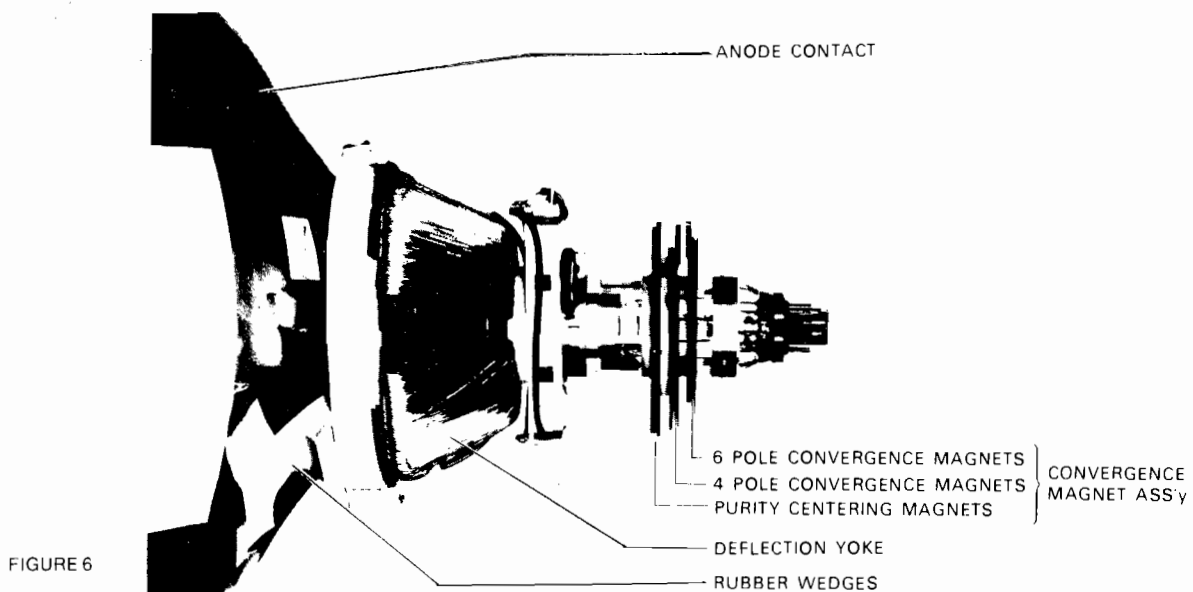

FIGURE 6

#### 4.0 PRECISE ADJUSTMENT OF DYNAMIC CONVERGENCE (See Fig. 7, 8 and 9)

- 4.1 Feed a cross hatch signal to the monitor.
- 4.2 Insert a wedge temporarily and fix the Deflection Yoke so as to obtain the best circumference convergence (See Fig. 8 and 9)

**NOTE:**

The wedges may need to be moved during adjustments.

- 4.3 Insert three rubber wedges to the position as shown in Fig. 7 to obtain the best circumference convergence.

**NOTE:**

- 1) Tilting the angle of the yoke up and down adjusts the crossover of both vertical and horizontal red and blue lines. See Fig. 8 (a) and (b).
- 2) Tilting the angle of the yoke sideways adjusts the parallel convergence of both horizontal and vertical lines at the edges of the screen. See Fig. 9 (a) and (b).
- 3) Use three rubber wedges (tapered rubber wedges are used for a purpose).
- 4) The position of each rubber wedge is shown in Fig. 7.
- 5) Do NOT force the permanent wedges in. They are to be inserted until they just make contact with the yoke—after the yoke has been positioned.
- 6) Fix the three permanent rubber wedges with chloroprene rubber adhesive.
- 7) After the adhesive has dried enough to hold the wedges in place, carefully remove the temporarily installed wedge.

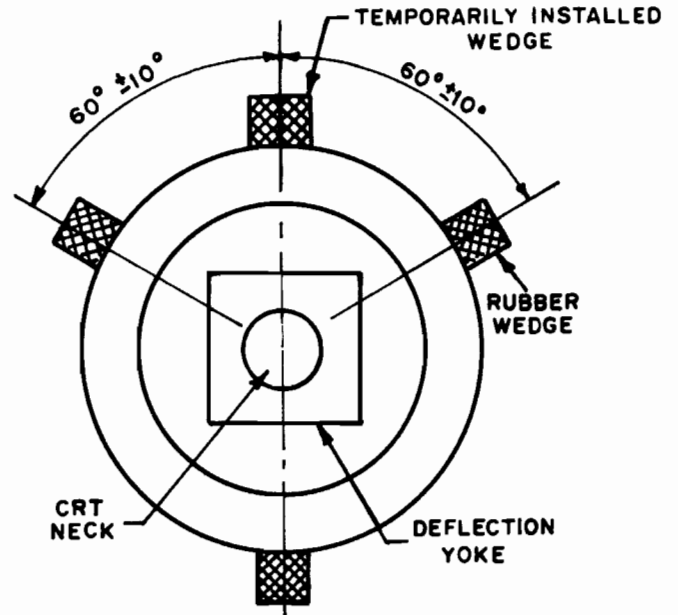

FIGURE 7

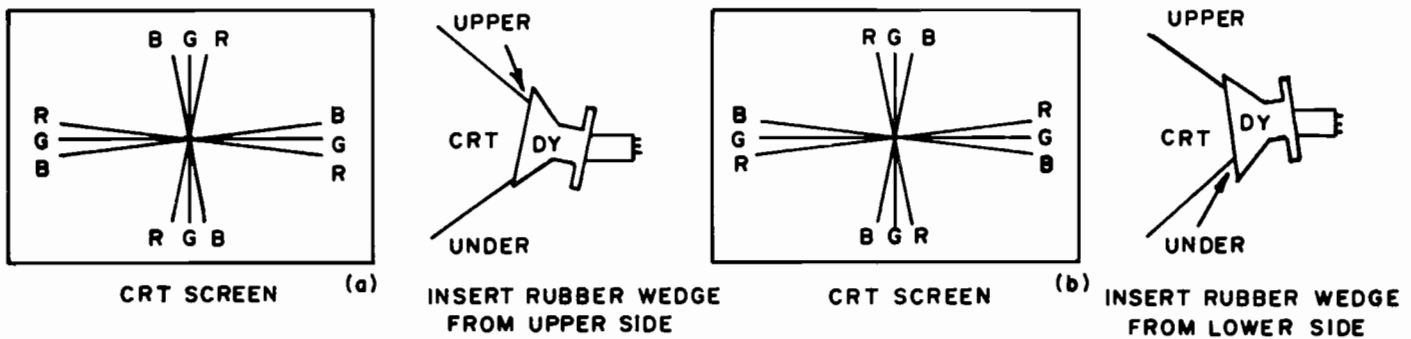

FIGURE 8

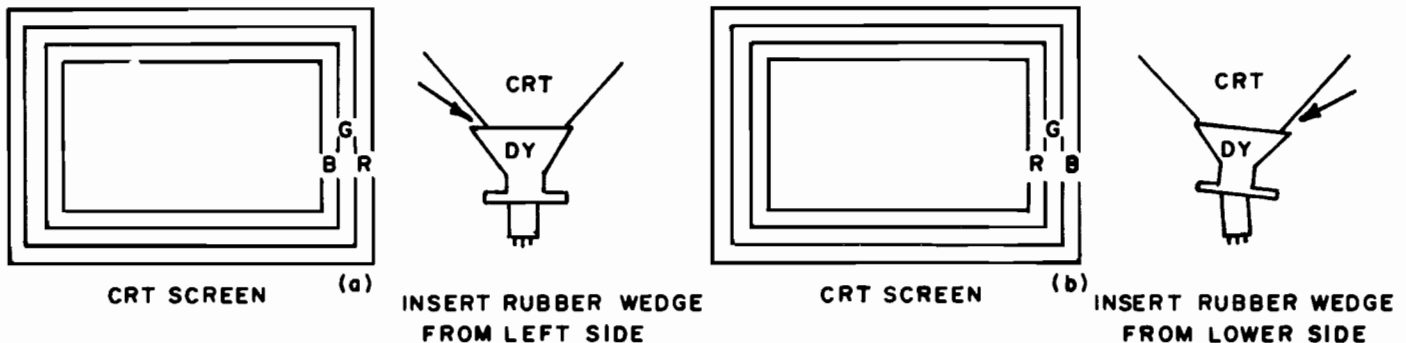

FIGURE 9

## 5.0 WHITE BALANCE

- 5.1 Refer to Fig. 2 and do the following in subdued light.
- 5.2 Ground the R/G/B inputs.
- 5.3 Set the R/G drive controls to their mechanical centers.
- 5.4 Set the screen and R/G/B cutoff controls to minimum (fully CCW).
- 5.5 Connect a jumper wire between TP301 and TP302 (located on the MAIN PCB)
- 5.6 Slowly turn up (CW) the screen control until the first colored line becomes just barely visible. That color which has just appeared is referred to as the "lead" color. Do NOT turn its associated cutoff control—it must remain fully CCW.
- 5.7 Connect a DC oscilloscope to the collector of the lead color's output transistor (Q401, Q402, or Q403) on the Neck PCB at TP47R, TP47G, or TP47B.
- 5.8 Adjust the black level control (VR201) to obtain the waveform shown in Fig. 10.
- 5.9 Readjust the screen control such that the colored line is just barely visible.
- 5.10 Slowly turn up the two remaining cutoff controls such that their associated colors, mixing with the lead color, results in a white or gray line.
- 5.11 Remove the jumper wire.
- 5.12 Adjust the Black Level Control for a dim raster. Touch up the two trailing cutoff controls (NOT the lead cutoff control) for best gray uniformity.
- 5.13 Adjust the Black Level Control for a bright raster. Adjust the R/G drive controls, if necessary for best neutral white.
- 5.14 Repeat steps 5.12 and 5.13 until good tracking of white balance is achieved.

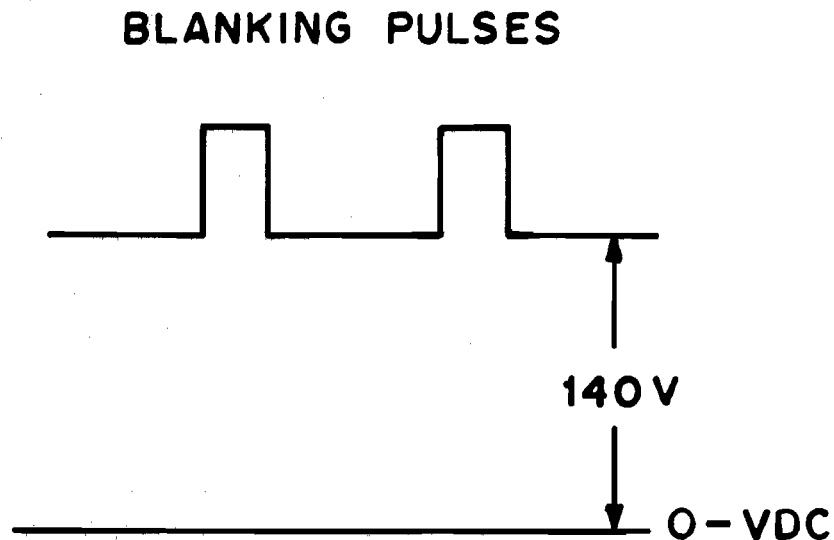

FIGURE 10

## REPLACEMENT PARTS LIST

This monitor contains circuits and components included specifically for safety purposes.

For continued protection no changes should be made to the original design, and components shown in shaded areas of schematic, or **Δ ★** on parts list should be replaced with exact factory replacement parts.

The use of substitute parts may create a shock, fire, radiation or other hazard. Service should be performed by qualified personnel only.

### MAIN BOARD

Ref. No.	Part No.	Description	Ref. No.	Part No.	Description
<b>RESISTORS</b>			<b>RESISTORS (CONT.)</b>		
R201	203X6500-645	1K Ohm, 5%, 1/4W Carbon	R369	203X5602-329	680K Ohm, 5%, 1/2W Comp.
R202	203X6500-523	30 Ohm, 5%, 1/4W Carbon	R370	203X6501-002	33K Ohm, 5%, 1/4W Carbon
R203	203X6500-405	100 Ohm, 5%, 1/4W Carbon	R371	203X9014-584	1K Ohm, 5%, 1W Metal Oxide
R204	203X6700-327	100 Ohm, 5%, 1/2W Carbon	R372	203X9101-119	12K Ohm, 5%, 1W Metal Oxide
R205	203X6700-421	270 Ohm, 5%, 1/2W Carbon	R375	203X6700-763	6.8K Ohm, 5%, 1/2W Carbon
R206	203X6500-540	390 Ohm, 5%, 1/4W Carbon	R376	203X9104-404	270 Ohm, 5%, 2W Metal Oxide
R207	340X2201-934	200 Ohm, 5%, 1/4W Carbon	R377	203X6500-447	150 Ohm, 5%, 1/4W Carbon
R208	203X6500-540	390 Ohm, 5%, 1/4W Carbon	R378	203X6500-886	10K Ohm, 5%, 1/4W Carbon
R209	340X2201-934	200 Ohm, 5%, 1/4W Carbon	R379	203X6500-886	10K Ohm, 5%, 1/4W Carbon
R210	203X6500-540	390 Ohm, 5%, 1/4W Carbon	R380	203X6500-865	8.2K Ohm, 5%, 1/4W Carbon
R211	340X2201-934	200 Ohm, 5%, 1/4W Carbon	R381	203X6500-724	2.2K Ohm, 5%, 1W Metal Oxide
R214	203X6500-645	1K Ohm, 5%, 1/4W Carbon	R383	203X9014-387	150 Ohm, 5%, 1W Metal Oxide
R215	203X6501-126	100K Ohm, 5%, 1/4W Carbon	R502	203X6500-886	10K Ohm, 5%, 1/4W Carbon
R216	203X6500-645	1K Ohm, 5%, 1/4W Carbon	R503	204X1700-535	150 Ohm, 5%, 15W Metal Oxide
R217	203X6500-405	100 Ohm, 5%, 1/4W Carbon	R504	203X9014-267	47 Ohm, 5%, 1W Metal Oxide
R218	203X6500-645	1K Ohm, 5%, 1/4W Carbon	R505	203X6501-209	2.2K Ohm, 5%, 1/4W Carbon
R219	203X6501-126	100K Ohm, 5%, 1/4W Carbon	R506	203X9104-105	15 Ohm, 5%, 2W Metal Oxide
R220	203X6500-645	1K Ohm, 5%, 1/4W Carbon	R507	203X5602-185	350K Ohm, 5%, 1/2W Comp.
R221	203X6500-405	100 Ohm, 5%, 1/4W Carbon	Δ ★ R601	204X1625-058	3.3 Ohm, 5%, 10W WW
R222	203X6500-762	3.3 Ohm, 5%, 1/4W Carbon	R701	203X9105-141	2.2 Ohm, 5%, 2W Metal Oxide
R224	203X6500-169	10 Ohm, 5%, 1/4W Carbon	R702	203X6206-441	2.2 Ohm, 5%, 1/2W Carbon
R225	203X6500-169	10 Ohm, 5%, 1/4W Carbon	VR201	204X2070-072	2K Ohm-B Semi-Fixed
R226	203X6500-169	10 Ohm, 5%, 1/4W Carbon	VR301	204X2070-084	5K Ohm-B Semi-Fixed
R227	203X6501-044	47K Ohm, 5%, 1/4W Carbon	VR303	204X2070-055	500 Ohm-B Semi-Fixed
R228	203X6500-645	1K Ohm, 5%, 1/4W Carbon	VR351	204X2070-072	2K Ohm-B Semi-Fixed
R229	203X6700-421	270 Ohm, 5%, 1/2W Carbon	VR352	204X2070-072	2K Ohm-B Semi-Fixed
R230	203X6500-863	8.2K Ohm, 5%, 1/2W Comp.			
R231	203X6500-863	8.2K Ohm, 5%, 1/2W Comp.			
R232	203X6500-863	8.2K Ohm, 5%, 1/2W Comp.			
R233	203X6500-468	180 Ohm, 5%, 1/4W Carbon			
R234	340X2820-934	82 Ohm, 5%, 1/4W Carbon			
R235	340X2820-934	82 Ohm, 5%, 1/4W Carbon	C201	203X0014-088	1000 uF, 16V, Electrolytic
R236	340X2820-934	82 Ohm, 5%, 1/4W Carbon	C202	202X7200-064	330 pF, 500V, Ceramic
R301	203X6500-508	270 Ohm, 5%, 1/4W Carbon	C203	202X7200-043	220 pF, 500V, Ceramic
R302	203X6500-863	8.2K Ohm, 5%, 1/4W Carbon	C204	202X7200-043	220 pF, 500V, Ceramic
R303	203X6500-863	8.2K Ohm, 5%, 1/4W Carbon	C205	203X0014-076	470 uF, 16V, Electrolytic
R304	203X6500-724	2.2K Ohm, 5%, 1/4W Carbon	C206	203X1810-149	0.1 uF, 125V Mylar
R305	203X6500-842	6.8K Ohm, 5%, 1/4W Carbon	C207	349X2232-109	.022 uF, 100V Mylar
R306	203X6003-201	7.5K Ohm, 2%, 1/4W Carbon	C301	203X0014-065	330 uF, 50V Electrolytic
R307	203X6500-825	5.6K Ohm, 5%, 1/4W Carbon	C302	203X1600-563	0.033 uF, 50V Mylar
R309	203X6500-965	22K Ohm, 5%, 1/4W Carbon	C303	203X0629-037	3.3 uF, 50V Electrolytic
R310	203X6500-988	39K Ohm, 5%, 1/4W Carbon	C304	203X1600-366	0.068 pF, 50V Mylar
R311	203X6500-762	3.3K Ohm, 5%, 1/4W Carbon	C306	203X0412-012	2.2 uF, 16V Tantal
R312	203X9014-741	4.7K Ohm, 5%, 1/4W Carbon	C307	203X1600-634	0.033 uF, 50V Mylar
R313	204X1450-537	1K Ohm, 5%, 5W Carbon	C308	203X0025-174	3.3 uF, 50V Electrolytic
R314	203X6500-481	220 Ohm, 5%, 1/4W Carbon	C309	203X1207-100	0.068 uF, 100V PP
R315	203X6500-169	10 Ohm, 5%, 1/4W Carbon	C310	203X0629-061	10 uF, 100V Electrolytic
R316	203X6500-762	3.3K Ohm, 5%, 1/4W Carbon	C311	203X0041-025	10 uF, 160V Electrolytic
R317	203X6700-107	12 Ohm, 5%, 1/2W Carbon	C312	202X7050-248	1000 pF, 500V Ceramic
R318	203X6500-540	390 Ohm, 5%, 1/4W Carbon	C313	203X0040-052	47 uF, 160V Electrolytic
R319	203X6500-645	1K Ohm, 5%, 1/4W Carbon	C314	203X1201-265	0.033 uF, 200V PP
R320	203X6501-002	33K Ohm, 5%, 1/4W Carbon	C315	203X0629-023	1 uF, 50V Electrolytic
R321	203X6501-224	270K Ohm, 5%, 1/2W Carbon	C351	203X0629-023	1 uF, 50V Electrolytic
R322	203X6500-886	10K Ohm, 5%, 1/4W Carbon	C352	203X0619-045	47 uF, 25V Electrolytic
R351	203X6500-886	10K Ohm, 5%, 1/4W Carbon	C353	203X1190-015	0.0082 pF, 50V Mylar-PP
R352	203X6500-785	3.9K Ohm, 5%, 1/4W Carbon	C354	203X0619-045	47 uF, 25V Electrolytic
R353	203X6501-088	68K Ohm, 5%, 1/4W Carbon	C355	203X1600-366	0.0068 pF, 50V Mylar
R354	203X6500-762	3.3K Ohm, 5%, 1/4W Carbon	C356	202X7050-483	0.01 uF, 500V Ceramic
R355	203X9205-143	6.8K Ohm, 5%, 3W Metal Oxide	C359	202X8065-606	100 pF, 500V Ceramic
R358	203X5601-878	56K Ohm, 5%, 1/2W Carbon	C360	202X7050-366	0.0033 pF, 500V Ceramic
R360	203X6500-561	470 Ohm, 5%, 1/4W Carbon	C361	202X7050-483	0.01 uF, 500V Ceramic
R361	203X6500-886	10K Ohm, 5%, 1/4W Carbon	C362	202X7203-032	0.01 uF, 50V Ceramic
R362	203X9014-645	1.8K Ohm, 5%, 1W Metal Oxide	Δ ★ C363	203X1270-911	8700 pF, 1.5 KV PP
★ R363	204X1527-751	3.9K Ohm, 5%, 7W Metal Oxide	★ C365	203X1201-265	0.33 uF, 200V PP
R364	203X6500-246	22 Ohm, 5%, 1/4W Carbon	C366	203X0019-026	22 uF, 25V Electrolytic
R365	203X6501-002	33K Ohm, 5%, 1/4W Carbon	C367	202X8065-162	6 pF, 500V Ceramic
R367	203X6500-886	10K Ohm, 5%, 1/4W Carbon	C368	202X7203-032	0.01 uF, 50V Ceramic
R368	203X5602-185	330K Ohm, 5%, 1/2W Comp.	C372	203X1207-125	0.1 uF, 100V PP

# P.C. BOARD LAYOUT

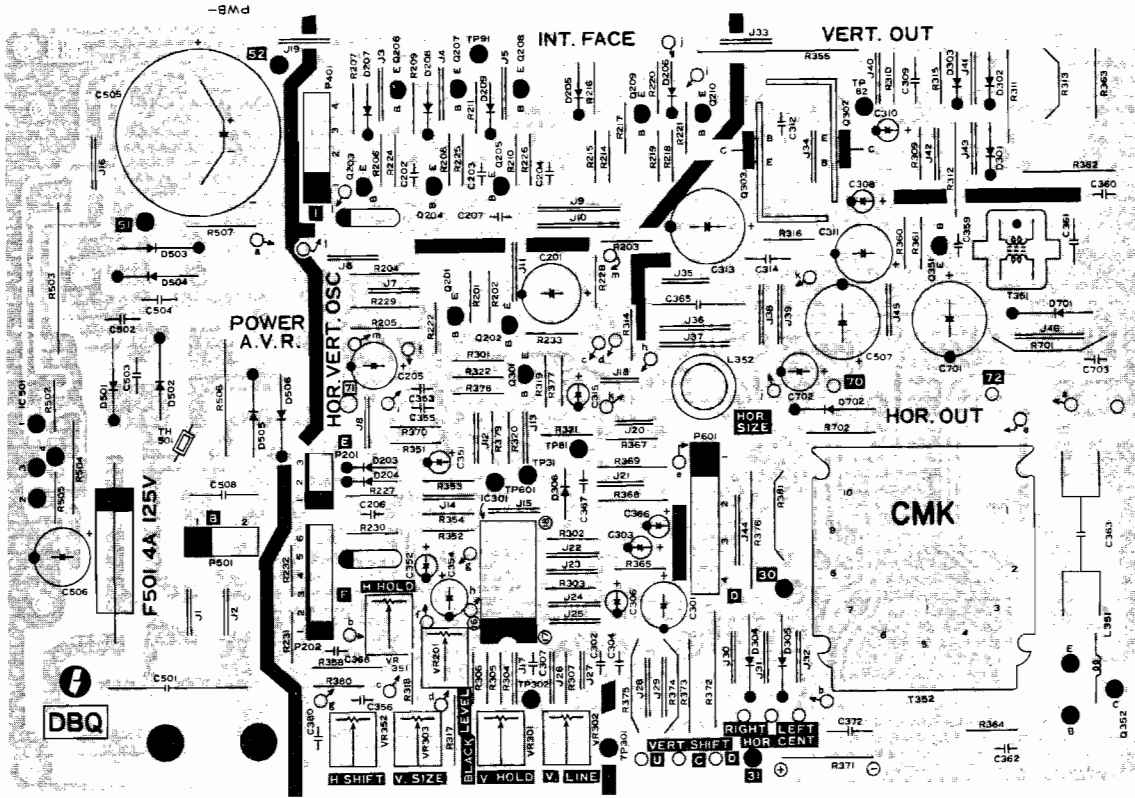

TOP VIEW

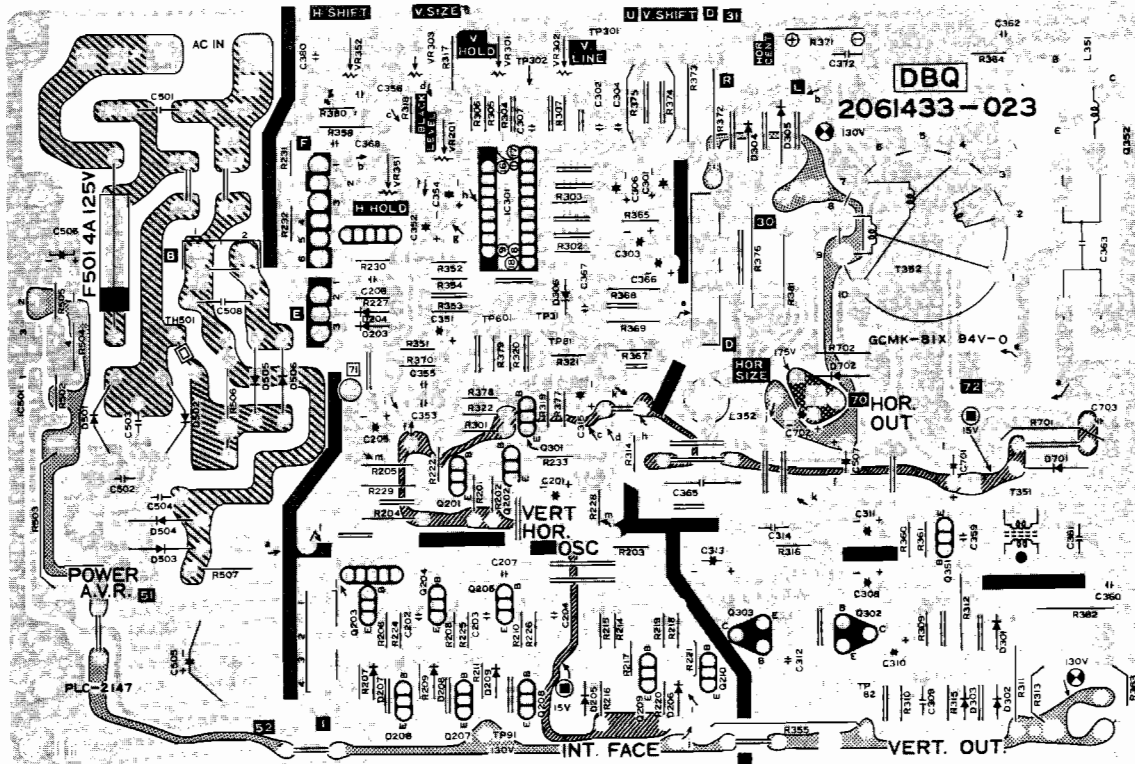

BOTTOM VIEW

FIGURE 11 MAIN P.C. BOARD

# P.C. BOARD LAYOUT

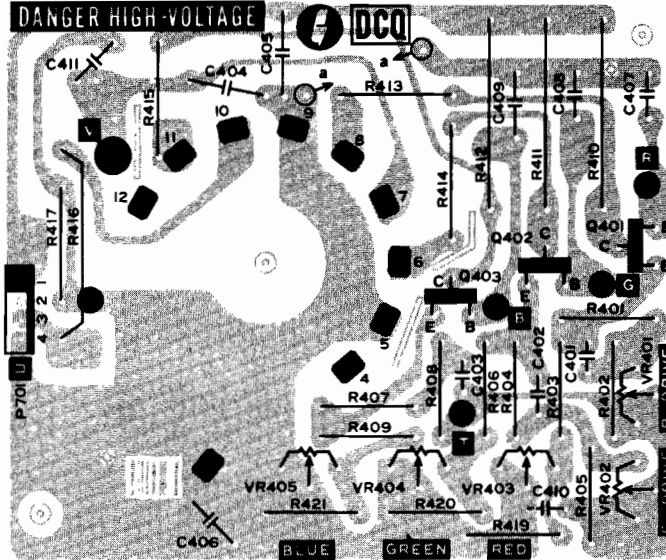

TOP VIEW

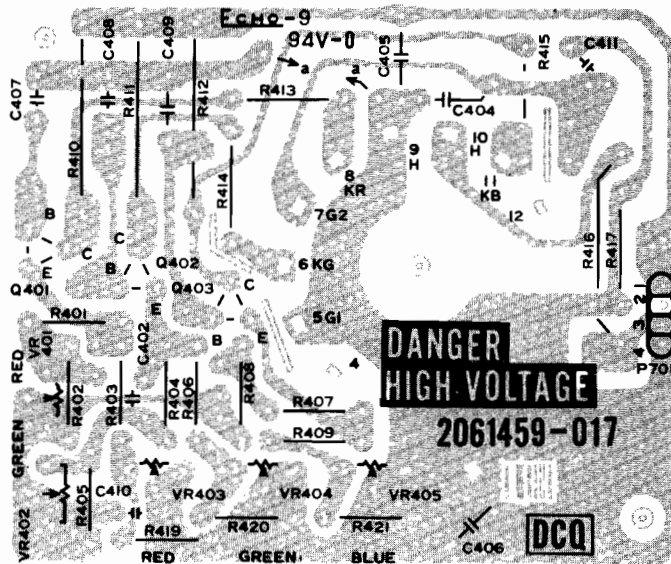

BOTTOM VIEW

FIGURE 12 NECK P.C. BOARD

# MAIN BOARD (CONT.)

Ref. No.	Part No.	Description	Ref. No.	Part No.	Description
<b>CAPACITORS (CONT.)</b>			<b>SEMICONDUCTORS (CONT.)</b>		
C380	202X7200-087	470 uF, 500V Ceramic	Q206	200X3181-523	Transistor (NPN) 2SC1815GR
△ C501	203X1810-149	0.1 uF, 125V Mylar	Q207	200X3181-523	Transistor (NPN) 2SC1815GR
△ C502	202X7050-282	1500 pF, 500V Ceramic	Q208	200X3181-523	Transistor (NPN) 2SC1815GR
△ C503	202X7810-214	2200 pF, 125V Ceramic	Q209	200X3181-523	Transistor (NPN) 2SC1815GR
△ C504	202X7810-214	2200 pF, 125V Ceramic	Q210	200X3181-523	Transistor (NPN) 2SC1815GR
C505	203X0220-075	560 uF, 200V Electrolytic	Q301	200X3181-523	Transistor (NPN) 2SC1815GR
C506	203X0040-034	22 uF, 160V Electrolytic	Q302	200X3207-306	Transistor (NPN) 2SC2073LBGL2
C507	203X0041-057	47 uF, 160V Electrolytic	Q303	200X3207-306	Transistor (NPN) 2SC2073LBGL2
C701	203X0019-092	1000 uF, 25V Electrolytic	Q351	200X3248-217	Transistor (NPN) 2SC2482BK
C702	203X0634-061	10 uF, 100V Electrolytic	Q352	200X4589-802	Transistor (NPN) 2SD898B
C703	202X7050-248	1000 pF, 500V Ceramic	IC301	200X2300-033	IC HA11423
<b>SEMICONDUCTORS</b>			△ ★ IC501	200X2600-183	IC STR381
D203	201X2010-159	Diode, IS2076-27	L351	201X4710-134	Coil, (RF Choke)
D204	201X2010-159	Diode, IS2076-27	L352	201X5000-083	Coil, Horiz. Size
D205	201X2010-159	Diode, IS2076-27	L701	611X0004-007	Coil, Adg.
D206	201X2010-159	Diode, IS2076-27	T351	202X1300-080	Transformer, Hor. Drive
D207	201X2010-159	Diode, IS2076-27	△ ★ T352	200X9720-301	HV-Unit M-11
D208	201X2010-159	Diode, IS2076-27	△ F501	204X1120-073	Fuse, 4 Amp. 125V
D209	201X2010-159	Diode, IS2076-27	J402	206X5008-632	Recep W Wire 3P-M-BG
D301	201X2010-165	Diode, ISS81	P201	204X9600-466	Plug, PWB 3P-J
D302	201X2010-159	Diode, IS2076-27	P202	204X9601-477	Plug, PWB 6P-Q
D303	201X2010-159	Diode, IS2076-27	P401	204X9600-298	Plug, PWB 4P-B
D304	201X2120-009	Diode, RH-IV	P501	204X9600-249	Plug, PWB 2P-B
D305	201X2120-009	Diode, RH-IV	P601	204X9600-304	Plug, PWB 4P-C
D306	201X2010-159	Diode, IS2076-27	TH501	201X0100-112	Thermistor
△ U501	201X3120-216	Diode, RM-1AV	<b>FINAL ASSEMBLY PARTS</b>		
△ U502	201X3120-216	Diode, RM-1AV	△ ★ 88X0138-506	19VLTP22 Plx Tube	
△ U503	201X3120-216	Diode, RM-1AV	205X9800-158	Lateral/Purity Assembly	
△ U504	201X3120-216	Diode, RM-1AV	△ ★ 202X1111-201	Yoke Deflection	
D505	201X3120-216	Diode, RM-1AV	204X9301-255	CRT Socket	
D506	201X3120-216	Diode, RM-1AV	291X5004-262	Automatic Degaussing Coil Unit	
D701	201X2130-234	Diode, RU-2V			
D702	201X2120-009	Diode, RH-1V			
Q201	200X3181-523	Transistor (NPN) 2SC1815GR			
Q202	200X3181-523	Transistor (NPN) 2SC1815GR			
Q203	200X4056-260	Transistor (PNP) 2SA562-Y-TM			
Q204	200X4056-260	Transistor (PNP) 2SA562-Y-TM			
Q205	200X4056-260	Transistor (PNP) 2SA562-Y-TM			

## NECK BOARD

RESISTORS			CAPACITORS		
R401	203X6000-729	220 Ohm, 5% 1/4W Carbon	C401	202X7050-269	1200 pF, 500V Ceramic
R402	203X6500-540	390 Ohm, 5% 1/4W Carbon	C402	202X7050-248	1000 pF, 500V Ceramic
R403	203X6000-661	820 Ohm, 5% 1/4W Carbon	C403	202X7050-248	1000 pF, 500V Ceramic
R404	203X6000-729	220 Ohm, 5% 1/4W Carbon	C404	202X7050-282	1500 pF, 1.5KV Ceramic
R405	203X6500-540	390 Ohm, 5% 1/4W Carbon	C405	202X7050-483	0.01 uF, 500V Ceramic
R406	203X6000-661	820 Ohm, 5% 1/4W Carbon	<b>SEMICONDUCTORS</b>		
R407	203X6000-729	470 Ohm, 5% 1/4W Carbon	Q401	200X3206-800	Transistor (NPN) 2SC2068LB
R408	203X6000-998	270 Ohm, 5% 1/4W Carbon	Q402	200X3206-800	Transistor (NPN) 2SC2068LB
R409	203X6000-661	820 Ohm, 5% 1/4W Carbon	Q403	200X3206-800	Transistor (NPN) 2SC2068LB
R410	203X9104-824	15K Ohm, 5% 2W M.O. Forming	<b>MISCELLANEOUS</b>		
R411	203X9104-824	15K Ohm, 5% 2W M.O. Forming	J401	206X5009-296	RECEP W Wire 4P-E
R412	203X9104-824	15K Ohm, 5% 2W M.O. Forming	P402	204X9600-254	Plug, PWB 3P-A
R413	203X6000-998	2.7K Ohm, 5% 1/2W Comp.	P403	204X9600-981	Plug, Pin 1P-D
R414	203X6000-998	2.7K Ohm, 5% 1/2W Comp.	P701	204X9601-020	Plug, PWB 4P-E
R415	203X6000-998	2.7K Ohm, 5% 1/2W Comp.			
R416	203X9105-154	2.2 Ohm, 5% 2W Metal Oxide			
R419	203X6500-741	2.7K Ohm, 5% 1/4W Carbon			
R420	203X6500-741	2.7K Ohm, 5% 1/4W Carbon			
R421	203X6500-741	2.7K Ohm, 5% 1/4W Carbon			
VR401	204X2115-014	500 Ohm, -B Semi-Fixed			
VR402	204X2115-014	500 Ohm, -B Semi-Fixed			
VR403	204X2115-006	5K Ohm, -B Semi-Fixed			
VR404	204X2115-006	5K Ohm, -B Semi-Fixed			
VR405	204X2115-006	5K Ohm, -B Semi-Fixed			

## TYPICAL DC VOLTAGES

TRANSISTOR NO.	TERMINAL		
	COLLECTOR	BASE	EMITTER
Q201	8.1	0.43	0.36
Q202	9.8	8.1	9.3
Q203	0	0.35	1.0
Q204	0	0.35	1.0
Q205	0	0.35	1.0
Q206	9.7	5.5	4.8
Q207	9.7	5.5	4.8
Q208	9.7	5.5	4.8
Q209	15.4	-0.30	0.01
Q210	14.0	0.31	0.17
Q301	15.5	4.7	4.2
Q302	79	37.8	37.7
Q303	37	0.51	0
Q351	41.4	0.41	0
Q352	DO NOT MEASURE	-0.03	0
Q401	139	9.7	9.3
Q402	139	9.7	9.3
Q403	139	9.7	9.3

I.C. 301	
PIN NO.	VOLTAGE
1	1.16
2	4.0
3	6.8
4	3.9
5	12.1
6	4.1
7	4.1
8	1.9
9	12.2
10	14.2
11	3.6
12	7.9
13	6.8
14	12.8
15	1.52
16	0
17	0.83
18	0

I.C. 501	
PIN NO.	VOLTAGE
1	163
2	130
3	0
4	132



# 19" COLOR MONITOR SCHEMATIC DIAGRAM

## MODELS 19K4901, 19K4906, 19K4951, 19K4956

Power Supply Voltage and Symbols

Symbol	Voltage	Operating Circuit
	15V	Vert. Osc. Sync Blanking CRT Cut-Off
	130V	Horiz. Osc. Horz. Drive Horz. Output Vert. Output
	175V	Video Output

★

**SERVICE TECHNICIAN WARNING**  
**X-RAY RADIATION PRECAUTION:**

THIS PRODUCT CONTAINS CRITICAL ELECTRICAL AND MECHANICAL PARTS ESSENTIAL FOR X-RAY RADIATION PROTECTION. FOR REPLACEMENT PURPOSES, USE ONLY TYPE PARTS SHOWN IN THE PARTS LIST.

⚠

**CAUTION: FOR CONTINUED SAFETY, REPLACE SAFETY CRITICAL COMPONENTS ONLY WITH MANUFACTURER'S RECOMMENDED PARTS.**  
**AVERTISSEMENT: POUR MAINTENIR LE DEGRE DE SECURITE DE L'APPAREIL NE REMPLACER LES COMPOSANTS DONT LE FONCTIONNEMENT EST CRITIQUE POUR LA SECURITE QUE PAR DES PIECES RECOMMANDEES PAR LE FABRICANT.**

### OSCILLOSCOPE WAVEFORM PATTERN

The waveforms shown are as observed on the wide band oscilloscope with the monitor turned to a reasonably strong signal and a normal picture. The voltages shown on each waveform are the approximate peak amplitudes.

If the waveforms are observed on the oscilloscope with a poor high frequency response, the corner of the pulses will tend to be more rounded than those shown and the amplitude of any high frequency pulse will tend to be less.

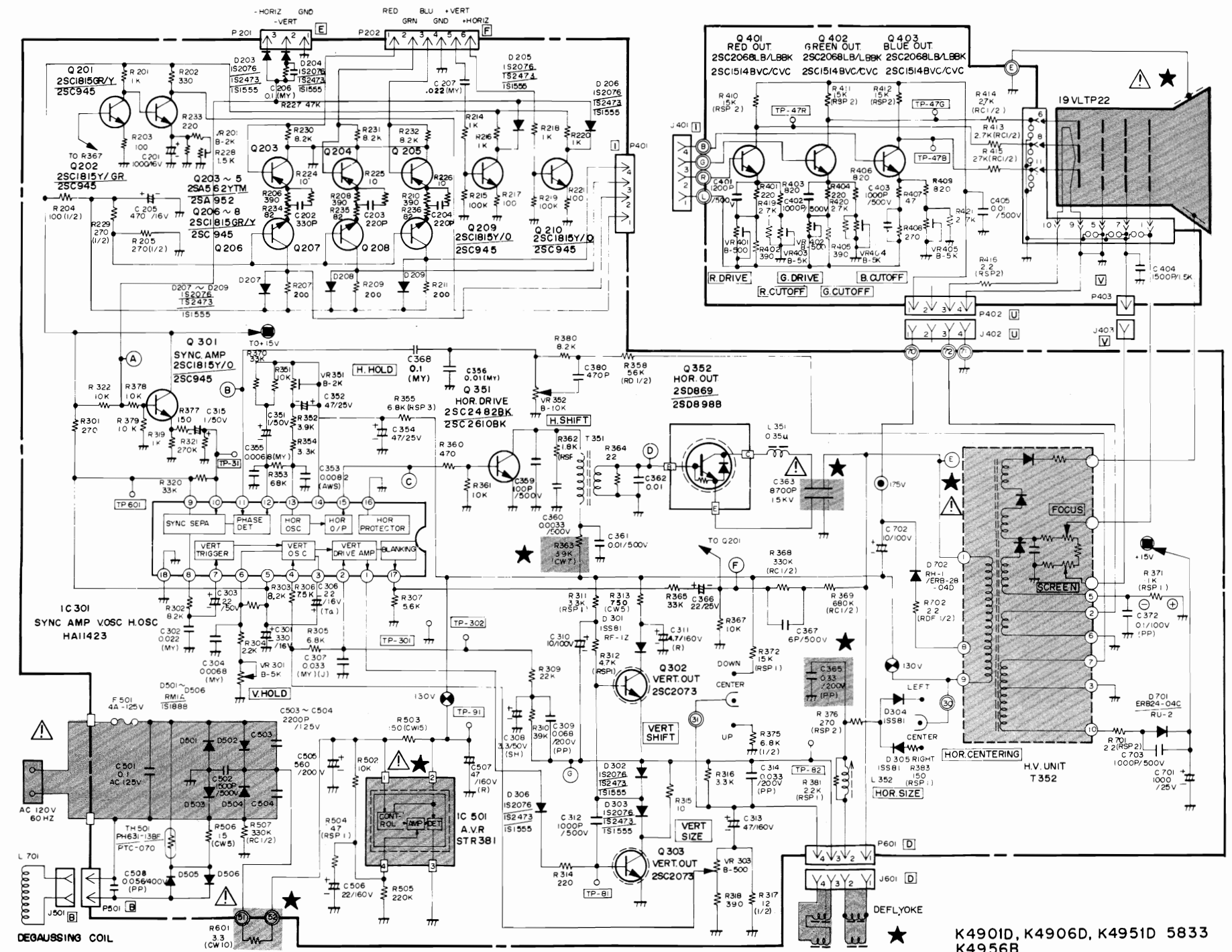
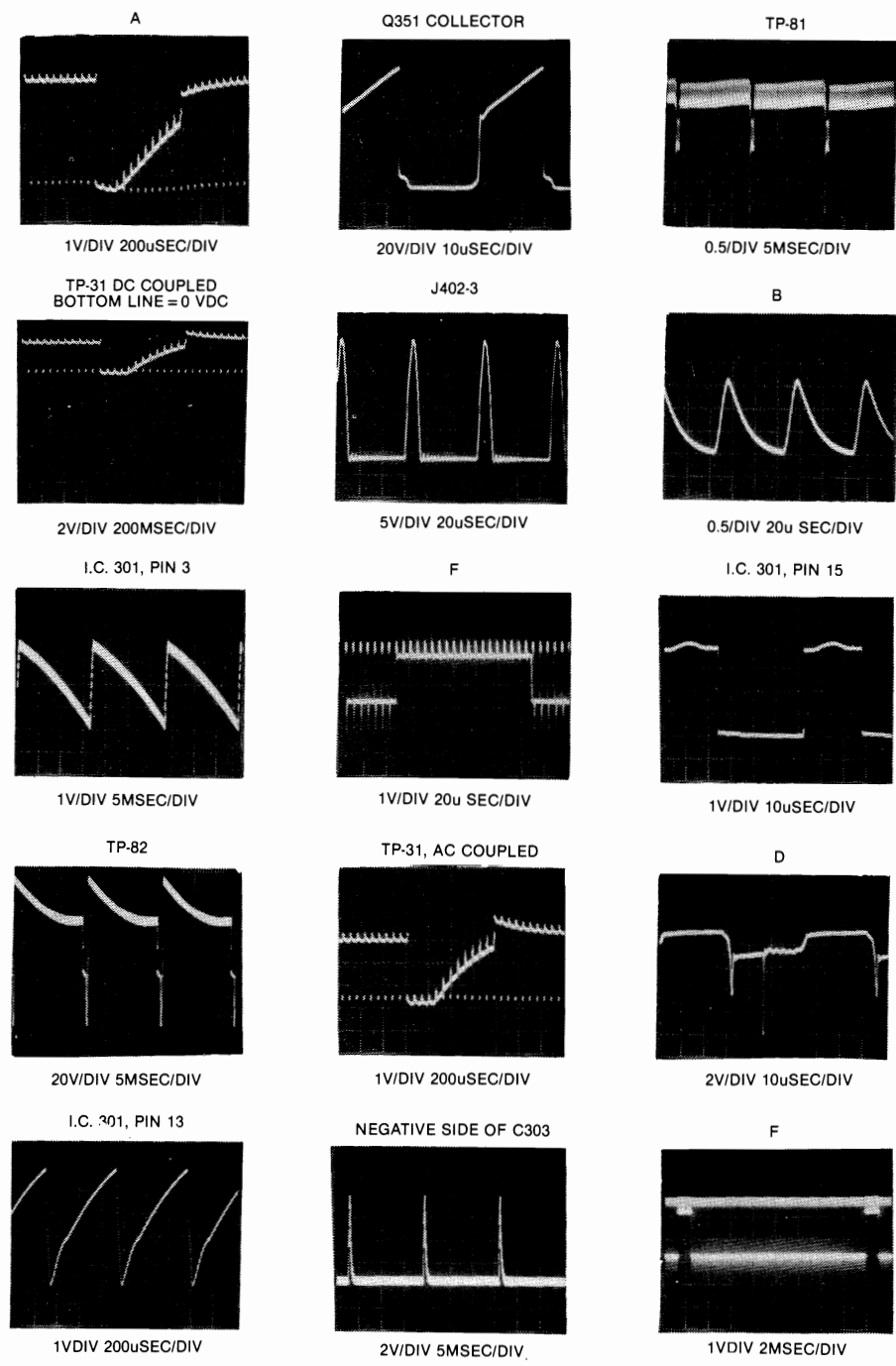

★ K4901D, K4906D, K4951D 5833  
K4956B

# LIMITED WARRANTY

D. Gottlieb & Co. warrants to the initial purchaser of the D. Gottlieb & Co. machine that the items listed in the following schedule as installed and used in the original D. Gottlieb & Co. machine will for the applicable period set forth in the schedule, computed from the initial date of purchase from an authorized D. Gottlieb & Co. distributor, be free of defects in materials and workmanship:

## SCHEDULE

<u>GAME</u>	<u>ITEM</u>	<u>WARRANTY PERIOD</u>
Pinball	All Electronic Printed circuit boards	90 days
Pinball-Video	All Electronic Printed Circuit Boards	90 days
	Card Cage	90 days
	Television Monitor	30 days
Video	All Electronic Printed Circuit Boards	90 days
	Television Monitor	30 days

This Limited Warranty does not apply to any parts damaged in the course of handling or assembling by the customer or damage due to other than normal use or use in violation of instructions or reasonable practices, or further damaged in return shipment. This Limited Warranty is made only to the original customer, and is and shall be in lieu of all other warranties expressed or implied, and of all other obligations or liabilities on the part of D. Gottlieb & Co. and in no event shall D. Gottlieb & Co. be liable for any anticipated profits, consequential damages, loss of time, or other losses incurred by the customer in connection with the purchase or operation of D. Gottlieb & Co. machines or components thereof.

The registration card with each D. Gottlieb & Co. factory-wired machine must be filled in and returned to D. Gottlieb & Co. within ten days after date of purchase for this Limited Warranty to be effective. This Limited Warranty applies only to machines so registered.

THIS LIMITED WARRANTY IS IN LIEU OF ANY OTHER EXPRESS OR IMPLIED WARRANTIES, INCLUDING ANY IMPLIED WARRANTY OF MERCHANTABILITY OR FITNESS, AND OF ANY OTHER OBLIGATION ON THE PART OF THE SELLER AND D. GOTTLIEB & CO.

 **Gottlieb**<sup>™</sup>  
**AMUSEMENT GAMES**

**Gottlieb**<sup>TM</sup>  
**AMUSEMENT GAMES**

165 W. Lake Street Northlake, IL 60164  
(312) 562-7400 Telex 72-8463

A Columbia Pictures Industries Company 