

JOHNNY NERO **ACTION HERO**



OWNERS AND SERVICE MANUAL **INNOVATIVE CONCEPTS IN ENTERTAINMENT INC.**

10123 MAIN STREET, CLARENCE, NY 14031

SERVICE: 1-716-759-0360

FAX: 1-716-759-0884

E-MAIL: service@icegame.com

WEBSITE: www.icegame.com



OWNERS AND SERVICE MANUAL

JOHNNY NERO : ACTION HERO™

© Innovative Concepts in Entertainment Inc.
10123 Main Street, Clarence, NY 14031

Table of Contents

CHAPTER 1 – SAFETY AND WARNINGS	4	Minimum Game Time	17
CHAPTER 2 – DEDICATED GAME		Game Volume	17
INSTALLATION	5	Lock Western Level	17
Hard Drive Installation	5	Gun Clackers	17
Power-Up	6	Control Switches	17
System Test	6	Volume Up	17
Game Setup	6	Volume Down	17
CHAPTER 3 – KIT INSTALLATION	7	Diagnostics Button	17
Getting Started	7	CHAPTER 5 – DIAGNOSTIC, ADJUSTMENT	
Cabinet Selection	7	AND AUDIT MENU SYSTEM	18
Power Requirements	7	Menu System	18
Monitor Requirements	7	Starting The Menu System	18
Cabinet Preparation	8	Navigating The Menu	18
Control Panel Installation	8	1.0 Main Menu	19
Button Preparation	8	1.1 System Test Menu	19
Gun Holster Preparation	9	1.2 View Game Audits	20
Graphic Overlay	9	1.3 View Coin Audits	24
Marquee Installation	10	1.4 Game Adjustments	25
Side Graphic Installation	10	1.5 Coinage Adjustments	26
Gun Installation	10	1.6 Clear Audits	26
Wiring and Hardware Assembly	12	1.7 Gun Calibration	27
Control Panel Assembly	12	CHAPTER 6 – TROUBLESHOOTING	28
Printed Circuit Board Installation	12	CAUTION	28
Hard Drive Installation	13	Game Is Non-Functional	28
Wire Harness	15	Monitor Is Non-Functional	29
Sync	15	Sound Is Non-Functional	29
Coin Doors, Test Switch & Service Button	15	Game Controls Are Non-Functional	29
Final Check	15	Marquee Lamp Is Non-Functional	29
Monitor Type Setting	15	JAMMA Harness Connection Table	30
CHAPTER 4 – GAME SETUP AND FEATURES	16	CHAPTER 7 – PARTS	31
Player Controls	16	CHAPTER 8 - WARRANTY	32
Start Button	16		
Guns	16		
Game Setup	17		
Coins	17		
Gun Calibration	17		
Difficulty Setting	17		

Chapter 1 – Safety and Warnings

BEFORE YOU BEGIN

WARNING: WHEN INSTALLING THIS GAME, A GROUNDED A.C. RECEPTACLE MUST BE USED. FAILURE TO DO SO COULD RESULT IN INJURY TO YOURSELF OR OTHERS. FAILURE TO USE A GROUNDED RECEPTACLE COULD ALSO CAUSE IMPROPER GAME OPERATION, OR DAMAGE TO THE ELECTRONICS

DO NOT DEFEAT OR REMOVE THE GROUNDING PRONG ON THE POWER CORD FOR THE SAME REASON AS GIVEN ABOVE. USING AN IMPROPERLY GROUNDED GAME COULD VOID YOUR WARRANTY.

HAVE A QUALIFIED ELECTRICIAN CHECK YOU'RE A.C. RECEPTACLE TO BE SURE THE GROUND IS FUNCTIONING PROPERLY.

HARD DRIVE - CAUTION

1. Hard drives are sensitive to electrical and physical shock – handle very carefully.
2. In both a dedicated game and kit, the hard drive is packaged in a box during shipment. Keep the original shipping box for shipping returns, if necessary.
3. Failure to use the supplied box will void the warranty.
4. DO NOT drop the hard drive.
5. DO NOT knock over the hard drive.
6. DO uninstall the hard drive from the game and place it in the supplied shipping box when moving the game. Moving or transporting the game with the hard drive installed will damage the hard drive make the game non-functional.

DO NOT REMOVE COMPONENTS

DO NOT remove any of the components on the main board (e.g. hard drive and eproms) while the game is powered on. This may cause permanent damage to the parts and the main board. Removing any main board component part while powered on will void the warranty.

Chapter 2 – Dedicated Game Installation

Hard Drive Installation

This game requires a hard drive. Hard drives are very sensitive to electrical and physical shock. Prior to turning the game on the first time, the hard drive must be installed.

1. Locate the hard drive. The hard drive is located in a box at the bottom of the cabinet. Remove the hard drive from the box and keep the box in the bottom of the cabinet.
2. Install the hard drive. Position the hard drive between the two flanges on the mounting bracket as shown in the photo below. Attach the hard drive using the four screws provided.
3. Attach the two wire harnesses to the hard drive as shown in the photo below.

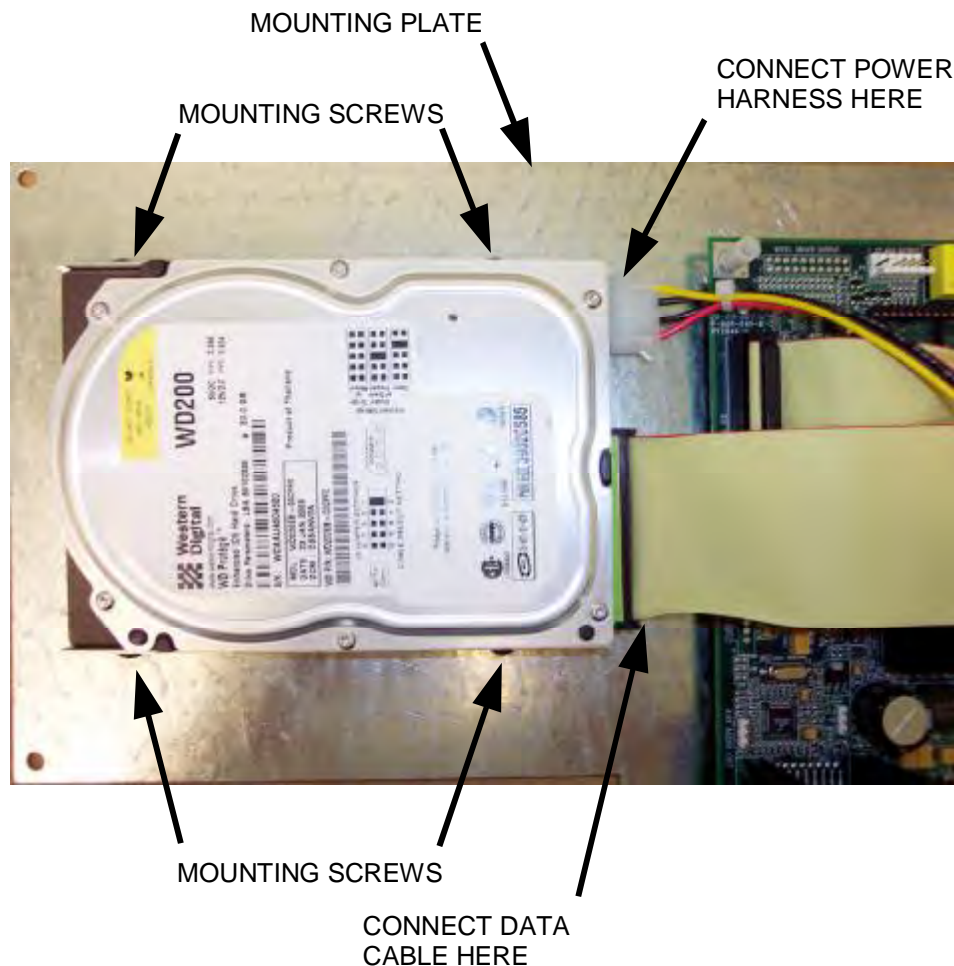

Power-Up

1. Plug the game into the A.C. outlet and turn on power to the game. The switch for the game is located on a power module on the outside rear of the game.

THIS GAME IS DESIGNED TO DISSIPATE STATIC ELECTRICITY THROUGH THE GROUNDING PLANE OF THE GAME. IF THE A.C. GROUND DOES NOT WORK, THE GAME COULD DISCHARGE STATIC ELECTRICITY THROUGH THE GAME CIRCUITRY, WHICH COULD CAUSE DAMAGE.

1. Make sure the game is level after installation. It is necessary to make sure the game is level for safety concerns.
2. Place the game into its final location and use the adjusting feet to level the game.
3. Check that the A.C. voltage rating on the back of the game matches the A.C. voltage of your location.

THE POWER SUPPLY IS NOT VOLTAGE ADJUSTABLE. TO OPERATE THE GAME AT VOLTAGES OTHER THAN THOSE IT WAS DESIGNED FOR, PLEASE CONTACT OUR SERVICE DEPARTMENT FOR VOLTAGE CONVERSION INFORMATION.

System Test

The game has a startup diagnostics mode in order to test game component and switch integrity. To start the diagnostics test, hold the Start button down during power-up. This test will perform a series of diagnostic tests. During the switch test, the operator must exercise the inputs to test switch integrity. Press the Start button to skip from test to test.

Game Setup

See Chapter 4 – Game Setup and Features to learn how to customize the game for your location. The gun MUST be calibrated before playing the game.

Chapter 3 - Kit Installation

GETTING STARTED

IMPORTANT: Your game must meet JAMMA standards or have provisions for JAMMA harnessing in order to use this kit.

REQUIRED TOOLS & SUPPLIES:

Phillips and Square Drive Screwdrivers	Wood Awl
Security Hex Allen Wrench	Wood File
Socket Set, Wire Cutters and Strippers	Razor Knife and Sharp Blades
Pliers or Channel Locks	Soldering Iron & 60/40 Resin Core Solder
Electric Drill with 3/16", 7/32", 1" and 1 1/2" Bits	Assorted Fastening Hardware
Chassis or Sheet Metal Punch	Heat Shrink Tubing (3/32", 1/8" and 3/16")
	Wire Ties

CABINET SELECTION

A new or used game cabinet may be used to install your **ACTION HERO™** game kit. Utilizing an existing cabinet is most cost effective. Whether you use a new or used cabinet, all that is required to install this kit is a power supply, monitor, bill acceptor and the cabinet. The kit includes all of the remaining components needed to complete the game conversion. When completed, you will have a new game at a substantial cost savings over a new game.

When choosing a cabinet, it is very important that the monitor be 25" or greater and mounted at a right angle to the front of the cabinet, to obtain the best results. For optimized game play, the monitor should be perpendicular to the guns.

THE CABINET

POWER REQUIREMENTS

Make sure the cabinet and power supply is able to supply the required voltages and current needed to run **ACTION HERO™**.

+5VDC @ 6 Amps (min)
-5VDC @ 0.1 Amps (min)
+12VDC @ 3 Amps (min)

MONITOR REQUIREMENTS

ACTION HERO™ requires a monitor with a horizontal mount raster scan with a negative composite sync.

ACTION HERO™ can operate on either low resolution (15KHz HScan) or medium resolution (25KHz HScan) monitors. See the DIP Switch Settings section of this manual to determine how to set-up the game to run on the selected monitor resolution.

Caution! Monitors can be extremely dangerous and improper handling can result in severe injury or even worse, death.

Be sure to follow all safety precautions as outlined in your monitor's manual.

Cabinet Preparation

CAUTION! Remove all power to the game before proceeding.

1. Begin by removing the following components from the cabinet:
Printed Circuit Boards (Main Board(s))
Control Panel
Marquee Graphics
Cabinet Graphics
2. Remove all the old buttons, joysticks and wires from the Control Panel. **DO NOT** remove any monitor or speaker wires.
3. Switches or buttons may have to be installed to the inside of the cabinet, if they do not already exist. They will be required for volume control, diagnostics & testing modes.
4. Remove the existing graphics from the control panel and the sides of the cabinet. Be sure to remove any remaining adhesive.

CONTROL PANEL

Overlay the Control Panel Decal from the kit on your existing Control Panel to determine it's best position. Keep in mind that mounting holes for the Gun Holsters and Start Buttons will have to be drilled in the Control Panel. A suggested pattern is shown below.

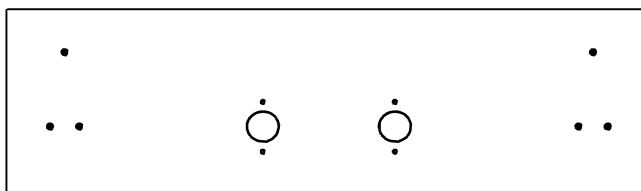

Start Button Preparation

ACTION HERO™ comes with 2 illuminated Start Buttons. When making the holes for the start buttons, use the control panel layout diagram as a guide to where you should drill your new holes, and mark the centers of the holes with a pencil.

Position and attach the Start Button Hole Pattern Templates to your control panel. Be sure that the locations you have chosen are free from obstructions inside the cabinet. Be sure that the templates are oriented correctly.

Carefully drill and deburr the two 1" center holes and the four 3/16" mounting holes.

Gun Holster Preparation

Position and attach the Gun Holster Hole Pattern Templates to your control panel. Be sure that the locations you have chosen are free from obstructions inside the cabinet. Be sure that the templates are oriented correctly. Carefully drill and deburr the six 1/4" mounting holes.

GUN HOLSTER MOUNTING TEMPLATE

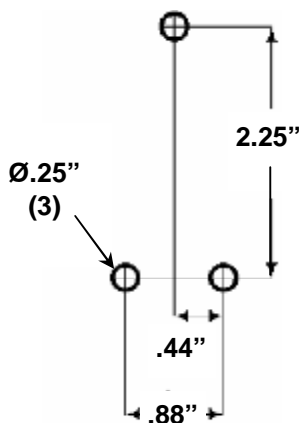

GRAPHIC OVERLAYS

ACTION HERO™ comes equipped with graphics that will accommodate a variety of existing game cabinets. Remove any old control panel graphics and make sure the panel is clean and free of dirt, grease or adhesives before installing your new graphics.

Control Panel Overlay Installation

1. Make sure the control panel is clean and free from dust, grease, metal filings and sawdust. The background overlay provided with the game is oversized to accommodate most control panel sizes. Center the background overlay on the control panel surface. Be sure to leave enough excess material above and below the control panel in order to trim it evenly.
2. Remove the protective backing from the background overlay. Center the background overlay over the control panel and place down gently, making sure to keep it square. Using your hands, press down firmly, starting from the center and smooth the background overlay outward, making sure all bubbles have been pressed out for a clean, flat surface.
3. Using a sharp razor knife, trim any excess from the background overlay. Carefully pierce through the overlay. Cut out material covering the pre-drilled holes with the razor knife. Be sure to cut and trim the background overlay cleanly and evenly.
4. It is highly recommended that you protect your control panel with a Plexiglas overlay. Cut it to fit and install now. Carefully transfer the mounting holes to the Plexiglas overlay and drill thru. Remove all burrs and sharp edges from the holes as well as the outside edges.
5. Insert the start buttons into the control panel and attach the two gun holsters. Be sure to tighten all bolts securely. Refer to the Wiring section of this manual for correct button wiring.

Marquee Installation

If your cabinet needs a new marquee glass, determine the correct size and cut to fit. Using the old marquee glass as a template, center the Plexiglas on your new marquee, making sure that all the printed images will be visible.

Using a razor knife, score the new marquee deeply, following the edges of the old glass. Carefully break off excess material. Be sure the light behind the marquee works and that the glass is clean on both sides. Now install the marquee graphics and glass securely.

Side Panel Overlay Installation

Carefully remove the backing from the supplied logo stickers and smooth in place on the side of your cabinet. Refer to the diagram below for optimal placement.

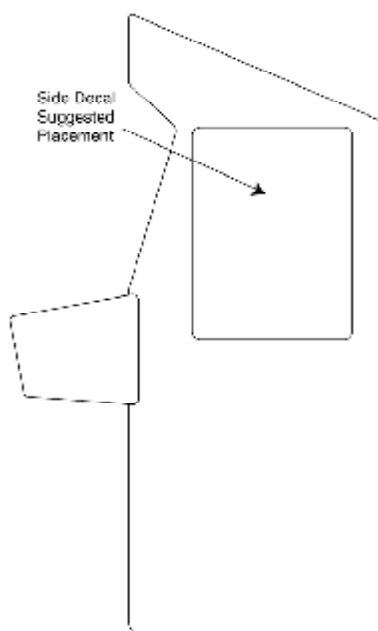

Preferred Side Graphics Layout

GUN INSTALLATION

Insert a gun into one of the newly mounted holsters. The attached gun cable should be hanging freely, with no loops or kinks.

Determine the best location for the gun cable-mounting bracket. Players should be able to move the gun freely. Use the diagrams shown in this manual for suggested locations. Be sure that once installed, the wires from the gun cable assembly will reach the power supply and PCB inside the cabinet.

Position and attach the Gun Mounting Template to the cabinet. Be sure that the location you have selected is free from bracing or wiring inside the cabinet.

Carefully drill and deburr the 1 ½" center hole and the three 7/32" mounting holes.

Thread the cable connector and grounding wire through the center hole.

Mount the Gun Cable Mounting Plate using the supplied carriage bolts, flat washers and locking nuts. Make sure the bolts are firmly seated. Attach the grounding wire to any one of the carriage bolts before installing the washer and locking nut.

Repeat procedure for the second gun.

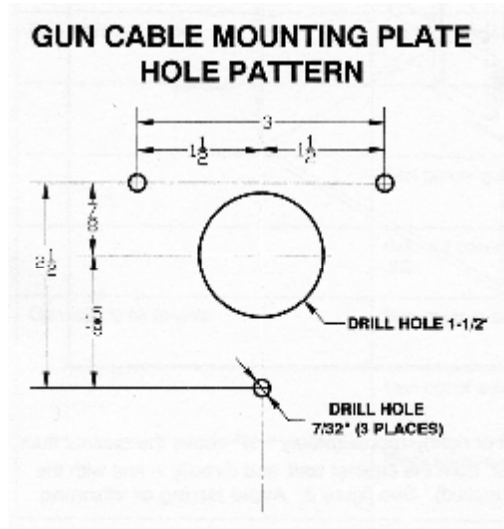

Once the Gun Cable Mounting Plates are mounted securely, make sure that the guns can move freely in all directions.

Inside the cabinet, connect the Cable Connector to the supplied Connecting Harness. The Connecting Harness then connects to the GUN 1 & GUN 2 connectors on the main PCB. See the Wiring section of this manual for more details.

Front View Of Game

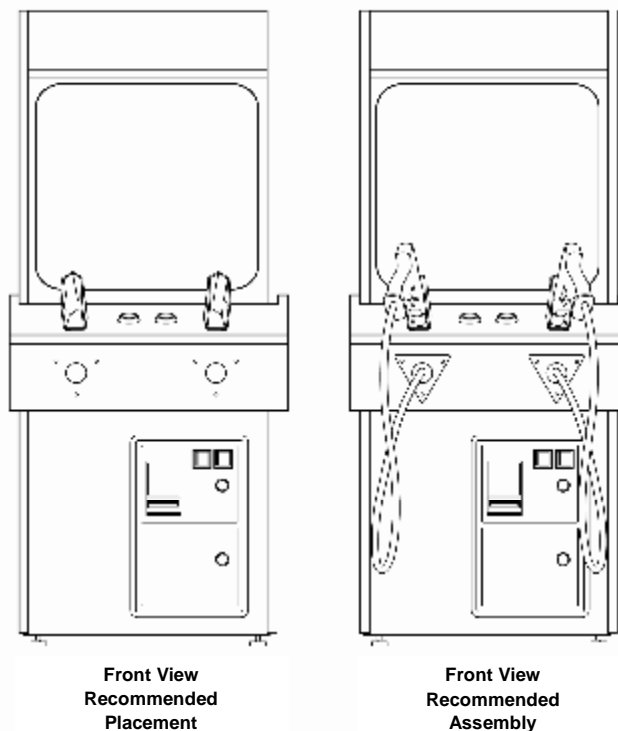

WIRING AND HARDWARE ASSEMBLY

REMEMBER! DO NOT WORK WITH ANY PART OF THIS SYSTEM PLUGGED IN (Lights, Monitor or Power Supply).

NOTE:

All switch wires used in this game need to be wired to the normally open connection on the switches. Each switch requires a ground wire on the common connector and the appropriate control or switch wire on the other normally open connector of the switch.

Final Assembly

1. If you are using Plexiglas for added protection, don't forget to place it on the panel before inserting the Start button.
2. Install the guns and Start buttons on the control panel by following the detailed instructions beginning on page 8.
3. Using supplied Gun Harness, connect Player 1 Gun Cable to "Gun 1" (6 wires) of Gun Harness, "Gun 2" to Player 2 Gun.
4. Run Gun Harness through cabinet.
5. Locate a flat & level surface to mount PCB Assembly Tray.
6. From the Gun Harness, plug "Gun 1" (4 wire) to Gun 1 connector on PCB. Repeat for "Gun 2". (4 wire)
7. Mount PCB Tray Assembly.
8. Connect the main PCB to the coil PCB using the Coil PCB Input harness (Aux Output of main PCB to P2 of Driver board)
9. Connect the gun harness to the coil PCB (P1)
10. Using the 4 supplied dry wall screws, secure the coil PCB to the cabinet.
11. Connect the Coil PCB to the 24V Power supply using the Coil PCB Power Harness (Purple and Black Wires). (P3 Connector). **NOTE: Be sure the Purple Wires are connected the +24V and the Black to 0V.**
12. Mount the power supply to the cabinet.
13. Connect the power supply to 110Vac Main Voltage using the supplied power cable. **NOTE: Be sure the Brown is Line, Green/Yellow is Earth Ground, and Blue is Neutral.**
14. Plug the JAMMA Connector into the main PCB.

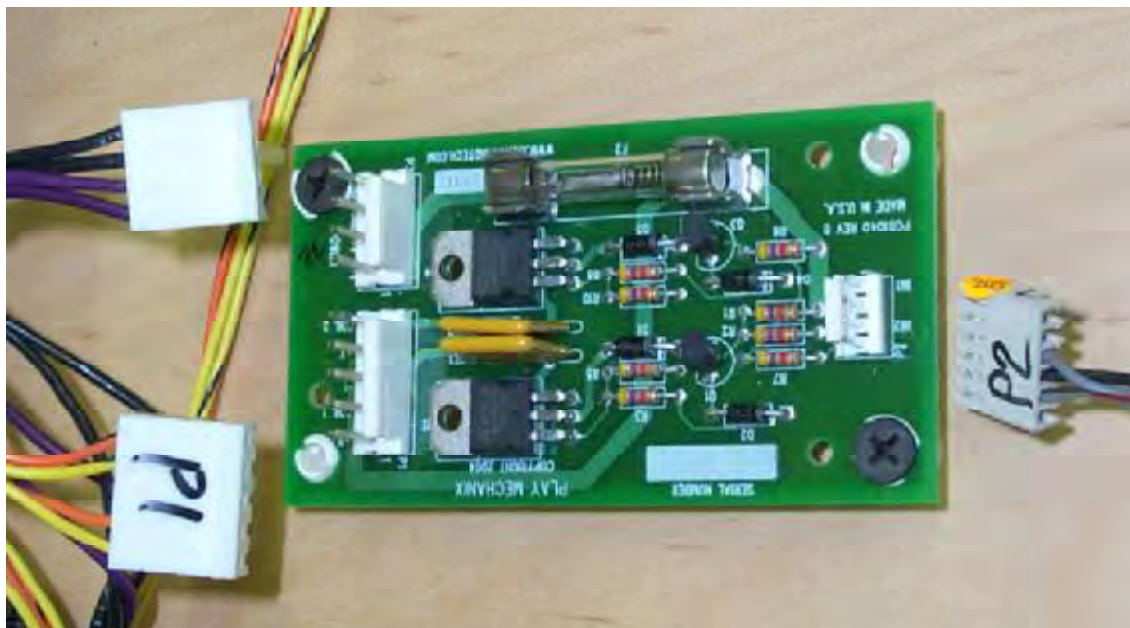

Printed Circuit Board (PCB)

ACTION HERO™ uses a hard drive to store its game data. The hard drive and PCB are mounted to a plate, which allows for easier assembly and placement. Refer to the next section for suggested mounting locations.

PCB and Hard Drive Installation

The Hard Drive is shipped in a specially padded box for maximum protection. Be sure to keep this box, in case you need to ship the hard drive. Failure to use the supplied box will VOID THE WARRANTY on the hard drive.

The PCB and the Hard Drive are both mounted to a single mounting plate, making installation and placement easier. The PCB is pre-assembled to the mounting plate.

To begin installation, remove the mounting plate & PCB Assembly from the shipping container. Next remove the Hard Drive from the protective box. (Save this box - this box must be used in the event that the Hard Drive has to be returned)

Remove the four mounting screws from the Hard Drive. At this time, connecting the required harnessing is recommended. Harness installation will be easier with the Hard Drive unattached from the mounting plate. (See photos for harness connections)

Position the Hard Drive between the two flanges on the mounting plate. Attach the Hard Drive to the plate using the four screws previously removed.

CAUTION!

Hard drives are sensitive to both physical and electrical shock. DO NOT DROP OR KNOCK OVER the hard drive. Avoid shocks and other electrical discharges.

Keep the supplied padded box for shipping any returns. Failure to use the supplied shipping box will void the warranty.

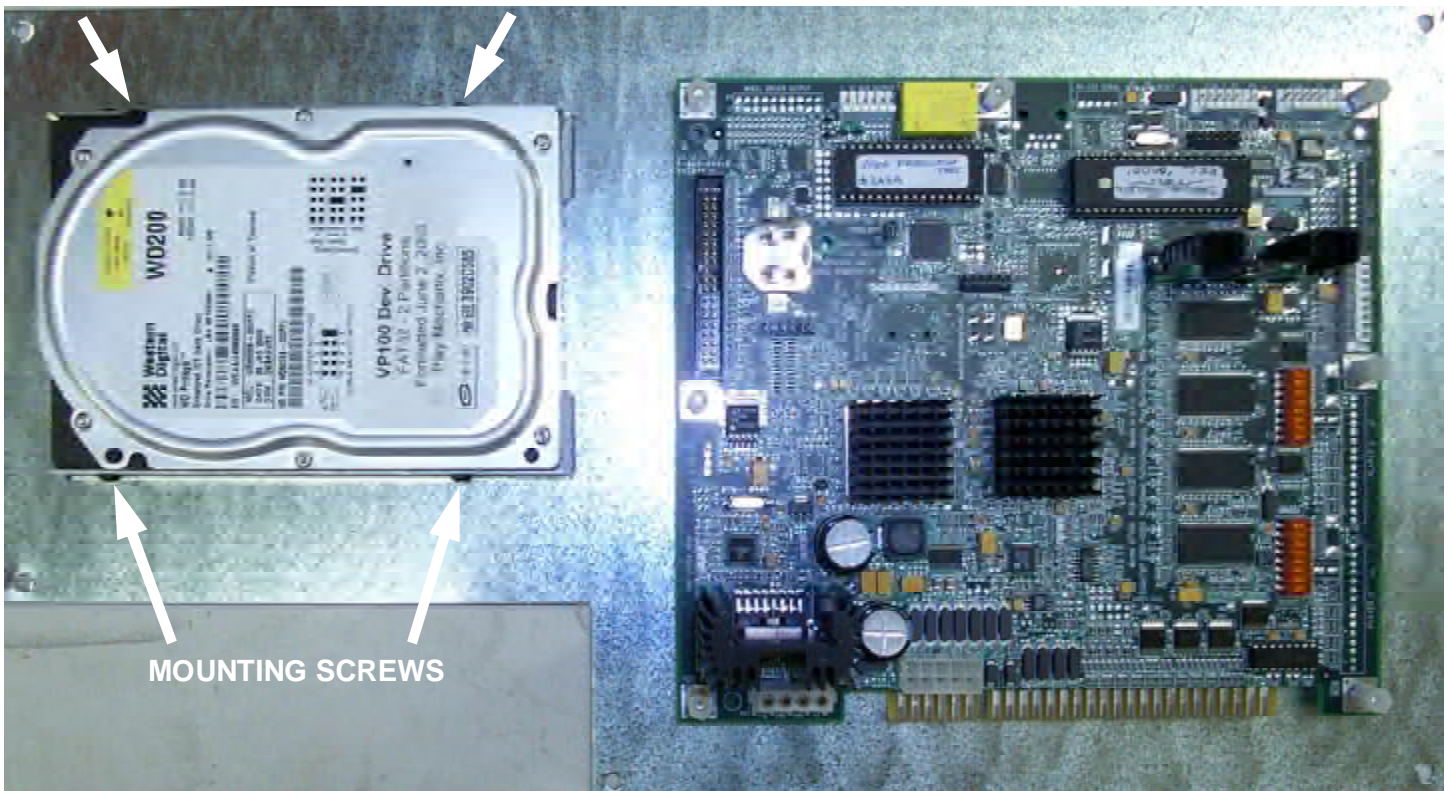

Data and Power Bypass cables are supplied in this kit. The ribbon Data Cable for the hard drive is required for proper operation. The Power Bypass Cable is used to supply power to the hard drive. See the photo below for proper installation.

The supplied ribbon Data Cable is for data transmission. Connect one end of this cable to the keyed connector at J21 on the game board, and the other end into the keyed connector on the hard drive. See the photo below for proper installation.

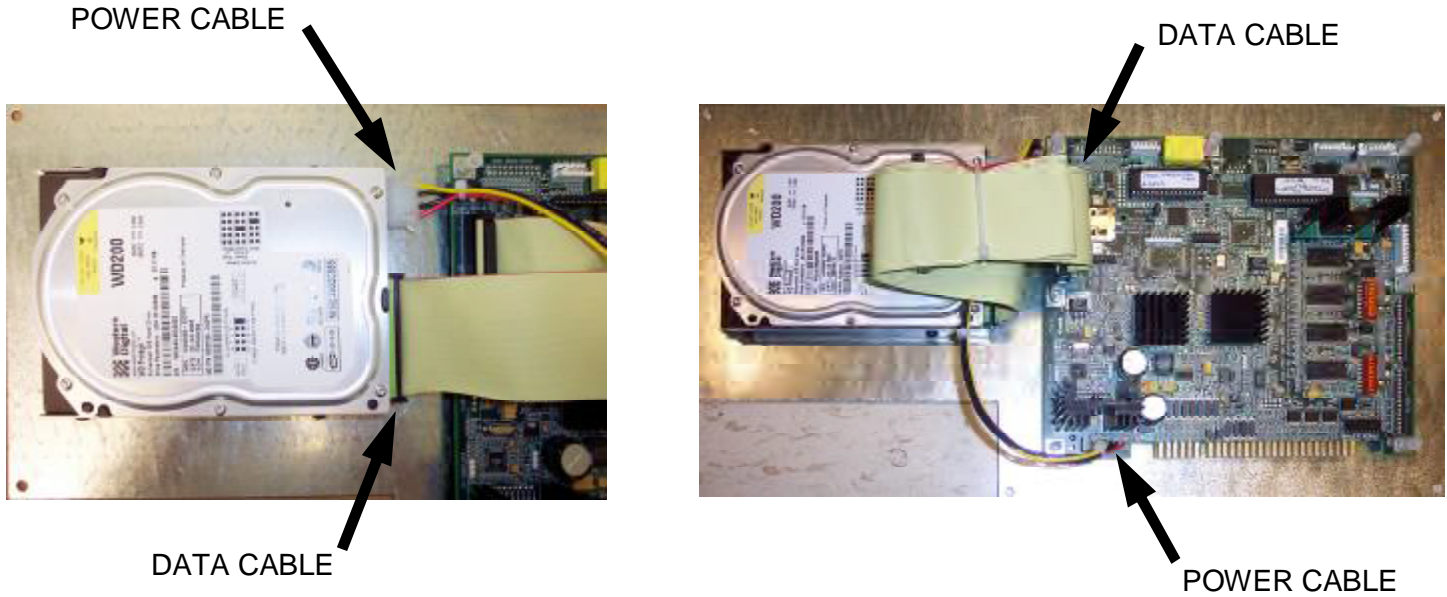

Installation in Lower Cabinet

Choose a flat surface in the game cabinet to attach the PCB and Hard Drive mounting plate. The mounting can be mounted horizontally or vertically. Do not mount on an inclined surface. Attach the mounting plate to the cabinet using the five screws provided. Before attaching mounting plate, be sure that the location chosen will allow the wire harness from the gun assembly to reach the PCB.

Returns

In kit games, the hard drive is shipped in a special padded box. Be sure to keep this box, in case you need to ship the hard drive. Failure to use the supplied box will VOID THE WARRANTY on the hard drive.

Wire Harness

1. If you are installing **ACTION HERO™** into a cabinet with a pre-installed JAMMA harness, it may not have a wire for the test switch. You will have to add a contact to the edge connector at the proper position (position 15). Some cabinets have only one coin switch input and the coin switches are wired together. Connect the designated wires to the coin switches separately.
2. Attach the wire harness connector to the PCB. Be sure it is mounted correctly.

WARNING!

Make sure you have identified PIN 1 on the connector before powering up. Plugging the JAMMA connector in backwards will cause damage to the PCB.

3. It is best to use connectors (not supplied) whenever joining a set of harness wires to a subassembly. If you choose to solder wires together, follow this procedure:
4. Strip off about ½" of insulation from the wire.
5. Slide a piece of heat shrink tubing over the end.
6. Do not leave a lot of excess wire spooled up in your cabinet. Cut the wires to the length you need plus a few extra inches. Leave enough for proper cable dressing. Do not make it stretch across the inside of the cabinet.
7. Solder the new wire to the original wire. Use a straight in-line splice.

SYNC

This is the recommended approach for a Wells-Gardner monitor and should work with some others as well.

If your monitor does not have a composite SYNC input but has separate horizontal and vertical SYNC inputs, try connecting the composite SYNC signal from the PCB to the negative horizontal SYNC signal on the monitor. This should produce a satisfactory result, although some adjustment of the monitor's SYNC controls may be necessary.

Coin Doors, Test Switch & Service Button

Wire the coin doors and the test / service switch (es) as per the JAMMA Harness Connection table on page 30. Connect the door lamps to the +12 vdc supply. Some games have separate power supply outputs for the lamps.

Install a test switch somewhere convenient inside the coin door area. This switch allows you to enter adjustables, run diagnostics and see or clear audits. Make it readily accessible through the coin door. Wire it to the Test wire on the JAMMA Harness.

Install a service switch (not included) somewhere convenient inside the coin door area. This switch allows you to give credits to players without affecting the game's credit audits or coin meters. Example: A player puts in a coin and gets no credit, the operator can then push the service button and a credit is given to the player without affecting the game's audits and coin meter.

Final Check

Check the game inside and out for any imperfections. Secure any loose wiring or fastening hardware.

Make sure the coin door is tight and the coin mechs are well adjusted.

NOTE:

Make sure all assemblies are firmly Attached. Anything that is not mounted securely will rattle when the game is played. This game makes use of low-frequency sounds, which can cause any loose joints to rattle.

Monitor Type Setting

Refer to the photo below for setting the DIP switch on the Main PCB for the type of monitor you are using in your game.

DIP Settings for Low or Medium Resolution should be:

Low Resolution: DIP S1 and S2 ALL OFF

Medium Resolution: DIP S1 and S2 - ALL OFF except S1 #6 ON



DIP S1

Chapter 4 – Game Setup and Features

Game Overview

In Action Hero, the player takes on the persona of Johnny Nero. Johnny is a comic book hero that plays in three very different 3-dimensional worlds.

Space Wars – An evil alien empire is at war with the human race. Johnny Nero is all that stands between them and our total annihilation. Includes 3 bosses, 2 extreme action bonuses and 10 unique enemy types.

Curse of The Mummy King – Johnny battles hordes of Egyptian evil enemies and an ancient Pharaoh to recover the priceless Jewel of Amon-Ra. Includes 3 bosses, 2 action extreme bonuses and 12 unique enemy types.

Ghost Town – Johnny is a gun for hire paid to clean out the evil sheriff and his gun slinging hordes of undead. Includes 4 bosses, 2 action extreme bonuses and 8 unique enemy types.

1 or 2 Player Simultaneous Play – Game can be played by 1 or 2 players simultaneously.

Guns of Fury Mode – A player can play the game using two guns at once. Player picks this mode or the standard 1 or 2 player mode at the start of the game.

Adrenaline Rush Mode – Throughout the game, the player's Adrenaline Rush meter increases and decreases. Once the meter reaches full, the player enters Adrenaline Rush Mode. During Adrenaline Rush, the game goes into a hyper frenzy and the player gets unlimited ammunition with a devastating rocket launcher that destroys enemies in a single shot. Once achieved, Adrenaline Rush lasts for approximately 15 seconds. Adrenaline Rush Mode is like Turbo In a driving game.

Power Ups – Look for power-ups out in the open and in secret and hidden places

Extra Life – increases player life

Shotgun – 5 shots at once

Shrink Ray – shrinks all enemies into oblivion

Flame Thrower – incinerates enemies into a pile of embers

Sticky TNT – embeds a bundle of dynamite to a enemy and blows them to smithereens

Other

Low AND Medium Resolution Monitors Supported

Player Controls

Start Buttons

The Start buttons are used to start a game once the proper number of credits have been inserted. The Left Start button is also used to select or accept entries in the diagnostics system.

Guns

The guns are used to shoot targets throughout the game. The guns are also used to navigate the menu in the diagnostic system.

Game Setup

The game is setup at the factory with the recommended factory settings. The following outlines the important adjustments an operator may adjust during initial game setup. For more detailed instructions on setting these adjustments, see Chapter 5.

Coins

Set the number of credits required to start and continue the game. Action Hero has two play modes: Standard Play and Guns Of Fury. The credits to start and continue may be different for each play mode. In Standard Play, one or two players can play simultaneously like most two player gun games. Set the credits to start and continue accordingly. In Guns of Fury mode, one player uses both guns at once. For this mode, we recommend setting credits to start and continue at 50% greater than the Standard Play mode.

Also set the number of credits given for each coin inserted in the coin mechanisms and the DBV. These settings are adjusted in the COINAGE ADJUSTMENTS menu.

Gun Calibration

Whenever installing the game in a new location, the two guns must be re-calibrated. The guns can be calibrated in the GUN CALIBRATION menu.

Difficulty Setting

Set the difficulty level of the game to 'EASY', 'MEDIUM', or 'HARD'. This setting determines how many enemies appear on screen at once and how aggressive they will be. As the difficulty setting increases, the average game time will decrease.

Minimum Game Time

Minimum Game Time determines the minimum amount of time a player will 'live' for each new buy-in. As the Minimum Game Time increases, the average game time per play will also increase.

Game Volume

The game has two volume settings. One setting is for the volume of the game during game play. The other setting for the volume of the game while in the attract mode.

Lock Western Level

If the West is UNLOCKED, a player may choose this comic at any time. If the West is LOCKED, a player must complete the Space and Mummy comics in order to unlock the West comic.

Gun Clackers

Action Hero comes with a special driver board that will drive the recoil guns. If Gun Clackers is ON, the guns will recoil during game play. If Gun Clacker is OFF, the guns will not recoil.

Control Switches

The control switches are located inside the front coin door.

Volume Up

Press the volume up button to increase the volume. Pressing this button when playing the game will increase the game volume. Pressing this button when the game is in the attract mode will increase the attract mode volume.

Volume Down

Press the volume down button to decrease the volume. Pressing this button when playing the game will decrease the game volume. Pressing this button when the game is in the attract mode will decrease the attract mode volume.

Diagnostics Button

Press this button to go into the diagnostics MAIN MENU.

Chapter 5 – Diagnostic, Adjustment and Audit Menu System

Menu System

The game's menu system is a series of on screen menus that allow the operator to setup and adjust the settings. Many menu items lead to another menu, a list of data or provides the ability to modify the adjustment.

Starting The Menu System

Press the Diagnostics control switch inside the coin door to access the on screen menu system.

Navigating The Menu

Use the following to navigate the menu system:

- Left gun trigger to move the cursor down the menu or to decrease a selectable value
- Right gun trigger to move the cursor up the menu or to increase a selectable value
- Use the Left Start button to select an item. On selectable menu items, press the Left Start button to activate the adjustable. Once activated, use the Left or Right gun triggers to change the settings. Once an item has been changed, press the Left Start button to save the desired setting.

1.0 Main Menu

All system tests, audits and game adjustments are accessible from the MAIN MENU.

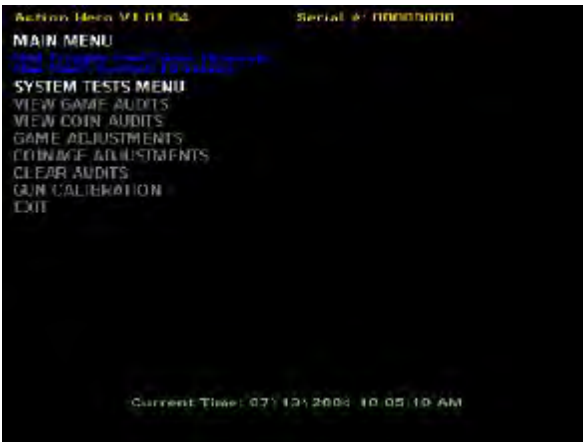

1.1 System Test Menu

Select SYSTEMS TEST at the MAIN MENU.

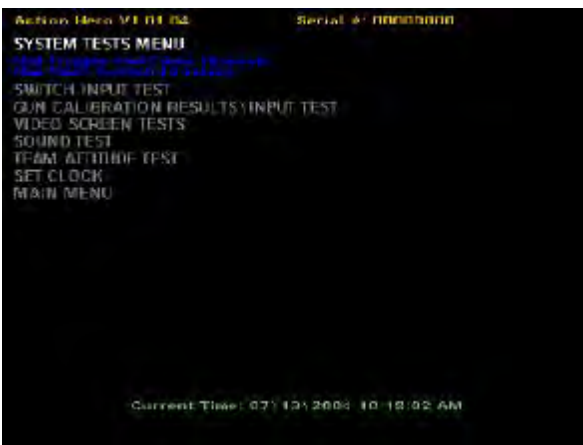

Switch Input Test - Select SWITCH INPUT TEST to manually test all of the switch inputs. When in this screen, activate the start button, test button, volume up, volume down, coin 1, coin 2, coin 3, coin 4, shotgun trigger and shotgun pump to determine if the game recognizes input from each.

Gun Calibration Results\input Test - Select to test the results of the gun calibration.

Video Screen Tests - Select VIDEO SCREEN TESTS to test: Color and Screen Size

Sound Test - Select SOUND TEST to test various game sounds and songs.

Team Attitude Test - Select TEAM ATTITUDE TEST to determine the attitude of the development team.

Set Clock - Select SET CLOCK to set the current time. This time is used to indicate when certain settings have changes like AUDITS RESET.

1.2 View Game Audits

Select VIEW GAME AUDITS at the MAIN MENU to view import audit data about the game. Use the Shotgun trigger and pump to navigate through the page navigation items at the bottom of each page. All of these game audits will be reset to zero each time RESET AUDITS or RESTORE FACTORY SETTINGS is performed.

Page 1

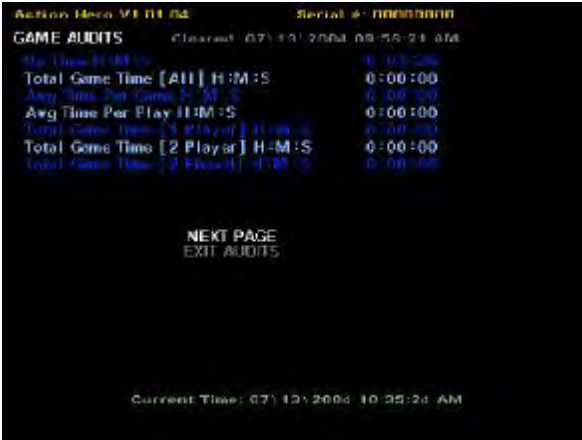

Up Time H:M:S - Total up time. Reported in Hours, Minutes and Seconds.

Total Game Time H:M:S – Total time. Reported in Hours, Minutes and Seconds.

Avg Time Per Game H:M:S – Average amount of game time for each game played, including all initial buy-ins and continues. Reported in Hours, Minutes and Seconds.

Avg Time Per Play H:M:S – Average amount of game time per buy-in. Reported in Hours, Minutes and Seconds.

Total Game Time – 1 Player – Total game time for 1 player games.

Total Game Time – 2 Player – Total game time for 2 player games.

Total Game Time – 2 Fisted – Total game time for 2 Guns of Fury Mode games.

Page 2



Continues Offered – Number of player continues offered to players in a 1 or 2 player game.

Continues Taken – Number of player continues taken by players in a 1 or 2 player game.

Average Continue – Average number of continues taken.

Continues Offered – 2 Fisted – Number of player continues offered to players in a Guns of Fury game.

Continues Taken – 2 Fisted – Number of player continues taken by players in a Guns of Fury game.

Average Continue – 2 Fisted – Average number of continues taken in a Guns of Fury game.

Page 3

Metric	Count
Player Starts	0
Player Joins	0
Game Overs	0
Game Wins	0
Total Adrenaline Rushes	0
Player Starts [2-Fisted]	0
Game Overs [2-Fisted]	0

Player Starts All – Number of games started by players in all modes (1 player, 2 player, Guns of Fury)

Player Joins – Number of join-in while a game is in progress. Only applies to 1 player games.

Game Overs All – Number of game overs in all modes (1 player, 2 player, Guns of Fury)

Game Wins – Number of games won. A game win is defined as a player finishing all 3 comic books during one game.

Total Adrenaline Rushes – Number of times players achieved the Adrenaline Rush mode.

Player Starts 2 Fisted – Number of games started by players in the Guns of Fury mode only.

Game Overs 2 Fisted – Number of game overs in the Guns of Fury mode only.

Page 4

Metric	Count
Space Selected	209
Space Selected First	5
Mummy Selected	140
Mummy Selected First	4
Mummy Finished	4
West Selected	440
West Selected First	440
West Finished	5

Space Selected – Number of times the Space level was selected to play.

Space Selected First– Number of times the Space level was selected to play as the first comic in a new game.

Space Finished– Number of times the Space level was completed by a player.

Mummy Selected – Number of times the Mummy level was selected to play.

Mummy Selected First– Number of times the Mummy level was selected to play as the first comic in a new game.

Mummy Finished– Number of times the Mummy level was completed by a player.

West Selected – Number of times the West level was selected to play.

West Selected First– Number of times the West level was selected to play as the first comic in a new game.

West Finished– Number of times the West level was completed by a player.

Page 5

The screenshot shows a terminal window with the following content:

```
Action Hero VI 01 04 Serial #: 00000000
GAME AUDITS Clearcut: 07:10:2004 09:56:21 AM
GameOver Space SW1 0
GameOver Space SW2 1
GameOver Space SW3 0
GameOver Space SW4 0
GameOver Space SW5 0
GameOver Space SW7 0
NEXT PAGE
PREVIOUS PAGE
EXIT AUDITS
Current Time: 07:10:2004 10:27:37 AM
```

Game Over	Space SW	Count
GameOver	Space SW1	0
GameOver	Space SW2	1
GameOver	Space SW3	0
GameOver	Space SW4	0
GameOver	Space SW5	0
GameOver	Space SW7	0

Game Overs Space SW1 – Number of times a game over occurred in the 1st section of the Space comic.

Game Overs Space SW2 – Number of times a game over occurred in the 2nd section of the Space comic.

Game Overs Space SW3 – Number of times a game over occurred in the 3rd section of the Space comic.

Game Overs Space SW4 – Number of times a game over occurred in the 4th section of the Space comic.

Game Overs Space SW5 – Number of times a game over occurred in the 5th section of the Space comic.

Game Overs Space SW6 – Number of times a game over occurred in the 6th section of the Space comic.

Game Overs Space SW7 – Number of times a game over occurred in the 7th section of the Space comic.

Page 6

The screenshot shows a terminal window with the following content:

```
Action Hero VI 01 04 Serial #: 00000000
GAME AUDITS Clearcut: 07:10:2004 09:56:21 AM
GameOver Mummy SW1 0
GameOver Mummy SW2 0
GameOver Mummy SW4 0
GameOver Mummy SW6 1
GameOver Mummy SW7 0
NEXT PAGE
PREVIOUS PAGE
EXIT AUDITS
Current Time: 07:10:2004 10:27:58 AM
```

Game Over	Mummy SW	Count
GameOver	Mummy SW1	0
GameOver	Mummy SW2	0
GameOver	Mummy SW4	0
GameOver	Mummy SW6	1
GameOver	Mummy SW7	0

Game Overs Mummy SW1 – Number of times a game over occurred in the 1st section of the Mummy comic.

Game Overs Mummy SW2 – Number of times a game over occurred in the 2nd section of the Mummy comic.

Game Overs Mummy SW3 – Number of times a game over occurred in the 3rd section of the Mummy comic.

Game Overs Mummy SW4 – Number of times a game over occurred in the 4th section of the Mummy comic.

Game Overs Mummy SW5 – Number of times a game over occurred in the 5th section of the Mummy comic.

Game Overs Mummy SW6 – Number of times a game over occurred in the 6th section of the Mummy comic.

Game Overs Mummy SW7 – Number of times a game over occurred in the 7th section of the Mummy comic.

Page 7

Game Over Section	Count
GameOver West SW1	0
GameOver West SW2	4
GameOver West SW3	0
GameOver West SW4	0
GameOver West SW5	0
GameOver West SW6	0
GameOver West SW7	0

Game Overs West SW1 – Number of times a game over occurred in the 1st section of the West comic.

Game Overs West SW2 – Number of times a game over occurred in the 2nd section of the West comic.

Game Overs West SW3 – Number of times a game over occurred in the 3rd section of the West comic.

Game Overs West SW4 – Number of times a game over occurred in the 4th section of the West comic.

Game Overs West SW5 – Number of times a game over occurred in the 5th section of the West comic.

Game Overs West SW6 – Number of times a game over occurred in the 6th section of the West comic.

Game Overs West SW7 – Number of times a game over occurred in the 7th section of the West comic.

Page 8

Pass Section	Average Rate
Space EA1 Pass	0.50
Space EA2 Pass	0.10
mummy Spike Pass	0.00
mummy EA2 Pass	1.0
west GatGun Pass	0.10
west EA1 Pass	0.20
west EA2 Pass	0.10

Space Car Pass – Average number of times this bonus section was passed.

Space AE1 Pass – Average number of times this bonus section was passed.

Space AE2 Pass – Average number of times this bonus section was passed.

Mummy Spike Pass – Average number of times this bonus section was passed.

Mummy AE1 Pass – Average number of times this bonus section was passed.

Mummy AE2 Pass – Average number of times this bonus section was passed.

West GatGun Pass – Average number of times this bonus section was passed.

West AE1 Pass – Average number of times this bonus section was passed.

West AE2 Pass – Average number of times this bonus section was passed.

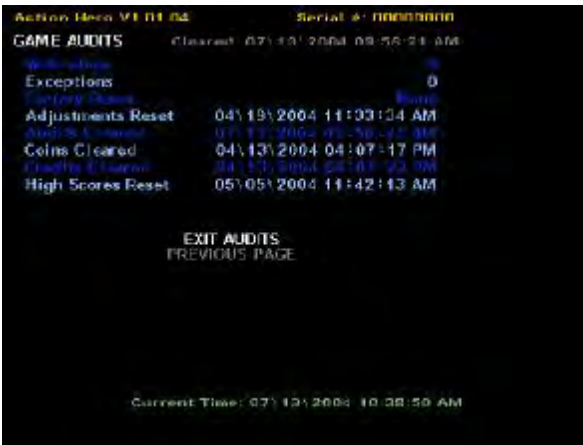

- Watchdogs** – Number of game resets due to watchdog
- Exceptions** – Number of game resets due to exceptions.
- Factory Reset** – Factory reset date.
- Adjustments Reset** – Adjustments reset date.
- Audits Cleared** – Audits cleared date.
- Coins Cleared** – Coins cleared date.
- Credits Cleared** – Credits cleared date.
- High Score Reset** – High scores reset date.

Note: The clock must be set for these dates to be valid. See SET CLOCK under the SYSTEMS TEST menu.

1.3 View Coin Audits

Select VIEW COIN AUDITS at the MAIN MENU to view coin data about the game.



- Coin 1** - Number of coins inserted in coin mechanism 1.
- Coin 2** - Number of coins inserted in coin mechanism 2.
- Bill Validator Uses** - Number of bills inserted in the DBV.
- Paid Credits** - Number of paid credits.
- Lifetime Coin Count** - Number of coins/bills inserted in all coin devices since the game has been installed. This counter may not be reset.

1.4 Game Adjustments

Select GAME ADJUSTMENTS at the MAIN MENU. Modify these game adjustments to change the way the game functions.



Difficulty – Set the difficulty level of the game to 'EASY', 'MEDIUM', or 'HARD'. This setting determines how many enemies appear on screen at once and how aggressive they will be. As the difficulty setting increases, the average game time will decrease.

Minimum Game Time – Minimum Game Time determines the minimum amount of time a player will 'live' for each new buy-in. As the Minimum Game Time increases, the average game time per play will also increase.

Lock West Level – If the West is UNLOCKED, a player may choose this comic at any time. If the West is LOCKED, a player must complete the Space and Mummy comics in order to unlock the West comic.

Gun Clackers On – If Gun Clackers is ON, the guns will recoil during game play. If Gun Clacker is OFF, the guns will not recoil.

Minimum Volume – Minimum volume setting for the game. Set from 0 – 255. The higher the setting the higher the volume.

Game Volume – Volume setting for the game. Set from 0 – 255. The higher the setting the higher the volume.

Attract Mode Volume – Volume setting for the attract mode. Set from 0 – 255. The higher the setting the higher the volume.

1.5 Coinage Adjustments

Select COINAGE ADJUSTMENTS at the MAIN MENU. Modify these coinage adjustments to change the price of the game.

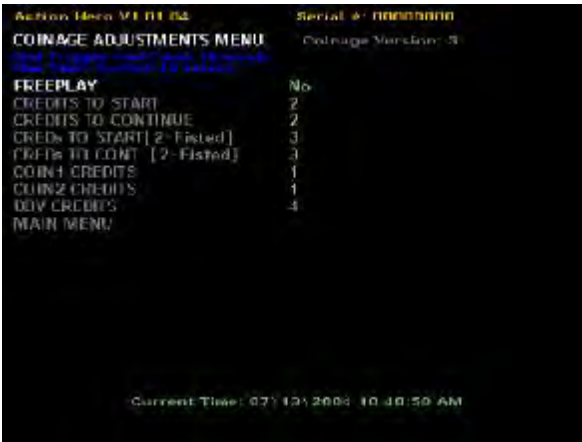

Free Play – If set to 'Yes' the game is set on free play and no coins or credits will be required to play.

Credits to Start – Set the number of credits required to start a game. Set from 1 – 25.

Credits to Continue – Set the number of credits required to continue a game. Set from 1 – 25.

Credits to Start – 2 Fisted - Set the number of credits required to start a Guns of Fury game. Set from 1 – 25.

Credits to Continue – 2 Fisted - Set the number of credits required to continue a Guns of Fury game. Set from 1 – 25.

Coin 1 Credits – Set the number of credits received when a coin or token is inserted in coin mechanism 1. Set from 1 – 50.

Coin 2 Credits – Set the number of credits received when a coin or token is inserted in coin mechanism 2. Set from 1 – 50.

DBV Credits – Set the number of credits received when pulse is received from the DBV. Set from 1 – 50.

1.6 Clear Audits

Select CLEAR AUDITS at the MAIN MENU. Modify these ticket adjustments to change the number of tickets dispensed by the game.

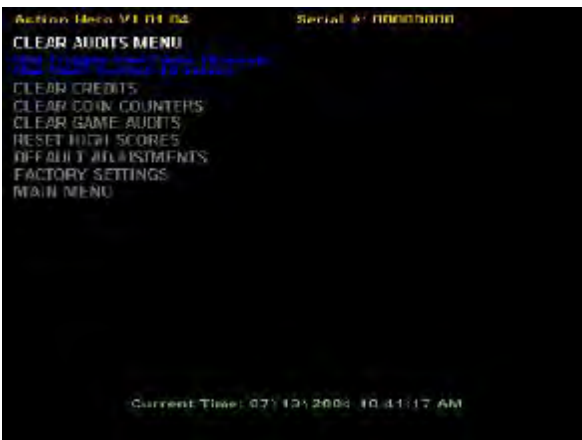

Clear Credits – This will clear the credits currently in the game.

Clear Coin Counters – This will clear all of the coin counters in the game.

Clear Game Audits – This will clear all the game audits.

Reset High Scores – This will reset the high score tables.

Default Adjustments – This will reset the game using all of the default adjustments.

SEE NEXT PAGE

Default Adjustments are as follows:

Game Adjustments:

Difficulty	Medium
Minimum Game Time	60 sec.
Lock West Level West	Unlocked
Gun Clackers	Gun Clackers On
Minimum Volume	30
Game Volume	220
Attract Volume	210

Coin Adjustments:

Freeplay	No
Credits to Start	4
Credits to Continue	4
Credits to Start GF	6
Credits to Continue GF	6
Coin 1	1
Coin 2	1
DBV	4

Factory Settings – This will reset the game using all of the default settings above and clear credits, game audits, coin audits and reset high scores. It will NOT reset the Lifetime Coin Counter.

1.7 Gun Calibration

Select GUN CALIBRATION at the MAIN MENU.



Gun Calibration – Select this to calibrate the guns. First, aim gun carefully at the dot in the upper left corner of the screen and slowly pull the trigger. Do the same for the two other dots placed on the screen.

Do this first for the Left Gun then the Right Gun.

Chapter 6 – Troubleshooting

CAUTION

This game uses complex electronic components that are very sensitive to static electricity. Observe precautions below before handling these electronics. Failure to do so may void the warranty and damage electronic assemblies.

Before servicing electronics, turn off AC power to the game. Wait for capacitors to discharge.

DO NOT remove any of the components on the main board (e.g. hard drive and eproms) while the game is powered on. This may cause permanent damage to the parts and the main board.

Before touching or handling electronic assemblies, discharge static electricity on your body. To discharge this static, begin by connecting the line cord to a grounded outlet. Don't turn on the game. Next, touch the safety ground stud of the power supply chassis.

Store electronic assemblies in an anti-static area. Use anti-static bags to store or transport the game circuit boards.

Don't remove or connect electronic assemblies when cabinet power is on. Otherwise, you'll damage electronic assemblies and void the game's warranty.

After you complete maintenance or service, replace ground wires, shields, safety covers and install and tighten ground and mounting screw.

Video game monitors generate and store potentially high voltages. Avoid touching any part of the monitor until power has been off for some time. A picture tube can maintain a hazardous charge for up to several days. Only qualified technicians should service monitors.

Game Is Non-Functional

1.	Verify that the game power switch is turned on.
2.	Verify the line cord connector is firmly and correctly seated into the power entry module of AC power chassis.
3.	Verify that correct AC line voltage is present at the outlet
4.	Verify that the JAMMA wire harness connector is firmly and properly seated to the mating JAMMA PCB edge connector. DO NOT remove or install JAMMA connector when power is turned on. Doing so will damage the CPU assembly and void the warranty.
5.	Verify that the DC power supply voltages at the game CPU assembly are set as follows. The following voltages should be set when the game CPU assembly is connected and the game is powered on. +5V: +4.9V - +5.1V /// +12V: +11.5V - +12.5V //// -5V:-4.75V - -5.25V
6.	Verify that the non-JAMMA connectors are attached at the proper location and are firmly seated.
7.	Verify that the game DIP switches are set properly.
8.	Inspect CPU board under low-light conditions. LED's glow if processor circuits receive voltage. These indications prove presence of some DC from power supply. Still, voltages or signals may not be present.

Monitor Is Non-Functional

1.	Verify that the cabinet AC line voltage cable is firmly and properly connected to mating AC connector on monitor.
2.	Verify that the cabinet video signal cable connector is firmly and properly connected to the mating video signal input connector of the monitor.
3.	Verify that the monitor remote adjustment board is properly installed and connected to the monitor chassis.
4.	Verify monitor is operating properly by replacing with know good unit.
5.	Verify that brightness and contrast are set above their minimum levels.
6.	Verify that the DIP switches are set for the type of monitor you are using.

Sound Is Non-Functional

1.	Verify the cabinet wiring is correct. Ensure that the speakers are properly connected to the
2.	Verify that the power is providing: +5VDC @ 6 Amps (min) -5VDC @ 0.1 Amps (min) +12VDC @ 3 Amps (min)
3.	Verify that the above listed voltages are present at the correct JAMMA connector pins.
4.	Verify that the game volume has been turned up.

Game Controls Are Non-Functional

1.	Verify that the each individual switch is working by doing the SWITCH INPUT TEST under the SYSTEM TESTS MENU.
2.	Verify that the each individual signal wire for each switch is connected.

Marquee Lamp Is Non-Functional

1.	Verify that the fluorescent lamp is properly inserted into the lamp holders.
2.	Verify that the lamp pins are making good contact with the mating pins of the lamp holders.
3.	Verify that the fluorescent lamp ballast is correct for the local AC line voltage and frequency.

JAMMA Harness Connection Table

COMPONENT SIDE			SOLDER SIDE		
Ground	1		Ground	A	
Ground	2		Ground	B	
+ 5 Volts	3		+ 5 Volts	C	
+ 5 Volts	4		+ 5 Volts	D	
- 5 Volts	5		- 5 Volts	E	
+ 12 Volts	6		+ 12 Volts	F	
KEY	7		KEY	H	
Meter 1	8		Meter 2	J	
NC	9		NC	K	
Speaker +	10		Left Speaker -	L	
Speaker +	11		Right Speaker -	M	
Red Video	12		Green Video	N	
Blue Video	13		Composite Sync	P	
Video Ground	14		Service	R	ADD WIRE
Test	15	ADD WIRE	Tilt	S	
Coin 1	16	ADD WIRE	Coin 2	T	ADD WIRE
Player 1 Start	17		Player 2 Start	U	
Player 1 Select	18		Player 2 Up	V	
Player 1 Down	19		Player 2 Down	W	
Player 1 Left	20		Player 2 Left	X	
Player 1 Right	21		Player 2 Right	Y	
Player 1 Button 1	22		Player 2 Button 1	Z	
Player 1 Button 2	23		Player 2 Button 2	a	
Player 1 Button 3	24		Player 2 Button 3	b	
Player 1 Button 4	25		Player 2 Button 4	c	
NC	26		NC	d	
Ground	27		Ground	e	
Ground	28		Ground	f	

Chapter 7 – Parts

MECHANICAL PARTS

5001	Coin Door
AH2010	Gun (Recoil) Red
AH2011	Gun (Recoil) Blue
HR2005	Button – Large Round White
PT1050	Holster Cup
SP1010	Mounting Plate
CK1019	Leveler Foot
UB3028	Front Glass

ELECTRICAL PARTS

8312	Bulb PL-L
8449	Ballast
8715AHX	Hard Drive
AH2012	Power Supply
AH2035X	PCB (Gun)
AH2054KX	Harness (Gun)
AH2055KX	Harness (Coil PCB Power)
AH2056KX	Harness (Coil PCB Input)
AH2057KX	Harness (Power Supply Mains)
AR2007	Speaker (6 X 9)
MON29C	Monitor – 29"
SP2020	Cable - IDE
SP2034AHX	PCB (Main)
SP2053X	Harness (Hard Drive Power)
UC2010	Power Supply

GRAPHICS & DECALS

AH7001K	Decal – Cabinet Side (Left & Right Set)
AH7005	Decal – Button (Start Player 1)
AH7006	Decal – Button (Start Player 2)
AH7010	Decal – Bezel
AH7012K	Decal – Control Panel (Kit Only)
AH7027K	Decal – Marquee (Kit Only)
AH9001	Service Manual
AH9001A	Installation Templates
SP7003	Decal (Remove Hard Drive)

Chapter 8 - Warranty

I.C.E warrants all components in the **ACTION HERO™** game to be free of defects in materials and workmanship for a period of 90 days from the date of purchase. Furthermore, all MAIN P.C. BOARDS are warranted for 180 days.

This warranty does not cover items damaged due to normal wear and tear, subjected to abuse, improperly assembled by the end user, modified, repaired, or operated in a fashion other than that described in the service manual.

If your **ACTION HERO™** game fails to conform to the above-mentioned warranty, I.C.E.'s sole responsibility shall be at its discretion to repair or replace any defective component with a new or remanufactured component of equal to or greater O.E.M. specification.

I.C.E. will assume no liability whatsoever, for costs associated with labor to replace defective parts, or travel time associated therein.

I.C.E.'s obligation will be to ship free of charge, replacement parts by U.P.S. Ground, U.S. mail, or other comparable shipping means. Any express mail or overnight shipping expense is at the cost of the purchaser.

§ Products will be covered under warranty only when:

§ The serial number of the game with the defective parts is given.

§ The serial number of the defective part, if applicable, is given.

§ Defective parts are returned to I.C.E., shipping pre-paid, in a timely fashion, if requested by I.C.E.

§ A copy of the sales receipt is available as proof of purchase upon request of I.C.E.

I.C.E. distributors are independent, privately owned and operated. In their judgment, they may sell parts or accessories other than those manufactured by I.C.E. We cannot be responsible for the quality, suitability, or safety of any non-I.C.E. part, or any modification, including labor, which is performed by such a distributor.

I.C.E. Parts/Service Dept.
Innovative Concepts in Entertainment
10123 Main St.
Clarence, NY 14031
Phone #: (716) - 759 – 0360
Fax #: (716) – 759 – 0884